

Wenger® Business Gear 2018

125 SINCE 1893
A SWISS COMPANY



 **WENGER**®

wenger.ch

Summary

Backpacks	4
Laptop Cases	22
Tablet / E-Reader Cases	30
Sleeves	34
Slim Cases	38
Wheeled Cases	42
Women's Cases	46
Personalization	50
Features Description	52

This catalogue features branding and business gift guidelines/specifications

125 SINCE 1893
A SWISS COMPANY

WENGER – 125 YEARS OF SWISS INDUSTRIAL HISTORY

Dynamic, contemporary and at home in the world's cities – but always with its traditional Swiss roots in mind. In 2018, the Wenger brand celebrates 125 years in business and can look back on an eventful history. Founded near Delémont in the canton of Jura in 1893, the company was – along with Victorinox – one of the two exclusive manufacturers of the world-famous Swiss army knife. Today, the brand, which has been owned by Victorinox since 2005, produces and distributes watches and travel gear for business and private travellers. Wenger's products are reliable, functional and well-designed, and they capture the spirit of the times. They are designed for people who travel a lot and therefore want to count on a Swiss brand.

WENGER – 125 JAHRE SCHWEIZER INDUSTRIEGESCHICHTE

Dynamisch, zeitgemäss und in den Metropolen dieser Welt zu Hause – aber immer auf die traditionellen Schweizer Wurzeln bedacht. Die Marke Wenger feiert 2018 sein 125-jähriges Bestehen und blickt auf eine bewegte Geschichte zurück. 1893 bei Delémont im Kanton Jura gegründet, fertigte das Unternehmen neben Victorinox als einziger Hersteller das welt-berühmte „Swiss Army Knife“. Heute produziert und vertreibt die Marke, die seit 2005 zu Victorinox gehört, Uhren und Reisegepäck für Geschäfts- und Privatreisende. Die Produkte von Wenger sind zuverlässig, funktional, gut durchdacht und verkörpern den aktuellen Zeitgeist. Sie richten sich an Menschen, die viel unterwegs sind und sich dabei auf eine Schweizer Marke verlassen wollen.

Backpacks



125 SINCE 1893
SPECIAL EDITION

WENGER



125 SINCE 1893
SPECIAL EDITION

3Y WARRANTY



Ibex

- 17" Laptop Backpack with Tablet Pocket
- Triple Protect padded 17" laptop compartment and dedicated tablet pocket
 - CaseBase stabilizing platform keeps bag standing upright
 - Air-flow back padding to keep you cool
 - Shock-absorbing shoulder straps

- 17" Laptop-Rucksack mit Tablet-Fach
- Gepolstertes Triple Protect-Fach für 17" Laptop und separates Tablet-Fach
 - CaseBase, die Stabilisierungsplattform für einen stabilen und sicheren Stand des Rucksacks
 - Atmungsaktives Rückenpolster
 - Stossdämpfende Schulterriemen

37w x 47h x 26d cm | 14.6" w x 18.5" h x 10.2" d
1.6 kg | 3.53 lbs 23 l | 1404 cu in

■ | Black | Schwarz



3Y WARRANTY



StreetFlyer

- 16" Laptop Backpack with Tablet Pocket
- Essentials organizer
 - Comfort-fit shoulder straps
 - Pass-Thru trolley strap slides over the handle of wheeled luggage for easy travel with multiple bags

- 16" Laptop-Rucksack mit Tablet-Fach
- Organizer für wichtige Accessoires
 - Comfort-fit Schulterriemen
 - Tragegurt zur Befestigung am Griff von Rollenkoffern für komfortables Reisen mit mehreren Gepäckstücken

30w x 45h x 25d cm | 11.8" w x 17.7" h x 9.8" d
0.74 kg | 1.63 lbs 24 l | 1465 cu in

■ | Denim | Denim | 602657



PERSONALIZATION

INGOT PLAKETTE

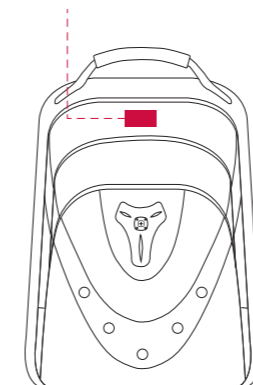

EMBROIDERY STICKEREIEN

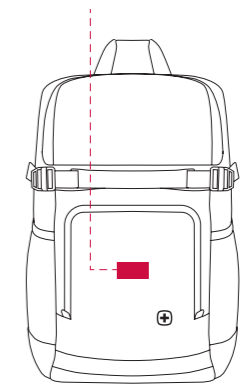

WENGER

wenger.ch



3Y WARRANTY

WaveLength

- 16" Laptop Backpack with Tablet Pocket
- Essentials organizer
- Comfort-fit shoulder straps
- Pass-Thru trolley strap slides over the handle of wheeled luggage for easy travel with multiple bags
- 16" Laptop-Rucksack mit Tablet-Fach
- Organizer für wichtige Accessoires
- Comfort-fit Schulterriemen
- Tragegurt zur Befestigung am Griff von Rollenkoffern für komfortables Reisen mit mehreren Gepäckstücken

33w x 46h x 28d cm | 13.0"w x 18.1"h x 11.0"d
0.74 kg | 1.63 lbs 28 l | 1709 cu in

■ | Grey Design | Graues Design | 602658



3Y WARRANTY

Cobalt

- 16" Laptop Backpack
- Triple Protect padded compartment protects up to a 16" laptop
- CaseBase stabilizing platform keeps bag standing upright
- Air-flow back padding and comfort-fit shoulder straps
- Essentials organizer

- 16" Laptop-Rucksack
- Gepolstertes "Triple Protect"-Fach für bis zu 16" Laptop
- CaseBase, die Stabilisierungsplattform für einen stabilen und sicheren Stand des Rucksacks
- Atmungsaktives Rückenpolster und Comfort-fit Schulterriemen
- Organizer für wichtige Accessoires

35w x 46h x 23d cm | 13.8"w x 18.1"h x 9.1"d
1.15 kg | 2.54 lbs 23 l | 1404 cu in

■ | Blue | Blau | 600629



3Y WARRANTY

Fuse

- 15.6" Laptop Backpack with Tablet Pocket
- Padded 15.6" laptop compartment and protective neoprene 10" tablet pocket
- Comfort-fit shoulder straps
- Essentials organizer
- 15.6" Laptop-Rucksack mit Tablet-Fach
- Gepolstertes Fach für einen 15,6" Laptop und 10" Tablet-Fach aus schützendem Neopren
- Comfort-fit Schulterriemen
- Organizer für wichtige Accessoires

32w x 43h x 21d cm | 12.6"w x 16.9"h x 8.3"d
0.87 kg | 1.92 lbs 16 l | 976 cu in

■ | Black | Schwarz | 600630



3Y WARRANTY

Pillar

- 16" Laptop Backpack
- Triple Protect padded compartment protects up to a 16" laptop
- CaseBase stabilizing platform keeps bag standing upright
- Air-flow back padding and comfort-fit shoulder straps
- Essentials organizer

- 16" Laptop-Rucksack
- Gepolstertes "Triple Protect"-Fach für bis zu 16" Laptop
- CaseBase, die Stabilisierungsplattform für einen stabilen und sicheren Stand des Rucksacks
- Atmungsaktives Rückenpolster und Comfort-fit Schulterriemen
- Organizer für wichtige Accessoires

38w x 48h x 25d cm | 15"w x 18.9"h x 9.8"d
1.11 kg | 2.45 lbs 25 l | 1526 cu in

■ ■ | Black / Grey | Schwarz / Grau | 600633



PERSONALIZATION

INGOT PLAKETTE

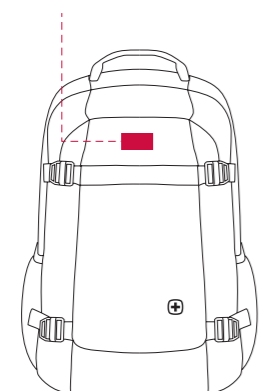

INGOT PLAKETTE

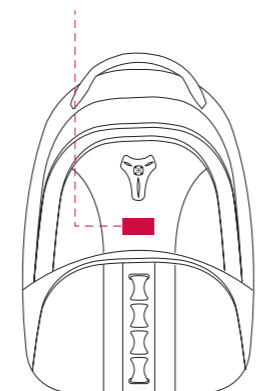

INGOT PLAKETTE

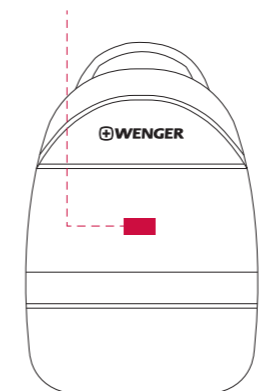

EMBROIDERY STICKEREIEN

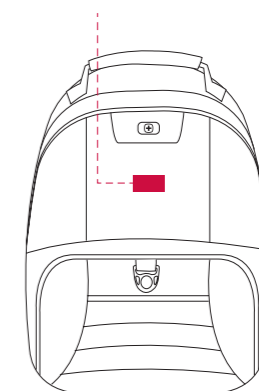



3Y WARRANTY

16" 41 cm

12.9" 32 cm

AIR FLOW

RFID SECURE

Quick Pocket

RFID Protection

Air-flow padding

Shoulder straps

Padded compartment

CityFriend

- 16" Laptop Backpack with Tablet Pocket
- Quick Pocket for easy access to essentials
- RFID protection pocket
- Air-flow back padding and comfort-fit shoulder straps
- Padded compartment for up to a 16" laptop

- 16" Laptop-Rucksack mit Tablet-Fach
- Quick Pocket für leichten Zugang auf Ihre persönlichen Dinge
- Tasche mit RFID-Schutz
- Gepolstertes Fach für bis zu 16" Laptop
- Abschliessbare Reissverschlüsse

29w x 43h x 21d cm | 11.4"w x 16.9"h x 8.3"d
0.71 kg | 1.57 lbs | 19 l | 1159 cu in

■ | Black | Schwarz | 602809



7|613329 |049495



3Y WARRANTY

16" 41 cm

12.9" 32 cm

AIR FLOW

Quick Pocket

Essentials organizer

Shoulder straps

Bottom compartment

Jetty

- 16" Laptop Backpack with Tablet Pocket
- Essentials organizer
- Comfort-fit shoulder straps
- Separate bottom zippered compartment provides additional packing space and easy access

- 16" Laptop-Rucksack mit Tablet-Fach
- Organizer für wichtige Accessoires
- Comfort-fit Schulterriemen
- Leicht zugängliches, separates Bodenfach mit Reissverschluss für zusätzlichen Stauraum

31w x 51h x 27d cm | 12.2"w x 20.1"h x 10.6"d
0.88 kg | 1.94 lbs | 25 l | 1526 cu in

■ | Purple | Lila | 602659



7|613329 |048788



3Y WARRANTY

16" 41 cm

12.9" 32 cm

AIR FLOW

Quick Pocket

Essentials organizer

Shoulder straps

CaseBase platform

Lycus

- 16" Laptop Backpack with Tablet Pocket
- Essentials organizer
- Comfort-fit shoulder straps
- CaseBase stabilizing platform keeps bag standing upright

- 16" Laptop-Rucksack mit Tablet-Fach
- Organizer für wichtige Accessoires
- Comfort-fit Schulterriemen
- CaseBase, die Stabilisierungsplattform für einen stabilen und sicheren Stand des Rucksacks

33w x 46h x 26d cm | 13.0"w x 18.1"h x 10.2"d
1.06 kg | 2.33 lbs | 25 l | 1526 cu in

■ ■ | Blue / Grey | Blau / Grau | 602660

AIR FLOW

Quick Pocket

Essentials organizer

Shoulder straps

CaseBase platform



7|613329 |048795



3Y WARRANTY

16" 41 cm

12.9" 32 cm

AIR FLOW

Quick Pocket

Essentials organizer

Shoulder straps

CaseBase platform

Enyo

- 16" Laptop Backpack with Tablet Pocket
- Essentials organizer
- Comfort-fit shoulder straps
- CaseBase stabilizing platform keeps bag standing upright

- 16" Laptop-Rucksack mit Tablet-Fach
- Organizer für wichtige Accessoires
- Comfort-fit Schulterriemen
- CaseBase, die Stabilisierungsplattform für einen stabilen und sicheren Stand des Rucksacks

33w x 45h x 26d cm | 12.8"w x 17.7"h x 10.2"d
1.10 kg | 2.42 lbs | 23 l | 1403 cu in

■ ■ | Blue / Grey | Blau / Grau | 602662

AIR FLOW

Quick Pocket

Essentials organizer

Shoulder straps

CaseBase platform



7|613329 |048818

PERSONALIZATION

EMBROIDERY STICKEREIEN

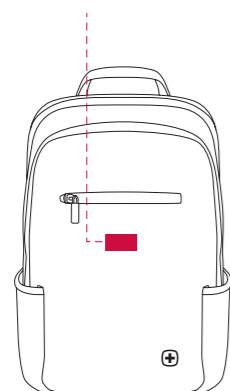

EMBROIDERY STICKEREIEN

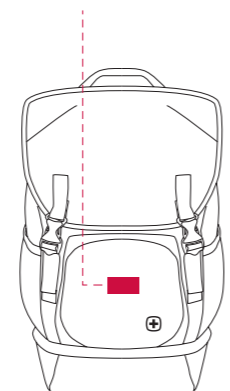

INGOT PLAKETTE

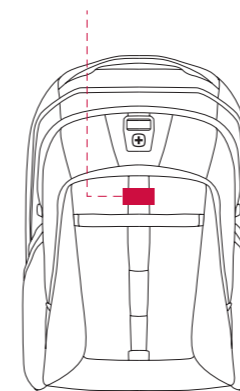

INGOT PLAKETTE

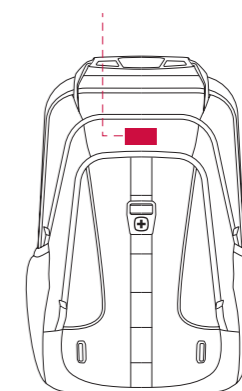



3Y WARRANTY

16" 41 cm

12.9" 33 cm

AIR FLOW

AIR FLOW

AIR FLOW

AIR FLOW

Ero

- 16" Laptop Backpack with Tablet Pocket
- Padded 16" laptop compartment and dedicated tablet pocket
- Interior mesh accessories pocket
- Comfort-fit shoulder straps
- Mesh side pockets

- 16" Laptop-Rucksack mit Tablet-Fach
- Gepolstertes Fach für 16" Laptop und separates Tablet-Fach
- Internes Zubehörfach aus Netzmaterial
- Comfort-fit Schulterriemen
- Netz-Seitentaschen

30w x 44h x 15d cm | 11.8"w x 17.3"h x 5.9"d
0.67 kg | 1.48 lbs 22 l | 1343 cu in

■ | Denim | Denim | 602655



71613329 1048740



3Y WARRANTY

16" 41 cm

12.9" 33 cm

AIR FLOW

AIR FLOW

AIR FLOW

AIR FLOW

AIR FLOW

AIR FLOW

AIR FLOW

AIR FLOW

AIR FLOW

Priam

- 16" Laptop Backpack with Tablet Pocket
- Water-repellent exterior
- Comfort-fit shoulder straps
- CaseBase stabilizing platform keeps bag standing upright

- 16" Laptop-Rucksack mit Tablet-Fach
- Wasserabweisende Aussenseite
- Comfort-fit Schulterriemen
- CaseBase, die Stabilisierungsplattform für einen stabilen und sicheren Stand des Rucksacks

33w x 44h x 25d cm | 13.0"w x 17.3"h x 9.8"d
1.12 kg | 2.46 lbs 24 l | 1464 cu in

■ | Green | Grün | 602661



71613329 1048801



3Y WARRANTY

15.6" 40 cm

10" 25 cm

AIR FLOW

AIR FLOW

AIR FLOW

AIR FLOW

AIR FLOW

AIR FLOW

AIR FLOW

AIR FLOW

AIR FLOW

Surge

- 15.6" Laptop Backpack with Tablet Pocket
- Padded 15.6" laptop compartment and protective neoprene 10" tablet pocket
- Comfort-fit shoulder straps
- Essentials organizer

- 15.6" Laptop-Rucksack mit Tablet-Fach
- Gepolstertes Fach für einen 15.6" Laptop und 10" Tablet-Fach aus schützendem Neopren
- Comfort-fit Schulterriemen
- Organizer für wichtige Accessoires

33w x 43h x 18d cm | 13"w x 16.9"h x 7.1"d
0.88 kg | 1.94 lbs 13 l | 793 cu in

■ | Black | Schwarz | 600634



71613329 1007921



3Y WARRANTY

16" 41 cm

10" 25 cm

AIR FLOW

AIR FLOW

AIR FLOW

AIR FLOW

AIR FLOW

AIR FLOW

AIR FLOW

AIR FLOW

AIR FLOW

Transit

- 16" Deluxe Laptop Backpack with Tablet Pocket
- Padded 16" laptop compartment and dedicated tablet pocket
- CaseBase stabilizing platform keeps bag standing upright
- Air-flow back padding to keep you cool
- Essentials organizer

- 16" Deluxe Laptop-Rucksack mit Tablet-Fach
- Gepolstertes Fach für 16" Laptop und separates Tablet-Fach
- CaseBase, die Stabilisierungsplattform für einen stabilen und sicheren Stand des Rucksacks
- Atmungsaktives Rückenpolster
- Organizer für wichtige Accessoires

35w x 46h x 27d cm | 13.8"w x 18.1"h x 10.6"d
1.05 kg | 2.31 lbs 27 l | 1648 cu in

■ | Black | Schwarz | 600636



71613329 1007945

PERSONALIZATION

THERMAL TRANSFER PRINT
THERMOTRANSFERDRUCK

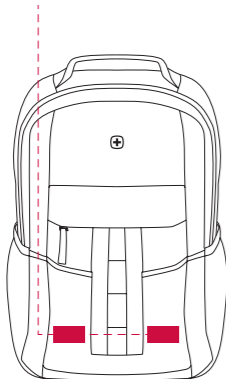

EMBROIDERY
STICKEREIEN

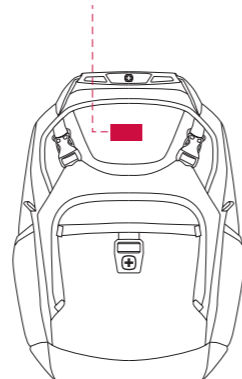

EMBROIDERY
STICKEREIEN

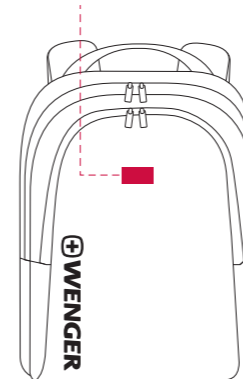

EMBROIDERY
STICKEREIEN

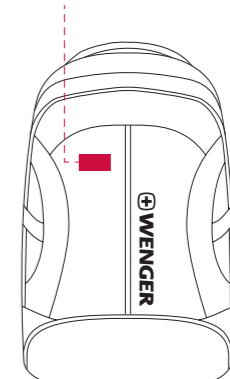



3Y
WARRANTY



Nanobyte

- 13" MacBook Pro Backpack with iPad Pocket
- Padded 13" MacBook Pro or MacBook Air compartment and dedicated iPad pocket with anti-scratch lining
- Air-flow back padding to keep you cool
- Essentials organizer

- 13" MacBook Pro Rucksack mit iPad-Fach
- Gepolstertes Fach für ein 13" MacBook Pro oder ein MacBook Air und separates iPad-Fach mit Anti-Kratz-Futter
- Atmungsaktives Rückenpolster
- Organizer für wichtige Accessoires

31w x 41h x 23d cm | 12.2"w x 16.1"h x 9.1"d
0.9 kg | 1.98 lbs 15 | 915 cu in

■ | Black / Grey | Schwarz / Grau | 600626



7|613329 |007846



3Y
WARRANTY



Legacy

- 16" Laptop Backpack
- Triple Protect padded compartment protects up to a 16" laptop
- CaseBase stabilizing platform keeps bag standing upright
- Air-flow back padding and comfort-fit shoulder straps

- 16" Laptop-Rucksack
- Gepolstertes "Triple Protect"-Fach für bis zu 16" Laptop
- CaseBase, die Stabilisierungsplattform für einen stabilen und sicheren Stand des Rucksacks
- Atmungsaktives Rückenpolster und Comfort-fit Schulterriemen

35w x 45h x 25d cm | 13.8"w x 17.7"h x 9.8"d
1.49 kg | 3.28 lbs 21 | 1282 cu in

■ | Black / Grey | Schwarz / Grau | 600631



7|613329 |007891



3Y
WARRANTY



Mythos

- 16" Laptop Backpack
- Triple Protect padded compartment protects up to a 16" laptop
- CaseBase stabilizing platform keeps bag standing upright
- Air-flow back padding and comfort-fit shoulder straps
- Essentials organizer

- 16" Laptop-Rucksack
- Gepolstertes "Triple Protect"-Fach für bis zu 16" Laptop
- CaseBase, die Stabilisierungsplattform für einen stabilen und sicheren Stand des Rucksacks
- Atmungsaktives Rückenpolster und Comfort-fit Schulterriemen
- Organizer für wichtige Accessoires

37w x 47h x 26d cm | 14.6"w x 18.5"h x 10.2"d
1.33 kg | 2.93 lbs 27 | 1648 cu in

■ | Blue | Blau | 600632



7|613329 |007907



3Y
WARRANTY



Reload 14

- 14" Laptop Backpack with Tablet Pocket
- Padded 14" laptop compartment and dedicated 10" tablet pocket with anti-scratch lining
- Essentials organizer

- 14" Laptop-Rucksack mit Tablet-Fach
- Gepolstertes Fach für einen 14" Laptop und separates 10" Tablet-Fach mit Anti-Kratz-Futter
- Organizer für wichtige Accessoires

28w x 42h x 17d cm | 11"w x 16.5"h x 6.7"d
0.88 kg | 1.94 lbs 11 | 671 cu in

■ | Black | Schwarz | 601068
■ | Grey | Grau | 601069



7|613329 |014462



7|613329 |014455

PERSONALIZATION

INGOT PLAKETTE

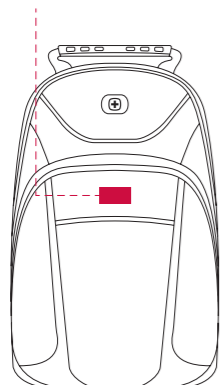

INGOT PLAKETTE

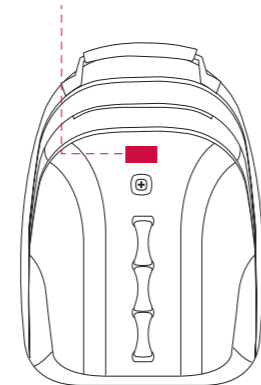

INGOT PLAKETTE

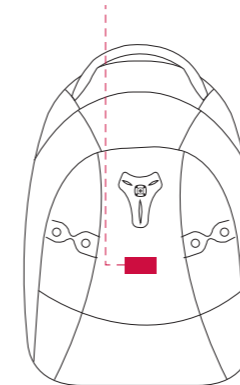

EMBROIDERY STICKEREIEN

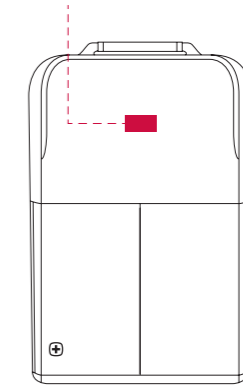



3Y
WARRANTY

16"
41 cm

10"
25 cm



Sidebar

- 16" Deluxe Laptop Backpack with Tablet Pocket
- Padded 16" laptop compartment and dedicated 10" tablet pocket
- CaseBase stabilizing platform keeps bag standing upright
- Essentials organizer

- 16" Deluxe Laptop-Rucksack mit Tablet-Fach
- Gepolstertes Fach für einen 16" Laptop und ein separates 10" Tablet-Fach
- CaseBase, die Stabilisierungsplattform für einen stabilen und sicheren Stand des Rucksacks
- Organizer für wichtige Accessoires

37w x 45h x 26d cm | 14.6"w x 17.7"h x 10.2"d
0.89 kg | 1.96 lbs 25 l | 1526 cu in

■ | Black | Schwarz | 601468



71613329 1036709

3Y
WARRANTY

16"
41 cm

12.9"
32 cm



SkyPort

- 16" Laptop Backpack with Tablet Pocket
- Quick Pocket for easy access to essentials
- RFID protection pocket
- Triple Protect padded compartment protects up to a 16" laptop

- 16" Laptop-Rucksack mit Tablet-Fach
- Quick Pocket für leichten Zugang auf Ihre persönlichen Dinge
- RFID-Schutztasche
- Gepolstertes "Triple Protect"-Fach für bis zu 16" Laptop

31w x 46h x 28d cm | 12.2"w x 18.1"h x 11.0"d
0.92 kg | 2.03 lbs 26 l | 1587 cu in

■ | Black | Schwarz | 602806



71613329 1049464

3Y
WARRANTY

16"
41 cm

12.9"
32 cm



CityGo

- 16" Laptop Backpack with Tablet Pocket
- Quick Pocket for easy access to essentials
- RFID protection pocket
- Triple Protect padded compartment protects up to a 16" laptop

- 16" Laptop-Rucksack mit Tablet-Fach
- Quick Pocket für leichten Zugang auf Ihre persönlichen Dinge
- RFID-Schutztasche
- Gepolstertes "Triple Protect"-Fach für bis zu 16" Laptop

31w x 46h x 26d cm | 12.2"w x 18.1"h x 10.2"d
0.90 kg | 1.98 lbs 23 l | 1404 cu in

■ | Grey | Grau | 602807



71613329 1049471

3Y
WARRANTY

16"
41 cm

12.9"
32 cm



CityRock

- Convertible 16" Laptop Backpack/Business Case with Tablet Pocket
- Quick Pocket for easy access to essentials
- RFID protection pocket
- Triple Protect padded compartment protects up to a 16" laptop

- Zweifach verwendbarer 16" Laptop-Rucksack und Business-Case mit Tablet-Fach
- Quick Pocket für leichten Zugang auf Ihre persönlichen Dinge
- RFID-Schutztasche
- Gepolstertes "Triple Protect"-Fach für bis zu 16" Laptop

31w x 41h x 23d cm | 12.2"w x 16.1"h x 9.1"d
0.98 kg | 2.16 lbs 21 l | 1281 cu in

■ | Navy | Blau | 602811



71613329 1049518

PERSONALIZATION

EMBROIDERY STICKEREIEN

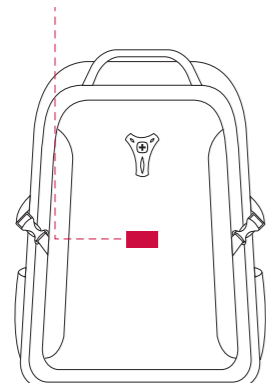

EMBROIDERY STICKEREIEN

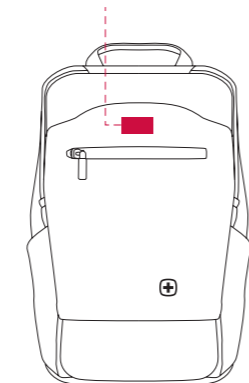

EMBROIDERY STICKEREIEN

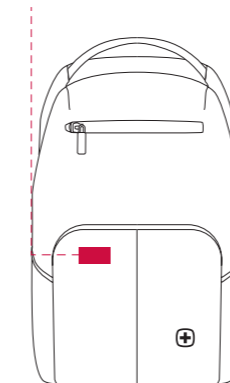

THERMAL TRANSFER PRINT THERMOTRANSFERDRUCK

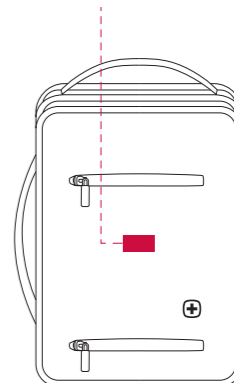



3Y WARRANTY

Gigabyte

- 15" MacBook Pro Backpack with iPad Pocket
- Padded 15" MacBook Pro compartment and dedicated iPad pocket feature anti-scratch lining
- CaseBase stabilizing platform keeps bag standing upright
- Shock-absorbing shoulder straps
- Essentials organizer

- 15" MacBook Pro Rucksack mit iPad-Fach
- Gepolstertes Fach für ein 15" MacBook Pro und separates iPad-Fach mit Anti-Kratz-Futter
- CaseBase, die Stabilisierungsplattform für einen stabilen und sicheren Stand des Rucksacks
- Stossdämpfende Schulterriemen
- Organizer für wichtige Accessoires

34w x 45h x 21d cm | 13.4"w x 17.7"h x 8.3"d
1.04 kg | 2.29 lbs 17 l | 1037 cu in

■ | Black | Schwarz | 600627



7|613329 |007853



3Y WARRANTY

Reload 16

- 16" Laptop Backpack with Tablet Pocket
- Padded 16" laptop compartment and dedicated 10" tablet pocket with anti-scratch lining
- Essentials organizer
- Pass-Thru trolley sleeve slides over the handle of wheeled luggage for easy travel with multiple bags

- 16" Laptop-Rucksack mit Tablet-Fach
- Gepolstertes Fach für einen 16" Laptop und separates 10" Tablet-Fach mit Anti-Kratz-Futter
- Organizer für wichtige Accessoires
- Trageschleife zur Befestigung am Griff von Rollengepäck für komfortables Reisen mit mehreren Gepäckstücken

31w x 44h x 18d cm | 12.2"w x 17.3"h x 7.1"d
1.12 kg | 2.47 lbs 16 l | 976 cu in

■ | Black | Schwarz | 601070
■ | Grey | Grau | 601071



7|613329 |014523 7|613329 |014516



3Y WARRANTY

Pegasus 15

- 15" MacBook Pro Backpack with iPad Pocket
- Padded compartments with anti-scratch lining for a 15" MacBook Pro and iPad
- Air-flow back padding to keep you cool
- Essentials organizer

- 15" MacBook Pro Rucksack mit iPad-Fach
- Gepolsterte Fächer mit Anti-Kratz-Futter für ein 15" MacBook Pro und ein iPad
- Atmungsaktives Rückenpolster
- Organizer für wichtige Accessoires

34w x 42h x 24d cm | 13.4"w x 16.5"h x 9.4"d
1.26 kg | 2.78 lbs 17 l | 1037 cu in

■ | Blue | Blau | 600625



7|613329 |007693



3Y WARRANTY

Synergy

- 16" Laptop Backpack with Tablet Pocket
- Triple Protect padded 16" laptop compartment and dedicated tablet pocket
- CaseBase stabilizing platform keeps bag standing upright
- Air-flow back padding to keep you cool
- Shock-absorbing shoulder straps

- 16" Laptop-Rucksack mit Tablet-Fach
- Gepolstertes Triple Protect-Fach für 16" Laptop und separates Tablet-Fach
- CaseBase, die Stabilisierungsplattform für einen stabilen und sicheren Stand des Rucksacks
- Atmungsaktives Rückenpolster
- Stossdämpfende Schulterriemen

36w x 46h x 26d cm | 14.2"w x 18.1"h x 10.2"d
1.6 kg | 3.53 lbs 26 l | 1587 cu in

■ ■ | Black / Grey | Schwarz / Grau | 600635



7|613329 |007938

PERSONALIZATION

INGOT PLAKETTE

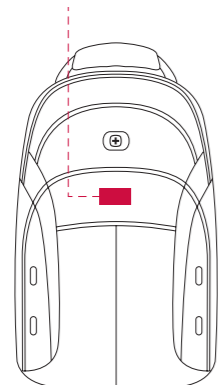

EMBROIDERY STICKEREIEN

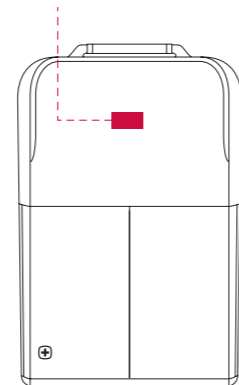

INGOT PLAKETTE

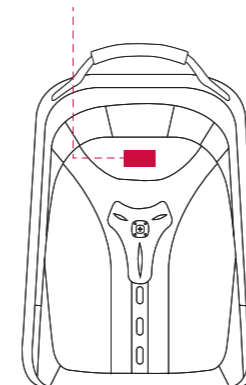

INGOT PLAKETTE

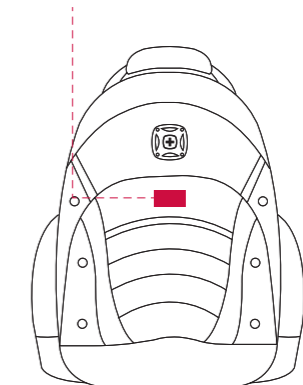



3Y
WARRANTY

Update

- 15" MacBook Pro Backpack with iPad Pocket
- Triple Protect padded 15" MacBook Pro compartment and dedicated padded iPad pocket both feature anti-scratch lining
- CaseBase stabilizing platform keeps bag standing upright
- Shock-absorbing shoulder straps
- Essentials organizer

- 15" MacBook Pro Rucksack mit iPad-Tasche
- Gepolstertes Fach mit Dreifachschutz für ein 15" MacBook Pro und separates gepolstertes iPad-Fach, beide mit Anti-Kratz-Futter
- CaseBase, die Stabilisierungsplattform für einen stabilen und sicheren Stand des Rucksacks
- Stossdämpfende Schulterriemen
- Organizer für wichtige Accessoires

33w x 44h x 26d cm | 13.0"w x 17.3"h x 10.2"d
1.33 kg | 2.93 lbs 20 l | 1220 cu in

■ ■ | Grey / Black | Grau / Schwarz | 600628



71613329 1007860



3Y
WARRANTY

Ibex

- 17" Laptop Backpack with Tablet Pocket
- Triple Protect padded 17" laptop compartment and dedicated tablet pocket
- CaseBase stabilizing platform keeps bag standing upright
- Air-flow back padding to keep you cool
- Shock-absorbing shoulder straps

- 17" Laptop-Rucksack mit Tablet-Fach
- Gepolstertes Triple Protect-Fach für 17" Laptop und separates Tablet-Fach
- CaseBase, die Stabilisierungsplattform für einen stabilen und sicheren Stand des Rucksacks
- Atmungsaktives Rückenpolster
- Stossdämpfende Schulterriemen

37w x 47h x 26d cm | 14.6"w x 18.5"h x 10.2"d
1.6 kg | 3.53 lbs 23 l | 1404 cu in

■ | Blue | Blau | 600638



71613329 1007969



3Y
WARRANTY

Pegasus

- 17" Laptop Backpack
- Triple Protect padded 17" laptop compartment and dedicated tablet pocket
- CaseBase stabilizing platform keeps bag standing upright
- Air-flow back padding to keep you cool
- Shock-absorbing shoulder straps

- 17" Laptop-Rucksack mit Tablet-Fach
- Gepolstertes Triple Protect-Fach für 17" Laptop und separates Tablet-Fach
- CaseBase, die Stabilisierungsplattform für einen stabilen und sicheren Stand des Rucksacks
- Atmungsaktives Rückenpolster
- Stossdämpfende Schulterriemen

37w x 48h x 24d cm | 14.6"w x 18.9"h x 9.4"d
1.36 kg | 3.0 lbs 25 l | 1526 cu in

■ | Grey | Grau | 600639



71613329 1007976



3Y
WARRANTY

Arundel

- 16" Laptop Backpack with Tablet Pocket
- Quick Pocket for easy access to essentials
- Essentials organizer with anti-scratch lining
- Triple Protect padded compartment protects up to a 16" laptop
- Air-flow back padding keeps wearer cool

- 16" Laptop-Rucksack mit Tablet-Fach
- 16" Laptop-Rucksack mit Tablet-Fach
- Quick Pocket für leichten Zugang auf Ihre persönlichen Gegenstände
- Organizer mit kratzsicherem Futter
- Gepolstertes "Triple Protect"-Fach für bis zu 16" Laptop
- Atmungsaktives Rückenpolster

32w x 44h x 25d cm | 12.6"w x 17.3"h x 9.8"d
1.08 kg | 2.38 lbs 23 l | 1404 cu in

■ | Camel | Camel | 602830



71613329 1049624

PERSONALIZATION

INGOT PLAKETTE

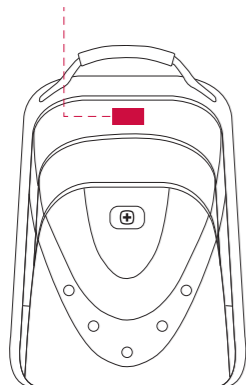

INGOT PLAKETTE

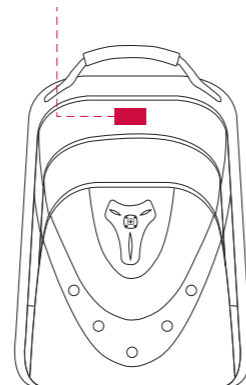

INGOT PLAKETTE

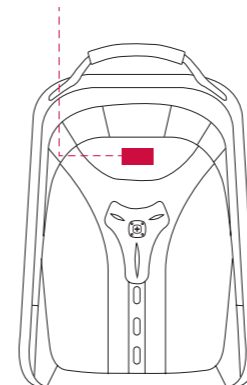

INGOT PLAKETTE

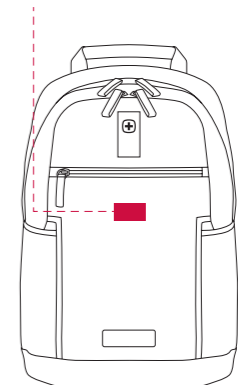



3Y WARRANTY



Carbon

- 17" MacBook Pro Backpack
- Padded compartment for up to a 17" MacBook Pro
 - CaseBase stabilizing platform keeps bag standing upright
 - Air-flow back padding to keep you cool
 - Shock-absorbing shoulder straps
 - Quick Pocket for easy access to essentials

- 17" MacBook Pro Rucksack
- Gepolstertes Fach für bis zu 17" MacBook Pro
 - CaseBase, die Stabilisierungsplattform für einen stabilen und sicheren Stand des Rucksacks
 - Atmungsaktives Rückenpolster
 - Stossdämpfende Schulterriemen
 - Schnellzugriffsfach für leichten Zugang auf Ihre persönlichen Gegenstände

34w x 50h x 29d cm | 13.4"w x 19.7"h x 11.4"d
1.5 kg | 3.31 lbs 30 l | 1830 cu in

■ | Black | Schwarz | 600637



71613329 1007952



3Y WARRANTY



CityPatrol

- Rolling 16" Laptop Backpack with Tablet Pocket
- Protective wheel cover and hideaway trolley handle
 - RFID protection pocket
 - Triple Protect padded compartment protects up to a 16" laptop
 - Air-flow back padding keeps wearer cool

- Rollfähiger 16" Laptop-Rucksack mit Tablet-Fach
- Rad-Schutzabdeckung und versenkbarer Trolleygriff
 - RFID-Schutztasche
 - Gepolstertes "Triple Protect"-Fach für bis zu 16" Laptop
 - Atmungsaktive Rückenpolsterung gegen Schwitzen

34w x 48h x 25d cm | 13.4"w x 18.9"h x 9.8"d
2.71 kg | 5.97 lbs 24 l | 1465 cu in

■ | Navy | Blau | 602810



71613329 1049501



3Y WARRANTY



CityDive

- 16" Laptop Backpack with Tablet Pocket
- RFID protection pocket
 - Quick Pocket for easy access to essentials
 - Triple Protect padded compartment protects up to a 16" laptop

- 16" Laptop-Rucksack mit Tablet-Fach
- RFID-Schutztasche
 - Quick Pocket für leichten Zugang auf Ihre persönlichen Dinge
 - Gepolstertes "Triple Protect"-Fach für bis zu 16" Laptop

32w x 46h x 27d cm | 12.6"w x 18.1"h x 10.6"d
0.94 kg | 2.07 lbs 27 l | 1648 cu in

■ | Navy | Blau | 602808



71613329 1049488

PERSONALIZATION

INGOT PLAKETTE

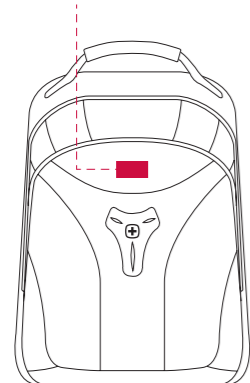

INGOT PLAKETTE

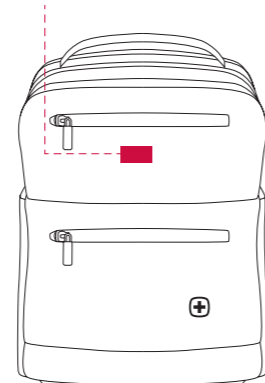

EMBROIDERY STICKEREIEN

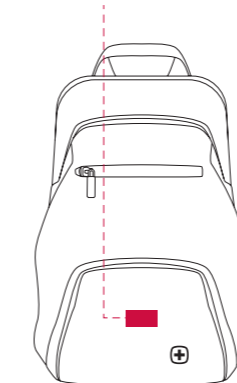

Laptop Cases



3Y
WARRANTY

15.6"
39 cm

10"
25 cm

10"
25 cm

10"
25 cm

10"
25 cm

10"
25 cm

10"
25 cm

10"
25 cm

10"
25 cm

Insight

15.6" Laptop Case

- Protection for up to a 15.6" laptop and 10" tablet
- Checkpoint-friendly to make getting through security easy
- Essentials organizer
- Pass-Thru trolley strap slides over the handle of wheeled luggage for easy travel with multiple bags

15,6" Laptop-Tasche

- Zuverlässiger Schutz für einen Laptop bis zu 15,6" und ein 10" Tablet
- Praktisch an Kontrollpunkten, vereinfacht Sicherheitsüberprüfungen
- Organizer für wichtige Accessoires
- Tragegurt zur Befestigung am Griff von Rollenkoffern für komfortables Reisen mit mehreren Gepäckstücken

41w x 31h x 14d cm | 16.1"w x 12.2"h x 5.5"d
1.17 kg | 2.58 lbs | 10 l | 610 lbs

■ | Grey | Grau | 600646



7|613329 |008041



3Y
WARRANTY

14"
35 cm

10"
25 cm

10"
25 cm

10"
25 cm

10"
25 cm

10"
25 cm

10"
25 cm

10"
25 cm

10"
25 cm

Source 14

14" Laptop Briefcase with Tablet Pocket

- Padded compartment with anti-scratch lining for up to a 14" laptop
- Essentials organizer features a 10" tablet pocket with anti-scratch lining
- File divider separates documents
- Pass-Thru trolley sleeve slides over the handle of wheeled luggage for easy travel with multiple bags

14" Laptop-Aktentasche mit Tablet-Fach

- Gepolstertes Fach mit Anti-Kratz-Futter für ein Laptop bis zu 14"
- Organizer mit 10" Tablet-Fach mit Anti-Kratz-Futter
- Aktenfächer zur getrennten Aufbewahrung von Dokumenten
- Trageschleife zur Befestigung am Griff von Rollengepäck für komfortables Reisen mit mehreren Gepäckstücken

39w x 25h x 8d cm | 15.4"w x 9.8"h x 3.1"d
0.74 kg | 1.63 lbs | 5 l | 305 cu in

■ | Black | Schwarz | 601064
■ | Grey | Grau | 601065



7|613329 |014424



7|613329 |014417

PERSONALIZATION

INGOT PLAKETTE

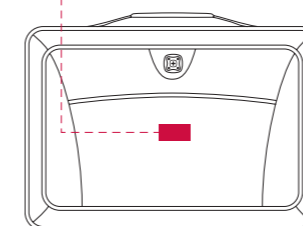

EMBROIDERY STICKEREIEN

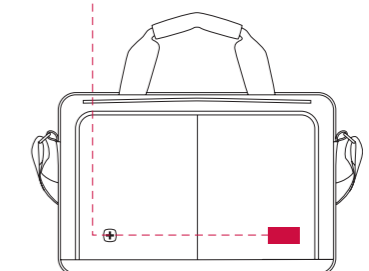



3Y WARRANTY



16" 41 cm

10" 25 cm



Source 16

- 16" Laptop Briefcase with Tablet Pocket
- Padded compartment with anti-scratch lining for up to a 16" laptop
- Essentials organizer features a 10" tablet pocket with anti-scratch lining
- File divider separates documents
- Quick Pocket for easy access to essentials

- 16" Laptop-Aktentasche mit Tablet-Fach
- Gepolstertes Fach mit Anti-Kratz-Futter für ein Laptop bis zu 16"
- Organizer mit 10" Tablet-Fach mit Anti-Kratz-Futter
- Aktenfächer zur getrennten Aufbewahrung von Dokumenten
- Schnellzugriffsfach für leichten Zugang auf Ihre persönlichen Gegenstände

41w x 28h x 12d cm | 16.1"w x 11"h x 4.7"d
0.99 kg | 2.18 lbs 8 l | 488 cu in

■ | Black | Schwarz | 601066
■ | Grey | Grau | 601067



3Y WARRANTY

17" 43 cm



Legacy

- 17" Laptop Case
- Checkpoint-friendly to make getting through security easy
- Triple Protect padded compartment protects up to a 17" laptop
- Fan file divider separates documents
- Essentials organizer

- 17" Laptop-Tasche
- Praktisch an Kontrollpunkten, vereinfacht Sicherheitsüberprüfungen
- Gepolstertes "Triple Protect"-Fach für bis zu 17" Laptop
- Abtrennungen für Dokumente
- Organizer für wichtige Accessoires

42w x 32h x 21d cm | 16.5"w x 12.6"h x 8.3"d
1.27 kg | 2.8 lbs 19 l | 1159 cu in

■ | Black / Grey | Schwarz / Grau | 600655



3Y WARRANTY



16" 41 cm

10" 25 cm



Underground

- 16" Laptop Briefcase with Tablet Pocket
- Padded 16" laptop compartment and dedicated 10" tablet pocket with anti-scratch lining
- Essentials organizer
- Pass-Thru trolley sleeve slides over the handle of wheeled luggage for easy travel with multiple bags

- 16" Laptop-Aktentasche mit Tablet-Fach
- Gepolstertes Fach für einen 16" Laptop und separates 10" Tablet-Fach mit Anti-Kratz-Futter
- Organizer für wichtige Accessoires
- Trageschleife zur Befestigung am Griff von Rollengepäck für komfortables Reisen mit mehreren Gepäckstücken

43w x 31h x 9d cm | 16.9"w x 12.2"h x 3.5"d
0.97 kg | 2.14 lbs 9 l | 549 cu in

■ | Black | Schwarz | 601057



3Y WARRANTY

16" 41 cm

12.9" 32 cm



CityStep

- 16" Laptop Slimcase with Tablet Pocket
- Quick Pocket for easy access to essentials
- RFID protection pocket
- Padded compartment for up to a 16" laptop
- Lockable zippers

- 16" Slimcase mit Tablet-Fach
- Quick Pocket für leichten Zugang auf Ihre persönlichen Dinge
- Tasche mit RFID-Schutz
- Gepolstertes Fach für bis zu 16" Laptop
- Abschliessbare Reissverschlüsse

42w x 31h x 16d cm | 16.5"w x 12.2"h x 6.3"d
0.66 kg | 1.46 lbs 15 l | 915 cu in

■ | Black | Schwarz | 602821



PERSONALIZATION

EMBROIDERY STICKEREIEN

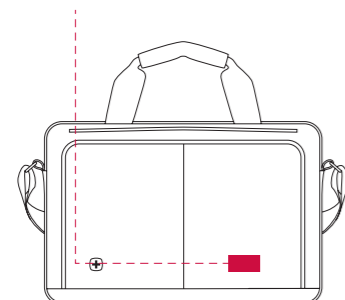

EMBROIDERY STICKEREIEN

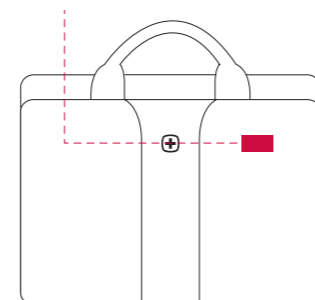

EMBROIDERY STICKEREIEN

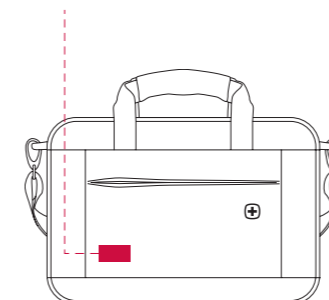

EMBROIDERY STICKEREIEN

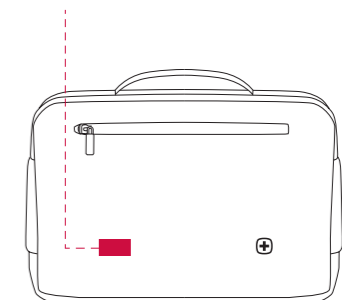



3Y WARRANTY

CityStream

- 16" Laptop Business Case with Tablet Pocket
- Quick Pocket for easy access to essentials
- RFID protection pocket
- Triple Protect padded compartment protects up to a 16" laptop
- 16" Laptop-Business Case mit Tablet-Fach
- Quick Pocket für leichten Zugang auf Ihre persönlichen Dinge
- RFID-Schutztasche
- Gepolstertes "Triple Protect"-Fach mit für bis zu 16" Laptop
- 43w x 30h x 23d cm | 16.9"w x 11.8"h x 9.1"d
- 0.80 kg | 1.76 lbs | 21 l | 1281 cu in
- | Black | Schwarz | 602820



71613329 049549



3Y WARRANTY

Legacy

- 16" Double-Gusset Laptop Briefcase
- Triple Protect padded compartment protects up to a 16" laptop
- Checkpoint-friendly to make getting through security easy
- Essentials organizer
- 16" Laptop-Aktentasche mit 2 Hauptfächern
- Gepolstertes Triple Protect-Fach für bis zu 16" Laptop
- Praktisch an Kontrollpunkten, vereinfacht Sicherheitsüberprüfungen
- Organizer für wichtige Accessoires
- 40w x 31h x 18d cm | 15.7"w x 12.2"h x 7.1"d
- 1.09 kg | 2.4 lbs | 15 l | 915 cu in
- ■ | Black / Grey | Schwarz / Grau | 600648



71613329 008065



3Y WARRANTY

SunScrapper

- Double Flap Over 16" Laptop Business Case with Tablet Pocket
- Quick Pocket for easy access to essentials
- RFID protection pocket
- Triple Protect padded compartment protects up to a 16" laptop / Lockable zippers
- Doppelt umklappbares 16" Laptop-Business Case mit Tablet-Fach
- Quick Pocket für leichten Zugang auf Ihre persönlichen Dinge
- RFID-Schutztasche
- Gepolstertes "Triple Protect"-Fach mit für bis zu 16" Laptop / Abschliessbare Reissverschlüsse
- 48w x 30h x 18d cm | 18.9"w x 11.8"h x 7.1"d
- 0.78 kg | 1.72 lbs | 16 l | 976 cu in
- | Grey | Grau | 602818



71613329 049525



3Y WARRANTY

WindBridge

- 16" Laptop Business Case with Tablet Pocket
- Quick Pocket for easy access to essentials
- Essentials organizer
- Padded compartment for up to a 16" laptop
- 16" Laptop-Business Case mit Tablet-Fach
- Quick Pocket für leichten Zugang auf Ihre persönlichen Dinge
- Organizer für wichtige Accessoires
- Gepolstertes Fach für bis zu 16" Laptop
- 43w x 15h x 25d cm | 17.0"w x 6.0"h x 11.5"d
- 0.99 kg | 2.18 lbs | 18.8 l | 1147 cu in
- | Black | Schwarz | 602819



71613329 049532

PERSONALIZATION

THERMAL TRANSFER PRINT
THERMOTRANSFERDRUCK

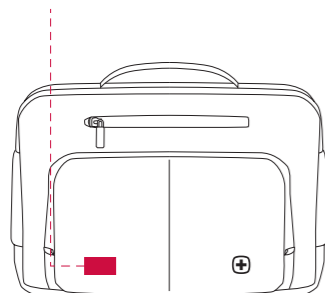

EMBROIDERY
STICKEREIEN

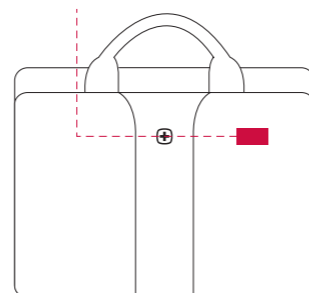

EMBROIDERY
STICKEREIEN

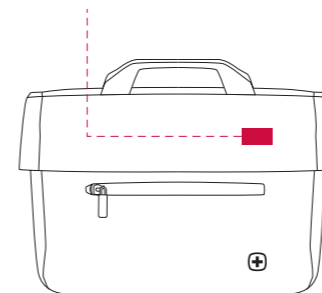

THERMAL TRANSFER PRINT
THERMOTRANSFERDRUCK

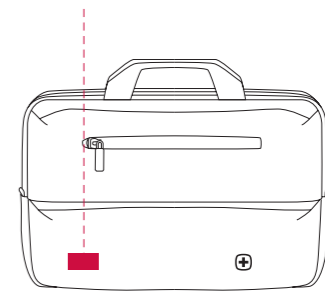



3Y
Warranty

16"
41 cm

12"
30 cm



Mandria

Convertible 16" Laptop Backpack/Business Case with Tablet Pocket

- Triple Protect padded compartment protects up to a 16" laptop
- Quick Pocket for easy access to essentials
- Essentials organizer with anti-scratch lining

Zweifach verwendbarer 16" Laptop-Rucksack und Business-Case mit Tablet-Fach

- Gepolstertes "Triple Protect"-Fach für bis zu 16" Laptop
- Quick Pocket für leichten Zugang auf Ihre persönlichen Gegenstände
- Organizer mit kratzsicherem Futter

32w x 42h x 23d cm | 12.6"w x 16.5"h x 9.1"d
1.06 kg | 2.33 lbs 22l | 1342 cu in

■ | Camel | Camel | 602833



PERSONALIZATION

INGOT
PLAKETTE

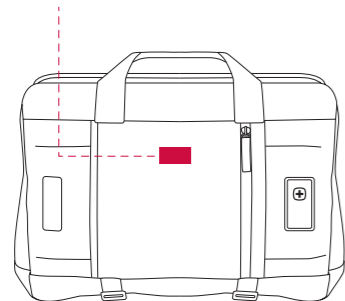

Tablet / E-Reader Cases



Affiliate

- Binder Padfolio with Tablet Pocket
- File divider with anti-scratch lining sized to hold a 10" tablet
 - Business organizer
 - Removable D-ring binder
 - Lined notepad

- Binder Padfolio mit Tablet-Fach
- Abtrennung mit Anti-Kratz-Futter für ein 10" Tablet
 - Business-Organizer
 - Abnehmbare Ringhefter
 - Liniertes Notizblock

26w x 35h x 5d cm | 10.2"w x 13.8"h x 2.0"d
0.91 kg | 2.01 lbs

- | Grey | Grau | 601360
- | Black | Schwarz | 601361



Venture

- Zippered Presentation Padfolio
- Removable D-ring Binder
 - Lined notepad
 - Business organizer

- Presentation Padfolio mit Reißverschluss
- Abnehmbare Ringhefter
 - Liniertes Notizblock
 - Business-Organizer

28w x 35h x 5d cm | 11"w x 13.8"h x 2"d
1.3 kg | 2.87 lbs

- | Black | Schwarz | 601673



PERSONALIZATION

THERMAL TRANSFER PRINT THERMOTRANSFERDRUCK

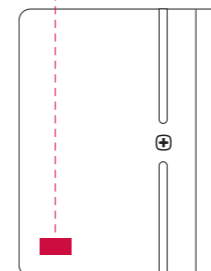

THERMAL TRANSFER PRINT THERMOTRANSFERDRUCK

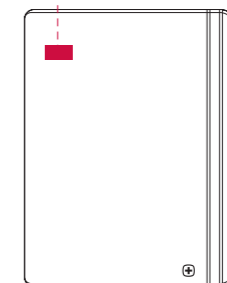



3Y
WARRANTY

14"
36 cm

10"
25 cm



Directive

- 14" Zippered Laptop Presentation Padfolio with Tablet Pocket
- Zippered compartment holds up to a 14" laptop
 - File divider with anti-scratch lining is sized to hold a tablet
 - Removable D-ring binder
 - Lined notepad

- 14" Laptop Presentation Padfolio mit Reißverschluss und Tablet-Fach
- Fach mit Reißverschluss für einen Laptop im Format bis zu 14"
 - Abtrennung mit Anti-Kratz-Futter für ein Tablet
 - Abnehmbarer Ringhefter
 - Linierter Notizblock

29w x 36h x 8d cm | 11.4"w x 14.2"h x 3.1"d
1.20 kg | 2.1 lbs

■ | Noir | Negro | 601598



71613329 039311



3Y
WARRANTY

13"
33 cm

10"
25 cm



Speedline

- 13" Vertical Laptop Slimcase
- Padded 13" laptop compartment and dedicated 10" tablet pocket with anti-scratch lining
 - Essentials organizer

- 13" Vertical Laptop Slimcase
- Gepolstertes Fach für einen 13" Laptop und separates 10" Tablet-Fach mit Anti-Kratz-Futter
 - Organizer für wichtige Accessoires

25w x 38h x 10d cm | 9.8"w x 15"h x 3.9"d
0.76 kg | 1.68 lbs 31 | 183 cu in

■ | Black | Schwarz | 601056



71613329 014318

PERSONALIZATION

THERMAL TRANSFER PRINT THERMOTRANSFERDRUCK

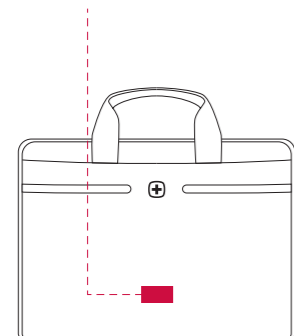

INGOT PLAKETTE

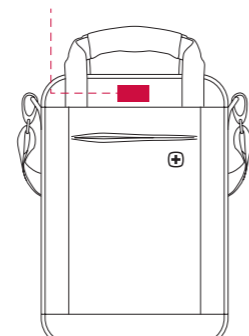

Sleeves



Legacy 10

- 10" iPad / Tablet / eReader Sleeve
- Lightweight slim design
 - Checkpoint-friendly
 - ShockGuard Protection System absorbs sudden impact

- 10 Zoll iPad / Tablet / eReader Hülle
- Leichtes, dünnes Design
 - Für Sicherheitskontrollen optimiert
 - ShockGuard System absorbiert eventuelle Schläge

30w x 23h x 2d cm | 12"w x 9"h x 0.75"d
0.2 kg | 0.5 lbs 2 l | 130 cu in

■ | Black | Schwarz | 600670



Legacy 14

- 14" Laptop Sleeve
- Fits up to most 14" laptops
 - ShockGuard system absorbs shocks from caused by impact
 - Checkpoint-friendly
 - Lightweight slim design

- 14 Zoll Laptop Hülle
- Laptop-Fach für einen Laptop im Format bis zu 14 Zoll
 - ShockGuard System absorbiert eventuelle Schläge
 - Für Sicherheitskontrollen optimiert
 - Leichtes, dünnes Design

36w x 29h x 2d cm | 14.25"w x 11.50"h x 0.75"d
0.32 kg | 0.71 lbs 3 l | 212 cu in

■ | Black | Schwarz | 600671



PERSONALIZATION

EMBROIDERY STICKEREIEN

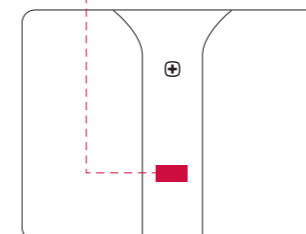

EMBROIDERY STICKEREIEN

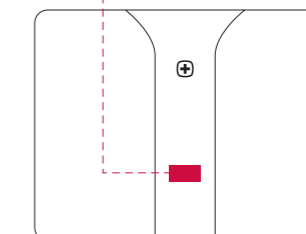



Legacy

- 15.6" Laptop Sleeve
- Fits up to most 15.6" laptops
 - ShockGuard system absorbs shocks from caused by impact
 - Checkpoint-friendly
 - Lightweight slim design

- 15.6" Laptop Hülle
- Laptop Fach für einen Laptop im Format bis zu 15.6"
 - ShockGuard System absorbiert eventuelle Schläge
 - Für Sicherheitskontrollen optimiert
 - Leichtes, dünnes Design

42w x 28h x 2d cm | 16.5"w x 11"h x 0.75"d
0.34 kg | 0.75 lbs 4 l | 235 cu in

■ | Black | Schwarz | 600672



71613329 1008300



Resolution 10

- 10" iPad Sleeve
- Padded anti-scratch protection for up to a 10" tablet
 - Hideaway carry handles

- 10" iPad Hülle
- Anti-Kratz-Futter für zuverlässigen Schutz für ein Tablet bis zu 10"
 - Verstaubare Tragegriffe

28w x 22h x 2d cm | 11"w x 8.7"h x 0.8"d
0.28 kg | 0.62 lbs 1 l | 61 cu in

■ | Black | Schwarz | 600673



71613329 1008317



Resolution 13

- 13" MacBook Sleeve
- Padded 13" MacBook Pro or MacBook Air compartment with anti-scratch lining
 - Hideaway carry handles

- 13" MacBook Hülle
- Gepolstertes Fach für ein 13" MacBook Pro oder ein MacBook Air mit Anti-Kratz-Futter
 - Verstaubare Tragegriffe

33w x 24h x 2d cm | 13"w x 9.4"h x 0.8"d
0.36 kg | 0.79 lbs 2 l | 122 cu in

■ | Black | Schwarz | 600674



71613329 1008324

PERSONALIZATION

EMBROIDERY STICKEREIEN

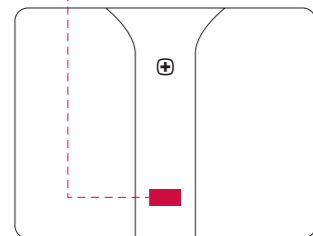

INGOT PLAKETTE

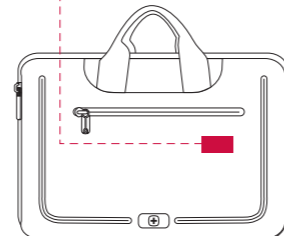

INGOT PLAKETTE

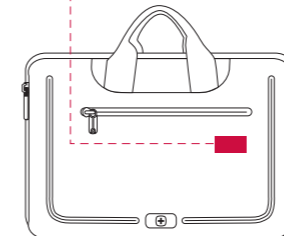

Slim Cases



Sherpa

- 16" Laptop Slimcase
- Padded compartment for up to a 16" laptop
- Quick Pocket for easy access to essentials
- Adjustable shoulder strap
- Pass-Thru trolley strap slides over the handle of wheeled luggage for easy travel with multiple bags

- 16" Laptop Slimcase
- Gepolstertes Fach für bis zu 16" Laptop
- Quick Pocket für leichten Zugriff auf Ihre persönlichen Dinge
- Verstellbarer Schultergurt
- Tragegurt zur Befestigung am Griff von Rollkoffern für komfortables Reisen mit mehreren Gepäckstücken

39w x 28h x 7d cm | 15.4"w x 11"h x 2.8"d
0.5 kg | 1.1 lbs 8 l | 466 cu in

Black | Schwarz | 600653



7|613329 |008119



Legacy

- 16" Laptop Briefcase
- Checkpoint-friendly protection for up to a 16" laptop
- Zip-down opening for the on-the go access
- Essentials organizer

- 16" Laptop-Aktentasche
- Praktisch an Kontrollpunkten, zuverlässiger Schutz für einen Laptop bis zu 16"
- Reissverschluss für schnellen Zugriff
- Organizer für wichtige Accessoires

41w x 30h x 14d cm | 16.1"w x 11.8"h x 5.5"d
1.31 kg | 2.89 lbs 11 l | 671 cu in

Black | Schwarz | 600647



7|613329 |008058

PERSONALIZATION

INGOT PLAKETTE

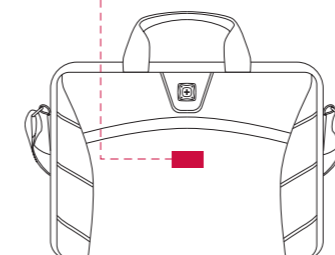

EMBROIDERY STICKEREIEN

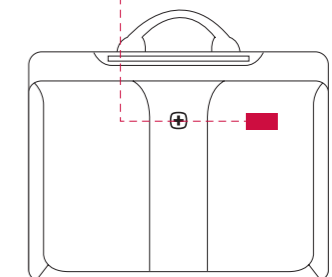



3Y

10" 26 cm

14" 36 cm



Format 14

- 14" Laptop Slimcase with Tablet Pocket
- Padded compartment with anti-scratch lining for up to a 14" laptop
 - Essentials organizer features a 10" tablet pocket with anti-scratch lining
 - File divider with two mesh interior accessories pockets

- 14" Laptop Slimcase mit Tablet-Fach
- Gepolstertes Fach mit Anti-Kratz-Futter für ein Laptop bis zu 14"
 - Organizer mit 10" Tablet-Fach mit Anti-Kratz-Futter
 - Abtrennung mit zwei Netz-Zubehörtaschen innen

39w x 26h x 8d cm | 15.4"w x 10.2"h x 3.1"d
 0.78 kg | 1.72 lbs 5 l | 305 cu in

■ | Black | Schwarz | 601079
 ■ | Grey | Grau | 601080



PERSONALIZATION

INGOT PLAKETTE

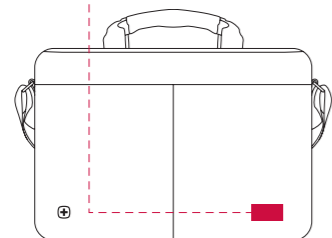

Wheeled Cases



WENGER
wenger.ch

WENGER



3Y



17"



Granada

- 17" Wheeled Laptop Case
- Padded compartment for up to a 17" laptop
- Secure lock handle and easy-glide wheels
- Overnight compartment
- Essentials organizer and file divider

- 17" Laptop-Tasche mit Rollen
- Gepolstertes Fach für bis zu 17" Laptop
- Arretierbarer Griff und Leichtlaufrollen
- Overnight-Fach
- Essentials Organizer und Abtrennung

42w x 35h x 25d cm | 16.5"w x 13.8"h x 9.8"d
3.88 kg | 8.55 lbs 24 l | 1465 cu in

■ | Black | Schwarz | 600659



7 613329 1 008171



3Y



17"



15.4"



Potomac

- 2-Piece Business Set with Comp-U-Roller and Matching 15.4" Laptop Case
- Comp-U-Roller contains a padded compartment that protects up to a 15.4" laptop
- Overnight clothing storage compartment
- Expanding files folders and essentials organizer
- Comes with matching 15.4" laptop case

- 2-teiliges Business Set mit Comp-U-Roller und passender 15,4" Laptop-Tasche
- Der Comp-U-Roller bietet ein gepolstertes Fach für den zuverlässigen Schutz eines Laptops bis zu 15,4"
- Overnight-Kleiderfach
- Erweiterbare Aktenfächer und Organizer
- Mit passender 15,4" Laptop-Tasche

44w x 42h x 25d cm | 17.3"w x 16.5"h x 9.8"d
3.46 kg | 7.63 lbs 23 l | 1404 cu in

■ | Black | Schwarz | 600661



7 613329 1 008195

PERSONALIZATION

EMBROIDERY STICKEREIEN

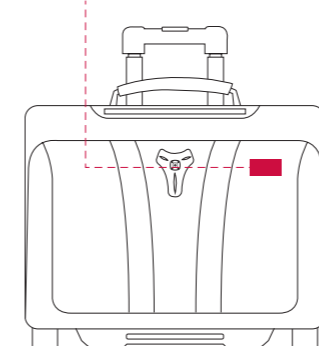

INGOT PLAKETTE

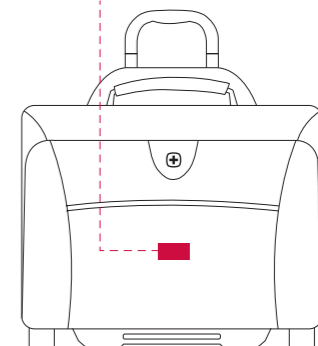



3Y



17"

43 cm

15.4"

39 cm



2



Patriot

- 2-Piece Business Set with Comp-U-Roller and Matching 15.4" Laptop Case
- Comp-U-Roller contains a padded compartment that protects up to a 17" laptop
 - Overnight clothing storage compartment
 - Expanding files folders and essentials organizer
 - Comes with matching 15.4" laptop case

- 2-teiliges Business Set mit Comp-U-Roller und passender 15,4" Laptop-Tasche
- Der Comp-U-Roller bietet ein gepolstertes Fach für den zuverlässigen Schutz eines Laptops bis zu 17"
 - Overnight-Kleiderfach
 - Erweiterbare Aktenfächer und Organizer
 - Mit passender 15,4" Laptop-Tasche

43w x 41h x 31d cm | 16.9"w x 16.1"h x 12.2"d
4.06 kg | 8.95 lbs 25 l | 1526 cu in

■ | Black | Schwarz | 600662



PERSONALIZATION

EMBROIDERY STICKEREIEN

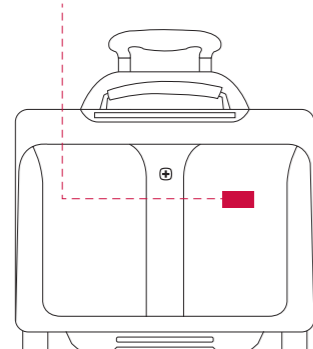

Woman's Cases



WENGER
wenger.ch

WENGER



Eva 13

13" Women's Expandable Tote with Removable Laptop Sleeve

- Removable padded sleeve protects up to a 13" laptop and a 10" tablet
- Feet protect the bottom of the bag
- Zippered accessory pocket
- Expandable main compartment

13" erweiterbare Damen Tasche mit herausnehmbarer Laptophülle

- Herausnehmbare Hülle für einen Laptop im Format bis zu 13" und ein 10" Tablet
- Standfüsse schützen den Taschenboden
- Zusatzfach mit Reißverschluss
- Erweiterbares Hauptfach

41w x 30h x 11d cm | 16.1" w x 11.8" h x 4.3" d
0.8 kg | 1.76 lbs 10 l | 610 cu in

■ | Black | Schwarz | 601077



Ana

15.6" Women's Laptop Tote with Tablet Pocket

- Padded 15.6" laptop compartment and dedicated 10" tablet pocket
- Interior zippered pocket
- Feet protect the bottom of the bag
- Removable adjustable shoulder strap
- Rear pocket unzips to become a Pass-Thru trolley sleeve for easy travel wheeled luggage

15.6" Damen Laptoptasche mit Fach für ein Tablet

- Gepolstertes Notebook-Fach zum Schutz eines Laptops im Format bis zu 15.6" und zusätzliches Fach für ein 10" Tablet
- Inneres Fach mit Reißverschluss
- Standfüsse schützen den Taschenboden
- Abnehmbare Schulterriemen
- Trolleyaufstecksystem zum komfortablen Reisen mit Gepäck auf Rollen

42w x 35h x 19d cm | 16.5" w x 13.8" h x 7.5" d
0.99 kg | 2.18 lbs 16 l | 976 cu in

■ | Black | Schwarz | 601375



PERSONALIZATION

INGOT PLAKETTE

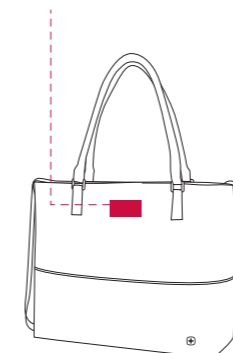

INGOT PLAKETTE





3Y

10" 25 cm

16" 41 cm



Alexa 16

- 16" Women's Laptop Backpack with Tablet Pocket
- Padded 16" laptop compartment and dedicated tablet pocket
- Essentials organizer with anti-scratch lining
- Pass-Thru trolley sleeve slides over the handle of wheeled luggage for easy travel with multiple bags

- 16" Damen-Laptop-Rucksack mit Tablet-Fach
- Gepolstertes Fach für 16" Laptop und separates Tablet-Fach
- Organizer mit kratzsicherem Futter
- Trageschleife zur Befestigung am Griff von Rollengepäck für komfortables Reisen mit mehreren Gepäckstücken

33w x 43h x 14d cm | 13"w x 16.9"h x 5.5"d
0.78 kg | 1.72 lbs 12 l | 732 cu in

■ | Black | Schwarz | 601376



71613329 1035559

PERSONALIZATION

INGOT
PLAKETTE

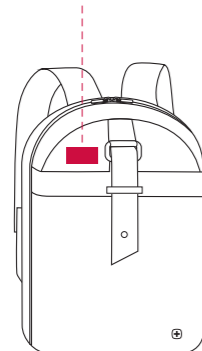

EMBROIDERY

Embroidery is our preferred method of personalization. Using specific color threads and stitches your logo can be re-created perfectly. It produces a high-quality finish which is durable and stands the test of time.

- For color matching please specify a pantone reference or thread brand and color number.
- Digitized files created for items such as t-shirts and caps may not be suitable for use on our products. We can check and advise if needed.
- Please be aware that we can only guarantee the quality of embroidery on disks originated by us.

STICKEREIEN

Zur Personalisierung verwenden wir bevorzugt Stickereien. Unter Einsatz speziell gefärbter Garne und bestimmter Sticktechniken lässt sich Ihr Logo perfekt nachbilden. Sie erhalten ein hochwertig verarbeitetes Emblem, das sich durch Widerstandsfähigkeit und eine lange Lebensdauer auszeichnet.

- Bitte geben Sie zum Farbabgleich eine Pantone-Referenznummer oder die Garnmarke mit Farbnummer an.
- Digitalisierte Dateien, die für Artikel wie T-Shirts und Kappen erstellt wurden, sind für unsere Produkte unter Umständen nicht geeignet. Wir können sie prüfen und Sie gegebenenfalls beraten.
- Bitte beachten Sie, dass wir die Qualität der Stickereien nur auf von uns stammenden Disks garantieren können.

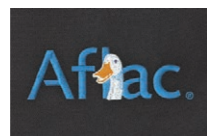

Two examples of embroidered company logos

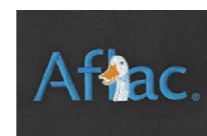

Zwei Beispiele für aufgestickte Firmenlogos

LASER ENGRAVED INGOTS

Laser engraving is available on our elegant and stylish ingot plates. These plates can be placed on the majority of items. Attachment of the ingot will be in a specific pre-determined area. Ingot are available in the following finishes and sizes.



Rectangle Black Finish 5 x 3 cm



Rectangle Brushed Silver Finish 5 x 3 cm



Rechteckige Ausführung in Schwarz 5 x 3 cm



Rechteckige Ausführung in Silber gebürstet 5 x 3 cm



Square Black Finish 3 x 3 cm



Square Brushed Silver Finish 3 x 3 cm



Quadratische Ausführung in Schwarz 3 x 3 cm



Quadratische Ausführung in Silber gebürstet 3 x 3 cm

DIGITAL PRINT - INGOTS

Digital print is available on our elegant and stylish ingot plates. The ingots can be placed on the majority of items. Attachment of the ingot will be in a specific pre-determined area. Ingot are available in the following finishes and sizes.



DIGITALDRUCK – PLAKETTEN

Bei unseren eleganten, stilvollen Plaketten ist ein Digitaldruck möglich. Die Plaketten können auf den meisten unserer Produkte an bestimmten Stellen angebracht werden. Sie sind in den folgenden Formen und Grössen erhältlich.

THERMAL TRANSFER PRINT

Thermal Transfer Print is available on selected lifestyle accessories and backpacks. Realise your company Logo with a high quality thermal transfer print.



THERMOTRANSFERDRUCK

Thermotransferdruck ist bei bestimmten Lifestyle-Accessoires und Rucksäcken verfügbar. Verewigen Sie Ihr Firmenlogo mit einem hochwertigen Thermotransferdruck.



GENERAL INFORMATION

Artwork

For all decorating processes we require clean crisp, high resolution artwork. Vector artwork is required with all fonts converted to outlines. Acceptable file types include AI and EPS.

- For all personalisation processes the text should be no smaller than 5 mm.

Lead time

- 30 days from artwork approval.
- For orders over 250 units please contact your B2B representative for a delivery schedule.
- Order minimum is 10 units.

Warranty

- Please note that all forms of personalization will not be covered under the product warranty.

The company logos printed herein are shown for demonstration purposes only and remain property of the respective company.

ALLGEMEINE INFORMATIONEN

Grafik

Für alle grafischen Elemente benötigen wir saubere Grafiken in hoher Auflösung. Hierzu benötigen wir Vektorgrafiken, wobei die Fonts in Outline-Grafiken konvertiert sein müssen. Kompatible Dateiformate sind auch AI und EPS.

- Für alle Personalisierungen sollte der Text nicht kleiner als 5 mm sein.

Vorlaufzeit

- 30 Tage ab Bestätigung der Grafiken.
- Bei Bestellungen über 250 Einheiten, setzen Sie sich bitte mit unserem B2B-Repräsentanten in Verbindung, um einen Liefertermin zu vereinbaren.
- Mindestbestellmenge: 10 Einheiten

Garantie

- Bitte beachten Sie, dass alle personalisierten Produkte von der Produkthaftung ausgeschlossen sind.

Die abgebildeten Firmen-Logos / Schriftzüge dienen lediglich zur Veranschaulichung und sind Eigentum der entsprechenden Unternehmungen.

WENGER TRAVEL GEAR ICON OVERVIEW

- | | |
|--|--|
|  3 year warranty
3 Jahre Garantie |  Shock absorbing shoulder strap
Elastischer, Schlag absorbierender Schultergurt |
|  Side pocket
Seitenfach |  Adjustable sternum strap
Verstellbarer Brustgurt |
|  Quick pocket
Schnell-Zugriffsfach für Schlüssel, Smartphone, Brille... |  Adjustable waist strap
Verstellbarer Hüftgurt |
|  Padded 7" tablet compartment
7" Tablet-Fach |  Compression strap
Kompressionsriemen |
|  Padded 10" tablet compartment
10" Tablet-Fach |  Reflective accents for better visibility at night
Reflektoreinsätze für erhöhte Sichtbarkeit im Dunkeln |
|  Padded 11" tablet compartment
11" Tablet-Fach |  Elastic front cord
Elastische Frontkordel |
|  Padded 12" tablet compartment
12" Tablet-Fach |  Telescopic handle
Teleskop Handgriff |
|  Padded 12.9" tablet compartment
12.9" Tablet-Fach |  Pass-Thru trolley sleeve – briefcase
Halterung zur Befestigung der Laptop-Tasche auf dem Koffer |
|  Padded 10" laptop compartment
10" Laptop-Fach gepolstert |  Pass-Thru trolley sleeve – backpack
Halterung zur Befestigung des Rucksacks auf dem Koffer |
|  Padded 13" laptop compartment
13" Laptop-Fach gepolstert |  2 wheels
2 Rollen |
|  Padded 14" laptop compartment
14" Laptop-Fach gepolstert |  4 wheels/spinner
4 Rollen/Spinner |
|  Padded 15" laptop compartment
15" Laptop-Fach gepolstert |  Lockable zipper
Abschliessbarer Reissverschluss |
|  Padded 15.4" laptop compartment
15.4" Laptop-Fach gepolstert |  Folio with zipper
Mappe mit abschliessbarem Reissverschluss |
|  Padded 15.6" laptop compartment
15.6" Laptop-Fach gepolstert |  Water repellant fabric
Wasserresistentes Material |
|  Padded 16" laptop compartment
16" Laptop-Fach gepolstert |  Removable shoulder strap
Abnehmbarer Schulterriemen |
|  Padded 17" laptop compartment
17" Laptop-Fach gepolstert |  Expandable
Erweiterbar |
|  Padded 17.3" laptop compartment
17.3" Laptop-Fach gepolstert |  Overnight clothing storage compartment
Overnight-Kleiderfach |
|  Triple Protect Laptop protection
Triple Protect System für Laptop-Sicherung |  Anti-scratch lining
Kratzsicheres Innenfutter |
|  Checkpoint friendly
Vereinfachte Sicherheitskontrolle |  Pro Vent (air circulation system)
Pro Vent (Umluftsystem) |
|  Casebase
Klappbarer Boden zur Stabilisierung |  Separate shoe compartment
Separates Schuhfach |
|  Essentials Organizer
Organizer für wichtige Accessoires | |
|  AIR FLOW
Air-flow back panel
Atmungsaktives Rückenteil | |





Victorinox Travel Gear AG
Schmiedgasse 57
CH-6438 Ibach-Schwyz, Switzerland

+41 41 818 16 64
b2b.travelgear@victorinox.com
wenger.ch