



# OpenScape Business V2

## Administrator Documentation

A31003-P3020-M100-16-76A9

Provide feedback to further optimize this document to [edoku@unify.com](mailto:edoku@unify.com).

As reseller please address further presales related questions to the responsible presales organization at Unify or at your distributor. For specific technical inquiries you may use the support knowledgebase, raise - if a software support contract is in place - a ticket via our partner portal or contact your distributor.

Our Quality and Environmental Management Systems are implemented according to the requirements of the ISO9001 and ISO14001 standards and are certified by an external certification company.

Copyright © Unify Software and Solutions GmbH & Co. KG 10/2017  
Mies-van-der-Rohe-Str. 6, 80807 Munich/Germany

All rights reserved.

Reference No.: A31003-P3020-M100-16-76A9

The information provided in this document contains merely general descriptions or characteristics of performance which in case of actual use do not always apply as described or which may change as a result of further development of the products. An obligation to provide the respective characteristics shall only exist if expressly agreed in the terms of contract.

Availability and technical specifications are subject to change without notice.

Unify, OpenScape, OpenStage, Circuit and HiPath are registered trademarks of Unify Software and Solutions GmbH & Co. KG. All other company, brand, product and service names are trademarks or registered trademarks of their respective holders.

# Contents

<b>1 Introduction and Important Notes</b>	<b>39</b>
1.1 About this Documentation	39
1.1.1 Documentation and Target Groups	40
1.1.2 Structure of the Administrator Documentation	41
1.1.3 Types of Topics	43
1.1.4 Display Conventions	44
1.2 Safety Information and Warnings	44
1.2.1 Warnings: Danger	45
1.2.2 Warnings: Warning	46
1.2.3 Warnings: Caution	47
1.2.4 Warnings: Note	48
1.2.5 Country-specific Safety Information	49
1.2.5.1 Safety Information for Australia	49
1.2.5.2 Safety Information for Brazil	50
1.2.5.3 Safety Information for the U.S.	50
1.2.5.4 Safety Information for Canada	52
1.3 Important Notes	53
1.3.1 Emergencies	53
1.3.2 Proper Use	54
1.3.3 Correct Disposal and Recycling	54
1.3.4 Installation Standards and Guidelines	55
1.3.4.1 Connecting OpenScape Office X to the Power Supply Circuit	55
1.3.4.2 Connecting OpenScape Business S and OpenScape Business UC Booster Server to the Power Supply Circuit	56
1.3.4.3 Shielded Cabling for LAN and WAN Connections of OpenScape Business X	56
1.3.4.4 Fire Safety Requirements	57
1.3.4.5 Lightning Protection Requirements	57
1.3.4.6 Markings for OpenScape Business X	58
1.3.5 Notes on Electromagnetic and Radio Frequency Interference of OpenScape Business X	58
1.3.6 Data Protection and Data Security	58
1.3.7 Technical Regulations and Conformity of OpenScape Business X	59
1.3.7.1 CE Conformity	59
1.3.7.2 Conformity with US and Canadian Standards	60
1.3.7.3 Conformity with International Standards	60
1.3.8 Operating Conditions	60
1.3.8.1 Operating Conditions for OpenScape Business X	60
1.3.8.2 Operating Conditions for OpenScape Business S and OpenScape Business UC Booster Server	61
<b>2 System Overview</b>	<b>62</b>
2.1 Highlights	62
2.2 Unified Communications	63
2.2.1 UC Features (Overview)	63
2.2.2 User Access to UC Features (UC Clients)	69
2.2.3 Integration in Business Applications	73
2.3 OpenScape Business Models	73
2.3.1 Expansion Levels Available through Sales	74
2.3.2 UC Hardware Models	77

## Contents

2.3.3 UC Booster Hardware	78
2.3.4 UC Software Models (Softswitch)	79
2.3.5 Structure and Environmental Conditions	79
2.3.6 Supported Phones	79
2.4 Further information	80
2.4.1 Languages Supported	81
2.4.2 Internet Links	83
<b>3 Administration Concept</b>	<b>84</b>
3.1 OpenScape Business Assistant (WBM)	84
3.1.1 Requirements for the WBM	84
3.1.2 Home Page of the WBM	84
3.1.3 Introduction to the WBM	86
3.1.3.1 How to Log into the WBM	88
3.1.3.2 How to Log out from the WBM	88
3.1.4 WBM User Management	89
3.1.4.1 How to Add an Administrator	92
3.1.4.2 How to Edit an Administrator	92
3.1.4.3 How to Change your Own Administrator Password	92
3.1.4.4 How to Delete an Administrator	93
3.1.4.5 How to change a Manager E Administrator password	93
3.1.5 Wizards	94
3.1.5.1 Wizards – Basic Installation	94
3.1.5.2 Wizards – Network / Internet	94
3.1.5.3 Wizards – Telephones / Subscribers	95
3.1.5.4 Wizards – Central Telephony	95
3.1.5.5 Wizards – User Telephony	96
3.1.5.6 Wizards – Security	96
3.1.5.7 Wizards - UC Smart (only with UC Smart)	97
3.1.5.8 Wizards - UC Suite (only with UC Suite)	97
3.1.5.9 Wizards – Circuit	98
3.1.5.10 Wizards – Unified Directory	98
3.1.6 Service Center	98
3.1.6.1 Service Center – <b>Documents</b>	98
3.1.6.2 Service Center – <b>Software</b>	99
3.1.6.3 Service Center – <b>Inventory</b>	99
3.1.6.4 Service Center – <b>Software Update</b>	99
3.1.6.5 Service Center – <b>E-mail Forwarding</b>	99
3.1.6.6 Service Center – <b>Remote Access</b>	100
3.1.6.7 Service Center – <b>Restart / Reload</b>	100
3.1.6.8 Service Center – <b>Diagnostics &gt; Status</b>	100
3.1.6.9 Service Center – <b>Diagnostics &gt; Event Viewer</b>	100
3.1.6.10 Service Center – <b>Diagnostics &gt; Trace</b>	100
3.1.6.11 Service Center – <b>Diagnostics &gt; Service log</b>	100
3.1.7 Expert Mode	100
3.1.8 Online Help	101
3.1.8.1 How to Invoke the Context-Sensitive Online Help	101
3.2 Manager E	101
3.2.1 How to Load the CDB into Manager E	102
3.2.2 How to Load the CDB Back into the System	103
<b>4 Initial Setup for OpenScape Business X</b>	<b>104</b>
4.1 Prerequisites for the Initial installation	104

4.2	Components	105
4.3	Dial Plan	107
4.4	IP Address Scheme	107
4.5	Initial Startup	109
4.5.1	How to Restart the Communication System	110
4.5.2	How to Connect the Admin PC to the Communication System	110
4.5.3	How to Start the WBM	111
4.6	Integration into the Customer LAN	113
4.6.1	How to Start the Initial Installation Wizard	113
4.6.2	System Settings	114
4.6.2.1	How to Set the Display Logo and the Product Name	114
4.6.2.2	How to Specify the IP Addresses (Optional)	115
4.6.2.3	How to Specify the Device Name	116
4.6.3	DHCP Settings	117
4.6.3.1	How to Disable the Internal DHCP Server	118
4.6.3.2	How to Enable and Configure the Internal DHCP Server	118
4.6.4	Country and Time Settings	120
4.6.4.1	How to Select the Country Code and the Language for Event Logs	120
4.6.4.2	How to Enter the DECT System ID	121
4.6.4.3	How to Set the Date and Time Manually	122
4.6.4.4	How to Obtain the Date and Time from an SNTP Server	122
4.6.5	UC Solution	123
4.6.5.1	How to Define the UC Solution	124
4.6.6	Connecting the Communication System to the Customer LAN	125
4.6.6.1	How to Connect the Communication System to the Customer LAN	125
4.7	Basic Configuration	125
4.7.1	How to Start the Basic Installation Wizard	126
4.7.2	System Phone Numbers and Networking	126
4.7.2.1	How to Enter the System Phone Numbers for a Point-to-Point connection	127
4.7.2.2	How to Enter the System Phone Numbers for a Point-to-Multipoint Connection	128
4.7.2.3	How to Activate or Deactivate Networking	129
4.7.3	Station Data	129
4.7.3.1	How to Display the Station Data	131
4.7.3.2	How to Delete all Call Numbers	131
4.7.3.3	How to Adapt Preconfigured Station Numbers for the Individual Dial Plan	132
4.7.3.4	How to Import the Station Data from an XML File	132
4.7.3.5	How to display Mass data	133
4.7.4	ISDN Configuration	134
4.7.4.1	How to Configure the Connection of ISDN Stations	134
4.7.4.2	How to Configure the ISDN Point-to-Point Connection	135
4.7.4.3	How to Configure the ISDN Point-to-Multipoint Connection	135
4.7.4.4	How to Deactivate the ISDN Configuration	136
4.7.5	Internet Access	136
4.7.5.1	How to Configure Internet Access via an External Internet Router over the LAN Port	138
4.7.5.2	How to Configure Internet Access via an External Internet Router over the WAN Port	138
4.7.5.3	How to Configure Internet Access via a Preconfigured ISP	140
4.7.5.4	How to Configure Internet Access via the Standard ISP PPPoE	141
4.7.5.5	How to Configure Internet Access via a Standard ISP PPTP	144
4.7.5.6	How to Disable Internet Access	147
4.7.6	Internet Telephony	147
4.7.6.1	How to Configure a Predefined ITSP	148
4.7.6.2	How to Deactivate Internet Telephony	155

## Contents

4.7.7 Stations	155
4.7.7.1 How to Configure ISDN Stations	156
4.7.7.2 How to Configure Analog Stations	158
4.7.7.3 How to Configure UP0 Stations	161
4.7.7.4 How to Configure DECT Stations	163
4.7.7.5 How to Configure IP and SIP Stations	166
4.7.8 Configuring UC Suite	168
4.7.8.1 How to Configure the UC Suite	169
4.7.9 Configuring UC Smart Mailboxes	169
4.7.9.1 How to Configure UC Smart Voicemail Boxes	169
4.7.10 Conference Server Settings	170
4.7.10.1 How to Edit the Conference Server Settings	170
4.7.11 E-mail Delivery (Optional)	171
4.7.11.1 How to Configure the Sending of E-mails	171
4.8 Closing Activities	172
4.8.1 How to Activate and Assign the Licenses	173
4.8.2 How to Provision the UC Smart Client for Installation	175
4.8.3 How to Provision the UC Suite Clients for Installation	176
4.8.4 How to Perform a Data Backup	177
4.9 Commissioning of IP Phones	178
4.9.1 How to Configure an IP Phone	179
4.9.2 How to Configure a SIP Phone	181
<b>5 Initial Setup for OpenScape Business S</b>	<b>183</b>
5.1 Prerequisites for the Initial Setup	183
5.2 Components	185
5.3 IP Address Scheme	186
5.4 Dial Plan	187
5.5 Installing the Communication Software	188
5.5.1 How to Install the Communication Software	190
5.6 Function Check with the OpenScape Observer	192
5.6.1 How to Copy OpenScape Observer to the PC	192
5.6.2 How to Start OpenScape Observer from the PC	194
5.7 Starting Up	194
5.7.1 How to Start the Initial Installation Wizard	194
5.7.2 System Settings	195
5.7.2.1 How to Set the Display Logo and the Product Name	195
5.7.2.2 How to Select the Country Code and the Language for Event Logs	196
5.7.2.3 How to Activate an Additional LAN Port as a WAN Interface	197
5.7.3 UC Solution	197
5.7.3.1 How to Define the UC Solution	198
5.8 Basic Configuration	198
5.8.1 How to Start the Basic Installation Wizard	199
5.8.2 System Phone Numbers and Networking	199
5.8.2.1 How to Enter the System Phone Numbers for a Point-to-Point connection	200
5.8.2.2 How to Enter the System Phone Numbers for a Point-to-Multipoint Connection	200
5.8.2.3 How to Activate or Deactivate Networking	201
5.8.2.4 How to Configure the Upstream of your Internet connection	202
5.8.3 Station Data	202
5.8.3.1 How to Display the Station Data	203
5.8.3.2 How to Delete all Call Numbers	204
5.8.3.3 How to Adapt Preconfigured Station Numbers for the Individual Dial Plan	204

5.8.3.4	How to Import the Station Data from an XML File	205
5.8.4	Internet Telephony	205
5.8.4.1	How to Configure a Predefined ITSP	207
5.8.4.2	How to Deactivate Internet Telephony	213
5.8.5	Stations	213
5.8.5.1	How to Configure IP and SIP Stations	214
5.8.6	Configuring UC Suite	216
5.8.6.1	How to Configure the UC Suite	217
5.8.7	Configuring UC Smart Mailboxes	217
5.8.7.1	How to Configure UC Smart Voicemail Boxes	217
5.8.8	Conference Server Settings	218
5.8.8.1	How to Edit the Conference Server Settings	218
5.8.9	E-mail Delivery (Optional)	219
5.8.9.1	How to Configure the Sending of E-mails	219
5.9	Closing Activities	220
5.9.1	How to Activate and Assign the Licenses	221
5.9.2	How to Provision the UC Smart Client for Installation	223
5.9.3	How to Provision the UC Suite Clients for Installation	224
5.9.4	How to Perform a Data Backup	225
5.10	Commissioning of IP Phones	225
5.10.1	How to Configure an IP Phone	227
5.10.2	How to Configure a SIP Phone	228
5.11	Uninstalling the Communication Software	230
5.11.1	How to Uninstall the Communication Software	230
5.12	Used Ports	230
<b>6</b>	<b>Initial Setup of OpenScape Business UC Booster</b>	<b>233</b>
6.1	Prerequisites for the Initial Setup	235
6.2	Backing up the Configuration Data of the Communication System	238
6.2.1	How to Perform a Data Backup	238
6.3	Commissioning the UC Booster Card	239
6.3.1	Installing the UC Booster Card	239
6.3.2	Configuring the UC Booster Card	239
6.3.3	Updating the Software for the UC Booster Card	240
6.3.3.1	How to Perform a Software Update	240
6.4	Commissioning the UC Booster Server	241
6.4.1	Installing the Communication Software	241
6.4.1.1	How to Install the Communication Software	242
6.4.2	Function Check with the OpenScape Observer	244
6.4.2.1	How to Copy OpenScape Observer to the PC	244
6.4.2.2	How to Start OpenScape Observer from the PC	246
6.4.3	Configuring the UC Booster Server	247
6.4.3.1	Announcing the IP Address of the Communication System	247
6.4.4	Updating the Software for the UC Booster Card	249
6.5	Basic Configuration	249
6.6	Closing Activities	250
6.7	Uninstalling the Communication Software	251
6.7.1	How to Uninstall the Communication Software	251
6.8	Upgrading from the UC Booster Card to the UC Booster Server	251
6.9	Used Ports	253
<b>7</b>	<b>Licensing</b>	<b>255</b>
7.1	Licensing Procedure	256

## Contents

7.2 Licenses	258
7.2.1 Basic License	259
7.2.2 Station Licenses	260
7.2.3 User-oriented Licenses	261
7.2.4 System Licenses	263
7.2.5 Evaluation Licenses	265
7.2.6 Upgrade Licenses	267
7.2.7 Possible License Combinations	268
7.3 Licensing a Communication System (Standalone)	270
7.3.1 Activating Licenses (Standalone)	270
7.3.1.1 How to Activate Licenses Online (Standalone)	271
7.3.1.2 How to Activate Licenses Offline (Standalone)	272
7.3.2 Assigning Licenses (Standalone)	273
7.3.2.1 How to License Subscribers (Standalone)	276
7.3.2.2 How to License Trunks (Standalone)	278
7.4 Licensing Multiple Communication Systems (Internetwork)	278
7.4.1 License Activation (Internetwork)	280
7.4.1.1 How to Activate Licenses Offline (Internetwork)	281
7.4.1.2 How to Combine License Files into a Network License File	282
7.4.2 Assigning Licenses (Internetwork)	283
7.4.2.1 How to License Subscribers (Internetwork)	286
7.4.2.2 How to License Trunks (Internetwork)	288
7.4.2.3 How to Assign System Licenses to a Node	289
7.4.2.4 How to Assign the "Networking" System License to a Node	289
7.5 License information	290
7.5.1 License Information without a Network (Standalone)	290
7.5.1.1 How to Display License Information	290
7.5.2 License Information in an Internetwork	291
7.5.2.1 How to Display all Licenses in the Internetwork	291
7.5.2.2 How to Display the Licenses Bound to a Node	292
7.5.2.3 How to Display all Shared Licenses in an Internetwork	292
7.5.2.4 How to Display a Node-Dependent View of Station Licenses and User-Oriented Licenses	293
7.6 Assigning License Profiles	293
7.6.1 How to Add a License Profile	294
7.6.2 How to Edit a License Profile	295
7.6.3 How to Assign a License Profile to Stations	296
7.6.4 How to Delete a License Profile	297
7.7 Rehosting after Replacement of Hardware	298
7.7.1 How to Perform a Rehost after Replacing Hardware	299
7.8 License Server (Central License Server, CLS)	299
7.8.1 How to Check or Change the IP Address of the License Server	300
7.9 Customer License Agent (CLA)	300
7.9.1 How to Configure the Connection to the Local License Agent	301
7.9.2 How to Change the Connection to the Central License Agent	301
7.10 Locking ID and Advanced ID Locking	301
7.10.1 How to Check the Locking ID of the Communication System	302
7.10.2 How to Check the Locking ID of the Softswitch	303
7.10.3 How to Check the Advanced Locking ID of Softswitches	303
<b>8 Integration into the Internal Data Network (LAN)</b>	<b>304</b>
8.1 LAN Interface	304
8.1.1 IP Address and Subnet Mask of the LAN Interface	304



8.1.1.1	How to Change the IP Address and Subnet Mask of the Hardware Platform . . . . .	305
8.1.1.2	How to Change the IP Address of the UC Booster Card . . . . .	306
8.1.1.3	How to Check or Change the IP Address and Subnet Mask of the Softswitch . . . . .	306
8.1.2	Internal IP Address Range of the LAN Interface. . . . .	307
8.1.2.1	How to Change the Internal IP Address Range of the Hardware Platform . . . . .	307
8.1.2.2	How to Reset the Internal IP Address Range of the Hardware Platform. . . . .	308
8.2	DHCP . . . . .	308
8.2.1	DHCP Relay Agent . . . . .	309
8.2.1.1	How to Configure the Hardware Platform as a DHCP Relay Agent . . . . .	309
8.2.2	DHCP Server . . . . .	310
8.2.2.1	How to Enable and Configure the DHCP Server of the Hardware Platform . . . . .	311
8.2.2.2	How to Disable the DHCP Server of the Hardware Platform . . . . .	313
8.2.2.3	How to Enable and Configure the DHCP Server of the Softswitch . . . . .	313
8.2.2.4	How to Disable the DHCP Server of the Softswitch . . . . .	314
8.3	DNS - Name Resolution . . . . .	314
8.3.1	How to Define an External DNS Server . . . . .	316
8.4	IP Routing . . . . .	317
8.4.1	How to Activate or Deactivate the Default Router . . . . .	317
8.4.2	How to Add a Static Route . . . . .	318
8.4.3	How to Delete Static Routes. . . . .	319
8.5	Deployment Service (DLS and DLI). . . . .	319
8.5.1	How to Configure the External DLS Server in the Internal DHCP Server. . . . .	321
8.5.2	How to Enable the Internal DLI. . . . .	322
8.5.3	How to Configure the Communication System as a Deployment and Licensing Client . . . . .	323
<b>9</b>	<b>Connection to Service Provider . . . . .</b>	<b>325</b>
9.1	Internet Access . . . . .	325
9.1.1	Internet Access via an External Internet Router . . . . .	327
9.1.1.1	How to Configure Internet Access via an External Internet Router over the LAN Port . . . . .	327
9.1.1.2	How to Configure Internet Access via an External Internet Router over the WAN Port . . . . .	328
9.1.2	Internet Access via an Internet Modem . . . . .	330
9.1.2.1	How to Configure Internet Access via a Preconfigured ISP . . . . .	331
9.1.2.2	How to Configure Internet Access via a Standard ISP PPPoE . . . . .	333
9.1.2.3	How to Configure Internet Access via a Standard ISP PPTP . . . . .	335
9.1.3	WAN port . . . . .	338
9.1.4	DynDNS . . . . .	338
9.1.4.1	How to Configure the DynDNS Service. . . . .	339
9.1.4.2	How to Define the Mail Exchanger . . . . .	342
9.2	CO Access via ITSP . . . . .	343
9.2.1	Configuring an ITSP . . . . .	344
9.2.1.1	How to Configure a Predefined ITSP . . . . .	346
9.2.1.2	How to Add a New ITSP . . . . .	353
9.2.1.3	How to Configure Multi-Sites over ITSPs . . . . .	360
9.2.1.4	How to Save a Preconfigured ITSP Template as a New Template. . . . .	361
9.2.1.5	How to Customize a Preconfigured ITSP Template . . . . .	362
9.2.1.6	How to Manually Update a Preconfigured ITSP Template . . . . .	363
9.2.2	STUN (Simple Traversal of UDP through NAT) . . . . .	363
9.2.2.1	How to Set the STUN Mode . . . . .	364
9.3	CO Access over Digital and Analog Lines . . . . .	365
9.3.1	Trunks . . . . .	365
9.3.1.1	How to Configure an ISDN Outside Line. . . . .	366
9.3.1.2	How to Configure an Analog Outside Line . . . . .	367

## Contents

9.3.1.3	How to Display All Trunks	368
9.3.1.4	How to Display Individual Trunks	369
9.3.1.5	How to Change the Trunk Code	369
9.3.1.6	How to Assign an MSN to a Trunk	369
9.3.1.7	ISDN protocol, modify	370
9.3.1.8	How to Change the B Channel Seizure Mode	370
9.3.1.9	How to Change the Dialing Method	371
9.3.2	Routes	371
9.3.2.1	How to Change a Route Assignment	374
9.3.2.2	How to Change the Route Name	374
9.3.2.3	How to Change the Seizure Code	375
9.3.2.4	How to Configure an Overflow Route with LCR Disabled	375
9.3.2.5	How to Configure an Overflow Route with LCR Enabled	375
9.3.2.6	How to Configure the Type of Seizure	376
9.3.2.7	How to Enter the PABX Number Incoming and Outgoing	376
9.3.2.8	How to Configure the Format of the Transmitted Call Number	377
9.3.2.9	How to Configure the Type of the Transmitted Call Number	377
9.3.2.10	How to Configure the Direction Prefix	377
9.3.2.11	How to Define a Route for Networking and Enter a Second CO Code	378
9.3.3	Dial Tone Monitoring	379
9.3.3.1	How to Configure a Delay Period for Dial Tone Monitoring	380
9.3.3.2	How to Configure the Dial Tone Monitoring Time	380
9.3.3.3	How to Configure the Digit Dial Time	381
9.3.3.4	How to Enable or Disable the Analysis of the Second Dial Tone	382
9.4	Prioritizing the Exchange Line Seizure with LCR Enabled	382
9.4.1	How to Prioritize the Seizure of Exchange Lines	382
<b>10</b>	<b>Stations</b>	<b>384</b>
10.1	Dial Plan	384
10.1.1	Default Dial Plan	385
10.1.2	Individual Dial Plan	386
10.1.2.1	How to Delete or Edit Default Phone Numbers	386
10.1.2.2	How to Edit Special Default Call Numbers	387
10.1.2.3	How to Import Call Numbers and Station Data	388
10.2	LAN Telephony Requirements	389
10.2.1	Audio Codecs	389
10.2.1.1	How to Configure Audio Codec Parameters	390
10.2.1.2	How to Assign Audio Codec Parameters to a Destination	391
10.2.2	Transmission of Tones According to RFC 2833	392
10.2.2.1	How to Enable or Disable Transmission of Fax/Modem Tones According to RFC2833	392
10.2.2.2	How to Enable or Disable Transmission of DTMF Tones According to RFC2833	393
10.2.3	Quality of Service	394
10.2.3.1	How to Configure Quality of Service (QoS)	396
10.3	IP Stations	397
10.4	SIP Stations	398
10.5	UP0 stations	400
10.6	DECT stations	401
10.7	ISDN Stations	402
10.7.1	How to Configure the S <sub>0</sub> Interface for ISDN Stations	403
10.7.2	How to Allow only Configured Numbers for MSNs	404
10.8	Analog Stations	405
10.9	Virtual Stations	406

10.10	Key programming	407
10.10.1	How to Program the Function Keys on the System Phones	408
10.11	Station Profiles	409
10.12	Configuring Stations	410
10.12.1	How to Configure IP Stations	412
10.12.2	How to Configure SIP Stations	415
10.12.3	How to Configure UP0 Stations	419
10.12.4	How to Configure DECT Stations	422
10.12.5	How to Configure ISDN Stations	425
10.12.6	How to Configure Analog Stations	428
10.12.7	How to Edit Station Names	430
10.13	Configuring Station Profiles	431
10.13.1	How to Create a New Station Profile	432
10.13.2	How to Display Station Profiles and their Members	433
10.13.3	How to Add Members to a Station Profile	433
10.13.4	How to Delete Members from a Station Profile	434
10.13.5	How to Export or Import a Single Station Profile	435
10.13.6	How to Change Values and Settings of a Station Profile	436
10.13.7	How to Export or Import all Station Profiles	437
10.14	Configuring the Authentication Data at the SIP Phone	438
10.14.1	How to Configure the Authentication Data via the WBM of the SIP Phone	438
10.14.2	How to Configure the Authentication Data on the Display of the SIP Phone	440
10.15	Exporting Subscriber Data	441
10.15.1	How to Export the Station Data	442
<b>11</b>	<b>UC Smart</b>	<b>443</b>
11.1	Basic Settings for UC Smart	444
11.1.1	How to Activate UC Smart	445
11.1.2	How to Configure UC Smart	445
11.1.3	How to Configure Application-controlled Conferences	446
11.1.4	How to Determine the IP Addresses of the System Components	447
11.1.5	How to Determine the Status of C Smart	448
11.2	UC Smart Clients	448
11.2.1	myPortal Smart	449
11.2.2	myPortal for OpenStage	449
11.2.3	Prerequisites for myPortal Smart	449
11.2.4	Prerequisites for myPortal for OpenStage	451
11.3	Users of UC Smart	451
11.3.1	How to Configure UC Smart Users	452
11.3.2	How to Change the Password for a UC Smart User	453
11.4	Presence Status (Presence)	453
11.5	Directories and Journal	454
11.5.1	Directories	454
11.5.1.1	How to Configure Directories for System Telephones	455
11.5.2	Internal Directory	456
11.5.2.1	How to Enable or Disable the Display of Stations in the Internal Directory	456
11.5.3	Favorites List	457
11.5.4	System Directory	457
11.5.5	Unified Directory	457
11.5.5.1	Features	458
11.5.5.2	Rules and Conventions	461
11.5.5.3	Functional Boundaries	462

## Contents

11.5.5.4 Unified Directory in Networked Systems . . . . .	463
11.5.6 Journal . . . . .	463
11.6 Calls . . . . .	464
11.6.1 Call Number Formats . . . . .	464
11.7 Conferences . . . . .	465
11.8 Web Collaboration . . . . .	467
11.8.1 How to Configure the Connection to the Web Collaboration Server (Public Server) . . . . .	468
11.8.2 How to Disable the Connection to the Web Collaboration Server . . . . .	469
11.9 Instant Messaging . . . . .	469
11.9.1 Instant Messaging . . . . .	469
11.10 Voicemail Box (SmartVM) . . . . .	469
11.10.1 Configuring the Voicemail Box (SmartVM) . . . . .	472
11.10.1.1 How to Disable or Enable the Voicemail Box . . . . .	473
11.10.1.2 How to Configure the Voicemail Box (SmartVM) . . . . .	473
11.10.1.3 How to Add a Standard Voicemail Box for a Subscriber . . . . .	475
11.10.1.4 How to Change the COS Group for a Voicemail Box Port . . . . .	476
11.10.1.5 How to Change the Structure of the Phone Menu for the Voicemail Box . . . . .	476
11.10.1.6 How to Load, Save and Delete Individual Greetings . . . . .	477
11.10.1.7 How to Back up and Restore Greetings and Messages . . . . .	477
11.10.2 Notification Service for Messages . . . . .	478
11.10.2.1 How to Enable or Disable E-mail Notifications . . . . .	479
<b>12 UC Suite . . . . .</b>	<b>480</b>
12.1 Basic Settings for UC Suite . . . . .	480
12.1.1 How to Activate UC Suite . . . . .	481
12.1.2 How to Restrict the Authorization for UC Calls Initiated by the System . . . . .	481
12.2 UC Suite Clients . . . . .	482
12.2.1 myPortal for Desktop . . . . .	482
12.2.1.1 How to Customize an an Alternative Modern User Interface for myPortal for Desktop . . . . .	483
12.2.1.2 How to Delete the Alternative Modern User Interface for myPortal for Desktop . . . . .	483
12.2.2 myPortal for Outlook . . . . .	484
12.2.3 Fax Printer . . . . .	484
12.2.4 myAttendant . . . . .	484
12.2.5 myPortal for OpenStage . . . . .	485
12.2.6 Prerequisites for UC Suite PC Clients . . . . .	485
12.2.7 Prerequisites for myPortal for OpenStage . . . . .	489
12.2.8 Silent Installation/Uninstallation for UC Suite PC Clients . . . . .	489
12.2.8.1 How to Perform a Silent Installation . . . . .	490
12.2.8.2 How to Perform a Silent Uninstallation . . . . .	491
12.2.9 Automatic Updates . . . . .	492
12.3 Users and User Profiles of the UC Suite . . . . .	493
12.3.1 Users of UC Suite . . . . .	493
12.3.1.1 How to Configure UC Suite Users . . . . .	495
12.3.1.2 How to Reset UC Suite Users . . . . .	496
12.3.1.3 How to Configure UC Suite Users as Agents (myAgent) . . . . .	496
12.3.1.4 How to Change the Presence Status for a UC Suite User . . . . .	497
12.3.1.5 How to Change the Password for a UC Suite User . . . . .	497
12.3.1.6 How to Change the Password Length for UC Suite Users . . . . .	498
12.3.2 User Profiles for the UC Suite . . . . .	498
12.3.2.1 How to Add a UC Suite User Profile . . . . .	499
12.3.2.2 How to Edit a User Profile of the UC Suite . . . . .	500
12.3.2.3 How to Display the User Profiles of the UC Suite . . . . .	500

12.3.2.4	How to Add Members to a UC Suite User Profile	500
12.3.2.5	How to Delete Members from a UC Suite User Profile	501
12.3.2.6	How to Delete a UC Suite User Profile	501
12.4	Presence Status and CallMe Service	502
12.4.1	Presence Status (Presence)	502
12.4.2	CallMe Service	505
12.4.3	Status-based Call Forwarding	506
12.4.4	Rule-Based Call Forwarding	506
12.5	Directories and Journal	507
12.5.1	Directories	507
12.5.1.1	How to Configure Directories for System Telephones	509
12.5.2	Internal Directory	510
12.5.2.1	How to Enable or Disable the Display of Analog Stations in the Internal Directory	510
12.5.2.2	How to Enable or Disable Searching the Internal Directory only	511
12.5.3	External Directory	511
12.5.3.1	How to Import a CSV File from the Local File System into the External Directory	513
12.5.3.2	How to Add Access to an External Database for the External Directory	514
12.5.4	External Offline Directory (LDAP)	514
12.5.4.1	How to Add the External Offline Directory (LDAP) for PC Clients	515
12.5.4.2	How to Delete the External Offline Directory (LDAP) for PC Clients	516
12.5.4.3	How to Add an External Offline Directory (LDAP) for System Telephones	516
12.5.5	System Directory	517
12.5.6	Unified Directory	517
12.5.6.1	Features	518
12.5.6.2	Rules and Conventions	521
12.5.6.3	Functional Boundaries	522
12.5.6.4	Unified Directory in Networked Systems	523
12.5.6.5	How to Import Contacts to Unified Directory	523
12.5.6.6	How to Edit or Add new Unified Directory Contacts	525
12.5.7	Departments	525
12.5.7.1	How to Add a Department	525
12.5.7.2	How to Assign Stations to a Department	526
12.5.7.3	How to Edit a Department	526
12.5.7.4	How to remove a Department	526
12.5.8	Favorites List	527
12.5.9	Journal	527
12.5.9.1	How to Change the Maximum Retention Period for the Journal	529
12.6	Calls	529
12.6.1	Desktop Dialer and Clipboard Dialer	529
12.6.2	Screen Pops	530
12.6.3	Record calls	530
12.6.3.1	How to Activate or Deactivate the Recording of Calls	531
12.6.3.2	How to Activate or Deactivate the Recording Announcement	531
12.6.3.3	How to Activate or Deactivate the Warning Tone for Recording	532
12.7	Conferences	532
12.7.1	Conference Management	532
12.7.1.1	How to Change the Dial-in Number for a Virtual Conference Room	536
12.7.1.2	Allowing or Preventing Multiple External Conference Participants	537
12.7.1.3	How to Activate or Deactivate the Conference Tone	537
12.7.1.4	How to Change the Time Interval for the Automatic Termination of a Conference	538
12.7.1.5	How to Check the Details of a Saved Conference	538
12.7.1.6	How to Delete a Saved Conference	538

## Contents

12.7.1.7	How to Configure the Recording of Conferences	539
12.7.2	Ad-hoc Conference	539
12.7.3	Scheduled Conference	540
12.7.4	Permanent Conference	542
12.7.5	Open Conference	543
12.8	Web Collaboration	543
12.8.1	How to Configure the Connection to the Web Collaboration Server (Custom Server)	545
12.8.2	How to Configure the Connection to the Web Collaboration Server (Public Server)	546
12.8.3	How to Disable the Connection to the Web Collaboration Server	547
12.9	Instant Messaging	547
12.9.1	Instant Messaging	547
12.9.1.1	How to Enable or Disable Instant Messaging	548
12.10	AutoAttendant	549
12.10.1	Personal AutoAttendant	549
12.11	Voice and fax messages	549
12.11.1	Voicemail Box	549
12.11.1.1	How to Configure Station Numbers for Voicemail	551
12.11.1.2	How to Configure Call Forwarding to a Voicemail Box	552
12.11.1.3	How to Configure the Parameters of the Voicemail Box	552
12.11.1.4	How to Configure Retention Periods for Voicemail	553
12.11.1.5	How to Activate or Deactivate the Password Prompt for the Voicemail Box	553
12.11.1.6	How to Configure an Info for Received Voicemails	554
12.11.1.7	How to Configure a Mailbox Key to Check Voicemail	554
12.11.2	Voicemail Announcements	555
12.11.2.1	How to Import Announcements for the Voicemail Box	556
12.11.2.2	How to Change the Language for Voicemail Announcements	557
12.11.3	Fax Box	557
12.11.3.1	How to Add a Fax Box for Stations	558
12.11.3.2	How to Configure the File Type for Stored Fax Messages (UC Suite)	559
12.11.4	Sending Fax Messages with Fax Printer	559
12.11.4.1	How to Add a Central Cover Page	560
12.11.4.2	How to Edit a Central Cover Page	560
12.11.4.3	How to Add a Header Line for the Fax Printer	561
12.11.4.4	How to Edit a Header Line for Fax Printer	561
12.11.4.5	How to Delete a Header Line for Fax Printer	562
12.11.5	Notification Service for New Messages (UC Suite)	562
12.11.6	Sending E-mails	563
12.11.6.1	How to Configure the Sending of E-mails	564
12.11.7	SMS Template	565
12.11.7.1	How to Add an SMS Template	565
12.11.7.2	How to Edit an SMS Template	566
12.11.7.3	How to Remove an SMS Template	567
12.11.8	Fax over IP (T.38 / G.711 Fax)	567
12.11.8.1	How Enable or Disable Fax over IP (T.38 Fax)	568
<b>13</b>	<b>Functions at the Telephone</b>	<b>569</b>
13.1	Making Call	569
13.1.1	Digit Dialing	569
13.1.2	En-Bloc Dialing	569
13.1.3	Keypad dial	569
13.1.4	End-of-Dialing Recognition	570
13.1.5	Editing the Telephone Number	570

13.1.5.1	How to Activate or Deactivate Editing of the Telephone Number	571
13.1.6	Redialing	571
13.1.6.1	How to Enable or Disable Automatic Redialing	572
13.1.7	System Speed Dialing	572
13.1.7.1	How to Add a Speed Dial	574
13.1.7.2	How to Import Speed Dials from an XML or CSV File	574
13.1.7.3	How to Export Speed Dials to an XML File	575
13.1.7.4	How to Edit Speed Dials	575
13.1.8	Individual Speed Dialing (ISD)	576
13.1.9	Direct station select	576
13.1.10	Speaker Calls / Direct Answering	577
13.1.10.1	How to Enable or Disable the Prevention of Speaker Calls for Stations	578
13.1.11	Associated Dialing	578
13.1.12	Trunk Queuing	579
13.1.12.1	How to Activate or Deactivate Trunk Queuing	579
13.1.13	Private Trunk	580
13.2	Call Signaling, Calling Line ID	580
13.2.1	Different Call Signaling	580
13.2.2	Calling Line Identification Presentation (CLIP)	581
13.2.2.1	How to Enable or Disable Configurable CLIP	581
13.2.3	Calling Line Identification Restriction (CLIR)	582
13.2.3.1	How to Enable or Disable Station Number Suppression	582
13.2.4	Connected Line Identification Presentation (COLP)	583
13.2.4.1	How to Enable or Disable Connected Line Identification Presentation (COLP)	583
13.2.5	Connected Line Identification Restriction (COLR)	584
13.2.6	CLIP No Screening (Transmission of Customer-Specific Phone Number Information)	584
13.2.6.1	How to Configure CLIP No Screening	585
13.2.7	CLIP for Analog Telephones	585
13.2.8	Ringer Cutoff	585
13.2.9	Translating Station Numbers to Names for System Speed Dialing	585
13.3	Functions During the Call	586
13.3.1	Placing a Call on Hold	586
13.3.2	Parking	586
13.3.3	Consultation	587
13.3.4	Toggle/Connect	588
13.3.5	Transfer	588
13.3.6	Automatic Recall	589
13.3.7	Call Supervision (Selected Countries Only)	589
13.3.7.1	How to Activate or Deactivate Call Monitoring for a Station	590
13.3.8	Discreet Call (Whisper)	591
13.3.9	Live Call Recording (Voice Recording)	592
13.4	Controlling Availability	593
13.4.1	Call Forwarding	594
13.4.1.1	How to Configure Call Forwarding	595
13.4.2	Call Forwarding (CF)	597
13.4.2.1	How to Enable or Disable Call Forwarding over Analog Trunks	598
13.4.2.2	How to Enable or Disable Call Forwarding to the External Destination	599
13.4.3	Call Forwarding After Timeout	599
13.4.4	External Call Forwarding - No Answer (Not for U.S.)	600
13.4.5	Ringling Assignment / Call Allocation	600
13.4.5.1	How to How to Configure a Ringling Assignment	601
13.4.6	Ringling group on	601

## Contents

13.4.7	Rejecting Calls	602
13.4.8	Deferring a Call	603
13.4.9	Do Not Disturb	603
13.5	Optimizing Communication	604
13.5.1	Callback	604
13.5.2	Call Waiting	605
13.5.2.1	How to Enable or Disable Call Waiting	606
13.5.2.2	How to Enable or Disable Immediate Call Waiting (Camp On) by the Attendant Console	606
13.5.3	Override (Intrusion)	607
13.5.3.1	How to Authorize an Internal Station for the Override Feature	607
13.5.3.2	How to Authorize the Intercept Position for the Override Feature	608
13.5.4	Advisory Messages	608
13.5.4.1	How to Edit Advisory Messages	608
13.5.5	Message Texts	609
13.5.5.1	How to Change a Message Text	609
13.5.6	Associated Services	610
13.5.6.1	How to Activate or Deactivate Associated Services	610
13.5.7	DISA	611
13.5.7.1	How to Activate or Deactivate a DISA Class of Service for a Station	612
13.5.7.2	How to Configure a DISA Number	612
13.5.7.3	How to Configure the DISA Security Mode	612
13.5.8	Flex Call/Mobile PIN	613
13.5.9	Relocate	613
13.5.9.1	How to Unlock Relocate on a System-wide Basis	614
13.5.10	Reset activated features	614
13.5.11	Procedures	615
13.5.12	Automatic Wake-up System and Timed Reminders	616
<b>14</b>	<b>Working in a Team (Groups)</b>	<b>617</b>
14.1	Call Pickup Group, Group Call and Hunt Group	617
14.1.1	Call Pickup Group	617
14.1.2	Group Call	619
14.1.3	Hunt Group	623
14.1.4	Configuring Call Pickup Groups, Group Calls and Hunt Groups using Wizards	626
14.1.4.1	How to Configure a Call Pickup Group	626
14.1.4.2	How to Add or Delete a Member to or from a Call Pickup Group	627
14.1.4.3	How to Add a Group Call (Group)	628
14.1.4.4	How to Edit a Group Call (Group)	629
14.1.4.5	How to Delete a Group Call (Group)	630
14.1.4.6	How to Add or Delete a Member to or from a Group Call (Group)	630
14.1.4.7	How to Add a Hunt Group	631
14.1.4.8	How to Change a Hunt Group	632
14.1.4.9	How to Delete a Hunt Group	633
14.1.4.10	How to Add or Delete a Member to or from a Hunt Group	634
14.1.5	Configuring Call Pickup Groups, Group Calls and Hunt Groups using Expert Mode	635
14.1.5.1	How to Enable or Disable the Display of a Caller's Station Number and Name	635
14.1.5.2	How to Activate or Deactivate the Warning Tone	636
14.1.5.3	How to Enable or Disable Call Pickup for Recalls	636
14.1.5.4	How to Add a Group Call (RNA or Call Waiting)	637
14.1.5.5	How to Display or Edit a Group Call (RNA or Call waiting)	637
14.1.5.6	How to Delete a Group Call (RNA or Call Waiting)	638
14.1.5.7	How to Add or Delete a Member to or from a Group Call (RNA or Call Waiting)	638



14.1.5.8	How to Enable or Disable Do Not Disturb for a Group Member	639
14.2	Team Configuration / Team Group and Executive/Secretary / Top Group	640
14.2.1	Team Configuration / Team Group	640
14.2.2	Executive/Secretary or Top Group	643
14.2.3	Configuring Team Configurations / Team Groups and Executive/Secretary Functions / Top Groups using Wizards	647
14.2.3.1	How to Add a Team Configuration / Team Group	647
14.2.3.2	How to Edit a Team Configuration / Team Group	649
14.2.3.3	How to Delete a Team Configuration / Team Group	649
14.2.3.4	How to Add an Executive/Secretary or Top Group	650
14.2.3.5	How to Edit an Executive/Secretary or Top Group	651
14.2.3.6	How to Delete an Executive / Secretary or Top Group	652
14.2.4	Configuring Team configurations / Team groups and Executive/Secretary functions / Top groups using Expert mode	653
14.2.4.1	How to Add or Delete a Member to or from a Team Configuration or Team Group	653
14.2.4.2	How to Edit a Member of a Team Configuration / Team Group	654
14.2.4.3	How to Edit the Properties of Members in a Team Group	654
14.2.4.4	How to Change the Programmed Feature Keys for a Team Configuration / Team Group	655
14.2.4.5	How to Add a Fax Box to a Team Configuration / Team Group	655
14.2.4.6	How to Add or Delete a Member to or from an Executive/Secretary or Top Group	656
14.2.4.7	How to Edit a Member of an Executive/Secretary or Top Group	656
14.2.4.8	How to Edit the Properties of an Executive/Secretary or Top Group	657
14.2.4.9	How to Add a Fax Box to an Executive/Secretary or Top Group	657
14.3	Basic MULAP and Executive MULAP	657
14.3.1	Basic MULAP	658
14.3.2	Executive MULAP	660
14.3.3	Configuring Basic MULAPs and Executive MULAPs	663
14.3.3.1	How to Add a Basic MULAP	663
14.3.3.2	How to Display or Edit a Basic MULAP	664
14.3.3.3	How to Delete a Basic MULAP	664
14.3.3.4	How to Add or Delete a Member to or from a Basic MULAP	665
14.3.3.5	How to Edit a Member of a Basic MULAP	665
14.3.3.6	How to Add an Executive MULAP	666
14.3.3.7	How to Display or Edit an Executive MULAP	667
14.3.3.8	How to Delete an Executive MULAP	667
14.3.3.9	How to Add or Delete a Member to or from an Executive MULAP	668
14.3.3.10	How to Edit a Member of an Executive MULAP	668
14.4	Voicemail Group and Fax Box Group	669
14.4.1	Voicemail Group	669
14.4.2	Fax Box Group	670
14.4.3	Configuring Voicemail Box Groups and Fax Box Groups	670
14.4.3.1	How to Add a Voicemail Group	670
14.4.3.2	How to Display or Edit a Voicemail Group	671
14.4.3.3	How to Delete a Voicemail Group	671
14.4.3.4	How to Add or Delete a Member to a Voicemail Group	672
14.4.3.5	How to Edit a Member of a Voicemail Group	672
14.4.3.6	How to Configure a Fax Box Group	673
14.4.3.7	How to Display or Edit a Fax Box Group	674
14.4.3.8	How to Delete a Fax Box Group	674
14.4.3.9	How to Add or Delete a Member to a Fax Box Group	674
14.5	Speaker Call for Groups	675
14.5.1	Internal Paging	675

## Contents

14.5.2	Transfer to Group from Announcement	676
14.6	UCD (Uniform Call Distribution)	676
14.6.1	Call Distribution / UCD Group	677
14.6.1.1	How to Configure Call Distribution / UCD Groups	678
14.6.2	UCD Agents	679
14.6.2.1	How to Add or Delete UCD Agents	680
14.6.3	Wrap up	681
14.6.3.1	How to Change the Automatic Wrap-Up Time	682
14.6.4	Call Prioritization	682
14.6.4.1	How to Change Request Priorities	683
14.6.5	Accepting UCD Calls Automatically	683
14.6.5.1	How to Change the Automatic Acceptance of UCD Calls	683
14.6.6	UCD queue	684
14.6.6.1	How to Change the UCD Queue	685
14.6.7	UCD Overflow	685
14.6.7.1	How to Change the UCD Overflow	686
14.6.8	UCD Night Service	686
14.6.9	Announcements / Music on Hold for UCD	687
14.6.9.1	How to Change Announcements / Music on Hold for UCD	688
14.6.10	Transfer to UCD Groups	688
14.6.10.1	How to Edit the Recall Time for Calls Transferred to UCD Groups	689
14.6.11	Releasing UCD from Analog Lines	689
14.6.11.1	How to Edit the Release Time for UCD Calls over Analog Trunks	689
<b>15</b>	<b>Call Routing</b>	<b>691</b>
15.1	Classes of Service (Toll Restriction)	691
15.1.1	Class of Service (COS) Groups and Classes of Service	691
15.1.1.1	How to Edit COS Group Names	692
15.1.1.2	How to Edit the Classes of Service of a COS Group	692
15.1.1.3	How to Display All Stations of a COS Group	693
15.1.2	Allowed and Denied Lists	693
15.1.2.1	How to Create a List of Emergency Numbers	694
15.1.2.2	How to Create an Allowed and a Denied List	695
15.1.2.3	How to Create Additional Allowed Lists	695
15.1.2.4	How to Create Additional Denied Lists	696
15.1.2.5	How to Display all Call Numbers in a Denied List	696
15.1.2.6	How to Display all Call Numbers in an Allowed List	697
15.1.2.7	How to Edit the Analysis Filter for the Denied List	697
15.1.3	Night Service	697
15.1.3.1	How to Assign Classes of Service for the (Manual) Night Service	698
15.1.3.2	How to Delete Classes of Service for the Manual Night Service	699
15.1.3.3	How to Configure the Scheduled Night Service	700
15.1.3.4	How to Configure a Special Day for the Scheduled Night Service	700
15.1.3.5	How to Delete a Special Day for the Scheduled Night Service	701
15.1.4	Automatic COS Changeover after Time	701
15.1.4.1	Schedule	702
15.1.5	CON Groups	703
15.1.5.1	CON groups (traffic restriction groups)	703
15.1.5.2	Assigning Speed-Dialing Numbers to CON groups	704
15.1.5.3	How to Assign Stations to a CON Group	704
15.1.5.4	How to Assign a Trunk to a CON Group	705
15.1.5.5	How to Edit the CON Matrix	705

15.1.6	System Telephone Lock (COS Changeover)	705
15.1.7	Individual Lock Code (Locking the Phone)	706
15.1.7.1	How to Reset the Individual Lock Code	706
15.1.8	Collect Call Barring per Trunk (for Brazil only)	707
15.1.9	Ringback Protection per Station (for Brazil only)	707
15.2	LCR (Least Cost Routing)	707
15.2.1	LCR Functionality	708
15.2.1.1	How to Release LCR	710
15.2.2	LCR Dial Plan	710
15.2.2.1	How to Edit the Dial Plan	712
15.2.3	LCR Routing Table	713
15.2.3.1	How to Edit Routing Tables	713
15.2.4	LCR Class of Service	714
15.2.4.1	How to Assign and Change an LCR Class of Service	715
15.2.5	LCR Outdial Rules	715
15.2.5.1	How to Edit the Outdial Rules	717
15.2.6	Network carriers	718
15.2.7	Selective Seizure of Exchange Lines	719
15.2.7.1	How to Configure the Code for the Selective Seizure of ISDN Trunks	719
15.2.7.2	How to Display the Seizure Code for the 'Outside Line Seizure'	720
15.3	Digit Analysis and Call Routing	720
15.3.1	Overview of Call Routing / LCR	721
15.3.2	Digit Analysis Flowchart	723
15.3.3	Call Routing and LCR in the Internetwork	724
15.3.3.1	Dedicated Gateway	726
15.3.4	Scenarios: Digit Analysis and Call Routing	727
15.3.4.1	Subscriber A Calls Subscriber B via an Internal Phone Number	728
15.3.4.2	Subscriber A calls subscriber B via a public phone number	730
15.3.4.3	Subscriber A calls an external station via the CO	733
15.3.4.4	ISDN trunk calls subscriber A	735
15.3.4.5	Special Configurations	737
15.3.4.6	Subscriber A Calls Subscriber C via an Internal Phone Number	739
15.3.4.7	Subscriber A calls subscriber C via a public number in the internetwork	742
15.3.4.8	ISDN trunk calls subscriber C	744
15.3.4.9	ISDN Trunk Gateway 1 Calls Subscriber D	746
15.3.4.10	Subscriber D calls external station via the CO	750
15.4	Emergency Calls	752
15.4.1	Hotline after Timeout / Hotline	754
15.4.1.1	How to Configure and Change the Hotline Destination	754
15.4.1.2	How to Change the Hotline Timeout	755
15.4.1.3	How to Configure an Off-Hook Alarm after Timeout or Hotline for a Station	755
15.4.2	Trunk Release for Emergency Call	755
15.4.2.1	How to Activate and Deactivate Trunk Release for Emergency Call	756
15.4.3	For U.S. and Canada only: E911 Emergency Call Service	756
15.4.3.1	How to Edit CLIP / Lin	757
15.4.4	Emergency Calls in Combination with Mobile Logon	757
15.4.4.1	Configuring the Emergency Scenario	758
15.4.5	E112 Emergency Call Service for Europe	760
15.4.5.1	How to add ITSP-Loc ID to a station	761
15.5	Call Admission Control	761
15.5.1	Limiting the Number of Simultaneous Calls via an ITSP	761
15.5.2	Restricting the bandwidth requirements for gateway calls	762

## Contents

15.5.3	Limiting the Number of Calls in Networking Scenarios	762
15.6	Tenant system	762
15.6.1	System Speed Dialing in Tenant Systems	764
<b>16</b>	<b>Attendants</b>	<b>765</b>
16.1	AutoAttendant	765
16.1.1	Company AutoAttendant (UC Smart)	767
16.1.1.1	How to Configure an Established Company AutoAttendant	768
16.1.1.2	How to Set up a New Company AutoAttendant	769
16.1.2	Company AutoAttendant (UC Suite)	771
16.1.2.1	Schedules	771
16.1.2.2	Templates	778
16.1.3	Xpressions Compact	782
16.2	OpenStage Attendant	782
16.3	OpenScape Business Attendant	783
16.3.1	OpenScape Business BLF	786
16.3.2	Configuration Examples for OpenScape Business Attendant, OpenScape Business BLF	786
16.3.2.1	Scenario 1: OpenScape Business Attendant Connected to an OpenScape Business Single System	787
16.3.2.2	Scenario 2: Two or More OpenScape Business Attendants Connected to an OpenScape Business Single System	793
16.3.2.3	Scenario 3: OpenScape Business Network with Individual OpenScape Business Attendants (Network-wide BLF and Presence Status via WSI)	795
16.3.2.4	Scenario 4: OpenScape Business Network with central OpenScape Business Attendant (Network-wide BLF and Presence Status via WSI)	795
16.3.2.5	Scenario 5: OpenScape Business BLF Connected to an OpenScape Business Single System	796
16.3.2.6	Scenario 6: OpenScape Business BLF Connected to an OpenScape Business Internetwork (BLF and Presence Status via WSI)	798
16.4	myAttendant	799
16.4.1	Subscriber Management	800
16.4.2	Message Center	800
16.4.3	Scenario 1: How to Configure a myAttendant connected to an OpenScape Business Single System	801
16.4.4	Scenario 2: How to Configure Two or More myAttendants connected to an OpenScape Business Single System	802
16.4.5	Scenario 3: How to Set Up an OpenScape Business Network with a Central myAttendant	803
16.5	Intercept Position	804
16.5.1	How to Configure the Intercept Position and Intercept Criteria	806
16.5.2	How to Configure the Central Intercept Position	807
16.5.3	How to Configure the Telephone Lock Intercept	807
16.5.4	How to Configure the Intercept Announcement	808
<b>17</b>	<b>Multimedia Contact Center</b>	<b>809</b>
17.1	Contact Center Clients	809
17.1.1	myAgent	810
17.1.2	Prerequisites for myAgent	811
17.1.3	myReports	813
17.1.3.1	How to Reset the myReports Administrator Password	814
17.1.4	Prerequisites for myReports	815
17.1.5	Notes on Using myAgent and UC Suite Clients Simultaneously	817
17.2	Agents	818
17.2.1	Agent Functions Independent of the Authorization Level	818
17.2.2	Preferred Agents	819

17.2.3	Agents in multiple queues	819
17.2.4	Contact Center Breaks	820
17.2.5	Agent Login/Logout via Telephone	820
17.3	Queues and Schedules	823
17.3.1	Queues	823
17.3.2	Schedules	825
17.3.3	Wrap up	832
17.3.4	Grade of Service	833
17.3.5	Wallboard	833
17.3.6	Agent Callback	833
17.4	VIP service	833
17.4.1	VIP Caller Priority	834
17.4.2	VIP Call List	834
17.5	Fallback solution	835
17.6	Configuring the Contact Center	837
17.6.1	Example of a Contact Center Configuration	838
17.6.1.1	How to Configure UCD Groups for the Sample Contact Center	840
17.6.1.2	How to Configure a Fallback Solution for the Sample Contact Center	841
17.6.1.3	How to Configure a Subscriber as an Agent for the Sample Contact Center	842
17.6.1.4	How to Add Announcements for the Sample Contact Center	843
17.6.1.5	How to Load Announcements for the Sample Contact Center	843
17.6.1.6	How to Add the Standard Schedule XYZ for the Sample Contact Center	844
17.6.1.7	How to Add the Standard Schedule Hotline for the Sample Contact Center	849
17.6.1.8	How to Add Queues for the Sample Contact Center	850
17.6.1.9	How to Assign Agents to Queues of the Sample Contact Center	852
17.6.2	Configuration Procedure	854
17.6.2.1	How to Configure UCD Groups for the Contact Center	854
17.6.2.2	How to Configure a Subscriber as an Agent	855
17.6.2.3	How to Record Custom Announcements for the Contact Center	856
17.6.2.4	How to Load Custom Announcements for the Contact Center	857
17.6.2.5	How to Add a Schedule	857
17.6.2.6	How to Edit a Schedule	860
17.6.2.7	How to Delete a Schedule	861
17.6.2.8	How to Save a Rule (CCV) as a PDF File	862
17.6.2.9	How to Add a Queue	862
17.6.2.10	How to Edit a Queue	866
17.6.2.11	How to Activate or Deactivate a Queue	868
17.6.2.12	How to Configure a Pilot for Incoming Fax Messages in Queues	868
17.6.2.13	How to Define Target Values for the Grade Of Service	869
17.6.2.14	How to Define the VIP Caller Priority	870
17.6.2.15	How to Edit the VIP Call List	870
17.6.2.16	How to Define Preferred Agents	871
17.6.2.17	How to Delete Preferred Agents	872
17.6.2.18	How to Add a Contact Center Break	872
17.6.2.19	How to Edit a Contact Center Break	873
17.6.2.20	How to Delete a Contact Center Break	873
17.6.2.21	How to Add a Wrapup Reason for a "Simple Wrapup"	874
17.6.2.22	How to Edit a Wrapup Reason for a "Simple Wrapup"	874
17.6.2.23	How to Delete a Wrapup Reason for a "Simple Wrapup"	875
17.6.2.24	How to Add a Wrapup Reason for a "Multiple Wrapup"	875
17.6.2.25	How to Edit a Wrapup Reason for a "Multiple Wrapup"	876
17.6.2.26	How to Delete a Wrapup Reason for a "Multiple Wrapup"	876

## Contents

17.6.2.27	How to Assign an Agent to a Queue	877
17.6.2.28	How to Remove an Agent from the Queue	878
17.7	Notes on Using the Contact Center	878
17.7.1	Restrictions on Operating the Contact Center	878
17.8	Notes on the Use of DECT Phones	881
17.9	Reports	882
17.9.1	Predefined Report Templates	883
<b>18</b>	<b>Mobility</b>	<b>884</b>
18.1	Integrated Mobility Solution	884
18.2	Mobility on the Road	884
18.2.1	myPortal to go	885
18.2.1.1	Prerequisites for myPortal to go	887
18.2.2	Mobility Entry	888
18.2.3	Comparison between Mobile Clients and Mobility Entry	890
18.2.4	Dependencies for Mobile Clients and Mobility Entry	891
18.2.5	One Number Service (ONS)	892
18.2.6	Dual-Mode Telephony	893
18.2.7	Configuring myPortal to go and Mobility Entry	893
18.2.7.1	How to Integrate GSM Mobile Phones	894
18.2.7.2	How to Integrate Dual-Mode Telephones (GSM/WLAN) with HFA or SIP Client	896
18.2.7.3	How to Enable the Web Interface for Mobile Phones and Web Clients	898
18.2.7.4	How to Delete Mobile Phone Integration	898
18.3	Mobility in the office	899
18.3.1	Desk Sharing	899
18.3.2	Integrated Cordless Solution	900
18.3.2.1	Cordless Direct Connections (DECT Light)	902
18.3.2.2	Connecting Cordless Boards	902
18.3.2.3	System Configuration	903
18.3.2.4	Cordless/DECT Phones	904
18.3.3	Configuring the Integrated Cordless Solution	905
18.3.3.1	How to Configure the DECT System ID and Other Cordless Parameters (System-wide Data)	906
18.3.3.2	How to Configure Cordless Base Stations	906
18.3.3.3	How to configure DECT Phones for the First Time	907
18.3.3.4	How to Register a DECT Phone (OpenStage/Gigaset Handset) at the Cordless System	907
18.3.3.5	How to Add Additional DECT Phones	908
18.3.3.6	How to Delete DECT Telephones	909
18.3.3.7	How to Configure the Multi-SLC Parameters	909
18.3.3.8	How to Query the Data for Base Stations	910
18.3.3.9	How to Enable the Message Waiting Indication (MWI) for DECT Telephones	910
18.3.3.10	How to Check the Logon Status of DECT Phones	911
18.3.4	Cordless IP	911
18.3.5	WLAN Phones and Access Points	911
18.3.5.1	WLAN Requirements	912
18.4	Mobility at Home	912
18.4.1	Configuring a VPN	913
18.4.2	Configuration for SIP Device@Home	913
18.4.3	Configuration for System Device@Home	915
18.4.4	How to Enable Device@Home	918
18.4.5	How to Specify a STUN Server for Device@Home	918
<b>19</b>	<b>Security</b>	<b>920</b>
19.1	Firewall	920

19.1.1	Port Handling	920
19.1.1.1	Opening Ports	921
19.1.1.2	How to Configure the Opening of Ports	922
19.1.1.3	Port Management	922
19.1.1.4	How to Edit Global Port Management Settings	923
19.1.2	NAT	923
19.1.2.1	How to Configure a NAT Rule	924
19.1.2.2	How to Configure NAT Rules with the NAT Table Editor	925
19.1.2.3	How to Delete a NAT Rule	925
19.1.3	Application Firewall	926
19.1.3.1	How to Display the Configuration of the Application Firewall	927
19.1.3.2	How to Restrict Services using the Application Firewall	927
19.1.3.3	How to Delete the Configuration of the Application Firewall	928
19.1.4	Services Administration (OpenScape Business S)	928
19.1.4.1	How to Add or Block Services	928
19.2	Signaling and Payload Encryption (SPE)	929
19.2.1	How to Enable or Disable SPE Support	931
19.2.2	How Change the SPE Security Settings	931
19.2.3	How to Import an SPE Certificate and Private Key (PKCS#12)	931
19.2.4	How to Import an SPE CA Certificate	932
19.2.5	How to Enable or Disable SPE for a Station	933
19.3	Virtual Private Network (VPN)	933
19.3.1	Requirements for VPN	934
19.3.2	Connecting Teleworkers via a VPN	936
19.3.2.1	How to Connect Teleworkers via a VPN	937
19.3.2.2	How to Export Teleworker Data	939
19.3.3	Networking Communication Systems via a VPN	940
19.3.3.1	How to Configure Networking via a VPN	940
19.3.3.2	How to Import and Export the Topology Data of a VPN Network	943
19.3.4	VPN - Security Mechanisms	943
19.3.5	VPN - Certificates	945
19.3.5.1	VPN - How to Generate Lightweight CA Certificates	947
19.3.5.2	VPN - Certificate Management - How to View a Certificate	948
19.3.5.3	VPN - How to Import a Trusted CA Certificate (X.509)	948
19.3.5.4	VPN - Peer Certificates - How to Generate a Certificate Signing Request (CSR)	948
19.3.5.5	VPN - Peer Certificates - How to Generate a Certificate (PKCS#12)	949
19.3.5.6	VPN - How to Import a Peer Certificate (PKCS#12)	950
19.3.6	VPN Clients	951
19.3.6.1	NCP VPN Client Settings	952
19.3.6.2	How to Configure an NCP VPN Client	954
19.3.6.3	How to Configure a Shrew Soft VPN Client	954
19.3.6.4	How to Configure an iOS or Android VPN Client	955
19.3.6.5	How to Configure a Mac OS X VPN Client	956
19.3.7	VPN Services	957
19.3.7.1	VPN - Active Services - How to Display all IPsec Services	957
19.3.7.2	VPN - Active Services - How to Display a Special IPsec Service	957
19.3.7.3	VPN - Configured Services - How to Display all IPsec Services	957
19.3.7.4	VPN - Configured Services - How to Edit the IPsec Service	958
19.3.7.5	VPN - Configured Services - How to Rename the IPsec Service	958
19.3.7.6	VPN - Configured Services - How to Delete the IPsec Service	959
19.3.8	VPN tunnel	959
19.3.8.1	VPN - Active Tunnels - How to Display General Tunnel Data	959

## Contents

19.3.8.2	VPN - Active Tunnels - How to Display Rules for all Tunnels	960
19.3.8.3	VPN - Configured Tunnels - How to Display General Tunnel Data	960
19.3.8.4	VPN - Configured Tunnels - How to Display Rules for all Tunnels	961
19.3.8.5	VPN - How to Add a Configured Tunnel	961
19.3.9	VPN rules	963
19.3.9.1	VPN - Active Rules - How to Display Rules	963
19.3.9.2	VPN - Active Rules - How to Display Special Rules	964
19.3.9.3	VPN - Configured Rules - How to Display all Rules	964
19.3.9.4	VPN - Configured Rules - How to Add a Rule	965
19.3.9.5	VPN - How to Edit a Rule	966
19.3.9.6	VPN - How to Add a Rule for the Opposite Direction	966
19.3.9.7	VPN - How to Delete a Rule	967
19.3.10	PKI Server	967
19.3.10.1	VPN - How to Display the PKI Server	967
19.3.10.2	VPN - How to Add a PKI Server	968
19.4	Certificate Handling	968
19.4.1	How to Generate CA Certificates	969
19.4.2	How to Generate Self-Signed Certificates	970
19.4.3	How to Generate Certificate Signing Requests (CSR)	970
19.4.4	How to Import Server Certificates (PKCS#12)	971
19.4.5	How to Display Certificates	971
19.4.6	How to Delete Certificates	972
19.4.7	How to Export Certificates (X.509)	972
19.4.8	How to Import Updated Certificates (X.509)	972
19.4.9	How to Activate Certificates	973
19.5	Web Security	974
19.5.1	Connections to the Web Server	974
19.5.1.1	How to Configure Connections to the Web Server (UC Suite)	974
19.5.1.2	How to Configure Connections to the Web Server (UC Smart)	975
19.5.2	Admin Log (also called Admin Protocol)	975
19.5.2.1	How to Load the Admin Log	975
19.5.2.2	How to Change the Admin Log Language	976
19.6	SQL Security	976
19.6.1	Single node	976
19.6.2	Multinode	977
19.6.3	How to Configure Passwords to the SQL Database	978
19.7	SIP Attack Protection	978
<b>20</b>	<b>Networking OpenScape Business</b>	<b>980</b>
20.1	Network Plan	981
20.1.1	Homogeneous and Heterogeneous Networks	981
20.1.1.1	How to Display the Overview of all OpenScape Business Nodes	982
20.1.2	Single and Multi-Gateway	982
20.2	Network-wide Features	983
20.2.1	Network-wide Features of the UC Solutions	983
20.2.2	Network-wide Voice Features	986
20.3	Licensing an Internetwork	987
20.4	Networking Requirements	987
20.4.1	LAN Networking Requirements	988
20.4.2	Dial Plan in the Network	989
20.4.2.1	Dialing Public Phone Numbers in the Network	990
20.5	Path Optimization (Path Replacement)	991



20.5.1	How to Enable or Disable Path Optimization (Path Replacement)	991
20.6	Networking Scenarios	992
20.6.1	Dependencies and Restrictions	992
20.6.2	Networking Multiple OpenScope Business X Systems	993
20.6.2.1	How to Configure the Basic Installation for Node 1 (Master)	998
20.6.2.2	How to Configure Networking for Node 1 (Master)	999
20.6.2.3	How to Configure the Basic Installation for Node 2 (Slave)	999
20.6.2.4	How to Configure Networking for Node 2 (Slave)	1000
20.6.2.5	How to Verify the Networking Function for the Master	1001
20.6.2.6	How to Configure Routes and Routing Parameters (ISDN Trunk for the Master)	1001
20.6.2.7	How to Configure Routes and Routing Parameters (Trk. Grp. 16) (Master)	1002
20.6.2.8	How to Configure Least Cost Routing (LCR) for the Network (Master)	1003
20.6.2.9	How to Configure Routes and Routing Parameters (Slave)	1004
20.6.2.10	How to Configure Least Cost Routing (LCR) for the Network (Slave)	1004
20.6.3	Networking OpenScope Business X and OpenScope Business S (Single Gateway)	1006
20.6.3.1	How to Configure the Basic Installation for Node 1 (Master)	1011
20.6.3.2	How to Configure Networking for Node 1 (Master)	1012
20.6.3.3	How to Configure the Basic Installation for Node 2 (Slave)	1013
20.6.3.4	How to Configure Networking for Node 2 (Slave)	1014
20.6.3.5	How to Configure the Basic Installation for Node 3 (Slave)	1015
20.6.3.6	How to Verify the Networking Function for the Master	1016
20.6.3.7	Configure networking for node 3 (slave)	1017
20.6.3.8	How to Configure Least Cost Routing (LCR) for the Network (Node 3, Slave)	1017
20.6.3.9	How to Configure LCR for Networking (Node 2)	1019
20.6.3.10	How to Configure Routes and Routing Parameters (Node 1, Master)	1020
20.6.3.11	How to Configure Routes and Routing Parameters (Trk. Grp. 16, Node 1)	1021
20.6.3.12	How to Configure Least Cost Routing (LCR) for the Network (Node 1)	1022
20.6.4	Networking OpenScope Business X and OpenScope Business S (Multi-Gateway)	1024
20.6.4.1	How to Configure the Basic Installation for Node 4 (OpenScope Business S, Master)	1031
20.6.4.2	How to Configure the Networking for Node 4 (Master)	1032
20.6.4.3	How to Configure the Basic Installation for Node 1 (Slave)	1033
20.6.4.4	How to Configure Networking for Node 1 (Slave)	1034
20.6.4.5	How to Configure the Basic Installation for Node 2 (Slave)	1035
20.6.4.6	How to Configure Networking for Node 2 (Slave)	1036
20.6.4.7	How to Configure the Basic Installation for Node 3 (Slave)	1036
20.6.4.8	How to Configure Networking for Node 3 (Slave)	1037
20.6.4.9	How to Verify the Networking Function for the Master	1038
20.6.4.10	How to Configure a Multi-Gateway for Node 4 (Master)	1038
20.6.4.11	How to Configure Routes and Routing Parameters (Node 1, Slave)	1039
20.6.4.12	How to Configure Least Cost Routing (LCR) for the Network (Node 1, Slave)	1040
20.6.4.13	How to Configure Routes and Routing Parameters (Node 2, Slave)	1042
20.6.4.14	How to Configure Least Cost Routing (LCR) for the Network (Node 2, Slave)	1043
20.6.4.15	How to Configure Routes and Routing Parameters (Node 3, Slave)	1045
20.6.4.16	How to Configure Least Cost Routing (LCR) for the Network (Node 3, Slave)	1046
20.6.4.17	How to Configure Routes and Routing Parameters (Node 4, Master)	1048
20.6.4.18	How to Configure Least Cost Routing (LCR) for the Network (Node 4, Master)	1049
20.6.5	Networking OpenScope Business in Hosting Environments	1052
20.6.6	Networking OpenScope Business X and OpenScope Voice	1055
20.6.7	Connecting External Auxiliary Equipment to OpenScope Business via SIP Interconnection	1058
20.6.8	Open Numbering in OpenScope Business X Networks	1060
20.6.8.1	How to Configure Open Numbering	1061
20.6.9	Networking via ISDN	1062

## Contents

20.6.10	OpenScape Business internetwork with central ITSP trunk connection	1064
20.7	Central Intercept Position in the Internetwork (Not for U.S.)	1066
20.7.1	How to Configure a Central Intercept Position in the Multi-Gateway Internetwork	1067
20.8	Presence Manager	1069
20.9	Synchronization Status in the Internetwork	1069
20.9.1	Manual Synchronization in the Internetwork	1070
20.9.2	How to Start Synchronization Manually	1070
20.10	Survivability	1071
20.10.1	How to Configure Survivability	1072
20.11	Removing a Node from the Internetwork	1073
<b>21</b>	<b>Auxiliary Equipment</b>	<b>1074</b>
21.1	Analog Announcement Device	1074
21.1.1	How to Add an Analog Announcement Device	1075
21.1.2	How to Change the Announcement Delay Time	1076
21.2	Entrance Telephone and Door Opener	1076
21.2.1	DoorLine a/b T01-T04	1076
21.2.1.1	How to Configure the Station Port of the DoorLine a/b T01-T04	1077
21.2.1.2	How To Configure the Extension for the Doorline a/b T01-T04	1078
21.2.2	DoorCom Analog	1078
21.2.2.1	How to Configure the Station Port of the DoorCom Analog	1079
21.2.2.2	How to Configure DoorCom Analog Extensions	1079
21.2.3	Entrance Telephone with Amplifier (TFE-S)	1079
21.2.3.1	How to Configure the Entrance Telephone	1081
21.2.4	Loudspeakers	1081
21.2.4.1	How to Configure the Analog Station Interface for a Loudspeaker	1082
21.2.4.2	How to Configure the Analog Station Interface for Connecting an Amplifier to the TFE-S Module	1083
21.3	Relays	1083
21.3.1	How to Configure an Actuator	1085
21.4	Sensors	1086
21.5	OpenStage Gate View	1087
21.5.1	Legal Framework	1087
21.5.2	Components	1088
21.5.3	Function Overview	1089
21.5.4	Menu	1089
21.5.5	Initial Setup of OpenStage Gate View	1091
21.5.5.1	How to Start the Server Software for the First Time	1091
21.5.5.2	How to Change Your Administrator Password	1092
21.5.5.3	How to Add a Camera	1092
21.5.5.4	How to Add a Telephone	1093
21.5.6	OpenStage Gate View Video Recording	1093
21.5.6.1	How to Set up the Video Function at the Telephone	1094
21.5.6.2	How to Edit Existing Recordings	1095
21.5.7	OpenStage Gate View Entrance Telephone	1096
21.5.7.1	How to Set up the Entrance Telephone	1096
21.5.8	OpenStage Gate View User Management	1097
21.5.8.1	How to Add a User	1097
21.5.8.2	How to Edit User Data	1098
21.5.8.3	How to Delete a User	1098
21.5.9	OpenStage Gate View Server Administration	1099
21.5.9.1	How to Open the Administration Interface	1099

21.5.9.2	How to Display Software Information	1099
21.5.9.3	How to Delete Server Data	1099
21.5.9.4	How to Display and Save the Log File	1100
21.5.10	OpenStage Gate View Customizations	1100
21.5.10.1	How to Add a Camera manually	1101
21.5.10.2	How to Delete a Camera	1102
21.5.10.3	How to Add a Telephone Manually	1102
21.5.10.4	How to Delete a Telephone	1102
21.5.10.5	How to Deactivate the OpenStage Gate View Server	1103
<b>22</b>	<b>Application Connectivity</b>	<b>1104</b>
22.1	CSTA	1104
22.1.1	How to Change the Port Number for CSTA	1106
22.1.2	How to Enable or Disable the CMD for the Use of TAPI 120	1107
22.1.3	How to Enable or Disable the DSS Server for the Use of Network-Wide DSS Keys	1107
22.1.4	How to Activate or Deactivate the CSP	1108
22.1.5	How to Enable or Disable the Media Extension Bridge	1108
22.2	OpenScape Business TAPI 120/170	1109
22.2.1	OpenScape Business TAPI 120	1110
22.2.2	OpenScape Business TAPI 170	1114
22.3	Web Services Interface	1119
22.4	Open Directory Service	1120
22.4.1	How to Enable or Disable the Open Directory Service	1124
22.4.2	How to Restart the Open Directory Service	1124
22.4.3	How to Configure the Password for Access to the Open Directory Service	1125
22.4.4	How to Configure the ODBC to ODBC Bridge Server	1125
22.4.5	How to Add an External Data Source for the Open Directory Service	1127
22.4.6	How to Preview LDAP Search Results for the Open Directory Service	1130
22.4.7	How to Delete an External Data Source for the Open Directory Service	1130
22.5	XMPP	1130
22.5.1	How to Configure XMPP	1131
22.6	Application Launcher	1132
22.6.1	Prerequisites for Application Launcher	1132
22.6.2	Profile with Configuration Data for Application Launcher	1133
22.6.2.1	How to Provide a Profile with Configuration Data for Application Launcher	1134
22.7	Circuit	1134
22.7.1	How to Configure the Circuit Connectivity	1134
22.7.2	How to Manage Circuit Users	1135
22.7.2.1	How to Add Circuit Users	1136
22.7.2.2	How to Edit Circuit User Details	1136
<b>23</b>	<b>Accounting</b>	<b>1138</b>
23.1	Connection Data	1138
23.1.1	Connection Data Recording	1138
23.1.1.1	How to Enable or Disable Connection Data Recording	1139
23.1.1.2	How to Activate or Deactivate Logging of the Connection Duration	1139
23.1.1.3	How to Configure the Logging of Currency Amounts or Call Charge Units	1140
23.1.1.4	How to Configure Call Charge Factors, Currency and Computing Accuracy	1140
23.1.1.5	How to Activate or Deactivate the Logging of the Last Four Digits	1141
23.1.1.6	How to Enable or Disable Outgoing Call Logging without a Connection	1141
23.1.1.7	How to Enable or Disable the Logging of Incoming Calls	1142
23.1.1.8	How to Activate or Deactivate the Connection Log	1142
23.1.1.9	How to Activate or Deactivate MSN Logging	1143

## Contents

23.1.1.10	How to Activate or Deactivate the Decimal Format	1143
23.1.2	Account codes	1144
23.1.2.1	How to Configure Account Codes	1145
23.1.2.2	How to Configure an Account Code Checking Procedure	1145
23.1.2.3	How to Activate or Deactivate Number Redial with ACCT	1146
23.2	Displaying and Transmitting Connection Data	1146
23.2.1	Call-Charge Display with Currency (not for U.S.)	1146
23.2.1.1	How to Configure the Call-Charge Display with Currency	1147
23.2.2	Displaying the Connection Charges on the Phone	1147
23.2.3	Displaying the Connection Duration on the Phone	1148
23.2.3.1	How to Activate or Deactivate the Connection Duration Display	1148
23.2.4	Transmission of Connection Data	1148
23.2.4.1	How to Select the Format	1155
23.2.4.2	How to Enable or Disable Transmission of Connection Data via HTTPS	1155
23.3	Cost control	1156
23.3.1	Expensive Connection Route Advisory	1156
23.3.1.1	How to Configure an Expensive Connection Route Advisory	1156
23.3.2	Toll Fraud Monitoring	1157
23.3.2.1	How to Enable or Disable Toll Fraud Monitoring	1157
23.4	Accounting Tools	1157
23.4.1	Accounting Manager	1158
23.4.2	Teledata Office	1158
<b>24</b>	<b>Maintenance</b>	<b>1159</b>
24.1	Telephony Configuration	1159
24.1.1	Date and Time	1159
24.1.1.1	How to Configure the Date and Time Manually	1160
24.1.1.2	How to Set the Time Zone	1160
24.1.1.3	How to Configure the Date Format	1161
24.1.2	SNTP	1161
24.1.2.1	How to Obtain the Date and Time from an SNTP Server	1161
24.1.3	Telephone Logos	1162
24.1.3.1	How to Load a Phone Logo into the System	1162
24.1.3.2	How to Deploy a Phone Logo to System Telephones	1163
24.1.3.3	How to Delete a Phone Logo	1163
24.1.4	Customized Display	1163
24.1.4.1	How to Change the Customer-Specific Display (System Name)	1164
24.1.5	Multilingual Text Output	1164
24.1.6	Flexible Menus	1164
24.1.6.1	How to Edit the Flexible Menu	1165
24.1.7	Music on Hold	1165
24.1.7.1	How to Import Internal Music On Hold	1166
24.1.7.2	How to Configure the Music on Hold Functionality	1167
24.1.7.3	How to Change the Music on Hold Functionality for Each CON Group	1167
24.1.8	Announcements	1168
24.1.8.1	How to Configure Announcements (UC Smart)	1169
24.1.8.2	How to Configure Announcements (UC Suite)	1169
24.1.8.3	How to Configure the Announcement Player (only with UC Booster)	1170
24.1.9	User to User Signaling	1174
24.1.10	Voice Channel Signaling Security	1174
24.1.11	Time Parameters	1174
24.1.12	Controlling Centrex Features	1174

24.1.12.1	How to Enable or Disable the Control of Centrex Features	1174
24.2	Backup and Restore	1175
24.2.1	Backup Sets	1176
24.2.1.1	How to Display Backup Sets	1176
24.2.1.2	How to Delete Backup Sets	1177
24.2.2	Backup Media	1177
24.2.2.1	How to Add a Backup Medium	1178
24.2.2.2	How to Edit a Backup Medium	1179
24.2.2.3	How to Delete a Backup Medium	1180
24.2.3	Immediate Backup	1180
24.2.3.1	How to Save a Backup Set Immediately	1180
24.2.4	Scheduled Backup	1182
24.2.4.1	How to Save a Backup Set with a Scheduled Backup	1182
24.2.5	Restore	1183
24.2.5.1	How to Restore a Backup Set	1183
24.3	Updates	1184
24.3.1	Using a Local Web Server	1185
24.3.1.1	How to Configure Access to the Local Web Server	1186
24.3.2	Updating the Communication System	1187
24.3.2.1	How to Update the System via a Web Server	1188
24.3.2.2	How to Update the System using a USB Storage Device	1190
24.3.2.3	How to Update the System via File Upload	1191
24.3.2.4	How to Update the System via a USB Device without WBM Access	1192
24.3.3	Updating System Telephones	1193
24.3.3.1	How to Load the Phone Software into the System	1193
24.3.3.2	How to Deploy the Phone Software to System Telephones	1194
24.3.3.3	How to Delete the Phone Software	1194
24.3.3.4	How to Enable or Disable the Automatic Distribution of the Phone Software	1195
24.3.3.5	How to Convert an optiPoint WL2 professional from HFA to SIP	1196
24.3.3.6	How to Configure Automatic Re-flashing	1197
24.3.4	Software Status	1198
24.3.4.1	How to Check the Software Status	1198
24.4	Restart, Reload, Shutdown	1199
24.4.1	Restarting OpenScape Business	1199
24.4.1.1	How to Initiate a Restart of OpenScape Business	1200
24.4.2	Reloading OpenScape Business	1200
24.4.2.1	How to Initiate a Reload of OpenScape Business	1201
24.4.3	Shutting Down OpenScape Business X	1202
24.4.3.1	How to Shut Down OpenScape Business X	1202
24.4.4	PIN for the controlled shutdown of OpenScape Business X	1202
24.4.4.1	How to Configure a PIN for the Controlled Shutdown of OpenScape Business X	1203
24.4.5	Restarting (Rebooting) the UC Booster Card (Application Board OCAB)	1203
24.4.5.1	How to Initiate a Restart of the UC Booster Card (OCAB Application Board)	1203
24.4.6	Reloading the UC Booster Card (Application Board OCAB)	1204
24.4.6.1	How to Initiate a Reload of the UC Booster Card (OCAB Application Board)	1204
24.4.7	Restarting the UC Application	1205
24.4.7.1	How to Initiate a Restart of the UC Application	1205
24.5	Inventory Management	1206
24.5.1	System Status	1206
24.5.1.1	How to Check the Station Status	1207
24.5.1.2	How to Check the Status of the Connection Setup	1208
24.5.1.3	How to Check the ITSP Status	1209

## Contents

24.5.1.4	How to Check the VPN Status	1209
24.5.1.5	How to Display IP Addresses	1210
24.5.2	Inventory	1211
24.5.2.1	How to Check the Inventory of OpenScope Business X	1212
24.5.2.2	How to Check the Inventory of OpenScope Business S	1214
24.6	Automatic Actions	1215
24.6.1	Garbage Collection Automatic Action	1215
24.6.1.1	How to Edit the Garbage Collection Action	1215
24.6.1.2	How to Start the Garbage Collection Automatic Action (Activate)	1216
24.6.1.3	How to Stop the Garbage Collection Automatic Action (Deactivate)	1217
24.6.2	DLS Notification Automatic Action	1217
24.6.2.1	How to Edit the DLS Notification Automatic Action	1217
24.6.2.2	How to Start the DLS Notification Automatic Action (Activate)	1218
24.6.2.3	How to Stop the DLS Notification Automatic Action (Deactivate)	1219
24.6.3	Warning Mechanism for SDHC card lifetime	1219
24.6.3.1	How to Start the Warning Mechanism for SDHC lifetime Automatic Action	1220
24.6.3.2	How to replace an SDHC Card.	1221
24.7	Power Management	1223
24.7.1	How to Enable or Disable the Power Management	1223
24.7.2	How to Change the Ethernet Link Mode the LAN Interfaces	1224
24.8	Monitoring and Maintenance of OpenScope Business	1225
24.8.1	Checking the Network Connection of OpenScope Business X	1225
24.8.1.1	How to Ping	1225
24.8.1.2	How to Test the Trace Route	1226
24.8.2	SNMP (Simple Network Management Protocol)	1226
24.8.2.1	How to Display all Communities	1257
24.8.2.2	How to Add a Community	1257
24.8.2.3	How to Edit a Community	1258
24.8.2.4	How to Delete a Community	1258
24.8.2.5	How to Display Traps	1259
24.8.2.6	How to Display Details of a Trap	1259
24.8.3	Manual Actions	1260
24.8.3.1	How to Download Diagnostics Data / Diagnosis Logs	1262
24.8.4	Traces	1262
24.8.4.1	How to Download a System Trace Log File	1269
24.8.4.2	How to Delete a System Trace Log File	1270
24.8.4.3	How to Display all Trace Profiles	1270
24.8.4.4	How to Start or Stop a Trace Profile	1271
24.8.4.5	How to Display or Edit the Trace Format Configuration	1272
24.8.4.6	How to Display or Edit the Trace Output Interfaces	1272
24.8.4.7	How to Display or Edit Event Viewer and Customer Trace Logs	1273
24.8.4.8	How to Download or Open the Event Viewer Log / Customer Trace Log	1273
24.8.4.9	How to Clear the Event Viewer Log / Customer Trace Log	1274
24.8.4.10	How to Display M5T Trace Components	1274
24.8.4.11	How to Start or Stop an M5T Trace Component	1274
24.8.4.12	How to Edit M5T Trace Components	1275
24.8.4.13	How to Start or Stop the Secure Trace	1275
24.8.4.14	How to Check the Secure Trace Status	1276
24.8.4.15	How to Change the Secure Trace Password	1276
24.8.4.16	How to Import the Certificate for the Secure Trace from an X.509 File	1277
24.8.4.17	How to Display or Edit the H.323 Stack Trace Configuration	1277
24.8.4.18	How to Edit H.323 Modules	1277

24.8.4.19	How to Download or Open the H.323 Stack Trace Log	1278
24.8.4.20	How to Clear the H.323 Trace Log	1278
24.8.4.21	How to Edit the License Component Trace	1279
24.8.4.22	How to Display Details of a Trace Profile	1279
24.8.4.23	How to Stop all Trace Profiles	1280
24.8.4.24	How to Add a Trace Profile	1280
24.8.4.25	How to Display Trace Components	1280
24.8.4.26	How to Display Details of a Trace Component	1281
24.8.4.27	How to Start or Stop a Trace Component	1281
24.8.4.28	How to Stop all Trace Components	1282
24.8.4.29	How to Edit Trace Components	1282
24.8.5	TCP Dump	1282
24.8.5.1	How to Start a TCP Dump	1283
24.8.5.2	How to Stop a TCP Dump	1283
24.8.5.3	How to Delete a TCP Dump	1284
24.8.6	RPCAP daemon	1284
24.8.6.1	How to Enable the RPCAP Daemon	1284
24.8.6.2	How to Disable the RPCAP Daemon	1285
24.8.7	Events	1285
24.8.7.1	How to Edit Switch Event Logging via a LAN	1287
24.8.7.2	How to Download the Event Log File	1288
24.8.7.3	How to Delete an Event Log File	1288
24.8.7.4	How to Edit E-Mail Settings for Events	1289
24.8.7.5	How to Display the Event Reaction Table	1289
24.8.7.6	How to Edit the Reaction Settings for an Event	1289
24.8.7.7	How to Edit the Reaction Settings for Multiple Events	1290
24.8.7.8	How to Download or Open Diagnosis Logs	1291
24.8.7.9	How to Clear Diagnosis Logs	1292
24.8.7.10	How to Define Destinations for Alarm Signaling	1292
24.8.8	Configuration Data for Diagnostics	1292
24.8.8.1	How to Generate Configuration Data for Diagnostics	1293
24.8.9	Card Manager	1294
24.8.9.1	How to Use the Card Manager to Write the Communication Software on the SDHC Card	1295
24.9	Monitoring and Maintaining the UC Suite	1298
24.9.1	Logging	1298
24.9.1.1	How to Enable or Disable Recording of System Logs	1299
24.9.1.2	How to Enable or Disable the Recording of Client Logs on a System-wide Basis	1300
24.9.1.3	How to Enable or Disable the Recording of Client Logs on a Station-specific Basis	1300
24.9.1.4	How to Configure the Storage Path for Client Log Files	1301
24.9.1.5	How to Enable or Disable Central Storage of Client Logs on the Hard Disk of the Communication System	1302
24.9.1.6	How to Download the Client Logs of all Internal Stations	1302
24.9.2	Notification	1303
24.9.2.1	How to Configure E-mail Notifications of System Errors	1305
24.9.3	Maintenance	1306
24.9.3.1	How to Configure the Time for Maintenance	1307
24.9.3.2	How to Configure Retention Periods for Log Files	1308
24.9.3.3	How to Perform Immediate System Maintenance	1308
24.9.3.4	How to Configure the Retention Period for Contact Center Data	1309
24.10	Monitoring the UC Smart	1309
24.10.1	How to Query the Current Status of UC Smart	1309
24.11	Remote Services	1310

## Contents

24.11.1 RSP.servicelink	1310
24.11.1.1 How to Install, Configure and Register the RSP.servicelink Plugin	1313
24.11.1.2 How to Enable the RSP.servicelink Plugin	1314
24.11.1.3 How to Disable the RSP.servicelink Plugin	1315
24.11.1.4 How to Reset the RSP Service Plugin	1315
24.11.1.5 How to Configure a PIN for Activating and Deactivating the RSP.servicelink Plugin	1316
24.11.2 Remote Access	1316
24.11.2.1 How to Enable Remote Access via ISDN	1318
24.11.2.2 How to Configure PCs with Microsoft Windows Vista for Remote Access via ISDN	1318
24.11.2.3 How to Configure PCs with Microsoft Windows 7 for Remote Access via ISDN	1320
24.11.2.4 How to Enable Remote Access via Internet Access with a Fixed IP Address	1321
24.11.2.5 How to Enable Remote Access via Internet Access without a Fixed IP Address	1322
24.11.2.6 How to Disable Remote Access	1323
24.11.3 Online User	1323
24.11.3.1 How to Start the Online User	1324
<b>25 Migration</b>	<b>1325</b>
25.1 Migrating from HiPath 3000 to OpenScape Business V2	1325
25.1.1 License Migration	1327
25.1.2 Migration of a HiPath 3000 Standalone System	1330
25.1.2.1 How to Load the CDB from HiPath 3000	1331
25.1.2.2 How Read out the HG1500 Settings	1332
25.1.2.3 How to Convert the HiPath 3000 CDB	1332
25.1.2.4 How to Replace the HiPath 3300/3500 Hardware	1333
25.1.2.5 How to Replace the HiPath 3350/3550 Hardware	1334
25.1.2.6 How to Replace the Hardware for HiPath 3000	1336
25.1.2.7 How to Perform the Initial Installation	1337
25.1.2.8 How to Load the Converted CDB into the New System	1338
25.1.2.9 How to Generate a New License File	1338
25.1.2.10 How to Activate a License File Offline	1340
25.1.2.11 How to Assign Licenses	1340
25.1.2.12 How to Reset the LCR Entries	1340
25.1.3 Migration of a HiPath 3000 Standalone System with OpenScape Office V3 HX	1341
25.1.3.1 How to Convert an OpenScape Office V3 HX Backup Set	1343
25.1.4 Migrating a HiPath 3000 System to OpenScape Business UC Booster	1343
25.1.4.1 How to Activate the UC Booster Manually	1344
25.1.5 Migration of a HiPath 3000 Internetwork	1349
25.1.6 Migration of a HiPath 3000 Internetwork with HiPath 5000 RSM	1351
25.1.7 Changed Features and Interfaces	1353
25.1.8 Non-Supported Boards and Devices	1358
25.1.8.1 How to Convert an optiPoint WL2 professional from HFA to SIP	1363
25.2 Migrating from OpenScape Office V3 MX/LX to OpenScape Business V2	1364
25.3 Migrating from OpenScape Business V1 to V2	1365
25.3.1 Migrating an OpenScape Business V1 X System	1365
25.3.2 Migrating from OpenScape Business V1 S	1366
25.3.3 Migrating an OpenScape V1 UC Business Booster Server	1367
25.3.4 Migrating from OpenScape Business V1 Network to OpenScape Business V2 Network	1368
25.4 Migration within OpenScape V2 Business	1369
<b>26 Configuration Limits and Capacities</b>	<b>1371</b>
26.1 System-Specific Capacity Limits	1371
26.2 Software Capacities	1375



<b>27 Expert mode</b>	<b>1389</b>
27.1 Display Conventions for Parameter Descriptions	1389
<b>27.2 Maintenance</b>	<b>1390</b>
27.2.1 <b>Configuration</b>	<b>1390</b>
27.2.1.1 Configuration > Music on Hold (MoH) > Load to Gateway	1390
27.2.1.2 Configuration > Announcements > Load to Gateway	1391
27.2.1.3 Configuration > Port Configuration	1391
27.2.1.4 Configuration > SmartVM	1392
27.2.1.5 Configuration > SmartVM > Mailbox Operations	1392
27.2.1.6 Configuration > SmartVM > File Operations	1393
27.2.1.7 Configuration > Branding	1395
27.2.1.8 Configuration > IP Gateway Address	1395
27.2.2 <b>Software Image</b>	<b>1395</b>
27.2.2.1 Software Image > System Software > Update via Internet	1395
27.2.2.2 Software Image > System Software > Update via File Upload	1396
27.2.2.3 Software Image > System Software > Update via USB Stick	1397
27.2.2.4 Software Image > Phone Images > Load	1397
27.2.2.5 Software Image > Phone Images > Deploy	1398
27.2.2.6 Software Image > Phone Images > Deploy to device	1398
27.2.2.7 Software Image > Phone Logo Images > Load	1399
27.2.2.8 Software Image > Phone Logo Images > Deploy	1399
27.2.3 <b>Cordless</b>	<b>1400</b>
27.2.3.1 Cordless > Base Stations	1400
27.2.4 <b>Port/Board Status</b>	<b>1402</b>
27.2.4.1 Port/Board Status > Board Status	1402
27.2.4.2 Port / Board Status > Out of Service	1402
27.2.5 <b>Traces</b>	<b>1403</b>
27.2.5.1 Traces > Trace Format Configuration	1403
27.2.5.2 Traces > Trace Output Interfaces	1404
27.2.5.3 Traces > Trace Log	1405
27.2.5.4 Traces > Digital Loopback	1405
27.2.5.5 Traces > Customer Trace Log	1406
27.2.5.6 Traces > M5T Trace Components	1406
27.2.5.7 Traces > Secure Trace	1406
27.2.5.8 Traces > Secure Trace > Secure Trace Certificate	1407
27.2.5.9 Traces > Secure Trace > Secure Trace Settings	1407
27.2.5.10 Traces > Call Monitoring	1408
27.2.5.11 Traces > H.323 Stack Trace	1410
27.2.5.12 Traces > License Component	1411
27.2.5.13 Traces > Trace Profiles	1412
27.2.5.14 Traces > Trace Components	1412
27.2.5.15 Traces > TCP Dump	1413
27.2.5.16 Traces > rpcap Daemon	1413
27.2.5.17 Traces > Auto DSP Trace	1414
27.2.6 <b>Events</b>	<b>1414</b>
27.2.6.1 Events > Event Configuration	1414
27.2.6.2 Events > Event Log	1415
27.2.6.3 Events > E-mail	1415
27.2.6.4 Events > Reaction Table	1416
27.2.6.5 Events > Diagnosis Logs	1416
27.2.6.6 Events > Alarm Signaling	1417
27.2.7 <b>Restart / Reload</b>	<b>1417</b>

## Contents

27.2.7.1	Restart / Reload > Restart / Reload	1418
27.2.8	SNMP	1419
27.2.8.1	SNMP > Communities	1419
27.2.8.2	SNMP > Communities > Read Communities	1419
27.2.8.3	SNMP > Communities > Write Communities	1419
27.2.8.4	SNMP > Communities > Traps Communities	1420
27.2.8.5	SNMP > Traps	1420
27.2.9	Admin Log (also called Admin Protocol)	1421
27.2.9.1	Admin Protocol > Configuration	1421
27.2.9.2	Admin Protocol > Admin Log Data	1421
27.2.10	Actions	1421
27.2.10.1	Actions > Manual Actions > Diagnosis Logs	1421
27.2.10.2	Actions > Manual Actions > DLI Maintenance	1423
27.2.10.3	Actions > Automatic Actions > Garbage Collection	1423
27.2.10.4	Actions > Automatic Actions > DLS Notification	1424
27.2.11	Platform Diagnostics	1424
27.2.12	Application Diagnostics	1424
27.2.12.1	Application Diagnostics > Developer Settings > Trace Console Output	1425
27.2.12.2	Application Diagnostics > Developer Settings > Take Over Write Token	1425
27.2.12.3	Application Diagnostics > Mainboard	1425
27.2.12.4	Application Diagnostics > Developer Settings > SIP Provider Profiles	1425
27.2.13	IP Diagnostics	1425
27.2.13.1	IP Diagnostics > Mainboard > Address Resolution Protocol	1425
27.2.13.2	IP Diagnostics > Mainboard > ICMP Request > Ping	1426
27.2.13.3	IP Diagnostics > Mainboard > ICMP Request > Traceroute	1426
27.2.14	Online User	1427
27.2.14.1	Online Users	1427
27.3	Telephony	1427
27.3.1	Basic Settings	1427
27.3.1.1	Basic Settings > System > System Flags	1427
27.3.1.2	Basic Settings > System > Time Parameters	1434
27.3.1.3	Basic Settings > System > Display	1439
27.3.1.4	Basic Settings > System > DISA	1442
27.3.1.5	Basic Settings > System > Intercept/Attendant/Hotline	1443
27.3.1.6	Basic Settings > System > LDAP	1445
27.3.1.7	Basic Settings > System > Texts	1446
27.3.1.8	Basic Settings > System > Flexible Menus	1447
27.3.1.9	Basic Settings > System > Speed Dials	1447
27.3.1.10	Basic Settings > System > Service Codes	1448
27.3.1.11	Basic Settings > Gateway	1449
27.3.1.12	Basic Settings > DynDNS > DynDNS Service	1450
27.3.1.13	Basic Settings > DynDNS > Update Timer DNS Names	1451
27.3.1.14	Basic Settings > Quality of Service	1452
27.3.1.15	Basic Settings > Date and Time > Date and Time	1453
27.3.1.16	Basic Settings > Date and Time > Timezone Settings	1453
27.3.1.17	Basic Settings > Date and Time > SNTP Settings	1453
27.3.1.18	Basic Settings > Port Management	1454
27.3.1.19	Basic Settings > Call Charges > Call Charges - Output Format	1455
27.3.1.20	Basic Settings > Call Charges > Call Charges - Factors	1456
27.3.1.21	Basic Settings > Call Charges > Call Charges - Account Codes	1457
27.3.1.22	Basic Settings > Announcement Player for Voicemails/Announcements	1458
27.3.1.23	Basic Settings > Phone Parameter Deployment	1458

27.3.1.24	<b>Basic Settings &gt; Power Management</b> .....	1459
27.3.1.25	Basic setting > Mass Data .....	1460
27.3.2	<b>Security</b> .....	1461
27.3.2.1	<b>Security &gt; Application Firewall</b> .....	1461
27.3.2.2	<b>Security &gt; Deployment and Licensing Client (DLSC)</b> .....	1461
27.3.2.3	<b>Security &gt; Deployment and Licensing Client (DLSC) &gt; DLSC Client Certificate</b> .....	1462
27.3.2.4	<b>Security &gt; Deployment and Licensing Client (DLSC) &gt; DLSC CA Certificate</b> .....	1463
27.3.2.5	<b>Security &gt; Signaling and Payload Encryption</b> .....	1464
27.3.2.6	<b>Security &gt; Signaling Encryption/Payload Encryption &gt; SPE Certificate</b> .....	1465
27.3.2.7	<b>Security &gt; Signaling Encryption/Payload Encryption &gt; SPE CA Certificates</b> .....	1465
27.3.2.8	<b>Security &gt; VPN</b> .....	1466
27.3.2.9	<b>Security &gt; VPN &gt; Lightweight CA</b> .....	1466
27.3.2.10	<b>Security &gt; VPN &gt; Certificate Management</b> .....	1467
27.3.2.11	<b>Security &gt; VPN &gt; Certificate Management &gt; Trusted CA Certificates &gt; Active Certificates</b> 1468	
27.3.2.12	<b>Security &gt; VPN &gt; Certificate Management &gt; Trusted CA Certificates &gt; Configured Certificates</b> .....	1469
27.3.2.13	<b>Security &gt; VPN &gt; Peer Certificates</b> .....	1469
27.3.2.14	<b>Security &gt; VPN &gt; Services &gt; Active Services</b> .....	1471
27.3.2.15	<b>Security &gt; VPN &gt; Services &gt; Configured Services</b> .....	1471
27.3.2.16	<b>Security &gt; VPN &gt; Tunnels &gt; Active Tunnels</b> .....	1472
27.3.2.17	<b>Security &gt; VPN &gt; Tunnels &gt; Configured Tunnels</b> .....	1474
27.3.2.18	<b>Security &gt; VPN &gt; Rules &gt; Active Rules</b> .....	1477
27.3.2.19	<b>Security &gt; VPN &gt; Rules &gt; Configured Rules</b> .....	1479
27.3.2.20	<b>Security &gt; VPN &gt; Public Key Infrastructure (PKI)</b> .....	1480
27.3.2.21	<b>Security &gt; SSL &gt; Certificate Generation</b> .....	1480
27.3.2.22	<b>Security &gt; SSL &gt; Certificate Management</b> .....	1481
27.3.2.23	<b>Security &gt; SSL &gt; Certificate Management &gt; Server Certificates</b> .....	1482
27.3.2.24	<b>Security &gt; Web Security</b> .....	1483
27.3.2.25	<b>Security &gt; SQL Security</b> .....	1483
27.3.3	<b>Network Interfaces</b> .....	1483
27.3.3.1	<b>Network Interfaces &gt; Mainboard &gt; Host Name</b> .....	1484
27.3.3.2	<b>Network Interfaces &gt; Mainboard &gt; LAN 1 (WAN)</b> .....	1484
27.3.3.3	<b>Network Interfaces &gt; Mainboard &gt; LAN 2</b> .....	1488
27.3.3.4	<b>Network Interfaces &gt; Mainboard &gt; LAN 3 (Admin)</b> .....	1489
27.3.3.5	<b>Network Interfaces &gt; Mainboard &gt; FTP Server</b> .....	1489
27.3.3.6	<b>Network Interfaces &gt; Mainboard &gt; DHCP Mode</b> .....	1490
27.3.3.7	<b>Network Interfaces &gt; Mainboard &gt; DHCP Mode &gt; DHCP Server &gt; Global Parameters</b> ..	1490
27.3.3.8	<b>Network Interfaces &gt; Mainboard &gt; DHCP Mode &gt; DHCP Server &gt; IP Address Pools</b> ..	1491
27.3.3.9	<b>Network Interfaces &gt; Mainboard &gt; DHCP Mode &gt; DHCP Server &gt; Static IP Addresses</b> ..	1492
27.3.3.10	<b>Network Interfaces &gt; Mainboard &gt; DHCP Mode &gt; DHCP Server &gt; Last active Leases</b> ..	1493
27.3.3.11	<b>Network Interfaces &gt; Mainboard &gt; DHCP Mode &gt; DHCP Server &gt; All Leases</b> .....	1494
27.3.3.12	<b>Network Interfaces &gt; Application Board &gt; Host Name</b> .....	1494
27.3.3.13	<b>Network Interfaces &gt; Application Board &gt; LAN 1</b> .....	1495
27.3.3.14	<b>Network Interfaces &gt; Application Board &gt; LAN 2</b> .....	1495
27.3.4	<b>Routing</b> .....	1496
27.3.4.1	<b>Routing &gt; IP Routing &gt; Mainboard &gt; Static Routes</b> .....	1496
27.3.4.2	<b>Routing &gt; IP Routing &gt; Mainboard &gt; Default Router</b> .....	1497
27.3.4.3	<b>Routing &gt; IP Routing &gt; Mainboard &gt; DNS Server</b> .....	1497
27.3.4.4	<b>Routing &gt; IP Routing &gt; Application Board &gt; Static Routes</b> .....	1498
27.3.4.5	<b>Routing &gt; IP Routing &gt; Application Board &gt; Default Router</b> .....	1498
27.3.4.6	<b>Routing &gt; NAT</b> .....	1499

## Contents

27.3.4.7	Routing > PSTN	1500
27.3.4.8	Routing > PSTN > PPP Log	1500
27.3.4.9	Routing > PSTN > PSTN Partner	1500
27.3.5	LCR	1504
27.3.5.1	LCR > LCR flags	1504
27.3.5.2	LCR > Classes Of Service	1504
27.3.5.3	LCR > Dial Plan	1505
27.3.5.4	LCR > Routing Table	1505
27.3.5.5	LCR > Dial Rule	1507
27.3.5.6	LCR > Multisite	1508
27.3.6	Voice Gateway	1509
27.3.6.1	Voice Gateway > SIP Parameters	1509
27.3.6.2	Voice Gateway > ITSP Loc-ID Settings	1510
27.3.6.3	Voice Gateway > Codec Parameters	1511
27.3.6.4	Voice Gateway > Destination Codec Parameters	1513
27.3.6.5	Voice Gateway > Internet Telephony Service Provider	1514
27.3.6.6	Voice Gateway > Networking > Nodes	1518
27.3.6.7	Voice Gateway > Networking > Routing	1518
27.3.6.8	Voice Gateway > SIPQ-Interconnection	1518
27.3.6.9	Voice Gateway > Native SIP Server Trunk	1520
27.3.7	Station	1521
27.3.7.1	Station > Station > UP0 Stations	1521
27.3.7.2	Station > Station > IP Clients	1523
27.3.7.3	Station > Station > Analog Stations	1525
27.3.7.4	Station > Station > ISDN Stations	1526
27.3.7.5	Station > Station > DECT Stations > SLC Call number	1527
27.3.7.6	Station > Station > DECT Stations > DECT Stations	1528
27.3.7.7	Station > Station > IVM/EVM Ports > IVM	1529
27.3.7.8	Station > Station > IVM/EVM Ports > EVM	1530
27.3.7.9	Station > Station > Virtual Stations	1531
27.3.7.10	Station > Station > Station Parameters	1532
27.3.7.11	Station > Station > UC Applications	1541
27.3.7.12	Station > Station > Profiles/Templates	1542
27.3.7.13	Station > Station > DID Extensions	1544
27.3.7.14	Station > Station > Mobility Entry	1544
27.3.7.15	Station > Station > Circuit User	1546
27.3.7.16	Station > Station > SfB User	1546
27.3.7.17	Station > Station > Overview of Stations	1547
27.3.7.18	Station > Key Programming	1548
27.3.8	Cordless	1549
27.3.8.1	Cordless > System-wide	1549
27.3.8.2	Cordless > SLC	1551
27.3.8.3	Cordless > Multi-SLC	1552
27.3.8.4	Cordless > Base Stations	1553
27.3.9	Incoming calls	1553
27.3.9.1	Incoming Calls > Groups/Hunt groups	1553
27.3.9.2	Incoming Calls > Group Members	1556
27.3.9.3	Incoming Calls > Team/top	1557
27.3.9.4	Incoming Calls > Call Pickup	1560
27.3.9.5	Incoming Calls > UCD	1560
27.3.9.6	Incoming Calls > Call Forwarding	1563
27.3.10	Trunks/Routing	1565

27.3.10.1	Trunks/Routing > Trunks	1566
27.3.10.2	Trunks/Routing > Trunk group	1568
27.3.10.3	Trunks/Routing > QSIG Features	1575
27.3.10.4	Trunks/Routing > Assign MSN	1576
27.3.10.5	Trunks/Routing > ISDN Parameters	1576
27.3.11	Classes of Service	1577
27.3.11.1	Classes of Service > Stations	1577
27.3.11.2	Classes of Service > Day: Class of Service Groups	1577
27.3.11.3	Classes of Service > Night: Class of Service Groups	1578
27.3.11.4	Classes of Service > Allowed Lists	1579
27.3.11.5	Classes of Service > Denied Lists	1579
27.3.11.6	Classes of Service > Night Service	1580
27.3.11.7	Classes of Service > CON Group Assignment	1580
27.3.11.8	Classes of Service > CON Matrix	1581
27.3.11.9	Classes of Service > Autom. night service	1582
27.3.11.10	Classes of Service > Special Days	1582
27.3.12	Auxiliary Equipment	1583
27.3.12.1	Auxiliary Equipment > Announcements/Music On Hold > Announcements and Music on Hold	1583
27.3.12.2	Auxiliary Equipment > Entrance Telephone (Door Opener)	1584
27.3.12.3	Auxiliary Equipment > SmartVM	1585
27.3.13	Payload	1588
27.3.13.1	Payload > Devices	1588
27.3.13.2	Payload > Media Stream Control (MSC)	1589
27.3.13.3	Payload > HW Modules	1589
27.3.14	Statistics	1592
27.3.14.1	Statistics > Gateway Statics > Mainboard > Device Statistics	1592
27.3.14.2	Statistics > Gateway Statistics > Mainboard > MSC Statistics	1592
27.3.14.3	Statistics > SNMP Statistics	1592
27.3.14.4	Statistics > Telephony Statistics > System Texts	1593
27.3.14.5	Statistics > Telephony Statistics > UCD Agents	1593
27.3.14.6	Statistics > Telephony Statistics > Trunk Status	1593
27.3.14.7	Statistics > Telephony Statistics > Forwarding	1594
27.3.14.8	Statistics > Telephony Statistics > Stations	1594
27.4	Applications	1596
27.4.1	Application Selection	1596
27.4.1.1	Application Selection	1596
27.4.2	UC Smart	1597
27.4.2.1	UC Smart > Basic Settings	1597
27.4.2.2	UC Smart > User Management	1597
27.4.2.3	UC Smart: > Status	1598
27.4.3	OpenScope Business, UC Suite	1598
27.4.3.1	OpenScope Business, UC Suite	1599
27.4.3.2	OpenScope Business, UC Suite > User Directory	1599
27.4.3.3	OpenScope Business, UC Suite > Departments	1600
27.4.3.4	OpenScope Business, UC Suite > Groups	1601
27.4.3.5	OpenScope Business UC Suite > Templates	1601
27.4.3.6	OpenScope Business UC Suite > external directory	1602
27.4.3.7	OpenScope Business UC Suite > External Providers Config	1602
27.4.3.8	OpenScope Business UC Suite > Contact Center	1603
27.4.3.9	OpenScope Business UC Suite > Schedules	1610
27.4.3.10	OpenScope Business UC Suite > File Upload	1611

## Contents

27.4.3.11	OpenScape Business UC Suite > Conferencing	1612
27.4.3.12	OpenScape Business UC Suite > Site List	1612
27.4.3.13	OpenScape Business UC Suite > Server	1613
27.4.3.14	OpenScape Business, UC Suite > Profiles	1617
27.4.3.15	OpenScape Business, UC Suite > Fax Headlines	1619
27.4.3.16	OpenScape Business UC Suite > Skin Settings	1619
27.4.4	Web Services	1619
27.4.4.1	Web Services > XMPP	1619
27.4.4.2	Web Services > Web Collaboration	1620
27.4.5	Open Directory Service	1620
27.4.5.1	Open Directory Service > Basic Settings	1621
27.4.5.2	Open Directory Service > Data sources > OpenScape Business	1621
27.4.5.3	Open Directory Service > Data sources > LXV3	1621
27.4.5.4	Open Directory Service > Data sources > LXV3	1622
27.4.5.5	Open Directory Service > Maintenance	1622
27.4.5.6	OpenStage Gate View	1622
27.4.6	OpenStage Gate View	1622
27.4.7	Application Launcher	1622
27.4.7.1	Application Launcher	1623
27.4.8	IVM	1623
27.5	Middleware	1623
27.5.1	Announcement Player	1623
27.5.2	Csta Message Dispatcher (CMD)	1623
27.5.3	Csta Service Provider (CSP)	1624
27.5.4	DSS Server	1625
27.5.5	Media Extension Bridge (MEB)	1625
<b>28</b>	<b>Appendix</b>	<b>1626</b>
28.1	Supported Standards	1626
28.2	Euro-ISDN Features	1628
28.3	Used Ports	1630
28.4	Project Planning of DSP Channels for the OpenScape Business X3/X5/X8 Communication Systems	1632
<b>29</b>	<b>Glossary</b>	<b>1643</b>
29.1	Glossary	1643
<b>Index</b>		<b>1659</b>

# 1 Introduction and Important Notes

This introduction provides you with an overview of the documentation structure. The introduction should assist you in finding information on selected topics faster. Before you begin with the installation and startup of the communication system, make sure that you have carefully read the safety information and warnings as well as the important notes.

---

**INFO:** The safety information and requirements inform you about the safety and other requirements to be observed. The important notes contain information on the emergency behavior, the standards and guidelines for the installation, and the radio frequency interference of the communication system. In addition, you will also find details on and the proper disposal and recycling of the communication system here.

---

## 1.1 About this Documentation

This documentation describes the administration of OpenScape Business.™.

It includes the hardware models OpenScape Business X1, OpenScape Business X3, OpenScape Business X5 and OpenScape Business X8 as well as the software model OpenScape Business S (softswitch). The UC solution UC Smart is integrated in all OpenScape Business models. The UC solution UC Suite is offered for the hardware models with the optional UC Booster Card or UC Booster Server; in the case of the softswitch, a choice between UC Smart or UC Suite can be made.

---

**INFO:** The hardware models OpenScape Business X1/X3/X5/X8 (or OpenScape Business X for short) and the Softswitch OpenScape Business S are referred to in this documentation as communication systems.

UC Suite designates the advanced unified communications functions, including the Multimedia Contact Center.

---

The information in this document contains general descriptions of the technical possibilities, which may not always be available in individual cases. The desired features must be contractually specified for each case.

If a function is not available as described here, this may be due to the following reasons:

- The communication system does not have this feature.
- The required license is not available or activated.

## 1.1.1 Documentation and Target Groups

The documentation for OpenScape Business is intended for various target groups.

### **Sales and Project Planning**

The following documentation is intended for sales and project planning.

- **Feature Description**  
This documentation describes all the features. This document is an extract from the Administrator Documentation.

### **Installation and Service**

The following documentation is intended for service technicians.

- **OpenScape Business X1, Installation Guide**  
This document describes the installation of the hardware and the initial installation of OpenScape Business X1.
- **OpenScape Business X3/X5/X8, Installation Guide**  
This document describes the installation of the hardware and the initial installation of OpenScape Business X3/X5/X8.
- **OpenScape Business S, Installation Guide**  
This documentation describes the initial installation of the OpenScape Business S softswitch.
- **OpenScape Business X1, Service Documentation**  
This documentation describes the hardware of OpenScape Business X1.
- **OpenScape Business X3/X5/X8, Service Documentation**  
This documentation describes the hardware of OpenScape Business X3/X5/X8.

### **Administration**

The following documentation is intended for administrators.

- **Administrator Documentation**  
This documentation describes the configuration of features that are set up using the OpenScape Business Assistant (WBM). The Administrator documentation is available in the system as online help.
- **Configuration for Customer Administrators, Administrator Documentation**  
This documentation describes the configuration of features that can be set up using the OpenScape Business Assistant (WBM) with the **Basic** administrator profile.
- **Manager E, Administrator Documentation**  
This documentation describes the configuration of features that are set up using Manager E.

### **UC Clients / Telephone User Interfaces (TUI)**

The following documentation is intended for UC users.



- **myPortal Smart, User Guide**  
This documentation describes the configuration and operation of the UC client myPortal Smart.
- **myPortal for OpenStage, User Guide**  
This documentation describes the configuration and operation of myPortal for OpenStage.
- **myPortal for Desktop, User Guide**  
This documentation describes the installation, configuration and operation of the UC client myPortal for Desktop.
- **myPortal for Outlook, User Guide**  
This documentation describes the installation, configuration and operation of the UC client myPortal for Outlook.
- **Fax Printer, User Guide**  
This documentation describes the installation, configuration and operation of Fax Printer.
- **myPortal to go User Guide**  
This documentation describes the configuration and operation of the mobile UC client myPortal to go for smartphones and tablet PCs.
- **myAgent, User Guide**  
This documentation describes the installation, configuration and operation of the Contact Center client myAgent.
- **myReports, User Guide**  
This documentation describes the installation, configuration and operation of the Contact Center client myReports.
- **myAttendant, User Guide**  
This documentation describes the installation, configuration and operation of the attendant console myAttendant.
- **OpenScape Business Attendant, User Guide**  
This documentation describes the installation, configuration and operation of the attendant console OpenScape Business Attendant.
- **UC Smart Telephone User Interface (TUI), Quick Reference Guide**  
This documentation describes the voicemail phone menu of the UC solution UC Smart.
- **UC Suite Telephone User Interface (TUI), Quick Reference Guide**  
This documentation describes the voicemail phone menu of the UC solution UC Suite.

## 1.1.2 Structure of the Administrator Documentation

This section shows you how the content of the Administrator Documentation is structured. The hardware is described in the Service Documentation.

**Introduction and Important Notes**  
About this Documentation

<b>Section</b>	<b>Contents</b>
Introduction and Important Notes	Overview of the structure of this documentation and important information/safety information to be observed during installation and operation
System overview	Overview of the communication system for a quick start
Administration concept	Overview of administration programs and user roles in the WBM
Initial Installation of OpenScape Business X	Integration of OpenScape Business X3/X5/X8 in the customer LAN and basic configuration using wizards
Initial Installation of OpenScape Business S	Integration of OpenScape Business S in the customer LAN and basic configuration using wizards
Initial Installation of the OpenScape Business UC Booster	Integration of OpenScape UC Business Booster in the customer LAN and basic configuration using wizards
Licensing	Licensing procedures and licenses
Integration into the Internal Data Network (LAN)	LAN/WAN interface, name resolution, data routing, DLI and DLS
Connection to service provider	Internet access, IP telephony, trunk access
Station	Dial plan, IP stations, UP0 stations; DECT stations, ISDN and analog stations, virtual stations, users of UC clients, user profiles
UC Smart	Clients and functions of the unified communications solution UC Smart, including Smart Voicemail. Presence status, directories and journal, conferences, team functions, voicemails
UC Suite	Clients and functions of the UC Suite unified communications solution: Presence status and CallMe, directories and journal, conferences and web collaboration, voice and fax messages, instant messaging
Functions at the Telephone	Make calls, call signaling, calling line ID, functions during the call, optimizing communication
Working in a team (groups)	Call pickup group, group call, hunt group, team/top, MULAP, UCD
Call routing	Classes of service, toll restriction, tenant system, LCR, emergency calls
Attendants	AutoAttendants, OpenStage Attendant, PC-based attendants, intercept position
Multimedia Contact Center	Clients and functions of the Contact Center: agents, queues and schedules, VIP service, fallback, reports

Section	Contents
Mobility	myPortal to go, Mobility Entry, One Number Service, dual-mode telephony, IP mobility, Cordless/DECT
Security	Firewall, SPE, VPN, certificates
Networking OpenScape Business	Network plan, networking scenarios, central intercept position, survivability
Auxiliary Equipment	Announcement devices, entrance telephone and door opener, actuators and sensors, OpenStage Gate View
Application Connectivity	CSTA, TAPI, XMPP, Application Launcher
Accounting	Call detail recording, call charges and call duration, cost control
Maintenance	Backup and restore, update, restart, reload, shutdown, factory reset, inventory, actions, remote services
Migration	Upgrading HiPath 3000 to OpenScape Business
Configuration Limits and Capacities	Maximum values for the configuration limits and capacities of the different communication systems
Expert mode	Reference description of the windows/masks in Expert mode
Appendix	List of supported standards, the Euro-ISDN features and the IP protocols and port numbers used
Glossary	Brief descriptions of commonly used terms

### 1.1.3 Types of Topics

The types of topics include concepts and tasks:

Type of topic	Description
Concept	Explains the "What" and provides an overview of context and background information for specific features, etc.
Task (operating instructions)	Describes task-oriented application cases (i.e., the "How") step-by-step and assumes familiarity with the associated concepts.  Tasks can be identified by the title <b>How to</b> ....

## 1.1.4 Display Conventions

This documentation uses a variety of methods to present different types of information.

Type of information	Presentation	Example
User Interface Elements	Bold	Click <b>OK</b> .
Menu sequence	>	<b>File &gt; Exit</b>
Special emphasis	Bold	<b>Do not delete</b> Name.
Cross-reference text	Italics	You will find more information in the topic <i>Network</i> .
Output	Monospace font, e.g., Courier	Command not found.
Input	Monospace font, e.g., Courier	Enter LOCAL as the file name.
Key combination	Monospace font, e.g., Courier	<Ctrl>+<Alt>+<Esc>

## 1.2 Safety Information and Warnings

Safety information and warnings indicate situations that can result in death, injury, property damage, and/or data loss.

Work on the communication systems and devices should **only** be performed by personnel with proper qualifications.

Within the context of this safety information and these warnings, qualified personnel are people who are authorized to ground and label systems, devices, and trunks and put them into operation in compliance with the applicable safety regulations and standards.

Make sure you have read and noted the following safety information and warnings before installing and starting up the communication system:

Make sure you also read carefully and follow all safety information and warnings printed on the communication system and devices.

Familiarize yourself with emergency numbers.

### Types of Safety Information and Warnings

This documentation uses the following levels for the different types of safety information and warning:



**DANGER**

Indicates an immediately dangerous situation that will cause death or serious injuries.

---



**WARNING**

Indicates a universally dangerous situation that can cause death or serious injuries.

---



**CAUTION**

Indicates a dangerous situation that can cause injuries.

---

---

**NOTICE:** Indicates situations that can cause property damage and/or data loss.

---

**Additional symbols for specifying the source of danger more exactly**

The following symbol is generally not used in this documentation, but may appear on the devices or packaging.



ESD - electrostatically sensitive devices

---

**Related Topics**

- [Important Notes](#)

## 1.2.1 Warnings: Danger

"Danger" warnings indicate immediately dangerous situations that will cause death or serious injury.



**DANGER**

**Risk of electric shock through contact with live wires**

- Note: Voltages over 30 VAC (alternating current) or 60 VDC (direct current) are dangerous.
  - Only personnel with proper qualifications or qualified electricians should perform work on the low-voltage network (<1000 VAC), and all work must comply with the national/local requirements for electrical connections.
- 

## 1.2.2 Warnings: Warning

"Warnings" indicate universal dangerous situations that can cause death or serious injury.



**WARNING**

**Risk of electric shock through contact with live wires**

- Use separate ground wires to provide protective grounding for the OpenScape Business X3R, X3W, X5R and X5W communication systems. Before you start up the system and connect the phones and phone lines, connect the communication system with a permanent earthing conductor.
- Provide protective grounding for each system box of the OpenScape Business X8 communication system with a separate ground wire. Before you start up the system and connect the phones and phone lines, connect the communication system with a permanent earthing conductor.
- Only use systems, tools and equipment which are in perfect condition. Do not use equipment with visible damage.
- Replace any damaged safety equipment (covers, labels and ground wires) immediately.
- Replace the power cable immediately if it appears to be damaged.
- The communication systems and servers should only be operated with outlets that have connected ground contacts.
- During a thunderstorm, do not connect or disconnect lines and do not install or remove boards.
- Disconnect all power supply circuits if you do not require power for certain activities (for example, when changing cables). Disconnect all the communication system's power plugs and make sure that the communication system is not supplied by another power source (uninterrupted power supply unit, for instance).

Before starting any work, make sure that the communication system is de-energized. Never take it for granted that all circuits have reliably been

disconnected from the power supply when a fuse or a main switch has been switched off.

- Expect leakage current from the telecommunications network. Disconnect all telecommunication lines from the communication system before disconnecting the prescribed ground wire from the system.
- As long as the power supply is switched on, always observe the greatest caution when performing measurements on powered components and maintenance work on PC boards and covers.

Metallic surfaces such as mirrors are conductive. If you touch them, there is a risk of electric shocks or short circuits.

---

### 1.2.3 Warnings: Caution

"Caution" warnings indicate a dangerous situation that can result in injury.

---



#### **CAUTION**

##### **Risk of explosion caused by the incorrect replacement of batteries**

- Use only the approved battery packs.
  - The lithium battery should only be replaced with an identical battery or one recommended by the manufacturer.
- 



#### **CAUTION**

##### **Fire hazard**

- Only use communication lines with a conductor diameter of 0.4 mm (AWG 26) or more.
  - Do not store any documents or similar flammable items in a communication system.
- 



#### **CAUTION**

##### **Risk of injury resulting from laser radiation.**

Do not look directly into the beam of an optical interface.

---



---

## **CAUTION**

### **General risk of injury or accidents in the workplace**

- After completing test and maintenance work, make sure that all safety equipment is re-installed in the right place and that all covers and the housing are closed.
  - Install cables in such a way that they do not pose a risk of an accident (tripping), and cannot be damaged.
  - When working on an open communication system or server, make sure that it is never left unattended.
  - Use appropriate tools to lift heavy objects or loads.
  - Check your tools regularly. Only use intact tools.
  - When working on the systems, never wear loose clothing and always tie back long hair.
  - Do not wear jewelry, metal watchbands or clothes with metal ornaments or rivets.
  - Always wear the necessary eye protection whenever appropriate.
  - Always wear a hard hat where there is a risk of injury from falling objects.
  - Make sure that the work area is well lit and tidy.
- 

## **1.2.4 Warnings: Note**

"Note" warnings are used to indicate situations that could result in property damage and/or data loss.

The following contains important information on how to avoid property damage and/or data loss:

- Before placing the system into operation, check whether the nominal voltage of the mains power supply corresponds to the nominal voltage of the communication system or server (type plate).
- Follow these ESD measures to protect the electrostatically sensitive devices:
  - Always wear the antistatic wristband in the prescribed manner before performing any work on PC boards and modules.
  - Always place PC boards and modules on a grounded conductive base.
  - Make sure that the components of the communication system (e.g., the boards) are transported and shipped only in the appropriate packaging.
- Use only original accessories. Failure to comply with this safety information may damage the system equipment or violate safety and EMC regulations.
- Sudden changes in temperature can result in condensing humidity. If a communication system or server is transported from a cold environment to warmer areas, for example, this could result in the condensation of humidity. Wait until the communication system or server has adjusted to the ambient temperature and is completely dry before starting it up.



- Connect all cables only to the specified connection points.
- If no emergency backup power supply is available or if no switchover to emergency analog phones is possible in the event of a power failure, then no emergency calls can be made via the communication system following a power failure.
- Before starting wall mounting, check that the wall has sufficient load bearing capacity. Always use suitable installation and mounting materials to mount the communication systems and devices securely.
- Do not allow easily flammable materials to be stored in or near the room where the communication system is installed.

## 1.2.5 Country-specific Safety Information

Here, you will find information on the specific safety precautions to be observed when installing, starting up and operating the communication systems in certain countries.

### 1.2.5.1 Safety Information for Australia

The following safety precautions must always be observed when installing, starting up and operating the OpenScape Business X and OpenScape Business S communication systems and the OpenScape Business UC Booster Server (Application Server) in Australia:

- The OpenScape Business X and OpenScape Business S communication systems and the OpenScape Business UC Booster Server (Application Server) must be installed and serviced only by authorized personnel.
- OpenScape Business wall systems must be installed near the mains socket outlet that supplies power to the respective communication system. The wall socket shall be readily accessible. The integrity of the wall socket must be assured.
- The OpenScape Business X and OpenScape Business S communication systems and the OpenScape Business UC Booster Server (Application Server) must be configured to allow emergency calls (for example, 000) to be made at all times.
- If no emergency backup power supply is available or if no switchover to emergency analog phones (trunk failure transfer) is possible in the event of a power failure, then no emergency calls can be made via the communication system following a power failure).
- Music on Hold and paging devices must be connected to the communication system via a Line Isolation Unit approved by the Australian Communications Authority (ACA).

### 1.2.5.2 Safety Information for Brazil

The following safety precautions must always be observed when installing, starting up and operating the OpenScape Business X and OpenScape Business S communication systems and the OpenScape Business UC Booster Server (Application Server) in Brazil:

- The use of the outlet strip with overvoltage protection with part number C39334-Z7052-C33 is absolutely mandatory. The power supply of the OpenScape Business X and OpenScape Business S communication systems and the OpenScape Business UC Booster Server (Application Server) must be passed through an outlet strip with overvoltage protection.
- The use of shielded Ethernet cables for the LAN/WAN interfaces/ports of the OCCL, OCCM and OCCMR mainboards and the UC Booster Card OCAB (Application Board) is absolutely mandatory.

### 1.2.5.3 Safety Information for the U.S.

The following safety precautions must always be observed when installing, starting up and operating the OpenScape Business X and OpenScape Business S communication systems and the OpenScape Business UC Booster Server (Application Server) in the United States:

- **Disruption of the Network and T1**  
When communication systems are networked using T1 (1.544 Mbit/s), the telecommunications company (Federal Communications Commission (FCC)) must be notified whenever a communication system is removed from the grid. If any of the communication systems of Unify Software and Solutions GmbH & Co. KG described in this documentation disrupts the operation of the public telecommunications network, the telecommunications company is entitled to temporarily block access to the outside line. In general, the telecommunications company will inform you about this in advance. If this is not possible, you will receive notification at the earliest possible time. In this context, you will also be informed that you can lodge a complaint with the telecommunications company.
- **Telephone Company Facility Changes**  
The telecommunication company is entitled to adapt its own equipment, devices, operating procedures, and processes as necessary; Such modifications may impair the operation of your communication systems. Under normal circumstances, you should be notified in advance so you can maintain uninterrupted telephone service.
- **Nonlive Voice Equipment**  
Nonlive voice equipment, such as music-on-hold devices and voice recorders must be approved and released by Unify Software and Solutions GmbH & Co. KG and registered in accordance with the rules and regulations of Subpart C of the FCC Rules, Part 68.  
Unreleased devices for voice playback may only be connected through protective circuitry that is approved and released by Unify Software and Solutions GmbH & Co. KG and registered in accordance with the rules and regulations in Subpart C of the FCC Rules, Part 68.

- **Ringer Equivalence Number REN**  
The Ringer Equivalence Number (REN) is used to determine the number of devices that can be connected to a telephone line so that all the devices ring when that telephone number is called. In most areas, but not all, the sum of the RENs of all devices connected to a line should not exceed five. Contact the local telecommunication company to determine the maximum REN for your calling area.
- **New Local Area and CO Access Codes**  
Least Cost routing (LCR) must be configured to automatically recognize and take changes in local area codes and CO access codes into account. Otherwise, these codes will not be usable for calls when changes occur.
- **Hearing Aid Compatibility**  
Emergency phones and public phones (installed in common areas such as lobbies, hospital rooms, elevators, and hotel rooms, for example) must have handsets that are compatible with magnetically coupled hearing aids. Hearing-impaired individuals who are not in common areas must be provided with hearing-aid compatible handsets, if needed.  
All digital phones from Unify Software and Solutions GmbH & Co. KG manufactured after August 16, 1989, are hearing aid compatible and comply with FCC Rules, Part 68, Section 68.316.
- **Programmed Dialer features**  
When you program emergency numbers or make test calls to emergency numbers with programmed dialer features using products by Unify Software and Solutions GmbH & Co. KG, stay on the line and briefly explain to the dispatcher the reason for the call before hanging up. These activities should be performed during off-peak hours, such early morning or late evening.
- **Connecting Off-Premises Station Facilities**  
Customers who intend to connect off-premises station (OPS) facilities must inform the telecommunications company of the OPS class for which the equipment is registered and the connection desired.
- **Direct Inward Dialing Answer Supervision**  
Customers who operate any of the communication systems from Unify Software and Solutions GmbH & Co. KG described in this documentation without providing proper answer supervision are in violation of Part 68 of the FCC rules.  
Every communication system of Unify Software and Solutions GmbH & Co. KG described in this documentation returns proper answer supervision to the public switched telephone network (PSTN) when DID calls are:
  - answered by the called station.
  - answered by an attendant.
  - routed to an announcement administered by the customer.In addition, every communication system of Unify Software and Solutions GmbH & Co. KG described in this documentation also returns proper answer supervision on all DID calls forwarded to the PSTN. Permissible exceptions are when:
  - A call is not answered.
  - A busy tone is received.
  - A congestion tone (reorder tone) is received.

- **Equal Access Requirements**  
Call aggregators with an increased volume of traffic (such as hotels, hospitals, airports, schools, and so on) must provide end users equal access to the providers of their choice. The current equal access codes (also known as Carrier Access Codes, CACs) are 10xxx and 101xxxx, and 800/888 and 950, where xxx or xxxx represents the provider code.  
To select the provider of choice for a call, the user dials a provider-specific access code before dialing the called party number. Equal access is also obtained by dialing the 800/888 or 950 code of the provider of choice.  
Every communication system of Unify Software and Solutions GmbH & Co. KG described in this documentation is capable of providing user access to interstate providers through the use of equal access codes.  
Modifications by aggregators to alter these capabilities are a violation of the Telephone Operator Consumer Services Improvement Act of 1990 and Part 68 of the FCC Rules.

#### 1.2.5.4 Safety Information for Canada



---

#### **DANGER**

##### **Risk of electric shock through contact with live wires**

Only personnel with proper qualifications or qualified electricians should perform work on the low-voltage network (<1000 VAC) and all work must comply with the national/local requirements for electrical connections.

---

The following safety precautions must always be observed when installing, starting up and operating the OpenScape Business X and OpenScape Business S communication systems and the OpenScape Business UC Booster Server (Application Server) in Canada:

- **Ringer Equivalence Number REN**  
The Ringer Equivalence Number (REN) defines how many devices can be connected to a telephone line at the same time. The termination of an interface may consist of any combination of devices subject only to the requirement that the sum of the RENs of all the devices does not exceed five.
- **Restrictions for connecting devices**  
The Industry Canada label identifies certified equipment. This certification means that the equipment meets certain requirements with regard to the protection, operation and security of telecommunication networks. The requirements are documented in the Terminal Equipment Technical Requirements. Industry Canada provides no assurances that certified devices will always operate to the satisfaction of the customer.  
Before installing the equipment and components described in this documentation, it must be ensured that connections to the facilities of the local telecommunications company are permitted. The communication systems and servers must also be installed using an acceptable method of

connection. The customer should be aware that compliance with these conditions may not prevent degradation of performance in some situations. Repairs to certified equipment should be coordinated by a service technician designated by the manufacturer or supplier. Any repairs or alterations made by the user to any of the equipment or components described in this documentation, or any equipment malfunctions, may give the telecommunications company cause to request the user to disconnect the equipment.

To ensure their own safety, users must verify that the electrical ground connections of the power supply, telephone lines and the metallic water pipe system, if present, are interconnected. This precaution may be particularly important in rural areas.

## 1.3 Important Notes

The important notes inform you about emergency procedures and the proper disposal, recycling, intended use and operating conditions of the communication systems and servers. In addition, they also include details concerning the standards and guidelines for the installation, the radio interference characteristics of the communication systems, and data protection and data security.

---

### Related Topics

- [Safety Information and Warnings](#)

### 1.3.1 Emergencies

This section provides information on how to proceed in an emergency.

#### What To Do In An Emergency

- In the event of an accident, remain calm and controlled.
- Always switch off the power supply before you touch an accident victim.
- If you are not able to immediately switch off the power supply, only touch the victim with non-conductive materials (such as a wooden broom handle), and first of all try to isolate the victim from the power supply.

#### First Aid

- Be familiar with basic first aid procedures for electrical shock. A fundamental knowledge of the various resuscitation methods if the victim has stopped breathing or if the victim's heart is no longer beating, as well as first aid for treating burns, is absolutely necessary in such emergencies.
- If the victim is not breathing, immediately perform mouth-to-mouth or mouth-to-nose resuscitation.
- If you have appropriate training, immediately perform heart massage if the victim's heart is not beating.

### **Calling for Help**

Immediately call an ambulance or an emergency physician. Provide the following information in the following sequence:

- Where did the accident happen?
- What happened?
- How many people were injured?
- What type of injuries?
- Wait for questions.

### **Reporting Accidents**

- Immediately report all accidents, near accidents and potential sources of danger to your manager.
- Report all electrical shocks, no matter how small.

## **1.3.2 Proper Use**

The communication systems and servers may only be used as described in this documentation and only in conjunction with add-on devices and components recommended and approved by Unify Software and Solutions GmbH & Co. KG.

The prerequisites for the proper use of the communication systems and servers include proper transportation, storage, installation, startup, operation and maintenance of the system.

---

**INFO:** Clean the housing of the communication system and server only with a soft, slightly damp cloth. Do not use any abrasive cleaners or scouring pads.

---

## **1.3.3 Correct Disposal and Recycling**

Please read the information on the correct disposal and recycling of electrical and electronic equipment and old batteries.



All electrical and electronic products should be disposed of separately from the municipal waste stream via designated collection facilities appointed by the government or the local authorities. The correct disposal and separate collection of your old appliance will help prevent potential negative consequences for the environment and human health. It is a precondition for reuse and recycling of used electrical and electronic equipment. For more detailed information about disposal of your old appliance, please contact your city office, waste disposal service, the shop where you purchased the product or your sales representative. The statements quoted above are only fully valid for equipment which is installed and sold in the countries of the European Union and is covered by the directive 2002/96/EC. Countries outside the European Union may have other regulations regarding the disposal of electrical and electronic equipment.

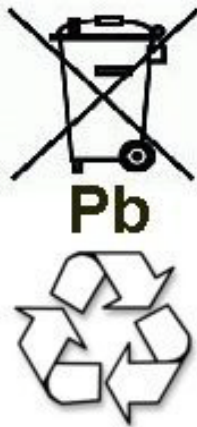

Old batteries that bear this logo are recyclable and must be included in the recycling process. Old batteries that are not recycled must be disposed of as hazardous waste in compliance with all regulations.

## 1.3.4 Installation Standards and Guidelines

This section provides information on the specifications you must comply with when connecting the communication systems and servers to the power supply circuit and when using shielded cabling for LAN and WAN connectors.

### 1.3.4.1 Connecting OpenScape Office X to the Power Supply Circuit

The OpenScape Business X communication systems have been approved for connection to TN-S power supply systems. They can also be connected to a TN-C-S power supply system in which the PEN conductor is divided into a ground wire and a neutral wire. TN-S and TN-C-S systems are defined in the IEC 364-3 standard.

Only qualified electricians should perform any work that may be required on the low-voltage network. These installation activities to connect the communication

systems must be performed in compliance with IEC 60364-1 and IEC 60364-4-41 or any corresponding legal norms or national regulations.

### **1.3.4.2 Connecting OpenScape Business S and OpenScape Business UC Booster Server to the Power Supply Circuit**

For information regarding the connection of OpenScape Business S and OpenScape Business UC Booster Server (Application Server) to the power supply circuit, please refer to the manufacturer's documentation for the server PC and the other components.

Only qualified electricians should perform any work that may be required on the low-voltage network. These installation activities to connect OpenScape Business S and the OpenScape Business UC Booster Server must be performed in compliance with IEC 60364-1 and IEC 60364-4-41 or any corresponding legal norms or national regulations (for example in the U.S. and in Canada).

### **1.3.4.3 Shielded Cabling for LAN and WAN Connections of OpenScape Business X**

Compliance with CE requirements on electromagnetic compatibility in the OpenScape Business X communication systems and their LAN and WAN connections is subject to the following conditions:

- The communication systems should only be operated using shielded connection cables. This means that a shielded Category 5 (CAT.5) cable with a length of at least 3 m should be used between the shielded LAN and WAN sockets of the communication systems and the building installation port or the external active component port. The cable shield must be grounded at the building installation end or the external active component end (connection to the building's potential equalization terminal).
- A shielded Category 5 (CAT.5) cable should also be used for shorter connections with external active components (LAN switch or similar). However, the active component must feature a shielded LAN connection with a grounded shield connection (connection to the building's potential equalization terminal).
- The shield properties of the cable components should at least satisfy the requirements of the European standard EN 50173-1<sup>\*)</sup> "Information technology - Generic cabling systems" (and all references specified).<sup>\*\*\*)</sup>
- Building installations that are fitted with shielded symmetrical copper cables throughout in accordance with the Class-D requirements<sup>\*\*)</sup> of EN 50173-1 satisfy the above condition.<sup>\*\*\*)</sup>

<sup>\*)</sup> The European standard EN 50173-1 is derived from the international standard ISO/IEC 11801.

<sup>\*\*)</sup> Class-D is reached, for instance, if Category-5 (CAT.5) components (cables, wall outlets, connection cables, etc.) are installed.



\*\*\*) UTP cables (U.S. standard EIA/TIA 568 T) are the most widely used cables on the North American market; this has the following implications for the LAN and WAN connections in communication systems: The systems may only be operated with shielded connection cables. This means that a shielded Category 5 (CAT.5) cable with a length of at least 3 m should be used between the shielded LAN and WAN sockets of the communication systems and the building installation port or the external active component port. The cable shield must be grounded at the building installation end or the external active component end (connection to the building's potential equalization terminal).

#### 1.3.4.4 Fire Safety Requirements

Fire safety requirements are defined on a country-specific basis in the building regulations. Please follow the valid regulations for your country.

To ensure the legal fire protection and EMC requirements, operate the OpenScape Business X communication systems only when closed. The system may only be opened temporarily for installation and maintenance purposes.

OpenScape Business system cables comply with the requirements of international norm IEC 60332-1 regarding flammability. The following norms contain similar requirements regarding cables:

<p>IEC 60332-1 Note: IEC 60332-1 is equivalent to test method UL VW-1</p>	<p>EN 50265-1 with EN 50265-2-1 Note: EN 50265-1 and -2-1 replace HD 405.1</p>	<p>VDE 0482 Parts 265-1 with VDE 0482 Parts 265-2-1 Note: VDE 0482 Parts 265-1 and -2-1 replace VDE 0472, Part 804, Test Method B</p>
---	--	---

The division responsible for project planning and service must check whether the IEC 60332-1 norm complies sufficiently with the relevant building regulation and any other applicable regulations.

#### 1.3.4.5 Lightning Protection Requirements

The protection of communication systems against high-energy surges requires a low-impedance ground connection in accordance with the specifications in the *OpenScape Business Installation Guide*.

---

**NOTICE:** Once a communication system has been grounded, check the low-impedance ground connection of the system using the ground conductor of the mains power supply circuit and the low-impedance connection (of the additional permanently-connected protective ground conductor) to the building's potential equalization bus.

---

---

**NOTICE:** Fire hazard due to surge voltage

Telecom lines which are over 500m in length or which must leave the building must be conducted through an additional external lightning protection.

Lightning protection of this kind is known as additional primary protection. The additional primary protection is guaranteed by the professional installation of ÜSAGs (surge arresters, gas filled) in the main distribution frame, the patch panel or at the entry point of the pipe in the building. A gas-filled surge arrester with 230 V nominal voltage is switched to ground from each wire that is to be protected.

Without this additional primary protection, lightning could irreparably damage the boards. This can cause the entire communication system to fail or result in components overheating (Fire hazard).

---

### 1.3.4.6 Markings for OpenScape Business X



The compliance of the equipment according to EU directives is confirmed by the CE mark. This Declaration of Conformity and, where applicable, other existing declarations of conformity as well as further information on regulations that restrict the usage of substances or affect the declaration of substances used in products can be found in the Unify Expert WIKI at <http://wiki.unify.com> under the section "Declarations of Conformity".

### 1.3.5 Notes on Electromagnetic and Radio Frequency Interference of OpenScape Business X

The OpenScape Business X communication systems are Class B devices in accordance with EN 55022.

### 1.3.6 Data Protection and Data Security

Please note the details below with respect to protecting data and ensuring privacy.

The communication systems and servers described in this documentation process and use personal data for purposes such as call detail recording, displays, and customer data acquisition.

In Germany, the processing and use of such data is subject to various regulations, including those of the Federal Data Protection Law (Bundesdatenschutzgesetz, BDSG). For other countries, please follow the appropriate national laws.

The aim of data protection is to protect the rights of individuals from being adversely affected by use of their personal data.

In addition, the aim of data protection is to prevent the misuse of data when it is processed and to ensure that one's own interests and the interests of other parties which need to be protected are not affected.

---

**INFO:** The customer is responsible for ensuring that the communication systems and servers are installed, operated and maintained in accordance with all applicable labor laws and regulations and all laws and regulations relating to data protection, privacy and safe labor environment.

---

Employees of Unify Software and Solutions GmbH & Co. KG are bound to safeguard trade secrets and personal data under the terms of the company's work rules.

In order to ensure that the statutory requirements are consistently met during service – whether on-site or remote – you should always observe the following rules. You will not only protect the interests of your and our customers, you will also avoid personal consequences.

A conscientious and responsible approach helps protect data and ensure privacy:

- Ensure that only authorized persons have access to customer data.
- Take full advantage of password assignment options; never give passwords to an unauthorized person orally or in writing.
- Ensure that no unauthorized person is able to process (store, modify, transmit, disable, delete) or use customer data in any way.
- Prevent unauthorized persons from gaining access to storage media such as backup CDs and DVDs or log printouts. This applies to service calls as well as to storage and transport.
- Ensure that storage media which are no longer required are completely destroyed. Ensure that no sensitive documents are left unprotected.
- Work closely with your customer contact; this promotes trust and reduces your workload.

## 1.3.7 Technical Regulations and Conformity of OpenScape Business X

Details on how the OpenScape Business X communication systems meet conformity requirements can be found here.

### 1.3.7.1 CE Conformity

CE certification is based on the R&TTE Directive 99/5/EEC.

	<b>Standards reference</b>
Safety	EN 60950-1
Electromagnetic Compatibility EMC	EN55022 (EMC Emission) EN55024 (EMC Immunity Residential)
Digital Enhanced Cordless Telecommunications (DECT)	ETS 300 329 (DECT Emission/Immunity) TBR 06, ETS 301489-1/6 (DECT Air Interface)

### 1.3.7.2 Conformity with US and Canadian Standards

	<b>Standards reference</b>
Safety USA	UL 60950-1
Safety Canada	CSA C22.2 No. 60950-1-03
EMC Emission	FCC Part 15 Subpart J Class B

#### **FCC Registration Number and Power Consumption**

A label on the rear of the housing of the communication systems identifies the FCC registration number, the ringer equivalence number (REN), and other information. Upon request, this information may be disclosed to the telecommunication company.

### 1.3.7.3 Conformity with International Standards

	<b>Standards reference</b>
Safety	IEC 60950-1

## 1.3.8 Operating Conditions

Note the environmental and mechanical conditions for operating the OpenScape Business X and OpenScape Business S communication systems and the OpenScape Business UC Booster Server (Application Server).

### 1.3.8.1 Operating Conditions for OpenScape Business X

The environmental and mechanical conditions for operating the OpenScape Business X communication systems are specified.

### Environmental Operating Conditions

Operating limits:

- Room temperature: + 5 to + 40 °C (41 to 104 °F)
- Absolute humidity: 1 to 25 g H<sub>2</sub>O/m<sup>3</sup>
- Relative humidity: 5 to 80%

Ventilation of the communication systems is by convection only. Forced ventilation is required for OpenScape Business X5W when using more than 32 a/b interfaces.

---

**NOTICE:** Damage caused by local temperature increases  
Avoid exposing the communication systems to direct sunlight and other sources of heat.

---

---

**NOTICE:** Damage caused by condensation due to humidity  
Avoid any condensation of humidity on or in the communication systems before or during operation under all circumstances.  
A communication system must be completely dry before you put it into service.

---

### Mechanical Operating Conditions

The communication systems are intended for stationary use.

## 1.3.8.2 Operating Conditions for OpenScape Business S and OpenScape Business UC Booster Server

For details on the environmental and mechanical conditions for operating OpenScape Business S and OpenScape Business UC Booster Server (Application Server), please also refer to the manufacturer documentation of the server PCs and the other components.

## 2 System Overview

OpenScape Business offers small and medium-sized businesses the answer to their individual and diverse communication needs in a unified, flexible and scalable solution. The OpenScape Business solution architecture can be deployed independently of the existing telephony infrastructure, regardless of whether traditional telephony, IP or DECT is involved. From powerful telephony to a comprehensive Unified Communications (UC) solution, OpenScape Business always provides the right solution.

### Flexible, scalable and powerful

OpenScape Business combines the best of HiPath 3000 and OpenScape Office in a new solution platform.

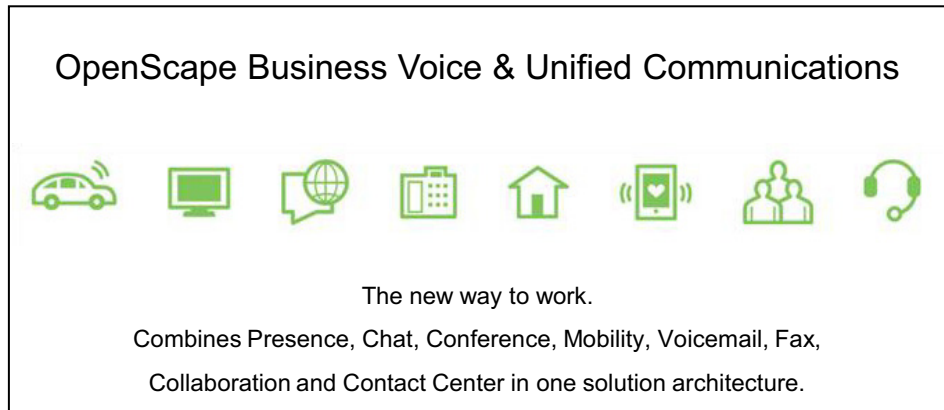

### 2.1 Highlights

OpenScape Business is the all-in-one solution for small and medium-sized enterprises and offers the following highlights.

#### Highlights

- Integrated voice services, presence management (presence status), drag and drop conferencing, visual voicemail (voicemail box), AutoAttendant, Multimedia Contact Center, IM (Instant Messaging), Mobility, directory access with database connection, fax, integration into business processes, and much more
- UC clients individually customized for the workplace and way of working
- Interface integration of OpenScape Web Collaboration
- The perfect solution for customers with one location or network-wide solution with multiple locations
- OpenScape Business offers a unified business solution architecture.
- Depending on the existing infrastructure, different OpenScape Business models are available for various configuration sizes. Alternatively, it is

possible to run the OpenScape Business software on a standard server (Softswitch) - also in fully virtualized environments, of course.

- The UC solution UC Smart is already provided on the mainboard. The additive UC solution UC Suite supports a larger number of UC users and offers an expanded scope of UC features. A UC Booster Card or a UC Booster Server is required for this.
- All communication interfaces are already available for diverse and heterogeneous requirements: IP, digital, analog and DECT, as well as all common trunk interfaces for voice communication

## 2.2 Unified Communications

Unified Communications (UC) is a technology that improves communication in enterprises by integrating various communication media in a unified application environment. Unified Communications simplify business processes in enterprises through an integrated presence management (e.g., calls are routed automatically to the mobile phone when the user is out of the office). Several other features such as dial-in conferencing, personal voicemail (voicemail box), personal fax box, Instant Messaging (IM), use of the mobile phone as an extension of the communication system, Contact Center, video and web collaboration, etc., are also combined in this unified solution.

With the flexible unified communications approach of OpenScape Business, a number of different UC solutions are offered, depending on the requirements at the workplace and the existing infrastructure. For the UC solution, you can choose between UC Smart and UC Suite (both cannot be used simultaneously).

The UC Smart solution already integrated in OpenScape Business can be migrated to the advanced UC Suite solution at any time via an upgrade license. Depending on the number of UC subscribers, OpenScape Business must then only be expanded with the internal board "UC Booster Card" or the external Linux server "UC Booster Server". As a pure softswitch, OpenScape Business S is available as a server solution with the optional UC Smart or UC Suite.

### 2.2.1 UC Features (Overview)

Depending on the selected UC solution (UC Smart or UC Suite) different UC functions are available to you.

The following tables are intended to help you choose the best UC solution for your requirements. Detailed functional constraints can be found in the relevant sections (UC Smart, UC Suite, Attendants) of the Feature Description and Administrator Documentation.

**System Overview**  
Unified Communications

UC feature	UC Smart		UC Suite		Notes
	myPortal Smart	myPortal to go	myPortal for Desktop/ Outlook	myPortal to go	
<b>Presence Status</b>					
Presence status (presence management)	x	x	x	x	
Change presence status via the Client	x	x	x	x	
Change presence status via the TUI	-	-	x	-	
Status-based call forwarding	x	x	x	Via destinations defined in myPortal	With UC Smart, any number can be selected as the destination. With UC Suite, only a number from the preselection can be selected.
Status display in favorites	x	x	x	x	
Status display in directories	x	x	x	x	
Status display in the Journal	-	-	x	-	
Enable CallMe service	-	-	x	x	
Calendar integration (Outlook)	-	-	x	-	
Calendar integration (iCal) (only with myPortal for Desktop)	-	-	x	-	
<b>Favorites</b>					
Display call status	x	x	x	x	
Create groups	x	x	x	-	
Compact display of favorites	x	-	x	-	
<b>Directories</b>					
Personal directory	x	x	x	x	
Internal directory	x	x	x	x	
External directory	-	-	x	x	
Search in directories	x	x	x	x	In myPortal Smart, also a quick search
Access to speed-dial destinations defined in the system (SSD)	x	x	-	x	
Import / Manage personal contacts (CSV / XML)	x	-	x	-	
Access to Outlook Contacts	x	-	x	-	
Import of personal contacts (Mac OS) (myPortal for Desktop)	-	-	x	-	
Integration of external directory server via LDAP	-	-	x	-	



UC feature	UC Smart		UC Suite		Notes
	myPortal Smart	myPortal to go	myPortal for Desktop/ Outlook	myPortal to go	
<b>Journal</b>					
All calls	x	x	x	x	
Open calls	-	-	x	-	
Missed calls	x	x	x	x	
Answered calls	x	x	x	x	
Scheduled calls	-	-	x	-	
Voicemail	-	x	x	x	
Fax journal	-	-	x	-	
<b>Calls</b>					
Manual dialing	x	x	x	x	
Desktop dialer (click to call)	x	-	x	-	
Forwarding	x	x	x	x	
Place call on hold	x	x	x	x	
Record calls (voice recording)	-	-	x	-	
Send email	x	x	x	x	
Send SMS	-	x	-	x	
Start chat	x	-	x	-	
Popups	x	-	x	-	
<b>Conferences</b>					
AdHoc conference	x	x	x	x	
Scheduled conferences	-	-	x	-	
Permanent and open conferences (drag & drop conference)	x	-	x	-	
Web collaboration integration	x	-	x		
<b>Voice and fax messages</b>					
Voicemail box (visual voicemail)	x	x	x	x	Voicemail functionality for subscribers (IP, TDM)
Playback through phone	x	x	x	x	
Playback through PC sound card	-	-	x	-	
How to Send a Voice Message as an Email	x	x	x	-	
Fax	-	-	x	-	
<b>Instant messaging</b>					
Instant messaging (chat)	x	-	x	-	

1 myPortal to go also allows access to the local smartphone contacts.

**Contact Center**

UC feature	UC Smart	UC Suite		Notes
		myAgent	myReports	
Agents, queues and schedules	-	x	-	
Fax and email	-	x	-	
Predefined reports/report templates	-	x	x	
Scheduled creation of reports	-	-	x	

Optionally, the connection of OpenScope Contact Center is possible.

**Attendants (Attendant Consoles)**

UC feature	UC Smart	UC Suite	Notes
	Business Attendant	myAttendant	
Display of waiting calls with call type, name and phone	x	x	
Display connection status	x	x	
Fast switching of calls	x	x	
Speed-dialing via BLFs and user buttons. Individual configuration of the busy lamp fields and user buttons with call number or name	x	x	
View presence status of other subscribers	x	x	With OpenStage Business Attendant, presence requires the UC Booster Card/Server or Business S
Change presence status of other subscribers	x	x	
Personal directory	-	x	
Internal directory	x	x	
External directory	x	x	
Outlook Contacts	x	x	
LDAP access	x	x	
Journal	-	x	
AdHoc conference	x	x	
Scheduled, permanent and open conferences (drag & drop conference)	-	x	

UC feature	UC Smart	UC Suite	Notes
	Business Attendant	myAttendant	
Message Center	-	x	All voicemails, faxes, instant messages as well as SMS messages and emails are recorded and managed via the Message Center
Access to voicemail and fax messages of other subscribers	-	x	Must be released by each respective subscriber
Instant messaging (chat)	-	x	
Night service	x	x	

The recommended Attendant client for UC Suite is myAttendant. However, OpenScope Business Attendant can also be used with UC Suite.

### Voicemail & Company AutoAttendant

UC feature	UC Smart	UC Suite	Note
Basic functionality of UC Smart Voicemail & Company AutoAttendant	x	-	
Basic functionality of UC Suite Voicemail & Company AutoAttendant	-	x	Requires UC Booster Card/ Server or Business S
<b>UC Features</b>			
Graphical operation of voicemail for subscribers (web interface or client interface)	x	x	
Voicemail prompts for presence function	x	x	Different announcements, depending on the set UC presence
Personal rules for greetings per mailbox	-	x	The subscriber defines detailed rules for the selection of his or her personal greetings
Voicemail to Email	x	x	Voicemail is attached to email as a wave file
<b>AutoAttendant functions</b>			
Attendant mailboxes (Basic AutoAttendants)	100	20	
Company AutoAttendant	x	x	Central attendant console and centralized voicemail with alternative greetings for each extension
Announcement prior to answer / Parallel signaling	x	x	Announcement to the caller while the subscriber is being called  For UC Suite, this is only possible in conjunction with the Contact Center

**System Overview**  
Unified Communications

UC feature	UC Smart	UC Suite	Note
Dial-in destinations for 4 day sections / Calendar for AutoAttendant	x	x	Variable automated Attendant for different times of the day  Calendar function possibly with UC Smart via the automatic night service
Central calendar for mailbox	x	x	Announcements and call handling for company-wide events such as holidays, company holidays, etc.
Custom profiles for mailbox and personal AutoAttendant	-	x	Presence-based call handling that can be individually set per subscriber
Schedules	Day and Night service	Schedule with rules (Call Control Vector, CCV)	
Templates	1 AutoAttendant configured by default	5 customizable templates	
Graphical rule editor (CCV editor)	-	x	
Concatenation of mailboxes / Multi-step AutoAttendant	x	-	The call is forwarded from one concatenated mailbox to the next, and each time the respective announcement is played
Dial by Name	-	x	
Dial by Extension	x	x	
<b>Voicemail features</b>			
Personalized greetings per mailbox	4	10	Save and set various announcements
Forwarding of voice messages	-	x	Forward message to another subscriber/mailboxes
Callback from the voicemail box	x	x	Callback to the caller of the message can be activated
Notification call	-	x	When a message arrives, a call is made to an external destination, e.g., a mobile phone
Representative function	-	x	Forward caller to representative with personal announcement
Caller-based voicemail / CLI routing	-	x	Call number-based handling, e.g., a greeting in the language of the caller
Central group mailbox	x	x	With announcements for departments / groups

UC feature	UC Smart	UC Suite	Note
Live Recording	-	x	Recording of conversations with security functions  In OpenScape Business S in which live recording from UC is used, G.729A is not considered.
Save messages	-	x	Subscribers can save individual voicemail messages for themselves
Automatic deletion of messages	x	x	After a retention period, messages are deleted to free storage space
Switch voicemail box language on subscriber-specific basis	-	x	Selection of automatic announcements in individual language

## 2.2.2 User Access to UC Features (UC Clients)

Access to the UC features occurs via UC clients. The presence status (UC Suite) and voicemail (UC Smart and UC Suite) can also be accessed through the telephone user interface (TUI).

UC clients are offered for the major operating systems. Please also note the requirements of the clients in the respective release notes.

### Communication Clients (Desktop and Groupware Clients)

Client	Recommended for		Description
	UC Smart	UC Suite	
myPortal Smart	x	-	UC Desktop Client for Microsoft Windows and Apple Mac
myPortal for Desktop	-	x	Advanced UC Desktop Client for Microsoft Windows and Apple Mac
myPortal for Outlook	-	x	UC Groupware Client for Microsoft Outlook Integration
myPortal for OpenStage	x	x	Presence and voicemail control for UC Suite  Presence control for UC Smart  For OpenStage 60 HFA and OpenScape Desk Phone IP 55G HFA telephones
OpenScape Desk Phone CP 400/600 HFA(integrated Client to phone software)	x	x	Presence control and phonebook access for UC Suite and UC Smart

**Figure:** myPortal Smart, myPortal for Desktop and myPortal for Outlook

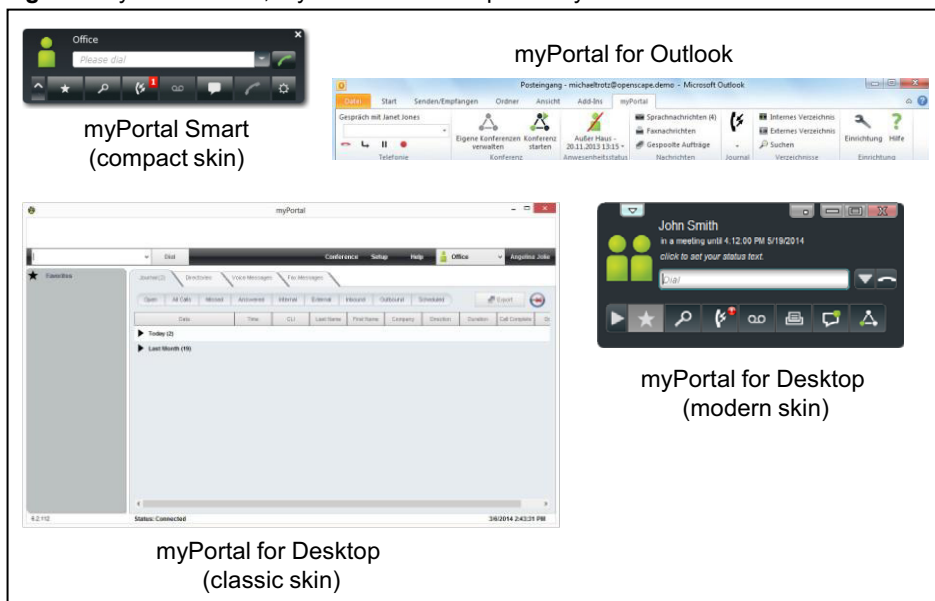

**Mobility Clients**

Client	Recommended for		Description
	UC Smart	UC Suite	
myPortal to go	x	x	Mobile app for smartphones and tablet PCs  myPortal to go is available for UC Smart and UC Suite with slightly different features

**Figure: myPortal to go**



**Contact Center Clients**

Client	Recommended for		Description
	UC Smart	UC Suite	
myAgent	-	x	Contact Center Client
myReports	-	x	Reports/Reporting interface for Contact Center  myReports can be also be used for system statistics independently of the Contact Center

**Figure: myAgent**

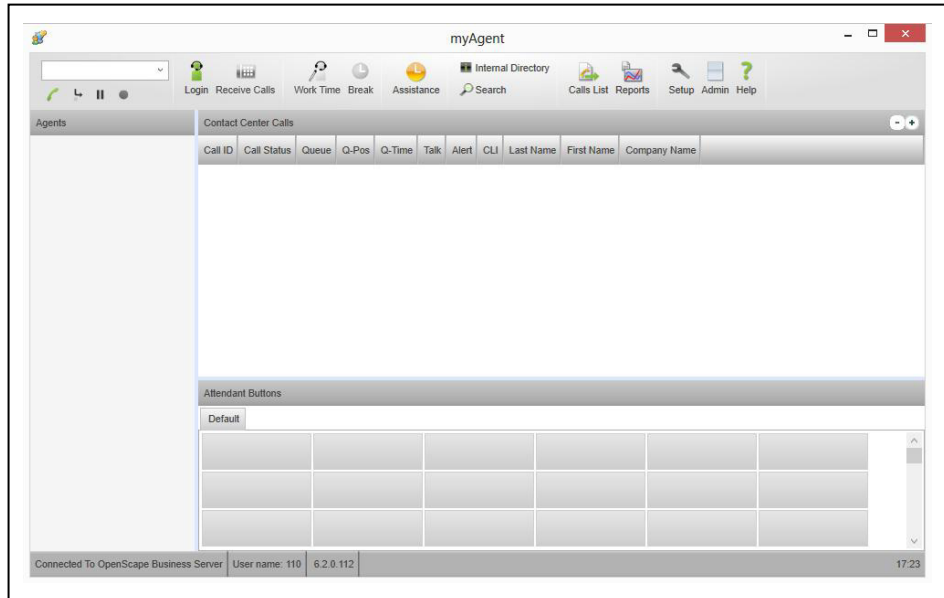

**Attendants/Attendant Consoles**

Client	Recommended for		Description
	UC Smart	UC Suite	
OpenScape Business Attendant	x	-	UC Attendant Console including presence
myAttendant	-	x	Advanced UC Attendant Console for UC Suite

**Figure: myAttendant**

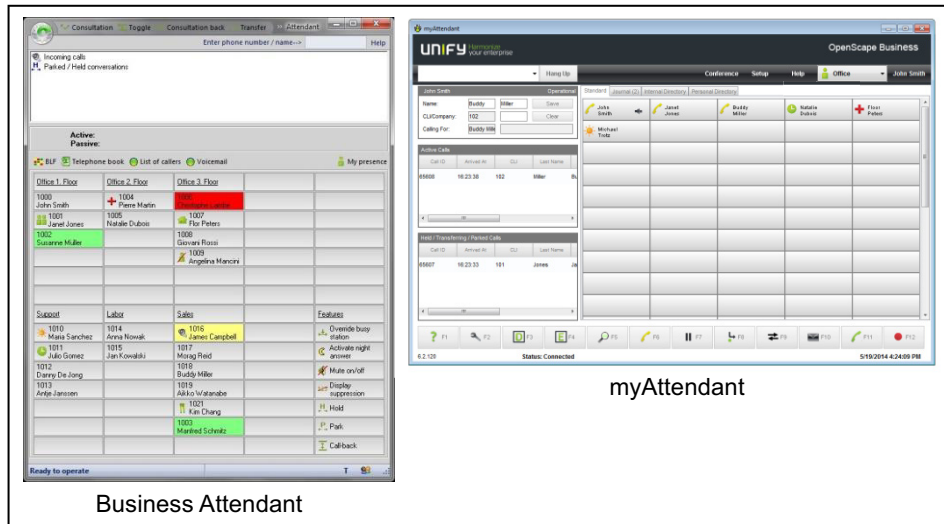

**myAttendant**

**Business Attendant**



## 2.2.3 Integration in Business Applications

OpenScape Business can be integrated into existing IT infrastructures and business applications.

### Applications

- Application Launcher for active interaction with CRM/ERP applications
- Accounting software for evaluating call charges

### Integrated Services

- Directory services for information about callers and searching in internal and external directories
- Presence management and instant messaging (IM) to social media networks using XMPP
- Web services for interactions with web-based applications on mobile phones and tablet PCs, for example

### CTI Middleware

- First and third-party TAPI Service Provider for call control from CTI and CRM/ERP applications

### Interfaces and Protocols

- CSTA for monitoring and controlling different applications
- SIP for connecting to SIP trunking based applications
- LDAP for connecting to external directories or from external LDAP clients
- HTTP and HTTPS for accessing UC functions of the integrated web server
- TCP/IP as the basic protocol for all Ethernet connections
- SQL connector for connecting SQL databases (Microsoft SQL Server, PostgreSQL, Sybase SQL Server)
- LDAP connector for external LDAP servers such as Active Directory, for example

## 2.3 OpenScape Business Models

Different models are available for the use of telephony and UC functionality. You can choose between hardware models and pure software models that operate on standard servers or in a virtual environment with VMware vSphere.

The UC functionality for UC Smart is already integrated in OpenScape Business X. UC Suite additionally requires either the internally pluggable board "UC Booster Card" or the external Linux server "UC Booster Server". The OpenScape Business S softswitch optionally supports either UC Smart or UC Suite.

## 2.3.1 Expansion Levels Available through Sales

The OpenScope Business models have different expansion levels.

	X1	X3R/X3W	X5R/X5W	X8	S
<b>Connection to Service Provider</b>					
ITSP channels (SIP providers)	30	60	60	60	180
Max. number of active SIP providers	8	8	8	8	8
ISDN S <sub>0</sub> (BRI)	4	20	52	128	-
	via mainboard	X3R: 2* STLSX4R X3W: 2* STLSX4	X5R: 6* STLSX4R X5W: 6* STLSX4	SW limit, i.e., regardless of the number of STDM3 boards	
ISDN S <sub>2M</sub> (PRI)	-	-	30	180	-
			1* TS2	3* DIUT2	
Max. number of trunk channels (ITSP, SIP-Q, Native SIP, TDM trunks, MEB)	250	250	250	250	250
<b>Stations</b>					
ISDN	4	20	52	128	-
	via mainboard	X3R: 2* STLSX4R X3W: 2* STLSX4	X5R: 6* STLSX4R X5W: 6* STLSX4	8* STMD3	
Analog	4	20	52/68	384	-
	via mainboard	X3R: 2* SLAV8R X3W: 1* SLAV16	X5R: 6* SLAV8R X5W: 4* SLAV16	16* SLMA	
Digital (U <sub>P0/E</sub> )	8	24	56	384	-
	via mainboard	2* SLU8(R)	6* SLU8(R)	16* SLMO2	
IP stations	20 <sup>1</sup>	500	500	500	2000 (max. 500 SIP stations)
Cordless/DECT (CMI)	16	32	32/64	250	-
	1-7 base stations via Mainboard	1-7 base stations via mainboard + 8-15 via SLUN	X5R: 1-7 base stations via mainboard + 8-15 via SLUN  X5W: 64 with 1* SLC16N	4* SLCN	
Max. number of stations	30 <sup>1</sup>	500	500	500	2000
<b>Unified Communications (UC Smart)</b>					
UC Smart VoiceMail (Smart VM)	30	500/320 <sup>2</sup>	500/320 <sup>2</sup>	500/320 <sup>2</sup>	1500

	X1	X3R/X3W	X5R/X5W	X8	S
Maximum number of simultaneously active UC Smart clients  (Sum of myPortal Smart, myPortal to go, myPortal for OpenStage, Application Launcher, OpenScape Business Attendant, OpenScape Business BLF and 3rd Party WSI Clients)	30	250/50 <sup>2</sup>	250/50 <sup>2</sup>	250/50 <sup>2</sup>	250
myPortal Smart	30	250/50 <sup>2</sup>	250/50 <sup>2</sup>	250/50 <sup>2</sup>	250
OpenScape Business Attendant	8	8	8	8	8
OpenScape Business BLF	30	250	250	250	250
	Max 350 BLF keys	Max 350 BLF keys	Max 350 BLF keys	Max 350 BLF keys	Max 350 BLF keys
Max. number of the mobile stations	30	250/50 <sup>2</sup>	250/50 <sup>2</sup>	250/50 <sup>2</sup>	250
Number of Mobility Entry User stations	30	150	150	150	250
myPortal to go	30	250/50 <sup>2</sup>	250/50 <sup>2</sup>	250/50 <sup>2</sup>	250
Maximum number of channels for UC conferences	30	30	30	30	60
<b>Unified Communications (UC Suite)</b>					
UC Suite VoiceMail	-	500	500	500	1500
Maximum number of simultaneously active UC Suite clients  (Sum of myPortal for Desktop, myPortal for Outlook, myAttendant, myAgent)	-	500/150 <sup>3</sup>	500/150 <sup>3</sup>	500/150 <sup>3</sup>	1500
Max. number of other simultaneously active clients  (Sum of myPortal to go, myPortal for OpenStage, Application Launcher, OpenScape Business Attendant, OpenScape Business BLF and 3rd Party WSI Clients)	-	-	-	-	500
myPortal for Desktop	-	500/150 <sup>3</sup>	500/150 <sup>3</sup>	500/150 <sup>3</sup>	1500
myPortal for Outlook	-	500/150 <sup>3</sup>	500/150 <sup>3</sup>	500/150 <sup>3</sup>	1500
myAttendant	-	20	20	20	20
OpenScape Business Attendant	8	8	8	8	8
OpenScape Business BLF	30	250	250	250	500
	Max 350 BLF keys	Max 350 BLF keys	Max 350 BLF keys	Max 350 BLF keys	Max 350 BLF keys

**System Overview**  
OpenScape Business Models

	X1	X3R/X3W	X5R/X5W	X8	S
myAgent	-	192 configurable / 64 active concurrently	192 configurable / 64 active concurrently	192 configurable / 64 active concurrently	192 configurable / 64 active concurrently
Max. number of the mobile stations	-	250/150 <sup>3</sup>	250/150 <sup>3</sup>	250/150 <sup>3</sup>	250
Number of Mobility Entry User stations	-	150	150	150	250
myPortal to go	-	250/100 <sup>3</sup>	250/100 <sup>3</sup>	250/100 <sup>3</sup>	250
myReports	-	1	1	1	1
Max. number of simultaneous fax channels	-	8	8	8	8
Maximum number of Fax Users	-	500/150 <sup>3</sup>	500/150 <sup>3</sup>	500/150 <sup>3</sup>	1500
Maximum number of channels for UC conferences	-	20	20	20	60
<b>Unified Communications (CRM, database connectivity)</b>					
Application Launcher	30 configurable / 30 active concurrently	500 configurable / 50 active concurrently	500 configurable / 50 active concurrently	500 configurable / 50 active concurrently	500
TAPI 120/170 User (via CSTA, UC Booster Server / Card required)	-	500/150 <sup>3</sup>	500/150 <sup>3</sup>	500/150 <sup>3</sup>	1500
TAPI 120 User (in UC Smart mode via the mainboard without CSTA)	30	30	30	30	-
Directory Services Connector (UC Booster Card/Server required)	-	4	4	4	4
<b>Gate View</b>					
Cameras	-	8/2 <sup>3</sup>	8/2 <sup>3</sup>	8/2 <sup>3</sup>	8

1 Max. total number of IP and Deskshare Users = 20 (limited through configuration) - Max. total of IP, Deskshare, analog and digital stations = 30 (limited through licenses)

2 1st. value: maximum expansion with UC Booster Server / 2nd. value: maximum expansion with mainboard or UC Booster Card

3 1st. value: maximum expansion with UC Booster Server / 2nd. value: maximum expansion with UC Booster Card

For a detailed description of the expansion levels and capacity limits, see also [Configuration Limits and Capacities](#).

**OpenScape Business UC Networking**

OpenScape Business offers extensive network connectivity options:

- Extensive voice and UC networking between the various OpenScape Business X (UC Booster Card/Server required for UC networking) and OpenScape Business S
- with multiple buildings on the company premises
- with distributed locations
- Central administration, including licenses (HiPath 5000 RSM is no longer required)

- Voice networking with OpenScape Enterprise in preparation

Voice networking supports networks with up to 32 nodes. UC networking supports networks with up to 8 nodes and up to 1000 stations (1500 stations with OpenScape Business S). In addition, project-specific releases are possible.

For a detailed description of the networking scenarios, see [Configuration Limits and Capacities](#).

## 2.3.2 UC Hardware Models

The OpenScape Business X communication systems offer a high degree of flexibility in terms of functionality and design. Depending on the OpenScape Business X model, up to 500 stations are supported for IP, digital (ISDN), analog (a/b) and Cordless (DECT), and connections to the public network using ITSP (SIP), ISDN (BRI and PRI), CAS and analog and onboard IP (provisioned on the mainboard).

- OpenScape Business X1  
Communication system which comes in a wall housing and must be wall mounted.
- OpenScape Business X3W  
Communication system which comes in a wall housing and must be wall mounted.
- OpenScape Business X3R  
Communication system which comes in a 19-inch rack housing and can be installed in a 19-inch rack, as a standalone unit (desktop operation) or wall mounted.
- OpenScape Business X5 W  
Communication system which comes in a wall housing and must be wall mounted.
- OpenScape Business X5R  
Communication system which comes in a 19-inch rack housing and can be installed in a 19-inch rack, as a standalone unit (desktop operation) or wall mounted.
- OpenScape Business X8  
Modular communication system which can be used as a one-box system (base box) or two-box system (base box + expansion box). The communication system can be installed as a standalone unit or mounted in a 19-inch rack.

**Figure:** Hardware Platforms

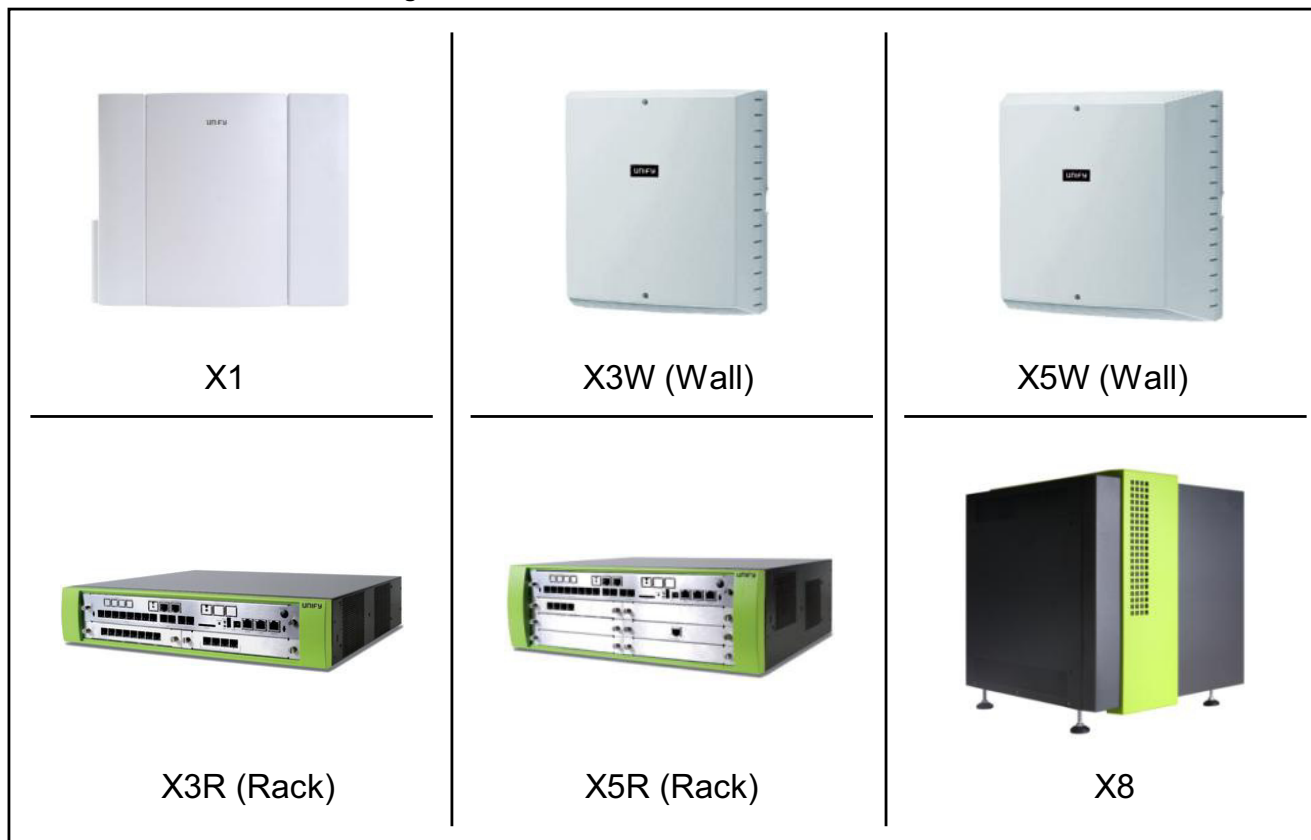

### 2.3.3 UC Booster Hardware

UC Booster Hardware for OpenScope Business X.

- OpenScope Business UC Booster Card  
Board for OpenScope Business X if UC Suite is to be used as a UC solution with up to 150 UC users.
- OpenScope Business UC Booster Server  
External UC Booster Server (Linux) for OpenScope Business X if UC Suite is to be used as a UC solution with up to 500 UC users.  
SLES 11 SP4 64 Bit is used on the UC Booster Server. The UC Booster Server can also be run in a virtual environment with VMware vSphere.  
When using the UC Booster Server, the UC Booster Card is not required.
- OpenScope Business Voice Channel Booster Card  
Two optional modules for the extension of OpenScope Business X with additional DSP channels (e.g., for simultaneous voice connections with IP/TDM transitions).  
Eight DSP channels are provided on the mainboard. The Voice Channel Booster Card OCCB/1 provides a further 48 DSP channels, and the Voice Channel Booster Card OCCB/3 provides up to 128 DSP channels.

## 2.3.4 UC Software Models (Softswitch)

All-in-one server-based UC software solution that supports up to 1000 IP stations with connections to the public network using ITSP (SIP).

Independent of the platform used, OpenScope Business S can be installed on a Linux server. SLES 11 SP4 64 Bit is used as the operating system. OpenScope Business S can also be run in a virtual environment with VMware vSphere. If TDM interfaces are required for connection to TDM telephones or TDM trunks, OpenScope Business X systems can be used as a gateway.

## 2.3.5 Structure and Environmental Conditions

	X1	X3W	X3R	X5W	X5R	X8
Structure	Wall-mount system	Wall-mount system	Rack	Wall-mount system	Rack	Standard system (rack installation also possible)
Dimensions (HxBxT in mm)	470x370x80	450x460x130	89x440x380 (2U)	450x460x200	155x440x380 (3,5U)	490x440x430
Weight	about 2.8 kg	about 6 kg	about 6 kg	about 8 kg	about 8 kg	about 34 kg (fully loaded)
Housing color	White	White	Green / Dark Grey	White	Green / Dark Grey	Green / Dark Grey
Power supply	The models are equipped for connection to the power supply. <ul style="list-style-type: none"> <li>Rated input voltage (AC): 100 to 240 V</li> <li>Nominal frequency: 50/60 Hz</li> <li>Battery power (DC): -48 V</li> </ul>					
Power consumption	Depending on the hardware platform and expansion					
Environmental Conditions	<ul style="list-style-type: none"> <li>Operating conditions: +5 to +40 °C (41 to 104 °F)</li> <li>Humidity: 5 to 85%</li> </ul>					

## 2.3.6 Supported Phones

OpenScope Business X enables telephony over IP/HFA (HiPath Feature Access), SIP, TDM, a/b, Cordless/DECT and WLAN. IP/HFA, SIP and wireless phones can be connected to OpenScope Business S.

OpenStage telephones (IP/HFA, SIP and T)	<ul style="list-style-type: none"> <li>• OpenStage 5/10/15/20/30/40/60/80</li> </ul>
OpenScape Desk Phone (IP/HFA, SIP)	<ul style="list-style-type: none"> <li>• OpenScape Desk Phone IP 35G/55G</li> <li>• OpenScape Desk Phone IP 35G Eco</li> <li>• OpenScape Desk Phone CP 200/205/400/600 HFA and SIP</li> </ul>
Key modules	<ul style="list-style-type: none"> <li>• OpenStage Key Module, only for OpenStage 15/40/60</li> <li>• OpenStage BLF 40 (Busy Lamp Field), only for OpenStage 40 and OpenStage 30 T</li> <li>• OpenScape Key Module 400/600, only for CP devices</li> </ul>
OpenScape Business Cordless	<ul style="list-style-type: none"> <li>• OpenStage S5/M3/SL4</li> </ul>
PC clients (HFA, SIP)	<ul style="list-style-type: none"> <li>• OpenScape Personal Edition (incl. video for SIP)</li> </ul>
SIP phones (UC Suite) / AP adapter	<ul style="list-style-type: none"> <li>• SIP phones with RFC 3725 support</li> <li>• Mediatrix 4102S (for connecting 2 analog phones or Fax devices)</li> </ul>
WLAN Phones	<ul style="list-style-type: none"> <li>• OpenStage WL3 professional</li> </ul>
Analog and ISDN phones	<ul style="list-style-type: none"> <li>• Analog (a/b) phones</li> <li>• Digital (S<sub>0</sub>) ISDN phones</li> </ul>

Older devices (such as optiPoint 410/420/500, Gigaset M2/SL3/S4 and optiPoint WL2 SIP) are supported. Optiset E devices cannot be operated.

### Functions and Configuration of SIP Phones

OpenScape Business offers an extensive range of voice communication features for OpenStage HFA telephones. Many functions are also available for standard SIP phones.

An overview of the features supported with OpenStage SIP telephones and further information can be found in the Unify wiki at the following link

[http://wiki.unify.com/wiki/Features\\_and\\_Configuration\\_of\\_SIP\\_Devices](http://wiki.unify.com/wiki/Features_and_Configuration_of_SIP_Devices)

To control voice calls for SIP telephones using CTI (3PCC), a UC Booster Card or a UC Booster Server is required for OpenScape Business X3/X5/X8.

The control of voice calls for SIP telephones via UC Smart clients is supported for the OpenScape Business X3/X5 rack models with the Booster Card.

With the help of the DLI functions, the OpenScape Desk Phone (SIP) telephones can be centrally administered and supplied with software.

## 2.4 Further information

Further information can be found on the Internet and extranet. See also the release notes for limitations and recent changes.



## 2.4.1 Languages Supported

Several different language variants are available for the various software components (clients and WBM) and documentation/online help.

The following languages will be released as part of the country-specific introduction.

	de en	es fr it nl pt	da no sv	fi	ru	cs	pl	hr tr	hu	zh
<b>UC Smart Clients</b>										
myPortal Smart (Client)	X	X	X	X	X	X	X	X	X	–
myPortal Smart (User Guide)	X	X	–	–	–	–	–	–	–	–
myPortal to go (Client)	X	X	X	X	X	X	X	X	X	–
myPortal to go (User Guide/Online Help)	X	X	X	X	X	X	X	–	–	–
myPortal for OpenStage (Telephone)	X	X	X	X	X	X	X	X	X	–
myPortal for OpenStage (User Guide)	X	X	–	–	–	–	–	–	–	–
TUI (Telephone User Interface)	X	X	X	X	X	X	–	X	–	X
TUI (Quick Reference Guide)	X	X	–	–	–	–	–	–	–	–
OpenScape Business Attendant / BLF (Client)	X	X	–	–	–	X	–	–	–	–
OpenScape Business Attendant / BLF (User Guide)	X	X	–	–	–	X	–	–	–	–
<b>UC Suite Clients</b>										
myPortal for Desktop (Client)	X	X	X	X	X	X	X	X	X	X
myPortal for Desktop (User Guide/Online Help)	X	X	X	X	X	X	X	–	–	–
myPortal for Outlook (Client)	X	X	X	X	X	X	X	X	X	X
myPortal for Outlook (User Guide/Online Help)	X	X	X	X	X	X	X	–	–	–
myPortal to go (Client)	X	X	X	X	X	X	X	X	X	–
myPortal to go (User Guide/Online Help)	X	X	X	X	X	X	X	–	–	–
myPortal for OpenStage (Client)	X	X	X	X	X	X	X	X	X	–
myPortal for OpenStage (User Guide)	X	X	–	–	–	–	–	–	–	–
myAttendant (Client)	X	X	X	X	X	X	X	X	X	X
myAttendant (User Guide/Online Help)	X	X	X	X	X	X	X	–	–	–
myAgent (Client)	X	X	X	X	X	X	X	X	X	X
myAgent (User Guide/Online Help)	X	X	X	X	X	X	X	–	–	–
myReports (Client)	X	X	–	X	X	X	X	–	–	–
myReports (User Guide/Online Help)	X	X	–	X	X	X	X	–	–	–
TUI (Telephone User Interface)	X	X	X	X	X	X	X	X	X	X

**System Overview**  
Further information

	de en	es fr it nl pt	da no sv	fi	ru	cs	pl	hr tr	hu	zh
TUI (Quick Reference Guide)	X	X	–	–	–	–	–	–	–	–
<b>Administration</b>										
OpenScape Business Assistant (WBM)	X	X	–	–	–	–	–	–	–	–
OpenScape Business Assistant (Administrator Documentation/Online Help)	X	X (no nl)	–	–	–	–	–	–	–	–
Manager E	X	X	X	X	X	X	X	–	–	–
Manager E (Administrator Documentation/Online Help)	X	X	–	–	X	–	–	–	–	–

In addition, the UC Smart TUI is also offered in the languages Belgian (Flemish) and Slovenian.

---

**INFO:** A Russian or Chinese Windows operating system is required in order to use the Russian or Chinese user interface.

---

The following language codes (ISO 639-1) are used for the abbreviations in the table:

- de = German
- en = English
- cs = Czech
- da = Danish
- es = Spanish
- fi = Finnish
- fr = French
- hr = Croatian
- hu = Hungarian
- it = Italian
- nl = Dutch
- no = Norwegian
- pl = Polish
- pt = Portuguese
- ru = Russian
- sv = Swedish
- tr = Turkish
- zh = Chinese

## 2.4.2 Internet Links

More details and possibly more up-to-date information can be found on the Unify homepage, our expert wiki and the Unify portal for partners.

### Internet Links

- **Unify homepage:**  
<http://www.unify.com>
- **Expert wiki for telephones, communication systems and UC:**  
<http://wiki.unify.com>
- **Partner Portal (registration required):**  
<https://www.unify.com/de/partners/partner-portal.aspx>  
or  
<https://www.unify.com/en/partners/partner-portal.aspx>

## **3 Administration Concept**

The administration of the communication system is performed with the OpenScape Business Assistant.

### **3.1 OpenScape Business Assistant (WBM)**

The OpenScape Business Assistant is web-based and is therefore also called Web-Based Management (WBM).

The scope of administrative tasks offered depends on the administrator profile being used.

An online help is available for each page of the WBM.

#### **3.1.1 Requirements for the WBM**

In order to use the WBM, the administration PC must have the appropriate software installed.

Supported Web browsers:

- Microsoft Internet Explorer 10 or later
- Mozilla Firefox 18 or later
- Google Chrome

#### **3.1.2 Home Page of the WBM**

The home page of WBM displays important system information, which is split into different areas (tiles). In addition, it includes notes and provides information on system errors, events and actions.

The presented system information depends on the administrator profile being used. The underlined headings in the individual areas are clickable and reference the related topic in the WBM.

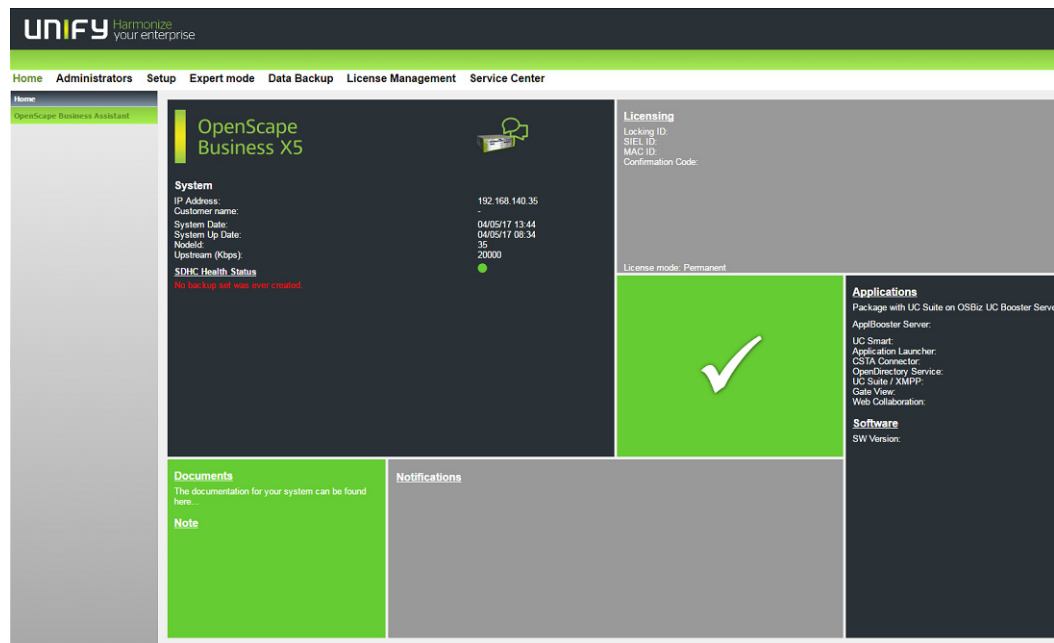

The following information is displayed:

- Area: **Status** (Middle)
  - White check mark on green background: the communication system is fully functional - Messages highlighted in red in the other fields indicate actions that should be performed.
  - White check mark on red background: the communication system is not fully functional and requires the intervention of the administrator - Messages highlighted in red in the other fields indicate system errors or events that need to be resolved.
- Area: **System**
  - Brand
  - IP address of the communication system
  - Current date and time
  - Date and time of the last system restart
  - Notes when operating in an internetwork (system is master or slave, display of node ID)
  - Synchronization status
  - Bandwidth Upstream in kbps
  - SDHC Health Status
  - Notes on performing a backup and restore
  - Booster Card status
- Area: **Documents**
  - Link to the documentation
- Area: **Notifications**
  - Various notifications about the system
- Area: **Note**

## Administration Concept

### OpenScape Business Assistant (WBM)

- Displays the latest information entered by an administrator. Clicking on the underlined title opens a text window in which all the information is displayed and further information can be entered.
- Area: **Licensing**
  - Locking ID for licensing
  - SIEL ID for licensing
  - Note on the licensing status, indicating if the system is in "Permanent" license mode or in "Pay As You Go" mode.
- Area: **Inventory**
  - Type and number of active stations
  - Number of activated ITSPs and a link to the ITSP status dialog in Service Center of active stations
- Area: **Applications** and Software
  - Applications:
    - Used application package (UC Smart or UC Suite) and its components, including the IP addresses of the servers used.
    - Indicates whether a UC Booster Card is inserted.
  - Software:
    - Version of the installed communication system software
    - Indicates whether a UC Booster Card is inserted. If the Booster Card is additionally accessible via an IP address, the version of the installed UC Booster Card software is displayed.  
The UC Booster Card and the communication system should always be on the same software version.
    - Expiration date of the 3-year software support.  
After the expiration date the message "Software Support licence has been expired, please update the Software Support licence" is displayed.
    - Note on the new software version

### 3.1.3 Introduction to the WBM

WBM is the web-based application for the administration of the system.

#### Language of the User Interface

You can select one of the following languages at login:

- German
- English
- French
- Italian
- Dutch (The online help is only available in English)
- Portuguese
- Spanish

### Ranking of the User Interfaces Described

Any tasks which can be performed in a wizard are described for the corresponding wizard only.

Any additional tasks which can be performed in Expert mode are described for the Expert mode only.

Any other remaining tasks are described for E Manager.

### User Interface Elements

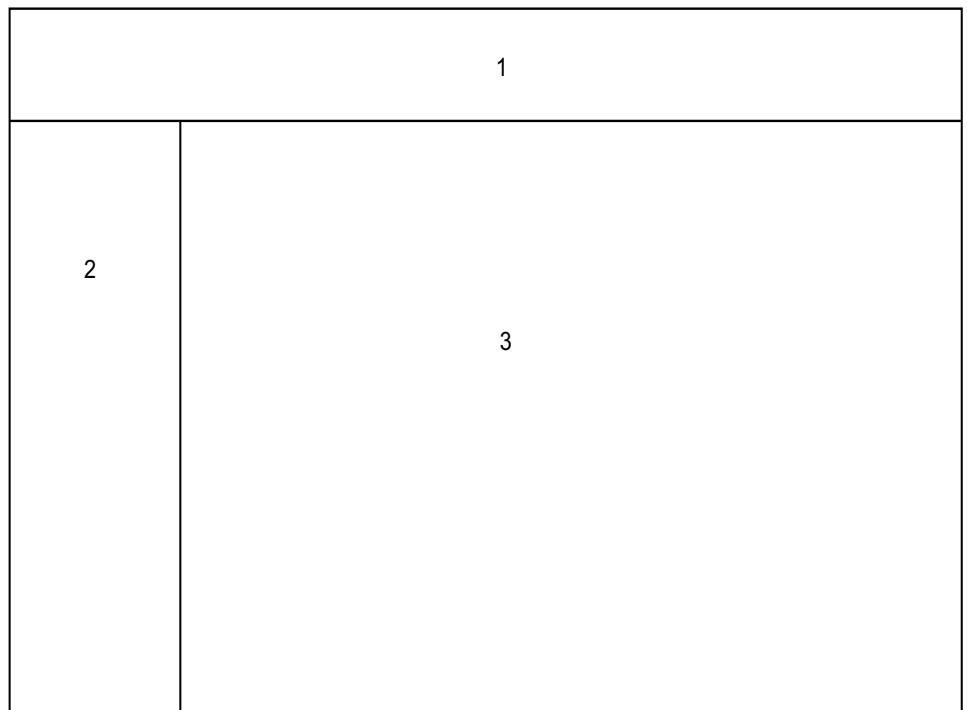

- **Navigation bar (1)**  
The navigation is the primary navigation aid and always shows the same links to main task centers, i.e., **Home, Administrators, Setup, Expert Mode, Data Backup, License Management, Service Center** as well as the current user name and the **Logout** link. When you click on one of these task centers, the associated navigation tree opens in the navigation area, and the home page of the task center appears in the workspace.
- **Navigation area (2)**  
The navigation area is the secondary aid and contains the navigation tree with the menu items of the selected task center. The name of the selected task center is displayed at the top of the navigation tree with expandable and collapsible menu groups and menu items below it. Different menu items are displayed in the menu groups, depending on the situation. Clicking on a menu item displays the associated page in the workspace.
- **Workspace (3)**  
The workspace is where administration tasks are performed. It is usually opened in a separate window. The number and selection of messages and

actions displayed depends on the menu item selected in the navigation tree. In Expert mode, the menu tree is displayed on the left in the workspace.

### **Navigating in the Menu Tree**

The menu tree is used for navigation in the Expert mode of the WBM. The menu tree contains folders (e.g., **Maintenance**) with further elements (e.g., **Restart / Reload**).

You can navigate in the menu tree by clicking on a folder (which toggles its expanded or collapsed state).

### **Automatic Logout After Timeout**

You are automatically logged off after 30 minutes of inactivity. You must log in again to continue working with the WBM. If you make some changes and then take a break, to be on the safe side, you should reload the page before making any further changes so that no changes are lost due the automatic logout.

## **3.1.3.1 How to Log into the WBM**

### ***Prerequisites***

- You must have access to your user credentials (user name and password). If not, obtain this from your administrator.
- TLS 1.2 is enabled in your web browser settings.

### ***Step by Step***

- 1) Open the login page in your web browser by entering the following address: `https://<IP address of communication system>`. The default IP address is 192.168.1.2.
- 2) Click on the language code at the top right and select the language in which the user interface of the WBM is to be displayed from the menu. The Login page will be displayed in the selected language.
- 3) Enter the user name under **Login** in the first field. "@system" is added automatically on exiting the field.
- 4) Enter your password in the second field under **Login**. Note case usage and the status of the **Num** key. The password is shown with asterisks (\*).
- 5) Click **Login**.

## **3.1.3.2 How to Log out from the WBM**

### ***Step by Step***

- › Click **Logout** at the top right of the screen.



## 3.1.4 WBM User Management

You can configure and manage up to 16 administrators for WBM (web-based management). Every administrator is assigned a profile that specifies the scope of his or her authorization. You can also change the password of a Manager E administrator.

The users of WBM are also referred to as administrators.

The default Administrator is `administrator@system` with the default password `administrator` and has the profile **Advanced**. This password must be changed on logging in for the first time. The password for an administrator must consist of at least 8 characters and a maximum of 128 characters, of which at least one character must be a digit. In addition, for a secure password, at least an uppercase letter, one lowercase letter and one special character should be included in the password.

### Profiles

The WBM supports four profiles with different classes of service (authorizations) for administrators with different levels of technical expertise and tasks.

In order to prevent that no malicious user could login via ISDN and change the default password when logging in for the first time, it is compulsory for the user to change the password via Manager E as an installation step.

---

**INFO:** A password, which consists of 5 characters (\*\*\*\*\*), will not be accepted by the system for security reasons.

---

**Table:** Profile Classes of Service

<b>Profile</b>	<b>Class of Service</b>
<p><b>Basic</b></p> <p>Basic knowledge of configuring the system</p>	<p>System information on the home page</p> <p><b>Key Programming</b> wizard</p> <p><b>Phone Book / Speed Dialing</b> wizard</p> <p><b>Call Detail Recording</b> wizard</p> <p><b>Music on Hold / Announcements</b> wizard</p> <p><b>Station name and release</b> wizard</p> <p>Access to <b>Administrators</b> (only to change their own passwords)</p> <p>Access to <b>License Management &gt; License Information</b></p> <p>Access to <b>Service Center &gt; Documents</b></p> <p>Access to <b>Service Center &gt; Software</b></p>
<p><b>Enhanced</b></p> <p>Good knowledge of configuring the system</p>	<p>As for the <b>Basic</b> profile, plus:</p> <p>Access to all wizards (except the <b>Basic Installation, UC Suite</b> and <b>UC Smart</b> wizards)</p> <p>IMPORTANT: Access to all wizards is not supported in OpenScope Business S systems.</p> <p>Access to <b>Administrators</b> (only to change their own passwords)</p> <p>Access to <b>Backup And Restore</b></p> <p>Access to <b>License Management</b> (excluding registration, license activation and settings)</p> <p>Access to <b>Service Center &gt; Inventory</b></p> <p>Access to <b>Service Center &gt; Restart / Reload</b> (without reload)</p> <p>Access to <b>Service Center &gt; Diagnostics &gt; Status</b></p> <p>Access to <b>Service Center &gt; Diagnostics &gt; Event Viewer</b></p>
<p><b>Advanced</b></p> <p>Trained users</p>	<p>As for the <b>Enhanced</b> profile, plus:</p> <p>Access to all wizards</p> <p>Access to <b>Administrators</b> (only to change their own passwords)</p> <p>Access to the complete <b>License Management</b></p> <p>Access to the complete <b>Service Center</b></p> <p>Access to <b>Networking</b></p>
<p><b>Expert</b></p> <p>Trained service technicians</p>	<p>As for the <b>Advanced</b> profile, plus:</p> <p>Access to <b>Administrators</b> (complete)</p> <p>Access to the <b>Expert mode</b></p>

**Table:** Profile Management

Profile	Maintenance
<b>Basic</b> Basic knowledge of configuring the system	Can change own password. Does not see any other configured administrators except himself or herself.
<b>Enhanced</b> Good knowledge of configuring the system	Can change own password. Does not see any other configured administrators except himself or herself.
<b>Advanced</b> Trained users	Can change own password. Does not see any other configured administrators except himself or herself.
<b>Expert</b> Trained service technicians	Can change own password and the user names and passwords of other administrators. Sees all configured administrators. Can add, edit and remove administrators.

---

**INFO:** As long as no administrator with the **Expert** profile exists, administrators with the **Advanced** profile can add, edit and remove further administrators. As soon as an administrator with the **Expert** profile exists, only administrators with the **Expert** profile can add, edit and remove further administrators.

---

### Administrator Management in the Internetwork

The direct management of administrators is only possible in the WBM of the master node. The **Administrator** menu is not displayed on slave nodes. All administrator configurations are transmitted to the slave nodes. It is, however, possible to call up the WBM of the master node from within the WBM of the slave node via the Node View. The **Administrator** menu is displayed here, and administrators can then be managed.

### Manager E Password Administration

An administrator can change (but not create a new user role) the password of the existing users which can access the embedded system through Manager E.

User will be prompted to change passwords only for the existing users and will not be able to change the user's Group and options like Created, Last Used are not viewable. This is a security feature and thus it does not provide the whole Manager E's administration screen.

### 3.1.4.1 How to Add an Administrator

#### *Prerequisites*

- You are logged on to the WBM with the **Advanced** profile. (As long as no administrator with the **Expert** profile exists.)
- You are logged into the WBM with the **Expert** profile. (If an administrator with the **Expert** profile already exists.)

#### *Step by Step*

- 1) Click on **Administrators** in the navigation bar.
- 2) Click on **Add...**
- 3) Enter the following data: **Login Name, First Name, Last Name, Password, Retype Password.**
- 4) Select the desired user profile from the **User Role** drop-down list.
- 5) Click on **OK & Next.**

### 3.1.4.2 How to Edit an Administrator

#### *Prerequisites*

- You are logged into the WBM with the **Expert** profile.

#### *Step by Step*

- 1) Click on **Administrators** in the navigation bar.
- 2) Select the check box for the desired administrator in the **Administrators List.**
- 3) Click on **Edit.**
- 4) Edit the data (login name, first name and last name, password, and user role) as required.
- 5) Click **OK & Next.**

### 3.1.4.3 How to Change your Own Administrator Password

#### *Prerequisites*

- You are logged into the WBM with the **Expert** profile.

#### *Step by Step*

- 1) Click on **Administrators** in the navigation bar.
- 2) Enter the new password in the **Password** and **Retype Password** fields.

---

**INFO:** A password, which consists of 5 stars (\*\*\*\*\*), will not be accepted by the system for security reasons.

---

- 3) Click **OK & Next**.

### 3.1.4.4 How to Delete an Administrator

#### *Prerequisites*

- You are logged into the WBM with the **Expert** profile.

#### *Step by Step*

- 1) Click on **Administrators** in the navigation bar.
- 2) Select the check box for the relevant administrator in the relevant **Administrators List**.
- 3) Click on **Delete....**

### 3.1.4.5 How to change a Manager E Administrator password

#### *Prerequisites*

- You are logged into the WBM with the **Expert** profile.

#### *Step by Step*

- 1) Click on **Administrators** in the navigation bar.
- 2) Click on Manager E **AdministratorsList**.
- 3) Edit the data (User Accounts, New Password, Confirm Password) as required.
- 4) Click on **Save**.

---

**INFO:** Well known default passwords are not accepted in this case. If the user attempts to enter this kind of passwords an error message appears, noting that "well known passwords are not accepted". The password must consist of at least 8 characters, of which at least one character must be a digit. In addition, for a secure password, at least an uppercase letter, one lowercase letter and one special character should be included in the password.

---

## 3.1.5 Wizards

Wizards make it easy to install and configure the system. Only selected subset of the wizards are available to a customer administrator (with the **Basic** profile). A trained service technician or an administrator with expertise (with the **Advanced** profile), by contrast, can access all the wizards.

The available wizards depend on the system configuration (UC Smart or UC Suite). Wizards can consist of several pages in succession. OK & Next saves changes and switches to the next page in the wizard. There is no undo function for changes committed with OK & Next. If no changes were saved, **Abort** closes the wizard. Clicking the **X** symbol in the upper right corner of the wizard window terminates the wizard and retains the changes previously saved with OK & Next.

### 3.1.5.1 Wizards – Basic Installation

The wizards under **Basic Installation** support the simple basic installation.

The following wizards are available under **Basic Installation**:

- **Initial installation**  
Single usage at initial setup. Country initialization, System IP address and DHCP server.
- **Basic Installation**  
Basic setup of system with station data, trunks, network parameters and Internet.
- **Licensing**  
Activating licenses online via the License Server.
- **Networking Configuration**  
Setup of system as part of a network.
- **Power Management**  
Setup and Activation of Power Management

### 3.1.5.2 Wizards – Network / Internet

The wizards under **Network / Internet** support the simple configuration of networks and the Internet access.

The following wizards are available under **Network / Internet**:

- **Network Configuration**  
Set up DHCP, IP Routing and DNS Server.
- **Internet Configuration**  
Access parameters of the Internet Provider data, e.g., User Account and Password.
- **VPN Configuration**  
Connection of workplaces via the Internet.

### 3.1.5.3 Wizards – Telephones / Subscribers

The wizards under **Telephones / Subscribers** support the simple configuration of phones and subscribers.

The following wizards are available under **Telephones / Subscribers**:

- **IP devices**  
Set up system-specific IP and SIP telephones, FAX call numbers as well as IP/analog adapters.
- **UP0 devices**  
Set up UP0 Telephones, FAX call numbers.
- **Portable parts (DECT devices)**  
Set up DECT phone, FAX call numbers.
- **ISDN devices**  
Unpowered ISDN ports for ISDN cards / modems and S0 stations.
- **Analog Terminals**  
Analog DTMF and CLIP-capable ports for Fax and Telephone.
- **Key programming**  
Name and function key programming for system-specific IP devices and UP0 devices.

### 3.1.5.4 Wizards – Central Telephony

The wizards under **Central Telephony** support the simple configuration of central telephony features.

The following wizards are available under **Central Telephony**:

- **CO Trunk ISDN / Analog / ITSP**  
Point-to-multipoint connections (MSN) and PABX number for ISDN connections, and assignment of analog and ITSP trunks.
- **Internet Telephony**  
Access parameters of the Internet Telephony Service Provider (ITSP), e.g., user account, password, SIP station number.
- **Directory / Speed Dialing**  
Set up central speed-dial destinations for the system's internal phone book.
- **Call Detail Recording**  
Set up call detail recording connection parameters for call detail applications.
- **Music on Hold / Announcements**  
Record new melodies and announcements for Music on Hold and announcement before answering.
- **Entrance Telephone (Door Opener)**  
Set up call allocation and access authorization for the entrance telephone at the analog station connection.
- **SmartVM**  
Setup of the UC Smart voicemail box (SmartVM).

### 3.1.5.5 Wizards – User Telephony

The wizards under **User Telephony** support the simple configuration of user telephony features.

The following wizards are available under **User Telephony**:

- **Class of Service**  
Set up classes of service with external call numbers that can be assigned to subscribers, e.g., emergency numbers, allowed numbers, denied numbers and assignment of class of service for night service.
- **Station Name and Release**  
Edit station and group names and reset lock code for individual stations.
- **Group call / Hunt group**  
Set up incoming calls for station groups (parallel, linear or cyclical call order).
- **Call Forwarding**  
Set up central system-wide station number assignments, and forwarding "after timeout" and "on busy".
- **Call pickup**  
Configure stations in a pickup group with the option of answering each other's calls.
- **Team Configuration**  
Setting up stations which are called concurrently with the main station for incoming calls and which can use its station number for outgoing calls.
- **Mobile Phone Integration**  
Set up a link between a mobile phone and an internal station with the goal of enabling incoming and outgoing availability under one station number (One Number Service).
- **Executive / Secretary**  
Set up a link between one or more Executive phones and one or more Secretary phones with the goal of enabling simplified call transfers and ring transfers.
- **UCD**  
Set up an automatic intelligent call distribution to a group with selected stations.
- **Attendant Console**  
Set up stations as attendant console numbers and station behavior for on busy, incorrect dialing and no answer.
- **Station Profiles**  
Assign stations to a profile and import/export profile data.

### 3.1.5.6 Wizards – Security

The wizards under **Security** support the simple configuration of the firewall.

The following wizards are available under **Security**:



- **Firewall**  
Configure port opening to restrict Internet traffic.

### 3.1.5.7 Wizards - UC Smart (only with UC Smart)

The setup of the UC solution UC Smart is supported by wizards under **UC Suite**.

The following wizards are available under **UC Smart** :

- **UC Smart**  
Basic Setup and User Configuration for UC Smart.

### 3.1.5.8 Wizards - UC Suite (only with UC Suite)

The setup of the UC solution UC Suite is supported by wizards under **UC Suite**.

The following wizards are available under **UC Suite**:

- **User Directory**  
Configuration of users.
- **Departments**  
Configuration of departments.
- **Groups**  
Configuration of voicemail and fax groups.
- **Templates**  
Configuration of SMS templates.
- **External Directory**  
Manual addition of individual contacts to the external directory.
- **External Providers Config**  
Input of access data for the Exchange or LDAP server.
- **Contact Center**  
Configuration of the Contact Center.
- **Schedules**  
Configuration of schedules.
- **File Upload**  
Uploading of audio files for announcements and music on hold.
- **Conferencing**  
Configuration of conference calls.
- **Profiles**  
Creation of user profiles.
- **Fax Headlines**  
Configuration of fax headers.
- **Skin Settings**  
Management of user interfaces.

### 3.1.5.9 Wizards – Circuit

The wizards under **Circuit** support the usage of Circuit functionality.

The following wizards are available under **Circuit**:

- **Circuit Connectivity**  
Basic settings configuration for Circuit including hUTC.
- **Circuit user instance**  
Configure Circuit users instance.

### 3.1.5.10 Wizards – Unified Directory

The wizards under **Unified Directory** support the importing and editing of directory contacts.

The following wizards are available under **Unified Directory**:

- **Import Contacts**  
The Wizard will guide you through the import of contact data to the Global Directory from CSV.
- **Edit Contacts**  
Manually add or edit Global Directory entries.

## 3.1.6 Service Center

The **Service Center** of the WBM offers various maintenance functions, starts the software update and makes the documentation and software available.

### 3.1.6.1 Service Center – Documents

The **Documents** option provides documentation, CSV templates and links to related information. The documentation can be accessed in all the supported languages in PDF format.

Depending on the system configuration, the following contents are available:

Contents	UC Smart	UC Suite
Administrator Documentation (PDF)	-	x

Contents	UC Smart	UC Suite
User Guides (PDF)	-	x
Links to further information	x	x
CSV templates for importing data for <ul style="list-style-type: none"> <li>• Stations</li> <li>• System Speed Dialing</li> <li>• External directory</li> </ul>	x	x

### 3.1.6.2 Service Center – Software

The **Software** option provides the software for the UC clients, USB drivers and tools.

The following contents are available:

Contents	UC Smart	UC Suite
Installation files for the software of the UC clients	x	x
USB drivers	x	x
Tools	x	x
Links for direct access to the installation files	-	x

### 3.1.6.3 Service Center – Inventory

**Inventory** provides an overview of the basic configuration data of the system.

### 3.1.6.4 Service Center – Software Update

**Software Update** checks whether a software update is available on the web server and performs the update.

### 3.1.6.5 Service Center – E-mail Forwarding

**E-mail Forwarding** enables the sending of e-mails with system messages from the UC Suite to the administrator and e-mails with attached voicemail of fax messages to subscribers.

## Administration Concept

OpenScape Business Assistant (WBM)

### 3.1.6.6 Service Center – Remote Access

**Remote Access** is used to configure access for the site-independent administration of the system.

### 3.1.6.7 Service Center – Restart / Reload

**Restart / Reload** enables a restart of the system, optionally resetting it back to factory settings.

### 3.1.6.8 Service Center – Diagnostics > Status

**Status** provides status information on the network, subscribers, call setup, ITSP and VPN.

See also [Inventory Management](#).

### 3.1.6.9 Service Center – Diagnostics > Event Viewer

**Event Viewer** logs system events.

See also [Traces](#).

### 3.1.6.10 Service Center – Diagnostics > Trace

**Trace** provides options for fault logging.

See also [Traces](#).

### 3.1.6.11 Service Center – Diagnostics > Service log

**Service log logs several system data in the form of HiPath 3000 Event.**

It is necessary to be on WBM View mode, to refresh or download the file.

## 3.1.7 Expert Mode

The Expert mode provides trained service technicians (**Expert** profile) with several menus and functions to configure and maintain the system.

Detailed information can be found in the section on [Expert mode](#).

## 3.1.8 Online Help

The integrated online help describes key concepts and operating instructions. The online help is context-sensitive and opens the associated Help topic for each opened WBM page.

### Navigation

The buttons in the online help provide the following functions:

- **Contents**  
provides you with an overview of the structure
- **Index**  
provides direct access to a topic using keywords
- **Search**  
allows you to do a full-text search and selectively find all relevant topics

### 3.1.8.1 How to Invoke the Context-Sensitive Online Help

#### *Prerequisites*

- You are logged in at the WBM.

#### *Step by Step*

- › Click in the open WBM window on either the question mark icon at the top right or the Help button at the bottom left.

## 3.2 Manager E

Manager E is a service tool with integrated help that runs under Windows and can be used for tasks which cannot be performed via the WBM.

Manager E can be used for OpenScape Business X1, OpenScape Business X3, OpenScape Business X5 and OpenScape Business X8. OpenScape Business S cannot be administered using Manager E.

Manager E is intended for trained service personnel and includes the following function blocks:

- Generation (including off-line generation)
- Copying and backing up customer data
- Service orders, such as restarting boards
- Resetting activated features
- Creation and printing of:
  - Key labels for optiPoint 500

- Customer data printouts
- Main distribution frame layout
- Separate user and password administration for after sales service.
- Database conversion routine for customer database (CDB).

System access via Manager requires a user name and a password. The Online mode can be used to perform changes quickly. The functionality of the Online mode corresponds to the Assistant T user interface.

The following features can no longer be administered using Manager E:

- Licensing
- Network
  - SNMP Partner
  - PSTN Peer
  - Routing
  - Mapping
  - Gatekeeper
  - Ext. H.323
  - IP Ports
- Maintenance
  - Error History
  - Event Log
  - Trace settings
  - Error Reaction Table
  - V.24 Status
  - DMA
- Traces

### **Working with the Customer Database (CDB)**

The basic steps are as follows:

- Load the CDB from the system into Manager E
- Make any necessary changes in E Manager
- Use Manager E to store the CDB back on the system

## **3.2.1 How to Load the CDB into Manager E**

Perform the following steps, and then proceed to perform configuration tasks in E Manager.

### ***Step by Step***

- 1)** Start Manager E on the admin PC.
- 2)** Enter the **User name** for Manager E.
- 3)** Enter the **Password** for Manager E.

- 4) Click on **File > Transfer**.
- 5) Click on the **Communications** tab.
- 6) Select the appropriate option in the **Access** area, depending on the type of connection from the admin PC to the communication system.
- 7) Activate the **Read/write database** option.
- 8) Click on **System -> PC**.
- 9) Click on **OK**. The CDB is transferred from the system to Manager E.
- 10) Click **OK** once the transfer has been successfully completed.
- 11) Click on **Close**.

### 3.2.2 How to Load the CDB Back into the System

The configuration saved in Manager E can be loaded back into the system by performing the following steps:

#### *Step by Step*

- 1) Click on **File > Transfer**.
- 2) Click on the **Communications** tab.
- 3) Select the appropriate option in the **Access** area, depending on the type of connection from the admin PC to the communication system.
- 4) Activate the **Read/write database** option.
- 5) Click on **PC -> system**.
- 6) Click on **OK**. The CDB is transferred from Manager E to the system.
- 7) Click **OK** once the transfer has been successfully completed.
- 8) Click on **Close**.

## 4 Initial Setup for OpenScape Business X

This chapter describes the initial setup of OpenScape Business X1/X3/X5/X8. The communication system and its components are integrated into an existing infrastructure consisting of a customer LAN and a TDM telephony network. Internet access and the trunk connection are set up and the connected stations are configured.

The initial setup of OpenScape Business X1/X3/X5/X8 (i.e., the communication system) is carried out using the OpenScape Business Assistant administration program (web-based management, also called WBM).

The standard initial setup of commonly used components is described here. The specific installation steps depend on the communication system and the components (e.g., the UC Booster Card) involved. During the initial setup, you may need to choose between multiple options in some places or even skip some configurations entirely. It is also possible that the installation steps described here do not appear in your communication system.

The detailed configurations of features not covered by the standard initial setup are described in subsequent chapters.

The initial setup requires the creation of an IP address scheme and a dial plan.

The most important installation steps are as follows:

- IP addresses and DHCP settings
- Country and Time Settings
- System Phone Numbers and Networking
- ISDN Configuration
- Internet access
- Internet telephony
- Station configuration
- Licensing
- Data backup

### 4.1 Prerequisites for the Initial installation

Meeting the prerequisites for the initial installation ensures the proper operation of the communication system.

#### **General**

Depending on the existing hardware (boards, phones, ...) and infrastructure, the following general conditions apply:

- The infrastructure (LAN, TDM telephony network) is available and usable.
- The hardware is installed and connected properly.



- One LAN port each is required to integrate the mainboard and the UC Booster Card in the customer LAN.
- The communication system has not yet been connected to the LAN.
- If the UC Booster Card is used, it should be inserted prior to the initial installation.
- Internet access is available through an Internet Service Provider.
- An ISDN S<sub>0</sub> or ISDN Primary Rate Interface is required for using ISDN outside lines.
- A CAS trunk connection is required for using a CAS outside line.
- An analog trunk connection is required for using an analog outside line.
- An IP address scheme exists and is known (see [IP Address Scheme](#)).
- A dial plan (also called a numbering plan) is present and known (see [Dial Plan](#)).

### Admin PC

The following prerequisites must be fulfilled for the Administration PC (Admin PC) that is used for initially setting up the system and for the subsequent administration of the communication system:

- Network interface:  
The admin PC requires an available LAN port.
- Operating system:  
Configuring the communication system with the Manager E is only possible on a Windows operating system (Windows XP and later).  
WBM configuration, however, is browser-based and therefore platform-independent.
- Web browser:  
The following web browsers are supported:
  - Microsoft Internet Explorer Version 10 and later.
  - Mozilla Firefox Version 17 and later.
  - Google Chrome

If an older version of the Web browser is installed, you will need to install an up-to-date version before you can start setting up the system.

- Oracle Java:  
The latest version of Oracle Java must be installed. If an older version is installed, you will need to update it to the latest version before you can start setting up the system.

## 4.2 Components

The various components of the installation example are described and outlined below.

The installation example includes the following components:

## Initial Setup for OpenScape Business X Components

- **OpenScape Business X**  
The communication system is integrated in the existing customer LAN via the LAN interface.
- **Admin PC**  
The admin PC is also connected to the communication system via a LAN interface.
- **IP stations (IP clients)**  
The IP stations (IP system phones, client PCs, WLAN Access Points, etc.) are integrated in the LAN via one or more switches.
- **UP0 stations**  
UP0 stations (e.g., OpenStage 60 T TDM system telephones) are connected directly to the communication system.
- **Analog stations**  
Analog stations (e.g., analog fax devices) are connected directly to the communication system.
- **DECT stations**  
DECT stations are logged on to the communication system via a base station.

The IP clients receive their IP addresses dynamically from an internal or external DHCP server (e.g., an Internet router).

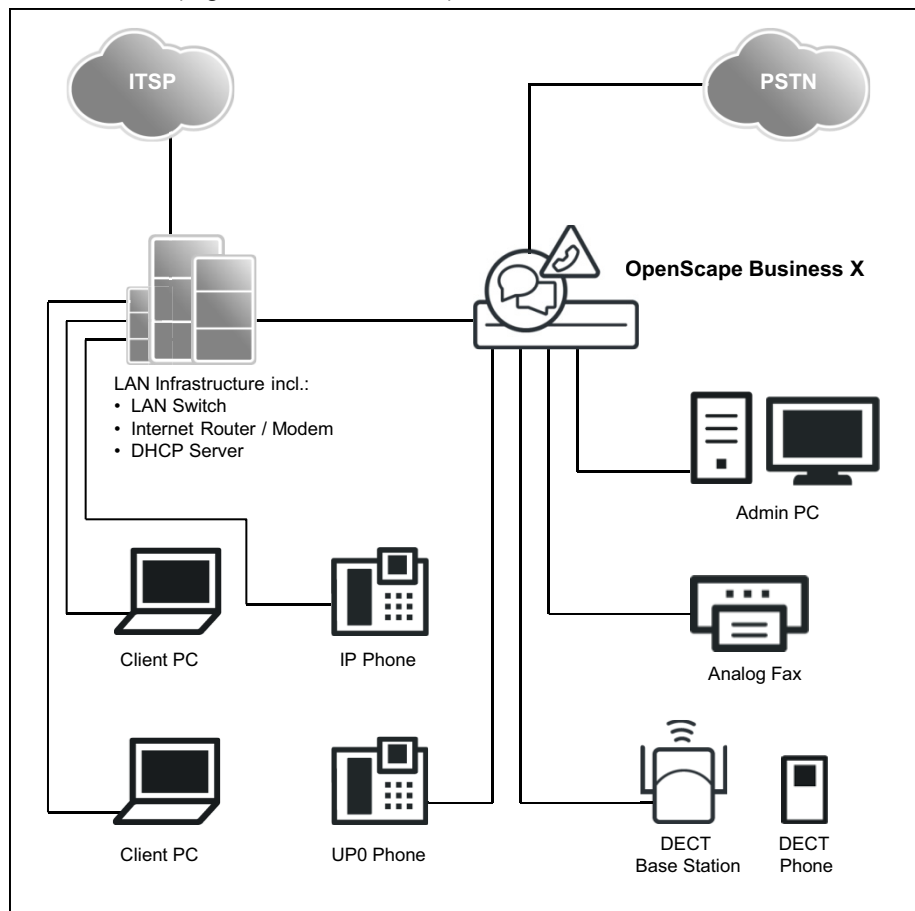

## 4.3 Dial Plan

A dial plan is a list of all phone numbers available in the communication system. It includes, among other things, the internal call numbers, DID numbers and group call numbers.

### Default Dial Plan

The internal call numbers are preassigned default values. These values can be adapted to suit individual requirements as needed (e.g., to create individual dial plans).

Extract from the default dial plan:

Type of call numbers	X1	X3/X5/X8
Internal station numbers	11-30	100-742
User direct inward dialing numbers	11-30	100-742
Trunk station number	700-703	from 7801 onward
Seizure codes (external codes):		
Trk. Grp 1 (trunk: ISDN, analog)	0 = World / 9 = USA	0 = World / 9 = USA
Rte. 8 (UC Suite)	-	851
Trk. Grp 12-15 (trunk: ITSP)	not preset	855-858
Rte. 16 (Networking)	not preset	859
Call number for remote access	not preset	not preset
Call number for voicemail		
UC Smart	351	351
UC Suite	-	not preset

### Individual Dial Plan

An individual dial plan can be imported via an XML file during basic configuration.

The XML file contains several tabs. Besides the names and phone numbers of subscribers, the "Customer" tab also includes additional subscriber data such as the subscriber types and e-mail addresses of the subscribers.

A sample XML file with the appropriate explanations can be found in the WBM under **Service Center > Documents > CSV Templates**. You can also use the XML file stored there as a template for your data. It can be edited with Microsoft Excel, for example.

## 4.4 IP Address Scheme

An IP address scheme is a definition of how the IP addresses are used in the customer LAN. It includes the IP addresses of PCs, servers, Internet routers, IP phones, the communication system, etc.

To provide a better overview of the assignment of IP addresses, an IP address scheme should be created.

Example of an IP address scheme with the IP address range 192.168.1." -x:

IP address range	Clients
<b>192.168.1.1 to 192.168.1.19</b>	Clients with a fixed IP address:
192.168.1.1	Internet router (gateway)
192.168.1.2	Communication system
192.168.1.3	Application Board (optional)
192.168.1.10	E-mail server
<b>192.168.1.50 to 192.168.1.254</b>	Client PCs & IP phones, also the IP address range of the DHCP server; IP addresses are assigned automatically to the clients

The following IP address ranges are internally reserved and must not be used:

Connected IP address ranges	Description
10.0.0.1; 10.0.0.2	Reserved for the license server
10.186.237.65; 10.186.237.66	Reserved for remote ISDN
192.168.3.2	Internal IP address of the communication system
192.168.2.1	IP address of the LAN3 port (Admin port)

This list can also be found in the WBM under **Service Center > Diagnostics > Status > Overview of IP Addresses**.

**Expanding the netmask when using the default network segment**

Both the internal IP address of the communication system and the IP address of the LAN3 port (Admin port) must not be in the same network segment as the IP address of the communication system.

Default network segment configuration:

- 192.168.1.2: IP address of the communication system
- 255.255.255.0: Netmask
- 192.168.3.2: Internal IP address of the communication system
- 192.168.2.1: IP address of the LAN3 port (Admin port)

If the netmask when using the default network segment of 255.255.255.0 was expanded to 255.255.0.0, for example, then the above IP addresses need to be changed:

Example of a modified configuration:

- 192.168.1.2: IP address of the communication system
- 255.255.0.0: Netmask

- 192.169.3.2: Internal IP address of the communication system  
The change is made via **Expert mode > Telephony > Payload > HW Modules > Edit DSP Settings**
- 192.170.2.1: IP address of the LAN3 port (Admin port)  
The change is made via **Expert mode > Telephony > Network Interfaces > Mainboard > LAN 3 (Admin)**

## 4.5 Initial Startup

Initial startup includes starting up the communication system, connecting and configuring the admin PC and starting the OpenScape Business Assistant (WBM) administration program for the first time.

The initial startup of the communication system must be performed prior to integrating the communication system into the internal LAN. Problems can occur if the pre-configured IP address of the communication system already exists in the internal LAN and/or if a DHCP server is already in use. In such cases, the IP address of the communication system must first be reconfigured and/or the DHCP server of the communication system must be deactivated. Only then can the communication system be integrated into the internal LAN.

---

**INFO:** Prior to initial startup, please follow the instructions on data protection and data security.

---



### DANGER

**OpenScape Business X8 may only be powered up if all system boxes are sealed at the rear with the connection and filler panels provided.**

---



### DANGER

**OpenScape Business X3/X5 must not be powered on unless the housing front is closed. Always use dummy panels (C39165-A7027-B115) to cover slots that are not equipped with boards.**

---



### DANGER

**The OpenScape Business X1/X3W/X5W must only be switched on when the housing is closed.**

---

### Connecting the admin PC

To configure the communication system, the admin PC is directly connected to the "LAN" interface of the communication system. The communication system is then configured to obtain its IP address from the internal DHCP server of the communication system. After successful installation, the admin PC can be integrated into the internal LAN without any further configuration changes.

## 4.5.1 How to Restart the Communication System

### Prerequisites

- The hardware was correctly installed (see *OpenScape Business Installation Guide*).
- The memory card (with the system software) was inserted.
- The communication system has not been integrated into the customer LAN yet.

### Step by Step

- › Connect the communication system to the power supply.



---

### WARNING

#### Risk of electric shock through contact with live wires

Make sure that the communication system (and for OpenScape Business X8, each system box) is grounded by a separate ground wire (see *OpenScape Business Installation Guide*).

---

The communication system is now started up, During this process, the system LEDs light up in different colors and sequences (see the *OpenScape Business Installation Guide* for details). During startup, the communication system must not be disconnected from the power supply.

After completion of the startup, the "Run" LED on the mainboard flashes green at 1Hz (0.5 sec on / 0.5 sec off).

## 4.5.2 How to Connect the Admin PC to the Communication System

### Prerequisites

- The communication system is ready for use.

### Step by Step

- 1) Start the admin PC.
- 2) Check whether a dynamic IP address can be assigned to the PC. If not, you will have to reconfigure the admin PC. To do this you must have Administrator rights.

---

**INFO:** The IP settings described here apply to Windows 7. For more detailed information on the configuration for other Windows operating systems, please refer to the appropriate operating system instructions.

---

- a) Select **Start > Control Panel**, double-click on **Network and Internet** and then click **Network and Sharing Center**.
  - b) Click on **LAN connection** for the appropriate active network and then click **Properties**.
  - c) On the **Networking** tab, use the left mouse button to select the **Internet Protocol Version 4(TCP/IPv4)** entry and then click on **Properties**.
  - d) Click on the **General** and ensure that the radio button **Obtain an IP address automatically** is enabled. If it is not, then activate it.
  - e) Close all open windows with **OK**.
- 3) Connect the just configured LAN port of the admin PC to the LAN port "LAN" of the communication system using a LAN cable. The admin PC is assigned a dynamic IP address via this interface.

---

**INFO:** You can also connect the admin PC to the LAN port "Admin" of the communication system, but you will then need to assign a fixed IP address in the range 192.168.2.xxx (e.g., 192.168.2.40) and the network mask 255.255.255.0 to the admin PC. The communication system has the IP address 192.168.2.1 via the LAN port "Admin" - important for WBM access!

---

### 4.5.3 How to Start the WBM

#### *Prerequisites*

- The communication system is ready for use. The "Run" LED on the mainboard flashes green at 1Hz (0.5 sec on / 0.5 sec off).
- The admin PC and the communication system can communicate with one another over the LAN.

#### *Step by Step*

- 1) Start the web browser on the admin PC and open the login page of the OpenScape Business Assistant (WBM) at the following address:

`https://192.168.1.2`

---

**INFO:** If the WBM cannot be started, check the LAN connection and repeat the call. If it still cannot be started, check whether the IP address has been blocked by your PC's internal firewall. More

detailed information can be found in the documentation of your  
firewall

---

- 2) If the browser reports a problem with a security certificate, install the certificate (using the example of Internet Explorer V10).
  - a) Close the web browser.
  - b) Open the web browser with administrator rights by clicking the right mouse button on the web browser icon and selecting the menu item **Run as administrator** from the context menu.
  - c) Allow the User Account Control.
  - d) Open the login page of the OpenScape Business Assistant (WBM) at the following address:  

```
https://192.168.1.2
```
  - e) Click on **Continue to this website**.
  - f) Click on the message **Certificate Error** in the navigation bar of the web browser.
  - g) Click on **View Certificates**.
  - h) Click on **Install Certificate** (only visible with administrator rights).
  - i) Select the option **Local Computer** and confirm with **Next**.
  - j) Select the option **Place all certificates in the following store**, click **Browse** and specify **Trusted Root Certification Authorities**.
  - k) Confirm with **OK** and then with **Next** and **Finish**.
  - l) Confirm the certificate import with **OK** and close the certificate window **OK**.
  - m) Close the web browser.
  - n) Start the web browser again (without administrator rights) and open the login page of the OpenScape Business Assistant (WBM) at the following address:  

```
https://192.168.1.2
```
- 3) Click on the language code at the top right and select the language in which the user interface of the WBM is to be displayed from the menu. The Login page will be displayed in the selected language.
- 4) In the field under **Login**, enter the default user name `administrator@system` for access as an administrator.

---

**INFO:** If you go to the **Password** field after entering `administrator, @system` will be added automatically.

---

- 5) In the second field under **Login**, enter the default password `administrator` for access as an administrator.
- 6) Click **Login**.



- 7) The following steps are only required once when first logging on to the WBM:
- a) Reenter the default password **administrator** in the `Password` field.
  - b) Enter a new password in the **New Password** and **Confirm New Password** fields to protect the system against misuse. Note case usage and the status of the `Num` und `CapsLock` keys. The password is displayed as a string of asterisks (\*).

---

**INFO:** The password must be at least 8 characters long and include a digit. Make sure that you remember your new password.

---

- c) Click **Login**.
- d) Select the current date and enter the correct time.
- e) Click **OK & Next**. You are automatically logged out of the WBM.
- f) In the field under **Login**, enter the default user name `administrator@system` for access as an administrator.

---

**INFO:** If you go to the **Password** field after entering `administrator, @system` will be added automatically.

---

- g) In the second field under **Login**, enter your new password for access as an administrator.
- h) Click **Login**. The home page of the WBM appears.

### **Next steps**

Start the initial installation.

## **4.6 Integration into the Customer LAN**

The WBM wizard **Initial Installation** is used for integration into the customer LAN. This wizard guides you through the basic settings for integrating the communication system into the existing LAN.

### **4.6.1 How to Start the Initial Installation Wizard**

#### **Prerequisites**

- The WBM has been started.

#### **Step by Step**

- 1) In the navigation bar, click on **Setup**.
- 2) Click on **Edit** to start the **Initial Installation** wizard.

---

**INFO:** If the size of the browser window cannot display the workspace in its entirety at low screen resolutions, a horizontal or vertical scroll bar appears at the sides and can be used to scroll to the required section.

---

### **Next steps**

Perform initial installation as described in the following step-by-step instructions. Fields that are not described here are preset for the default scenario and should only be changed if they are not appropriate for your network data. For detailed information, refer to the descriptions provided in the Administrator documentation for the individual wizards.

## **4.6.2 System Settings**

The **System Settings** window is used to configure the system settings of the communication system.

Proceed as follows:

1. Set the display logo and the product name  
Specify a display text to be displayed on the display of the system phones. Additionally, you can also select the product name.
2. Edit IP addresses (if required)  
By default, the communication system is assigned an IP address and a subnet mask. You may need to adjust the IP address and/or subnet mask to your own IP address range.  
In addition, you can specify the IP address of your default router, e.g., the IP address of the Internet router.  
The Application Board (UC Booster Card) also requires an IP address. You can assign an IP address from your IP address range regardless of whether or not the board is installed.

If the netmask is to be expanded, e.g., from 255.255.255.0 to 255.255.0.0, both the internal IP address of the communication system and the IP address of the LAN3 port (Admin port) must be changed because they are not allowed to be in the same network segment as the IP address of the communication system (see also [IP Address Scheme](#)).

### **4.6.2.1 How to Set the Display Logo and the Product Name**

#### **Prerequisites**

- You are in the **System Settings** window.

The screenshot shows the 'System Settings' window. At the top, there are two fields: 'Display Logo' with the value 'OpenScope Biz' and 'Brand' with a dropdown menu set to 'OpenScope Business'. Below this, there are two sections: 'OpenScope Business' and 'Application board'. The 'OpenScope Business' section contains four fields: 'OpenScope Business - IP address' (192.168.1.2), 'OpenScope Business - Netmask' (255.255.255.0), 'OpenScope Business - Default Routing via' (LAN), and 'OpenScope Business - IP Address of Default Router' (192.168.1.1). The 'Application board' section contains three fields: 'Application board - IP address' (192.168.1.3), 'Application board - Netmask' (255.255.255.0), and 'Application board - IP Address of Default Router' (192.168.1.1). A red box highlights the 'Display Logo' and 'Brand' fields in the first image, and the 'OpenScope Business' section fields in the second image.

### Step by Step

- 1) In the **Display Logo** field, enter a text of your choice (e.g., OpenScope Biz). The text can contain up to 16 characters. Avoid the use of diacritical characters such as umlauts and special characters.
- 2) Select the desired time product name in the **Brand** drop-down list.

### Next steps

Edit IP addresses (if required) or configure DHCP.

## 4.6.2.2 How to Specify the IP Addresses (Optional)

### Prerequisites

- You know the IP address range of your internal network.
- You are in the **System Settings** window.

This screenshot is identical to the one above, but with a red box highlighting the 'OpenScope Business' section fields: 'OpenScope Business - IP address', 'OpenScope Business - Netmask', 'OpenScope Business - Default Routing via', and 'OpenScope Business - IP Address of Default Router'.

### Step by Step

- 1) Specify the IP address of the communication system:
  - a) In the field **OpenScope Business - IP address**, enter an IP address that lies within the IP address range of your internal network (e.g., internal network: 192.168.1.x, OpenScope Business: 192.168.1.2).

---

**INFO:** The IP address for OpenScape Business must not be assigned to any other existing network client, since this would result in an IP address conflict.

---

- b) Enter the subnet mask of your internal network (e.g., 255.255.255.0) in the **OpenScape Business - Subnet Mask** field.
- 2) Specify the IP address of the default router:
  - a) In the **OpenScape Business - Default Routing via** field, select the entry **LAN**.
  - b) Enter the IP address of your default router in the **OpenScape Business - IP Address of Default Router** field (e.g., internal network: 192.168.1.x, Internet router as default router: 192.168.1.1).
- 3) Specify the IP address of the UC Booster Card (required if installed):
  - a) In the field **UC Booster Card - IP address**, enter an IP address that lies within the IP address range of your internal network (e.g., internal network: 192.168.1.x, UC Booster Card: 192.168.1.3).

---

**INFO:** The IP address of the UC Booster Card must not be assigned to any other existing network client, since this would result in an IP address conflict.

---

- 4) Click on **OK & Next**.

### **Next steps**

Configure DHCP.

## **4.6.2.3 How to Specify the Device Name**

### **Prerequisites**

- You are in the **System Settings** window.
- System is in DTAG mode.

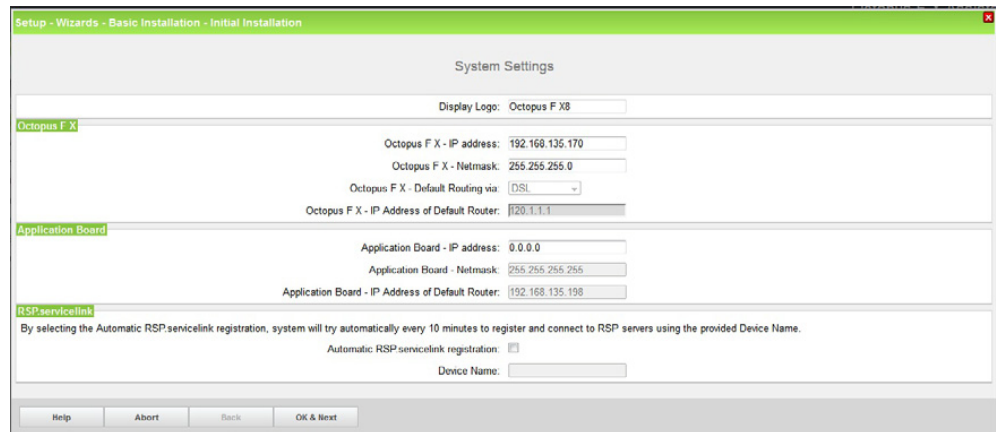

### Step by Step

- 1) Check the **Automatic RSP.servicelink registration** checkbox:

**Device Name** field is editable.

- 2) Specify the **Device Name**.

By selecting the Automatic RSP.servicelink registration, system will try automatically every 10 minutes to register and connect to RSP servers using the provided Device Name.

- 3) Click on **OK & Next**.

### Next steps

Configure DHCP.

## 4.6.3 DHCP Settings

In the window **DHCP global settings** enable and configure or disable the internal DHCP server of the communication system.

A DHCP server automatically assigns a unique IP address to each IP station (IP system phones, PCs, etc.) and provides the IP stations with network-specific data such as the IP address of the default gateway (Internet router), for example.

The DHCP server can be an external DHCP server (e.g., the DHCP server of the Internet router) or the internal DHCP Server of the Linux server integrated into the communication system.

Either the integrated DLI of the communication system or an external DLS server can be used for automatically updating the software of the IP system phones (*Deployment Service (DLS and DLI)*). The IP address of the integrated DLI or the external DLS server must be known to the DHCP server.

You have the following options:

- Enable and configure the internal DHCP server  
If the internal DHCP server of the communication system is used, an external DHCP server (e.g., the DHCP server of the Internet router) must be

deactivated. The settings of the internal DHCP server may have to be adapted to the customer LAN. If the internal DHCP server and the internal DLI are used, the system phones are updated automatically. If an external DLS server is used, its IP address must be entered in the internal DHCP server using Expert mode ([Deployment Service \(DLS and DLI\)](#)).

- Disable the internal DHCP server  
If an external DHCP server is used, the internal DHCP server of the communication system must be disabled. For IP system phones to be automatically supplied with the latest phone software, network-specific data (such as the IP address of the internal DLI or the external DLS server) must be specified on the external DHCP server.

---

**INFO:** Not all external DHCP servers support the entry of network-specific data! In this case, the data must be entered manually on all IP system phones.

---

#### 4.6.3.1 How to Disable the Internal DHCP Server

##### *Prerequisites*

- An external DHCP server (e.g., the DHCP server of the Internet router) is enabled in the internal network.
- You are in the **DHCP Global Settings** window.

##### *Step by Step*

- 1) Clear the **Enable DHCP Server** check box.
- 2) Click on **OK & Next**.

##### *Next steps*

Configure country and time settings.

#### 4.6.3.2 How to Enable and Configure the Internal DHCP Server

##### *Prerequisites*

- The external DHCP server (e.g., the DHCP server of the Internet router) has been disabled in the internal network.
- You are in the **DHCP Global Settings** window.

DHCP Global Settings	
Enable DHCP Server:	<input checked="" type="checkbox"/>
Netmask:	255.255.255.0
Broadcast Address:	0.0.0.0 (optional)
<b>Default Gateway</b>	Preferred Gateway: 192.168.1.1
<b>DNS Server</b>	Domain Name: <input type="text"/>
	Preferred Server: 192.168.1.1
	Lease time in hours (0 infinite): 1
	Enable Dynamic DNS Update: <input type="checkbox"/>

### Step by Step

- 1) Leave the **Enable DHCP Server** check box enabled.
- 2) Go to the **Netmask** field and adjust the subnet mask to your IP address range (for example, 255.255.255.0).
- 3) In the field **Preferred Gateway**, enter the IP address of the Internet router (e.g., 192.168.1.1).
- 4) In the field **Preferred Server**, enter the IP address of the DNS server (e.g., the IP address of the Internet router, 192.168.1.1).
- 5) Click on **OK & Next**. The **DHCP Address Pool** window appears.

DHCP Address Pool	
Subnet address:	192.168.1.0
Subnet mask:	255.255.255.0
<b>Address range</b>	Address range 1: 192.168.1.50 - 192.168.1.254

- 6) Specify the values for **Subnet address**, **Netmask** and **Address range 1** in order to define the IP address range to be managed by the internal DHCP server.

If the internal network uses static IP addresses (e.g., for a printer server), the IP address range (DHCP address pool) must be selected so that the fixed IP addresses are not included within this range.

Example:

Internet router: 192.168.1.1

OpenScape Business: 192.168.1.2

UC Booster Card: 192.168.1.3

Subnet address: 192.168.1.0

Subnet mask: 255.255.255.0

Printer Server: 192.168.1.10

DHCP address pool: 192.168.1.50 to 192.168.1.254

- 7) Click on **OK & Next**.

### Next steps

Configure country and time settings.

## 4.6.4 Country and Time Settings

In the **Basic Configuration** window, select your country and the language for the event logs and set the date and time. If you are using the integrated Cordless solution, enter the system-wide DECT system ID here.

Proceed as follows:

1. Select the country code and the language to be used for event logs  
For country initialization to work correctly, you must select the country in which the communication system is operated. In addition, you can select the language in which the event logs (system event logs, errors logs, etc.) are to be stored.
2. Enter the DECT system identification (only for integrated Cordless solution)  
If you are using the integrated Cordless solution, enter the system-wide DECT system ID here.
3. Setting Date and Time
  - How to Set the Date and Time Manually  
The communication system and the stations (IP phones, TDM phones, client PCs) should have a uniform time base (date and time). If no SNTP server has been specified for time synchronization, the date and time can also be entered manually.

---

**INFO:** The date and time are also updated when a connection is set up via an ISDN trunk.

---

- How to Obtain the Date and Time from an SNTP Server  
The communication system and IP stations (IP phones, client PCs) should have a uniform time base (date and time). This time base can be provided by an SNTP server. The SNTP server can be located on the internal network or the Internet.

The IP phones receive the date and time automatically from the communication system. The client PCs on which the UC clients run must be set so that they are synchronized with the communication system (see the operating system instructions for the client PCs).

### 4.6.4.1 How to Select the Country Code and the Language for Event Logs

#### *Prerequisites*

- You are in the **Basic Configuration** window.



The screenshot shows the 'Basic Configuration' window with the following settings:

- Language settings:** System Country Code: Germany (dropdown), Language for Customer Trace Log: English (dropdown). These two fields are highlighted with a red box.
- Time settings:** Date and Time: Day: 19, Month: 12, Year: 2013, hh:mm:ss: 13:45:40. Timezone: (GMT +01:00) Berlin, Rome, Stockholm, Vienna (dropdown).
- Detect date and time via an SNTP server:** Date and Time via an external SNTP Server:
- CMI data:** System ID: 00000000

### Step by Step

- 1) In the **System Country Code** drop-down list, select the country where the communication system is operated.
- 2) In the **Language for Customer Event Log** field, enter the language in which the event logs (system event logs, error logs, etc.) are to be output.

### Next steps

Enter the DECT system identification (only for integrated Cordless solution)  
or  
Set the date and time manually or obtain the date and time from an SNTP server.

## 4.6.4.2 How to Enter the DECT System ID

### Prerequisites

- You are in the **Basic Configuration** window.

The screenshot shows the 'Basic Configuration' window with the following settings:

- Language settings:** System Country Code: Germany (dropdown), Language for Customer Trace Log: English (dropdown).
- Time settings:** Date and Time: Day: 19, Month: 12, Year: 2013, hh:mm:ss: 13:45:40. Timezone: (GMT +01:00) Berlin, Rome, Stockholm, Vienna (dropdown).
- Detect date and time via an SNTP server:** Date and Time via an external SNTP Server:
- CMI data:** System ID: 00000000. This field is highlighted with a red box.

### Step by Step

- › In the **CMI data** area under **System ID**, enter the 8-digit hexadecimal DECT system ID that you received on purchasing your integrated Cordless solution.

### Next steps

Set the date and time manually or obtain the date and time from an SNTP server.

### 4.6.4.3 How to Set the Date and Time Manually

#### Prerequisites

- You are in the **Basic Configuration** window.

The screenshot shows the 'Basic Configuration' window with several sections. The 'Language settings' section includes 'System Country Code' (Germany) and 'Language for Customer Trace Log' (English). The 'Time settings' section is highlighted with a red box and contains 'Date and Time' (Day: 19, Month: 12, Year: 2013, hh:mm:ss: 13:45:40) and 'Timezone' ((GMT +01:00) Berlin, Rome, Stockholm, Vienna). Below this is the 'Detect date and time via an SNTP server' section with a checkbox for 'Date and Time via an external SNTP Server'. The 'CMI data' section shows 'System ID: 00000000'.

#### Step by Step

- 1) Enter the current values for **Date and Time**.
- 2) Select the desired time zone in the **Timezone** field.
- 3) Click on **OK & Next**.

---

**NOTICE:** In case the Timezone setting is changed, then at the last step of Initial Wizard **the system will be restarted**.  
If Timezone setting remain untouched then system will not be restarted.

---

#### Next steps

Specify UC solution.

### 4.6.4.4 How to Obtain the Date and Time from an SNTP Server

#### Prerequisites

- You are in the **Basic Configuration** window.

Basic Configuration

Language settings

System Country Code: Germany

Language for Customer Trace Log: English

Time settings

Date and Time: Day: 19, Month: 12, Year: 2013, hh:mm:ss: 13:45:40

Timezone: (GMT +01:00) Berlin, Rome, Stockholm, Vienna

Detect date and time via an SNTP server

Date and Time via an external SNTP Server:

IP Address / DNS Name of External Time Server: 0.de.pool.ntp.org

Poll Interval for External Time Server: 4 hours

CMI data

System ID: 00000000

### Step by Step

- 1) Select the **Date and Time via an external SNTP Server** check box.
- 2) Enter the IP address or the DNS name of the SNTP server (e.g., `0.de.pool.ntp.org`) in the **IP Address / DNS Name of External Time Server** field).
- 3) From the drop-down list **Poll Interval for External Time Server**, select after how many hours the Date and Time should be synchronized by the SNTP Server (recommended value: 4 h).
- 4) Click on **OK & Next**.

### Next steps

Specify UC solution.

## 4.6.5 UC Solution

In the **Change application selection** window, select the UC solution to be used.

You have the following options:

- **Package with UC Smart**  
The UC solution UC Smart is integrated on the OpenScope Business X mainboard.
- **Package with UC Suite**  
The UC solution UC Suite is integrated on the additional internally pluggable "UC Booster Card".
- **Package with UC Suite on OSBiz UC Booster Server**  
The UC solution UC Smart is integrated on the external Linux server "OpenScope Business UC Booster Server".
- **Package with UC Suite on OSBiz UC Booster Server**  
The UC solution UC Suite is integrated on the external Linux server "OpenScope Business UC Booster Server".

### 4.6.5.1 How to Define the UC Solution

#### Prerequisites

- You have purchased licenses for either of the UC solutions, UC Smart or UC Suite.
- You are in the **Change application selection** window.

The screenshot shows a window titled "Application Selection" with the following content:

Select application packages	
Package with UC Smart:	<input type="radio"/>
Package with UC Suite:	<input checked="" type="radio"/>
Package with UC Smart on OSBiz UC Booster Server:	<input type="radio"/>
Package with UC Suite on OSBiz UC Booster Server:	<input type="radio"/>

Application Selection	
UC Smart:	-
Application Launcher:	192.168.1.4
CSTA Connector:	192.168.1.4
OpenDirectory Service:	192.168.1.4
UC Suite / XMPP:	192.168.1.4
Gate View:	192.168.1.4
Web Collaboration:	*IDemo Mode

**Note:**  
The Package with UC Smart also activates CSTA and other applications on the UC Booster Card.  
Please refer to the online help for details.

#### Step by Step

- 1) If you are using the UC solution UC Smart without a UC Booster Server, click **Package with UC Smart**.
- 2) If you are using the UC solution UC Smart with the UC Booster Server, click on **Package with UC Smart on OSBiz UC Booster Server**. In addition, enter the IP address of the external Linux server "OpenScape Business UC Booster Server" in the **IP address of OSBiz UC Booster Server** field.
- 3) If you want to use the UC solution UC Suite with the UC Booster Card, click on **Package with UC Suite**.
- 4) If you are using the UC solution UC Suite with the UC Booster Server, click on **Package with UC Suite on OSBiz UC Booster Server**. In addition, enter the IP address of the external Linux server "OpenScape Business UC Booster Server" in the **IP address of OSBiz UC Booster Server** field.
- 5) Click on **OK & Next**.
- 6) The **Initial installation** wizard is closed. Click **Finish**.
- 7) Exit the WBM by right-clicking the **Logout** link on the top right of the screen and then close the window.

---

**INFO:** If IP addresses or DHCP server settings have been changed, the communication system performs a restart. This can take a few minutes.

---

### **Next steps**

Connect the communication system to the customer LAN.

## **4.6.6 Connecting the Communication System to the Customer LAN**

After a successful initial installation, the communication system is connected to the existing customer LAN.

### **4.6.6.1 How to Connect the Communication System to the Customer LAN**

#### **Prerequisites**

- The communication system is ready for use.

#### **Step by Step**

- 1) Remove the LAN cable of the admin PC from the central LAN port "LAN" and integrate the admin PC in the customer's LAN by connecting it to a switch, for example.
- 2) Connect a LAN cable to the middle "LAN" port of the communication system.
- 3) Integrate the communication system via this LAN cable in the customer LAN by connecting it to a switch, for example.
- 4) If a UC Booster Card (Application Board) is plugged in, connect another LAN cable to the "LAN2" port of the UC Booster Card (right/lower of the two LAN interfaces) and integrate the UC Booster Card via this LAN cable in the customer LAN by connecting it to a switch, for example.

#### **Next steps**

Start the basic configuration.

## **4.7 Basic Configuration**

The **Basic Installation** wizard is used for basic configuration. Basic configuration includes the most important settings for operating the communication system.

The Basic Installation Wizard includes a progress indicator showing the current step, as well as the steps that follow.

## 4.7.1 How to Start the Basic Installation Wizard

### Prerequisites

- The **Initial installation** has been completed.
- The communication system is integrated in the customer LAN
- The communication system is ready for use. The "Run" LED on the mainboard flashes green at 1Hz (0.5 sec on / 0.5 sec off).

### Step by Step

- 1) Open the WBM login page on the admin PC by entering the following address in your web browser:

`https://<IP address of OpenScape Business>`

The default IP address for OpenScape Business is 192.168.1.2, i.e., `https://192.168.1.2`, for example.

- 2) In the **User Name** field, enter the default user name `administrator@system` for access as an administrator.
- 3) Enter the password you defined at initial startup in the **Password** field.
- 4) Click on **Login**.
- 5) In the navigation bar, click on **Setup**.
- 6) Click on **Edit** to start the **Basic Installation** wizard.

### Next steps

Perform basic installation as described in the following step-by-step instructions. Fields that are not described here are preset for the default scenario and should only be changed if they are not appropriate for your network data. For detailed information, refer to the descriptions provided in the Administrator documentation for the individual wizards.

## 4.7.2 System Phone Numbers and Networking

Enter the system phone numbers (PABX number, country and area code, international prefix) in the **Overview** window and specify whether OpenScape Business is to be networked with other OpenScape Business systems.

Proceed as follows:

1. Enter system phone numbers

- Enter system phone numbers for point-to-point connection  
Here you enter the system phone number for your point-to-point connection and the country code and area code.  
The entry of the country code is mandatory for Internet telephony and conference server functionality.  
The international prefix is preset, depending on the previously dialed country code.
  - Enter system phone numbers for point-to-multipoint connection  
Here you enter the country code and area code for your point-to-multipoint connection.  
The entry of the country code is mandatory for Internet telephony and Meet-Me conferences.  
The international prefix is preset, depending on the previously dialed country code.
2. Activate or deactivate networking  
If OpenScape Business is to be networked with other OpenScape Business systems, networking must be enabled, and OpenScape Business must be assigned a node ID. Every OpenScape Business must have a unique node ID in the network.

#### 4.7.2.1 How to Enter the System Phone Numbers for a Point-to-Point connection

##### Prerequisites

- You have a point-to-point connection.
- You are in the **Summary** window.

Overview

Note: At least the configuration of the 'Country code' is needed for features such as 'Internet telephony' and 'MeetMe conference'.  
If you want your OpenScape Business in "OpenScape Business Network Integration" you should select the "Network Integration" check box and enter a node ID. In this case, make sure that this node ID is unique within the whole network integration.  
Normally, this integration is done by a Service Technician.  
For a standalone OpenScape Business clear the 'Network Integration' check box.

**PABX number**

Country code: 49 (mandatory)  
Local area code: 89 (optional)  
PABX number: 7007 (optional)

**General**

International Prefix: 00

**Network Parameters**

Network Integration:   
Node ID: 0

##### Step by Step

- 1) In the **Country Code** field, enter the country code prefix, e.g., 49 for Germany or 1 for the U.S.
- 2) Enter the local area code, e.g., 89 for Munich, in the **Local area code** field.
- 3) Enter the system phone number of your trunk connection, e.g., 7007 (your connection number), in the **PABX number** field.

- 4) Change the **International Prefix** field only if required. The applicable values for Germany and the United States are 00 and 011, respectively.

For international calls, the phone number is preceded by the international prefix and the country code, e.g., "00-1-..." for calls from Germany to the USA and "011-49-..." for calls from the USA to Germany.

**Next steps**

Activate or deactivate networking

### 4.7.2.2 How to Enter the System Phone Numbers for a Point-to-Multipoint Connection

**Prerequisites**

- You have a point-to-multipoint connection.
- You are in the **Summary** window.

The screenshot shows a configuration window titled 'Overview'. It contains a note about 'Country code' configuration and a section for 'PABX number' with the following fields:

- Country code: 49 (mandatory)
- Local area code: 89 (optional)
- PABX number: (optional)
- International Prefix: 00

Below these fields are sections for 'General' and 'Network Parameters', with the latter containing 'Network Integration' (checkbox) and 'Node ID: 0'.

**Step by Step**

- 1) In the **Country Code** field, enter the country code prefix, e.g., 49 for Germany or 1 for the U.S.
- 2) Enter the local area code, e.g., 89 for Munich, in the **Local area code** field.
- 3) Leave the **PABX number** field empty.
- 4) Change the **International Prefix** field only if required. The applicable values for Germany and the United States are 00 and 011, respectively.

For international calls, the phone number is preceded by the international prefix and the country code, e.g., "00-1-..." for calls from Germany to the USA and "011-49-..." for calls from the USA to Germany.

**Next steps**

Activate or deactivate networking



### 4.7.2.3 How to Activate or Deactivate Networking

#### Prerequisites

- You are in the **Summary** window.

The screenshot shows the 'Overview' window of the configuration tool. It contains a note about country code configuration, a 'PABX number' section with fields for Country code (49), Local area code (89), and PABX number (7007), a 'General' section with an International Prefix (00), and a 'Network Parameters' section with a checked 'Network Integration' checkbox and a 'Node ID' field containing the value 1. A red box highlights the 'Network Integration' checkbox and the 'Node ID' field.

#### Step by Step

- If the communication system is to be networked with other communication systems:
  - Select the **Network Integration** check box.
  - In the **Node ID** field for the communication system, enter a node ID that is unique in the internetwork (digits from 1 through 100 are possible).
- If the communication system is not to be networked with other communication systems, leave the **Network Integration** check box disabled.

#### Next steps

Configure the upstream of your Internet connection.

### 4.7.3 Station Data

If necessary, you can configure your own individual dial plan instead of the predefined default dial plan in the **Central Functions for Stations** window and import additional station data. In an internetwork, the default dial plan must be adapted to the dial plan of the internetwork.

The default dial plan contains predefined numbers for different types of stations (IP phones, analog phones, ...) and for special functions (Internet telephony, voicemail box, AutoAttendant, ...).

The station data includes the internal call numbers, DID numbers and names of the stations. This data and other station data can be imported into the communication system during the basic configuration via an XML file in UTF-8 format.

---

**INFO:** An XML template with the appropriate explanations can be found in the WBM under **Service Center > Documents > CSV Templates**. You can enter your data in this template by using Microsoft Excel, for example.

---

You have the following options:

- **Configure station data without an internetwork**

Proceed as follows:

- a) Display the station data  
You can have all preconfigured station numbers and station data displayed.
- b) Delete all station numbers (optional)  
If you use an individual dial plan, you must delete all preconfigured station numbers.
- c) Adapt preconfigured station numbers for the individual dial plan (optional)  
If you are using an individual dial plan, you can adapt the preconfigured phone numbers to your own dial plan.

---

**INFO:** If the user passes through the **Change preconfigured functional call numbers**, any existing custom configuration done in UC Suite must be reviewed or repeated (e.g., pilot queues)

---

- d) Import station data from an XML file (optional)  
You can easily import your individual station numbers, including any additional station data, during the basic configuration via an XML file.

- **Configure station data with an internetwork**

Proceed as follows:

- a) Delete all station numbers  
If the UC Suite is used in an internetwork, a closed numbering plan is required, i.e., all station numbers in the internetwork must be unique. For this reason, any preconfigured station numbers must be deleted and only stations numbers adapted for the internetwork must be used.
- b) Import station data from an XML file  
The station numbers adapted for the internetwork and any additional station data can be easily imported during the basic configuration via an XML file. This file can contain all stations in the internetwork. During import, only the station numbers and the station data assigned to the previously specified node ID of the communication system will be transferred.

### 4.7.3.1 How to Display the Station Data

#### Prerequisites

- You are in the **Central Functions for Stations** window.

#### Step by Step

- 1) Select the **Display stations configuration** radio button.
- 2) Click on **Execute function**. A list of stations with the preconfigured phone numbers (default dial plan) is displayed.
- 3) Click on **OK**. You are taken back to the **Central Functions for Stations** window.
- 4) If you do not want to change any station data, click **OK & Next**.

### 4.7.3.2 How to Delete all Call Numbers

#### Prerequisites

- You are in the **Central Functions for Stations** window.

#### Step by Step

- 1) Enable the radio button **Delete all station call numbers**.
- 2) Enable the check box **Delete All Call Addresses**.
- 3) Click on **Execute function**. All preset call numbers are deleted. The **Change preconfigured call and functional numbers** window then appears.

Change preconfigured call and functional numbers				
• Please keep in mind, that these numbers are not available for station or group dialing use.				
Preconfiguration for Internet Telephony	855	856	857	858
Integrated Voicemail call number (IVM)	350			
Voicemail call number (Smart VM)	351			
Autoattendant call number (Smart VM)	352			
Attendant code	9			
Remote Admin call number	-			
Licensing call number	-			

- 4) Adjust the codes and special call numbers to suit your preferences, and then click **OK**. You are taken back to the **Central Functions for Stations** window.
- 5) If you do not want to change any further station data, click **OK & Next**.

### 4.7.3.3 How to Adapt Preconfigured Station Numbers for the Individual Dial Plan

#### Prerequisites

- You are in the **Central Functions for Stations** window.

#### Step by Step

- 1) Enable the radio button **Change pre-configured call and functional numbers**.
- 2) Click on **Execute function**. The **Change preconfigured call and functional numbers** window appears.

Change preconfigured call and functional numbers				
• Please keep in mind, that these numbers are not available for station or group dialing use.				
Preconfiguration for Internet Telephony	855	856	857	858
Integrated Voicemail call number (IVM)	350			
Voicemail call number (Smart VM)	351			
Autoattendant call number (Smart VM)	352			
Attendant code	9			
Remote Admin call number	-			
Licensing call number	-			

- 3) Adjust the preconfigured call numbers to suit your preferences, and then click **OK**. You are taken back to the **Central Functions for Stations** window.
- 4) If you do not want to change any further station data, click **OK & Next**.

### 4.7.3.4 How to Import the Station Data from an XML File

#### Prerequisites

- You are in the **Central Functions for Stations** window.
- An XML file with the entered data is available in UTF-8 format. An XML template can be found under **Service Center > Documents > CSV Templates**.

#### Step by Step

- 1) Enable the radio button **Import XML file with station data**.
- 2) Click **Execute function**.
- 3) Use **Browse** to select the created XML file and click **Open**.
- 4) Click **OK** when finished. The station data is imported.
- 5) Click **OK & Next**.

### 4.7.3.5 How to display Mass data

#### *Prerequisites*

- You are in the **Central Functions for Stations** window.

#### *Step by Step*

- 1) Enable the **Mass Data wizard** button.
- 2) Click on **Execute function**.
- 3) In the **Mass Data Wizard** window you can validate the entries of the system, by clicking on **Validate**. There are two types of validation, the Front End Consistency Check and the Back End Consistency Check.

The green color in validation field indicates only the actions that have been recently validated. The validation of data is not saved, so if the values are changed the user has to validate again the data.

- 4) During Back End Consistency Check and after the successful validation of data no editing in **Mass Data Wizard** window is possible. After the successful validation **OK&Next** becomes available with Edit restrict mode. If the user clicks on **Back**, Edit mode becomes available but **OK&Next** disappears. When the validation is unsuccessful Edit mode remains intact and **OK&Next** stays hidden.

---

**INFO:** The user can click on **Back** to re-edit the data and the window returns to Edit mode again. The Edit restrict mode ensures that the user cannot click on OK&Next and submit changes that are not validated.

---

- 5) When **Mass Data Wizard** is configured successfully click on **Finish**. In the finish page is displayed a sum up with all the changes.

Fields that are not editable are already filled in with the relevant values obtained by the Database. As a result Copy/paste function will have no effect in data.

Type field is a selectable drop down menu with editing functionality. However the only options accepted are No Port, System Client, SIP Client, Deskshare User and potentially a predefined value based on the Baugruppe it belongs. If the user tries to enter something else then this will not be accepted and drop down menu will not be disappear persisting in providing a proper entry.

Another restriction is that some ports are not changeable (for instance ports belonging in an Analog card, type is not changeable and should remain Analog Station). All restrictions apply when the user tries to perform copy paste on top of Type column. If the user tries to paste irrelevant data not compromising with the rules above paste will not be performed at all.

Copy and paste can be applied on the whole table as well as on specific parts.

---

**INFO:** When selecting two following cells, with a numeric value, and you pull down the fields the following columns are not filled in

with ascending numbers but they are filled in with a copy of the selected cells.

---

## 4.7.4 ISDN Configuration

In the **ISDN Configuration** window, you specify whether ISDN stations are to be connected and whether ISDN is to be used for the trunk connection. The ISDN trunk connection can be set up as an ISDN point-to-point connection and/or an ISDN-point-to-multipoint connection. Depending on the communication system and board used, different S<sub>0</sub> ports are available for this purpose.

You have the following options:

- Enable ISDN configuration:
  - a) Configure an ISDN point-to-point connection  
You can set up an ISDN trunk connection as a point-to-point connection with DID numbers.
  - b) Configure an ISDN point-to-multipoint connection  
You can set up an ISDN trunk connection as a point-to-multipoint connection with MSN.
  - c) Set up a connection for ISDN subscribers (optional)  
One or more S<sub>0</sub> interfaces can be configured as internal S<sub>0</sub> connections in order to connect ISDN stations (ISDN phones or ISDN fax devices). A station license is required for each ISDN station.
- Disable ISDN configuration  
If you do not have an ISDN trunk connection, you must disable the ISDN configuration. All S<sub>0</sub> interfaces automatically configured as internal S<sub>0</sub>ports.

### Other options for trunk connections

Instead of setting up an ISDN trunk connection, you can also set up an analog trunk connection or a trunk connection through an Internet Telephony Service Provider (ITSP, SIP provider). Basic installation must be complete before the analog trunk connection can be configured.

### 4.7.4.1 How to Configure the Connection of ISDN Stations

#### Prerequisites

- You are in the **ISDN Configuration** window.

The screenshot shows the 'ISDN Configuration' window. At the top, there is a checkbox labeled 'No call via ISDN trunk line (S0)'. Below this is a table with the following columns: 'Box', 'Slot', 'S0-Port', 'Board Type', 'Point-to-point connection', 'Point-to-multipoint connection', 'Internal S0 connection', and 'Settings configured in expert mode'. The table contains two rows of data. The first row has Box 1, Slot 1, S0-Port 1, Board Type STLS2N, and the 'Point-to-point connection' radio button is selected. The second row has Box 1, Slot 1, S0-Port 2, Board Type STLS2N, and the 'Internal S0 connection' radio button is selected. A red rectangular box highlights the 'Internal S0 connection' column.

Box	Slot	S0-Port	Board Type	Point-to-point connection	Point-to-multipoint connection	Internal S0 connection	Settings configured in expert mode
1	1	1	STLS2N	<input checked="" type="radio"/>	<input type="radio"/>	<input type="radio"/>	
1	1	2	STLS2N	<input type="radio"/>	<input type="radio"/>	<input checked="" type="radio"/>	

### Step by Step

- 1) Clear the check box **No call via ISDN trunk line (S0)**.
- 2) Activate the **Internal S0 connection** radio button for the desired S<sub>0</sub> port.

### Next steps

Configure ISDN point-to-point connection and/or configure ISDN point-to-multipoint connection.

## 4.7.4.2 How to Configure the ISDN Point-to-Point Connection

### Prerequisites

- You are in the **ISDN Configuration** window.

Box	Slot	S0-Port	Board Type	Point-to-point connection	Point-to-multipoint connection	Internal S0 connection	Settings configured in expert mode
1	1	1	STLS2N	<input checked="" type="radio"/>	<input type="radio"/>	<input type="radio"/>	
1	1	2	STLS2N	<input type="radio"/>	<input type="radio"/>	<input checked="" type="radio"/>	

### Step by Step

- 1) To configure the ISDN trunk connection, clear the check box **No call via ISDN trunk line (S0)**.
- 2) Enable the radio button **Point-to-point connection** for the desired S<sub>0</sub> port.
- 3) Click on **OK & Next**.

## 4.7.4.3 How to Configure the ISDN Point-to-Multipoint Connection

### Prerequisites

- You are in the **ISDN Configuration** window.

Box	Slot	S0-Port	Board Type	Point-to-point connection	Point-to-multipoint connection	Internal S0 connection	Settings configured in expert mode
1	1	1	STLS2N	<input type="radio"/>	<input checked="" type="radio"/>	<input type="radio"/>	
1	1	2	STLS2N	<input type="radio"/>	<input type="radio"/>	<input checked="" type="radio"/>	

### Step by Step

- 1) To configure the ISDN trunk connection, clear the check box **No call via ISDN trunk line (S0)**.
- 2) Enable the radio button **Point-to-multipoint connection** for the desired S<sub>0</sub> port.
- 3) Click on **OK & Next**.

## Initial Setup for OpenScape Business X Basic Configuration

Collect the ISDN MSN for the ISDN point-to-multipoint connection

Enter here all ISDN Multiple Subscriber Numbers (MSN) provided by your network provider.  
During configuration of the stations, you can assign the individual numbers to them.

Box	Slot	S0-Port	ISDN Multiple Subscriber Numbers	
1	1	1	12345678	
1	1	1	2	12345679
1	1	1	3	12344566
1	1	1	4	12344567
1	1	1	5	12344568
1	1	1	6	
1	1	1	7	
1	1	1	8	
1	1	1	9	
1	1	1	10	

- 4) Enter all phone numbers (MSNs) supplied by your provider in the **ISDN multiple subscriber numbers** column. You can enter up to 10 MSNs for each S<sub>0</sub> port. The number of the S<sub>0</sub> connections depends on the communication system and possibly the board being used.
- 5) Click on **OK & Next**.

### 4.7.4.4 How to Deactivate the ISDN Configuration

#### Prerequisites

- You are in the **ISDN Configuration** window.

#### Step by Step

- 1) Select the **No call via ISDN trunk line (S0)** check box.

---

**INFO:** Calls can also be conducted via an Internet Telephony Service Provider; see [Internet Telephony](#).

---

- 2) Click on **OK & Next**.

### 4.7.5 Internet Access

The **Configure Internet Access** window can be used to configure Internet access.

Configure Internet Access

No Internet Access

**Internet Access**

DSL at WAN Port directly

TCP/IP at WAN Port via an external Router

TCP/IP at LAN Port via an external Router



The configuration of Internet access in the WBM depends on whether the Internet connection has already been set up in an external router or whether it occurs via an Internet modem and thus needs to be set up in the WBM.

Only one of the options listed here may be selected.

- Internet access through an Internet modem (**DSL at WAN port directly**)  
You want to operate the communication system directly at an Internet modem (DSL, cable, UMTS ...). OpenScope Business has the Internet router integrated. Enter the access data of the Internet Service Provider (ISP) directly in the communication system and use the WAN port of the communication system.

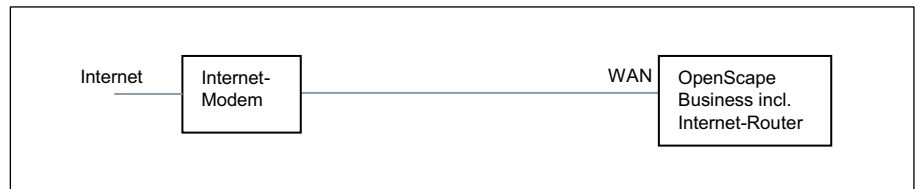

You have the following options:

- Internet access via a preconfigured ISP
- Internet access via the standard ISP PPPoE
- Internet access via the standard ISP PPTP

If your ISP is not listed under the preconfigured ISPs, use the default ISP PPPoE or PPTP.

- Internet access via an external Internet router  
You want to operate the communication system at an external Internet router. The Internet Service Provider is already configured in the Internet router. You have the following options:

- Internet access via an external Internet router at the WAN port (TCP/IP at WAN port via an external router)

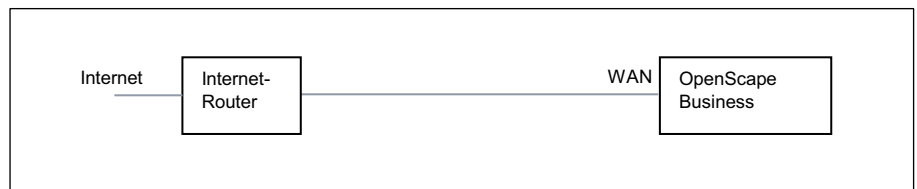

To do this, you use the WAN port of the communication system. OpenScope Business either knows the Internet router or works as a DHCP client. This option can be used if the Internet router is located in another network segment and has its own DHCP server.

- Internet access via an external Internet router at the LAN port (TCP/IP at LAN port via an external router)

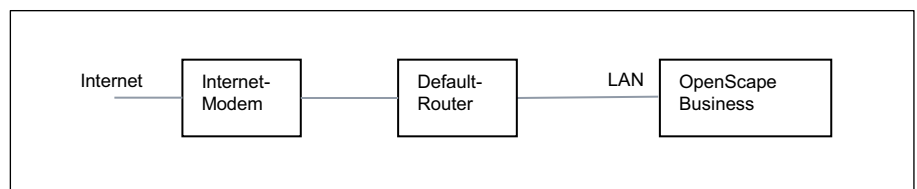

To do this, you use the LAN port of the communication system. OpenScope Business knows only the default router and not the

underlying infrastructure. To activate the connection to the Internet router, the IP address of the default router and that of the DNS server must be made known to the communication system.

- Deactivate Internet access (default setting)  
You do not want to use the Internet.

#### 4.7.5.1 How to Configure Internet Access via an External Internet Router over the LAN Port

##### Prerequisites

- The communication system must be connected to the customer LAN via the "LAN" interface. The connection must not use the WAN port, since the WAN port will be disabled.
- You are in the **Configure Internet Access** window.

##### Step by Step

- 1) Disable the **No Internet Access** check box.
- 2) Activate the radio button **TCP/IP at LAN Port via an external router**, enter the upload speed of your Internet connection in the **Upstream up to (Kbps)** field and click **OK & Next**.

The screenshot shows a window titled "Routing Configuration" with two sections. The first section is labeled "DNS Server" and contains a text field for "IP Address of primary DNS Server" with the value "192.168.1.1". The second section is labeled "Default Router" and contains a text field for "IP Address of Default Router" with the value "192.168.1.1".

- 3) Enter the IP address of the local DNS server (e.g., the Internet router) or the Internet DNS server (for Internet telephony, for example) in the **IP address of the preferred DNS server** field.
- 4) Enter the IP address of the external Internet router in the **IP Address of Default Router** field.
- 5) Click on **OK & Next**.

#### 4.7.5.2 How to Configure Internet Access via an External Internet Router over the WAN Port

##### Prerequisites

- The communication system must be connected to the LAN segment of the customer LAN in which the Internet router is located via the LAN interface "WAN".
- You are in the **Configure Internet Access** window.

### Step by Step

- 1) Disable the **No Internet Access** check box.
- 2) Activate the radio button **TCP/IP at WAN Port via an external router** and click **OK & Next**.

Internet Access

Automatic Address Configuration (via DHCP):

Accept IP Address of the Default Router:

Accept IP Address of the DNS Server:

Accept IP Address of the SNTP Server:

MAC Address : 00:1a:e8:5d:09:92

Ethernet Link Mode: Auto

Max. Data Packet Size (bytes): 1500

Network Address Translation:

Bandwidth Control for Voice Connections: None

Bandwidth for Downloads: 10000

Bandwidth for Uploads: 2000

Bandwidth Used for Voice/Fax (%): 80

IEEE802.1p/q Tagging:

IEEE802.1p/q VLAN ID: 0

- 3) If the network-specific data for the WAN interface are to be obtained from an already active DHCP server:
  - a) Select the check box **Automatic Address Configuration (with DHCP)**.
  - b) Select the **Accept IP Address of the Default Router** check box if you want this IP address to be used.
  - c) Select the check box **Accept IP Address of the DNS Server** if required.
  - d) Select the check box **Accept IP Address of the SNTP Server** if required.
- 4) If a fixed IP address is to be assigned to the WAN interface:
  - a) Clear the check box **Automatic Address Configuration (with DHCP)**.
  - b) Enter the desired **IP address** and **Netmask** of the WAN interface.
- 5) Enable the **NAT** check box.
- 6) If you also want to use Internet Telephony, select the item **Upload only** or **Upload and Download** as needed from the **Bandwidth Control for Voice Connections** drop-down list. If the download bandwidth is high and the upload bandwidth is low, bandwidth control should only be activated for the upload direction to ensure that the download bandwidth reserved for voice transmission is not unnecessarily high.
- 7) In the **Bandwidth for Downloads** and **Bandwidth for Uploads** fields, enter the bandwidth in Kbps for downloads and uploads, respectively, as provided by your Internet Service Provider.
- 8) Click on **OK & Next**.

### 4.7.5.3 How to Configure Internet Access via a Preconfigured ISP

#### Prerequisites

- You are in the **Configure Internet Access** window.
- Your ISP's Internet access data is available (for example, user account, password, bandwidth for upload and download, etc.).
- Optional: The data for a DynDNS account is available to you (name, password, host name, domain name of the DynDNS provider)

#### Step by Step

- 1) Disable the **No Internet Access** check box.
- 2) Activate the radio button **DSL directly at Mainboard WAN Port** and click **OK & Next**.

- 3) Select your ISP from the **Internet Service Provider Selection** drop-down list.
- 4) Enter the access data that you received from your ISP in the **Internet Access Data for...** area. The fields in this area are provider-specific. When entering your data, bear in mind that the input is case-sensitive!
- 5) Depending on your tariff model, select one of the following two options under **Full-Time Circuit** in the **Router Settings** area:
  - If you have a flat rate tariff model, enable the radio button **On**. In the **Forced Disconnect at (hour:min)** field, enter the time at which the Internet connection is to be interrupted (e.g., 01:30). Make sure that no data is exchanged with the Internet (e.g., software downloads or Internet telephony) during this time.
  - If you have a time-based tariff model, enable the radio button **Off**. In the **Disconnect automatically after (seconds)** field, enter the duration of inactivity after which the connection is to be dropped (e.g., 60 seconds).

- 6) Set the following values in the **QoS Parameters** area:
  - a) In the **Bandwidth for Downloads** and **Bandwidth for Uploads** fields, enter the bandwidth in Kbps for downloads and uploads, respectively, as provided by your ISP.
  - b) If you want to use Internet Telephony as well, open the drop-down list **Bandwidth Control for Voice Connections** and select the item **Upload only** or **Upload and Download**, as required. In the field **Bandwidth Used for Voice/Fax (%)**, enter how much bandwidth is to be reserved for voice and fax connections as a percentage value (default value: 80%).
- 7) Click **OK & Next**. You are taken to the **Configure DynDNS-Account** window.
- 8) If you want to use a VPN or remote access and do not have a public static IP address, you will need to have already applied for and set up a DynDNS account (at dyndns.org, for example).
  - a) If your desired DynDNS provider is included in the **Domain name** drop-down list, select it from that list (e.g., dyndns.org).
  - b) If your desired DynDNS provider is not included in the **Domain name** drop-down list, select the **User defined Domain** check box. Enter the desired DynDNS provider in the **Domain name** field and enter the update URL of the DynDNS provider in the **Update URL** field. The structure of this URL depends on the DynDNS provider. In addition, customer-specific parameters (shown in *italics* in the example) must be supplemented.

```
http://www.anydns.info/  
update.php?user=<username>&password=<pass>&host=<domain>&ip=<ipaddr>
```
  - c) Enter the **User name** and the **Password** of your DynDNS account.
  - d) Enter the host name assigned to you by the DynDNS provider, omitting the domain name, for instance, myhost, in the **Hostname** field. Your complete domain name would then be myhost.dyndns.org, for example.
  - e) Test the DynDNS account with **Connection test**.
  - f) After the test succeeds, click **OK**.
  - g) Click **OK & Next**.
- 9) If you have a public static IP address or do not want to use a VPN or remote access, click **No DynDNS**.
- 10) Click **OK & Next**.

#### 4.7.5.4 How to Configure Internet Access via the Standard ISP PPPoE

##### *Prerequisites*

- You are in the **Configure Internet Access** window.
- The following ISP-specific Internet access data is available to you:

**Initial Setup for OpenScape Business X**  
Basic Configuration

Field	Description	Value from ISP
<b>IP Parameters</b> (only for a fixed IP address)		
<b>Remote IP Address of the PPP Connection</b>	IP address of your ISP's server.	
<b>Local IP Address of the PPP Connection</b>	IP address that was assigned to you by your ISP for Internet access.	
<b>Authentication</b> (via PAP or CHAP). PAP is seldom used, since the authentication is unencrypted.		
<b>PPP User Name</b>	User name that was assigned to you by your ISP for the PPP connection.	
<b>PAP Authentication Mode</b>	Authentication mode for the PPP connection over PAP: <b>PAP Client, PAP Host or Not used.</b>	
<b>PAP Password</b>	Password assigned to you by the ISP for PAP authentication	
<b>CHAP Authentication Mode</b>	Authentication mode for PPP connection via CHAP: <b>CHAP Client, CHAP Host, CHAP Client and Host or Not used.</b>	
<b>CHAP Password</b>	Password assigned to you by the ISP for CHAP authentication	
<b>QoS Parameters of Interface</b>		
<b>Bandwidth for Downloads</b>	Value of the full download bandwidth in Kbps provided by the ISP.	
<b>Bandwidth for Uploads</b>	Value of the full upload bandwidth in Kbps provided by the ISP.	

- Optional: The data for a DynDNS account is available to you (name, password, host name, domain name of the DynDNS provider)

**Step by Step**

- 1) Disable the **No Internet Access** check box.
- 2) Activate the radio button **DSL at WAN Port directly** and click **OK & Next**.
- 3) From the **Internet Service Provider Selection** drop-down list, select the standard ISP Type **Provider PPPoE**.
- 4) The **IP parameters** check box in the **IP Parameters** area should only be enabled if the ISP requires an adjustment of these parameters. In this case, enter the values that you have received from your ISP in the **Remote IP Address of the PPP Connection**, **Local IP Address of the PPP Connection** and **Max. Data Packet Size (bytes)** fields. From the **IP Address Negotiation** drop-down list, select the item **Use configured IP address**.
- 5) Depending on your tariff model, select one of the following two options under **Full-Time Circuit** in the **Router Settings** area:
  - If you have a flat rate tariff model, enable the radio button **On**. In the **Forced Disconnect at (hour:min)** field, enter the time at which the Internet connection is to be interrupted (e.g., 01:30). Make sure that no

data is exchanged with the Internet (e.g., software downloads or Internet telephony) during this time.

- If you have a time-based tariff model, enable the radio button **Off**. In the **Disconnect automatically after (seconds)** field, enter the duration of inactivity after which the connection is to be dropped (e.g., 60 seconds).
- 6) The settings in the **Authentication** area depend on whether or not the ISP requires authentication via PPP.
    - Authentication required by ISP: Make sure that the check box **PPP Authentication** is enabled. Enter the Internet access name of the ISP as the PPP user name. The customary standard is the **CHAP Client** authentication mode.
    - Authentication not required by ISP: Make sure that the check box **PPP Authentication** is disabled.
  - 7) If you want to use NAT, enable the **NAT** check box (enabled by default) in the **Address Translation** area.
  - 8) Set the following values in the **QoS Parameters of Interface** area:
    - a) In the **Bandwidth for Downloads** and **Bandwidth for Uploads** fields, enter the bandwidth in Kbps for downloads and uploads, respectively, as provided by your ISP.
    - b) If you want to use Internet Telephony as well, open the drop-down list **Bandwidth Control for Voice Connections** and select the item **Upload only** or **Upload and Download**, as required. In the field **Bandwidth Used for Voice/Fax (%)**, enter how much bandwidth is to be reserved for voice and fax connections as a percentage value (default value: 80%).
  - 9) Click **OK & Next**. You are taken to the **Configure DynDNS-Account** window.
  - 10) If you want to use a VPN or remote access and do not have a public static IP address, you will need to have already applied for and set up a DynDNS account (at [dyndns.org](http://dyndns.org), for example).
    - a) If your desired DynDNS provider is included in the **Domain name** drop-down list, select it from that list (e.g., [dyndns.org](http://dyndns.org)).
    - b) If your desired DynDNS provider is not included in the **Domain name** drop-down list, select the **User defined Domain** check box. Enter the desired DynDNS provider in the **Domain name** field and enter the update URL of the DynDNS provider in the **Update URL** field. The structure of this URL depends on the DynDNS provider. In addition, customer-specific parameters (shown in *italics* in the example) must be supplemented.

```
http://www.anydns.info/  
update.php?user=<username>&password=<pass>&host=<domain>&ip=<ipaddr>
```
    - c) Enter the **User name** and the **Password** of your DynDNS account.
    - d) Enter the host name assigned to you by the DynDNS provider, omitting the domain name, for instance, myhost, in the **Hostname** field. Your complete domain name would then be myhost.dyndns.org, for example.
    - e) Test the DynDNS account with **Connection test**.

- f) After the test succeeds, click **OK**.
- g) Click **OK & Next**.
- 11) If you have a public static IP address or do not want to use a VPN or remote access, click **No DynDNS**.
- 12) Click **OK & Next**.

#### **4.7.5.5 How to Configure Internet Access via a Standard ISP PPTP**

##### ***Prerequisites***

- You are in the **Configure Internet Access** window.
- The following ISP-specific Internet access data is available to you:



Field	Description	Value from ISP
<b>IP Parameters</b> (only for a fixed IP address)		
<b>Remote IP Address of the PPP Connection</b>	IP address of your ISP's server.	
<b>Local IP Address of the PPP Connection</b>	IP address that was assigned to you by your ISP for Internet access.	
<b>PPTP Parameter</b>		
<b>Local IP Address of the Control Connection</b>	IP address that was assigned to you by your ISP for the PPTP connection. The default value is 10.0.0.140.	
<b>Remote IP Address of the Control Connection</b>	IP address of your ISP's server for the PPTP connection. The default value is 10.0.0.138.	
<b>Remote Netmask for the Control Connection</b>	Subnet mask that was assigned to you by your ISP for the PPTP connection. The default value is 255.255.255.248.	
<b>Authentication</b> (via PAP or CHAP). PAP is seldom used, since the authentication is unencrypted.		
<b>PPP User Name</b>	User name that was assigned to you by your ISP for the PPP connection.	
<b>PAP Authentication Mode</b>	Authentication mode for the PPP connection over PAP: <b>PAP Client</b> , <b>PAP Host</b> or <b>Not used</b> .	
<b>PAP Password</b>	Password assigned to you by the ISP for PAP authentication	
<b>CHAP Authentication Mode</b>	Authentication mode for PPP connection via CHAP: <b>CHAP Client</b> , <b>CHAP Host</b> , <b>CHAP Client and Host</b> or <b>Not used</b> .	
<b>CHAP Password</b>	Password assigned to you by the ISP for CHAP authentication	
<b>QoS Parameters of Interface</b>		
<b>Bandwidth for Downloads</b>	Value of the full download bandwidth in Kbps provided by the ISP.	
<b>Bandwidth for Uploads</b>	Value of the full upload bandwidth in Kbps provided by the ISP.	

- Optional: The data for a DynDNS account is available to you (name, password, host name, domain name of the DynDNS provider)

### Step by Step

- 1) Disable the **No Internet Access** check box.
- 2) Activate the radio button **DSL at WAN Port directly** and click **OK & Next**.
- 3) From the **Internet Service Provider Selection** drop-down list, select the standard ISP Type **Provider PPTP**.

- 4) The **IP parameters** check box in the **IP Parameters** area should only be enabled if the ISP requires an adjustment of these parameters. In this case, enter the values that you have received from your ISP in the **Remote IP Address of the PPP Connection**, **Local IP Address of the PPP Connection** and **Max. Data Packet Size (bytes)** fields. From the **IP Address Negotiation** drop-down list, select the item **Use configured IP address**.
- 5) Enter the values that you received from your ISP in the **PPTP Parameter** area.
- 6) If you have a time-based tariff model, select the **Short Hold** check box. In the **Short Hold Time (sec)** field, enter the duration of inactivity after which the connection is to be dropped (e.g., 60 seconds).
- 7) The settings in the **Authentication** area depend on whether or not the ISP requires authentication via PPP.
  - Authentication required by ISP: Make sure that the check box **PPP Authentication** is enabled. Enter the Internet access name of the ISP as the PPP user name. Make the PAP and CHAP settings, as assigned to you by your ISP.
  - Authentication not required by ISP: Make sure that the check box **PPP Authentication** is disabled.
- 8) If you want to use NAT, enable the **NAT** check box (enabled by default) in the **Address Translation** area.
- 9) Set the following values in the **QoS Parameters of Interface** area:
  - a) In the **Bandwidth for Downloads** and **Bandwidth for Uploads** fields, enter the bandwidth in Kbps for downloads and uploads, respectively, as provided by your ISP.
  - b) If you want to use Internet Telephony as well, open the drop-down list **Bandwidth Control for Voice Connections** and select the item **Upload only** or **Upload and Download**, as required. In the field **Bandwidth Used for Voice/Fax (%)**, enter how much bandwidth is to be reserved for voice and fax connections as a percentage value (default value: 80%).
- 10) Click **OK & Next**. You are taken to the **Configure DynDNS-Account** window.
- 11) If you want to use a VPN or remote access and do not have a public static IP address, you will need to have already applied for and set up a DynDNS account (at [dyndns.org](http://dyndns.org), for example).
  - a) If your desired DynDNS provider is included in the **Domain name** drop-down list, select it from that list (e.g., [dyndns.org](http://dyndns.org)).
  - b) If your desired DynDNS provider is not included in the **Domain name** drop-down list, select the **User defined Domain** check box. Enter the desired DynDNS provider in the **Domain name** field and enter the update URL of the DynDNS provider in the **Update URL** field. The structure of this URL depends on the DynDNS provider. In addition, customer-specific parameters (shown in *italics* in the example) must be supplemented.

```
http://www.anydns.info/  
update.php?user=<username>&password=<pass>&host=<domain>&ip=<ipaddr>
```

- c) Enter the **User name** and the **Password** of your DynDNS account.
  - d) Enter the host name assigned to you by the DynDNS provider, omitting the domain name, for instance, myhost, in the **Hostname** field. Your complete domain name would then be myhost.dyndns.org, for example.
  - e) Test the DynDNS account with **Connection test**.
  - f) After the test succeeds, click **OK**.
  - g) Click **OK & Next**.
- 12) If you have a public static IP address or do not want to use a VPN or remote access, click **No DynDNS**.
- 13) Click **OK & Next**.

#### 4.7.5.6 How to Disable Internet Access

##### *Prerequisites*

- You are in the **Configure Internet Access** window.

##### *Step by Step*

- 1) Leave the **No Internet Access** check box enabled.
- 2) Click on **OK & Next**.

#### 4.7.6 Internet Telephony

The **Provider configuration and activation for Internet telephony** window is used to configure Internet telephony. You can configure predefined or new Internet Telephony Service Providers (ITSPs). You can configure one or several accounts for each ITSP. Up to 8 ITSPs may be active simultaneously.

You have the following options:

- **Configure a predefined ITSP**  
You can use predefined ITSP templates. To do this, the own access data and phone numbers are entered in the template, and this is then activated.
- **Configure a new ITSP**  
You can also add and activate a new ITSP. Configuring a new ITSP is seldom required and can be very time-consuming. This option is therefore not described in the initial installation. Detailed information can be found in the chapter [Configuring an ITSP](#).
- **Disable Internet telephony**  
You can disable Internet telephony.

---

**INFO:** Configuration examples can be found on the Internet at the **Unify Experts Wiki** under *OpenScape Business - SIP / ITSP Connectivity - PDF "OSBiz V2 Configuration for ITSP"*.

---

### Assigning the ITSP Phone Numbers

- In the case of an **Internet Telephony Station Connection**, the ITSP provides individual numbers such as 70005555, 70005556, etc. These individual call numbers are then assigned manually as the internal call numbers of the subscribers.
- In the case of an **Internet telephony point-to-point connection**, the ITSP provides a call number range, e.g., (+49) 89 7007-100 to (+49) 89 7007-147. The call numbers from the range are then assigned manually as the internal call numbers of the subscribers.

These two connection types can be combined as appropriate.

Alternatively, the ITSP phone numbers can be entered as the DID call numbers of the subscriber for both connection types during the station configuration.

Internal call number	Name	DID
100	Andreas Richter	897007100
101	Susanne Mueller	897007101
102	Buddy Miller	897007102
104	Juan Martinez	70005555
105	Emilio Carrara	70005556

The ITSP call numbers thus result from the configured PABX number (e.g., country code 49) and the entered DID numbers in long format. This has advantages for the digit analysis and call management, even in an internetwork. The ITSP connection is thus DID-enabled for another node, for example.

A further CO trunk connection via ISDN is only possible to a limited extent in this case (useful for emergency calls, for example).

## 4.7.6.1 How to Configure a Predefined ITSP

### Prerequisites

- You are in the **Provider configuration and activation for Internet Telephony** window.
- The Internet connection is operational.
- Your ITSP's Internet telephony access data is available (for example, user account, password and Internet telephony numbers).

### Step by Step

- 1) Clear the **No call via Internet** check box. A country-specific list of the possible ITSPs is displayed. The list contains the predefined ITSPs for the selected country and any already created ITSPs.

Provider configuration and activation for Internet Telephony

No call via Internet:

Country specific view:

Activate Provider		Internet Telephony Service Provider
<input type="button" value="Add"/>		Other Provider
<input type="button" value="Edit"/>	<input type="checkbox"/>	1&1
<input type="button" value="Edit"/>	<input type="checkbox"/>	Arcor
<input type="button" value="Edit"/>	<input type="checkbox"/>	COLT UK & Europe
<input type="button" value="Edit"/>	<input type="checkbox"/>	COLT VPN
<input type="button" value="Edit"/>	<input type="checkbox"/>	Ennit AG
<input type="button" value="Edit"/>	<input type="checkbox"/>	GMX
<input type="button" value="Edit"/>	<input type="checkbox"/>	Purtel
<input type="button" value="Edit"/>	<input type="checkbox"/>	QSC
<input type="button" value="Edit"/>	<input type="checkbox"/>	Sipgate
<input type="button" value="Edit"/>	<input type="checkbox"/>	Sipgate Trunking
<input type="button" value="Edit"/>	<input type="checkbox"/>	Skype Connect
<input type="button" value="Edit"/>	<input type="checkbox"/>	toplink
<input type="button" value="Edit"/>	<input type="checkbox"/>	Vodafone Anlagenanschluss

- 2) If you want to change the preset country, select the desired country from the **Country specific view** drop-down list to display the ITSPs that are available for this country.
- 3) If required, click **Display Status** to check which ITSPs have already been activated and which Internet telephony subscribers have already been configured under each ITSP. You can activate a maximum of 8 ITSPs. Click **OK** when finished.
- 4) To configure Internet telephony stations, click **Edit** in the line associated with the relevant ITSP.
- 5) Activate the check box **Enable Provider**.
- 6) Click **OK & Next**.
- 7) Click **Add** to configure your ITSP accounts with the corresponding Internet telephony numbers. The fields that will then be displayed are provider-specific.

## Initial Setup for OpenScape Business X Basic Configuration

**Internet Telephony Station for Sipgate**

Internet telephony station:

Authorization name:

Password:

Confirm Password:

**Call number assignment**

Use public number (DID)

Use internal number (Callno) / Single entries

Use internal number (Callno) / Range entry

Default Number:

MEX Number:

**Default Number**  
ITSP as primary CO access  
Enter here one of the call numbers supplied by your network provider. This will be used in outgoing calls as calling party number in case that no other number is available for the respective call.  
All call numbers supplied by your network provider are to be entered within the trunk and telephones configuration (DID field) primary CO access.

**MEX Number**  
To use the feature Mobile Extension (MEX) you have to enter a MEX number here. An entered MEX number will only be stored if the ITSP is marked as 'active'.  
For use of MEX it is also necessary to configure a DISA number.

- 8) Enter the credentials for your account in the **Internet Telephony Station** field. You received this data from your ITSP. Depending on the ITSP, different designations are used for this, for example: SIP User, SIP ID, etc.
- 9) Enter the authorization name in the **Authorization name** field. You received this data from your ITSP. If you have not received any authorization name, enter the same data you entered under **Internet Telephony Station**.
- 10) Enter the password you received from the ITSP in the **New Password** and **Confirm Password** fields. Depending on the ITSP, different designations are used for this, for example: Password, SIP Password, etc.
- 11) Assignment of Internet telephony phone numbers - Option 1:  
**Use public number (DID):** the Internet telephony phone numbers of your Internet telephony station connection or Internet telephony point-to-point connection are not entered here during the ITSP configuration, but when the configuring the stations, i.e. the telephones and subscribers (in the **DID** fields).

Internet Telephony Station for Sipgate

Internet telephony station:

Authorization name:

Password:

Confirm Password:

**Call number assignment**

Use public number (DID)

Use internal number (Callno) / Single entries

Use internal number (Callno) / Range entry

Default Number:

MEX Number:

**Default Number**  
ITSP as primary CO access  
Enter here one of the call numbers supplied by your network provider. This will be used in outgoing calls as calling party number in case that no other number is available for the respective call.  
All call numbers supplied by your network provider are to be entered within the trunk and telephones configuration (DID field) primary CO access.

**MEX Number**  
To use the feature Mobile Extension (MEX) you have to enter a MEX number here. An entered MEX number will only be stored if the ITSP is marked as 'active'.  
For use of MEX it is also necessary to configure a DISA number.

- a) Select the option field **Use public number (DID)** in the **Call number assignment** area.
- b) Under **Default Number**, enter the phone number to be used for outgoing calls to subscribers who do not have their own phone number.
- c) If your ITSP supports the "Mobile Extension (MEX)" feature, enter the MEX number provided by the ITSP (8 positions, digits only) under **MEX Number**.

**12) Assignment of Internet telephony phone numbers - Option 2:**

**Use internal number (Callno) / Single entries:** You have an Internet telephony station connection and have received individual call numbers as Internet telephony phone numbers (e.g. 70005555, 70005556,...). Then assign these single numbers to the internal call numbers of the subscribers.

Internet Telephony Station for Sipgate

Internet telephony station:

Authorization name:

Password:

Confirm Password:

**Call number assignment**

Use public number (DID)

Use internal number (Callno) / Single entries

Use internal number (Callno) / Range entry

Internet Telephony Phone Numbers

Add

Enter here all call numbers supplied by your network provider.  
Assignment of call numbers to telephones takes place in a further configuration step.

- a) Select the option field **Use internal number (Callno) / Single entries** in the **Call number assignment** area.

- b) In the **Internet Telephony Phone Numbers** area, enter one of the Internet telephony phone numbers provided by the ITSP in the field next to the **Add** button and then click **Add**.
- c) To assign further Internet telephony numbers to the account, repeat step b).

**13) Assignment of Internet telephony phone numbers - Option 3:**

**Use internal number (Callno) / Range entry:** You have an Internet telephony point-to-point connection and have received a call number range as Internet telephony phone numbers (e.g., +49 89 7007-100 to (+49) 89 7007-147. You then assign the call numbers from the call number range as the internal call numbers of the subscribers.

Internet Telephony Station for Sipgate

Internet telephony station: 33455655  
Authorization name: 33455655  
Password: .....  
Confirm Password: .....

**Call number assignment**

Use public number (DID)   
Use internal number (Callno) / Single entries   
Use internal number (Callno) / Range entry

**Internet telephony system phone number**

System phone number (Prefix): 49 89 7007  
Call numbers from 100 up to 147

Here you may enter the call numbers supplied by your network provider by defining a range of numbers and a prefix, which is common to all numbers.  
Assignment of call numbers to telephones takes place in a further configuration step.

- a) Select the option field **Use internal number (Callno) / Range entry** in the **Call number assignment** area.
- b) Enter the system phone number under **System phone number (prefix)**.
- c) Enter the desired DID number range for the Internet telephony station in the 'from' and 'to' fields after Direct inward dialing band. The range entered by default is 100 - 147.

**14) Click on OK & Next.**

**15) If you want to configure additional accounts and their associated Internet telephony numbers, repeat steps 7 through 14.**

**16) Click OK & Next.** You will see an overview of which Internet telephony phone numbers are assigned to accounts.

**17) Assign one internal station number each to every Internet telephony phone number.**

This step is not required if you have selected option 1 for the assignment of the Internet telephony phone numbers. In this case, the assignment is made when the configuring the stations (i.e., the telephones and subscribers) in the **DID** field.



Call Number Assignment for Sipgate			
So that an internal participant or members of a call group can telephone via Internet without an "Internet Telephony Phone Number", the "Internet Telephony Phone Number" must be configured with Use as PABX number for outgoing calls.			
Name of Internet Telephony Station	Internet Telephony Phone Number	Internal Call Number	Use as PABX number for outgoing calls
3455655	49897007100	100 Andreas Richter	<input checked="" type="radio"/>
3455655	49897007101	101 Susanne Mueller	<input type="radio"/>
3455655	49897007102	102 Buddy Miller	<input type="radio"/>
3455655	49897007103	103 Janet Jones	<input type="radio"/>
3455655	49897007110	110 Natalie Dubois	<input type="radio"/>
3455655	49897007111	111 Pierre Martin	<input type="radio"/>
3455655	49897007112	112 Claudia Ferraro	<input type="radio"/>
3455655	49897007113	113 Giovanni Rossi	<input type="radio"/>
3455655	49897007114	114 Carlos Alvarez	<input type="radio"/>
3455655	49897007115	115 Emilia Gonzales	<input type="radio"/>
3455655	49897007120	120 Isabel Ferreira	<input type="radio"/>
3455655	49897007121	121 Paolo DaSilva	<input type="radio"/>
3455655	49897007122	122 Ivan VanDenBerg	<input type="radio"/>
3455655	49897007123	123 Robert DeJong	<input type="radio"/>

- a) To do this, select an internal call number in the appropriate line from the **Internal Call Number** drop-down list.
  - b) If subscribers without Internet telephony phone numbers or members of a call group are to be allowed to make external calls via the Internet, the radio button **Use as PABX number for outgoing calls** must be activated. The radio button can be activated for only one single Internet telephony phone number.
- 18) Click **OK & Next**. Here you see again the list of predefined and newly added ITSPs. The enabled ITSPs are identified with a check mark in the **Enable Provider** column. If you are having connection problems with already activated ITSP, you can register it again with **Restart ITSP**.
- 19) Click **OK & Next**.
- 20) Enter the upload speed of your Internet connection in the **Upstream up to (Kbps)** field. Please do not confuse this with the download speed!

---

**INFO:** The number of simultaneous Internet calls permitted is displayed in the **Number of Simultaneous Internet calls** field. If the voice quality deteriorates due to the network load, you will need to reduce the number.

---

- 21) Click **OK & Next**.
- 22) If you did not activate the full-time circuit when setting up your Internet access, you can now do this here. Without a permanent connection (full-time circuit), you cannot receive calls over the Internet. If the full-time circuit has already been set up, the fields described under a) to c) will not appear.
- a) Enable the radio button **On** under **Full-Time Circuit**.
  - b) In the **Forced Disconnect at (hour:min)** field, enter the time at which the Internet connection is to be deactivated (e.g., 04:59).
  - c) Click **OK & Next**.
- 23) Enter the special numbers you want in the **Dialed digits** column.

## Initial Setup for OpenScape Business X Basic Configuration

Special phone numbers		
Special phone number	Dialed digits	Dial over Provider
1	0C112	ISDN
2	0C110	ISDN
3	0C0137Z	ISDN
4	0C0138Z	ISDN
5	0C0900Z	ISDN
6	0C118Z	ISDN
7	0C116116	ISDN
8		ISDN
9		ISDN
10		ISDN
11		ISDN
12		ISDN
13		ISDN
14		ISDN
15		ISDN

The following station number entries are valid:

0 to 9: allowed digits

-: Field separator

X: Any digit from 0 to 9

N: Any digit from 2 to 9

Z: One or more digits to follow up to the end of dialing

C: Simulated dial tone (can be entered up to three times)













**24)** Use the **Dial over Provider** column to specify whether the special number should be dialed via ISDN or an ITSP. Only the active ITSP is displayed.

---

**INFO:** Ensure that emergency numbers can always be dialed. If you want to dial emergency numbers via an Internet Telephony Service Provider, you must make sure that the ITSP supports this feature.

---

**25)** Click **OK & Next**. The status of your ITSP will be displayed.

Status for the Internet Telephony Service Provider (ITSP)			
Provider		User	
	1&1	Disabled	
	Arcor	Disabled	
	COLT UK & Europe	Disabled	
	COLT VPN	Disabled	
	Ennit AG	Disabled	
	GMX	Disabled	
	Purteil	Disabled	
	QSC	Disabled	
	Sipgate	Enabled	33455655 registered
	Sipgate Trunking	Disabled	
	Skype Connect	Disabled	
	toplink	Disabled	
	Vodafone Anlagenanschluss	Disabled	

The configured ITSPs at which you are already registered are marked in green.

The configured ITSPs at which you are not yet registered are marked in orange.

26) Click **Next** followed by **Finish**.

## 4.7.6.2 How to Deactivate Internet Telephony

### Prerequisites

- You are in the **Provider configuration and activation for Internet Telephony** window.

### Step by Step

- 1) Leave the **No call via Internet** check box selected.
- 2) Click **OK & Next** twice.

## 4.7.7 Stations

In the **Select a station - ...** window, you can configure the stations connected to the communication system.

Proceed as follows:

1. Configure ISDN stations  
ISDN stations include ISDN phones or ISDN fax devices, for example. ISDN stations can only be configured if an S<sub>0</sub> interface has been set up as the internal S<sub>0</sub> port.
2. Configure analog stations  
Analog stations include analog phones or analog fax devices, for example.
3. Configure UP0 stations  
UP0 stations include system phones such as OpenStage 60 T.

4. Configure DECT stations  
DECT stations are Cordless/DECT phones. DECT stations can only be configured if one or more Cordless base stations are connected and if the DECT phones have been registered at the base stations. Manager E is used to perform the configuration. For more detailed information on the Cordless configuration, see [Configuring the Integrated Cordless Solution](#)
5. Configure the IP and SIP stations  
IP and SIP stations include LAN phones or WLAN phones, for example.

### 4.7.7.1 How to Configure ISDN Stations

#### Prerequisites

- You are in the **Select a station - ISDN Devices** window.
- The S<sub>0</sub> ports to which the ISDN phones are to be connected must be configured as internal S<sub>0</sub>ports.

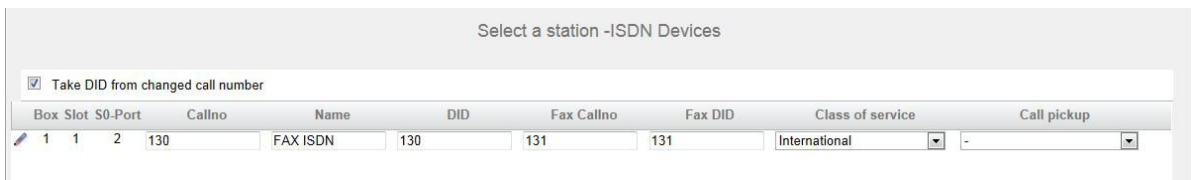

#### Step by Step

- 1) If you want a different direct inward dialing number for the station than the call number, enter a DID number for the station under **DID** in the row of the desired station:
  - Only for a point-to-point connection:  
Click in the desired field and type in the DID number using the keyboard. The DID number may also be identical to the internal station number.
  - Only for a point-to-multipoint connection:  
Select an MSN in the desired field via the drop-down list. The station can be internally reached via the internal station number 101, for example, and externally via the MSN 654321.
  - For point-to-point and point-to-multipoint connections:  
Select the entry **xxx - modifiable** (xxx is the internal station number) via the drop-down list in the desired field and type in the DID number using the keyboard or select an MSN from the drop-down list.
- 2) Enter the internal station number for the subscriber under **Call No** in the appropriate row of the desired subscriber. You can use the preset phone number or assign some other free number.
- 3) In the row of the desired station, under **Name**, enter a name in the format Last Name, First Name OR First Name Last Name.

---

**INFO:** The name can consist of up to 16 characters, but must not include any diacritical characters such as umlauts or special characters.

---

- 4) If you want to set up a fax box for the subscriber (which can be used with the UC clients **myPortal for Desktop** or **myPortal for Outlook**, for example), proceed as follows:
  - a) In the row of the desired station, in the **Fax No.** field, enter the desired internal fax number at which the user can receive internal fax messages.
  - b) If you want to configure a DID number for the fax box, enter the desired external fax number under which the subscriber can receive external fax messages in the **Fax Direct Inward Dialing** field in the row of the desired subscriber.
- 5) Choose the desired Class of Service group in the row of the desired subscriber from the **Class of Service** drop-down list.
- 6) To add the subscriber to a call pickup group, select a call pickup group from the **Call pickup group** drop-down list in the row of the desired subscriber.
- 7) Make the settings described under this step only if needed:
  - a) Click in the row of the desired ISDN station on the pencil icon **Edit**.

Change Station

**Station**

Name: FAX ISDN  
(for Subscriber):

Call number: 130

Direct inward dialing: 130  
(Number for Direct Inward Dialing)

**direct inward dialing for Internet Telephony**

Sipgate: 4989565656114

Application Suite:

**Parameter**

Device Type: S0 Extension

Clip/Lin: -

Access: STLS2N 1-2-1

Extension Type: Fax

Language: German

Call signaling internal: Ring type 1  
(Ringer pitch for internal calls):

Call signaling external: Ring type 1  
(Ringer pitch for external calls):

- b) In the **Clip/Lin** field, enter a phone number (DID number or MSN) to be displayed at the called party's extension instead of the own phone number in the case of an external call.

---

**INFO:** This feature must be released by the network provider.

---

- c) Select the type of ISDN terminal from the **Extension Type** drop-down list.
      - d) Select a DID number from the drop-down list in the **Direct inward dialing for Internet Telephony** area. A drop-down list is displayed for every active ITSP.

---

**INFO:** The **DID for Internet Telephony** field is not visible if Internet telephony is not configured or if no Internet Telephony Service Provider has been activated.

---

- e) From the **Call signaling internal** drop-down list, select and assign one of a total of eight possible acoustic call signals for internal calls. The station then will then send the modified ringing tone to other internal stations, thus enabling its calls to be distinguished from other internal stations (default: Ring type 1).
  - f) From the **Call signaling external** drop-down list, select and assign one of a total of three possible acoustic call signals for external calls (default: Ring type 1).
  - g) Click on **OK & Next**.
  - h) Change the station flags as needed. For a description of the station flags, see [Station > Station > Station Parameters](#).
  - i) Click on **OK & Next**.
- 8) If you want to configure additional ISDN stations, click on **Store data** and repeat steps 1 through 7.
- 9) Click on **OK & Next**.

### 4.7.7.2 How to Configure Analog Stations

#### Prerequisites

- You are in the **Select a station - A/B Phones** window.
- A mainboard or a board with analog interfaces is available.

Box	Slot	a/b-Port	Callno	Name	DID	Fax Callno	Fax DID	Class of service	Call pickup
1	3	1	140	Polyspan Analog	140	-	-	International	-
1	3	2	141	FAX Analog	141	142	142	International	-
1	3	3	-	-	-	-	-	International	-
1	3	4	-	-	-	-	-	International	-

#### Step by Step

- 1) If you want a different direct inward dialing number for the station than the call number, enter a DID number for the station under **DID** in the row of the desired station:
  - Only for a point-to-point connection:  
Click in the desired field and type in the DID number using the keyboard. The DID number may also be identical to the internal station number.

- Only for a point-to-multipoint connection:  
Select an MSN in the desired field via the drop-down list. The station can be internally reached via the internal station number 101, for example, and externally via the MSN 654321.
  - For point-to-point and point-to-multipoint connections:  
Select the entry **xxx - modifiable** (xxx is the internal station number) via the drop-down list in the desired field and type in the DID number using the keyboard or select an MSN from the drop-down list.
- 2) Enter the internal station number for the subscriber under **Call No** in the appropriate row of the desired subscriber. You can use the preset phone number or assign some other free number.
  - 3) In the row of the desired station, under **Name**, enter a name in the format `Last Name, First Name` or `First Name Last Name`.

---

**INFO:** The name can consist of up to 16 characters, but must not include any diacritical characters such as umlauts or special characters.

---

- 4) If you want to set up a fax box for the subscriber (which can be used with the UC clients **myPortal for Desktop** or **myPortal for Outlook**, for example), proceed as follows:
  - a) In the row of the desired station, in the **Fax No.** field, enter the desired internal fax number at which the user can receive internal fax messages.
  - b) If you want to configure a DID number for the fax box, enter the desired external fax number under which the subscriber can receive external fax messages in the **Fax DID** field in the row of the desired subscriber.
- 5) Choose the desired Class of Service group in the row of the desired subscriber from the **Class of Service** drop-down list.
- 6) To add the subscriber to a call pickup group, select a call pickup group from the **Call pickup group** drop-down list in the row of the desired subscriber.
- 7) Make the settings described under this step only if needed:
  - a) Click in the row of the desired analog station on the pencil icon **Edit**.

## Initial Setup for OpenScape Business X Basic Configuration

Change Station

**Station**

Name: FAX Analog  
(for Subscriber):

Call number: 141

Direct inward dialing: 141  
(Number for Direct Inward Dialing)

**direct inward dialing for Internet Telephony**

Sipgate: 4989565656115

Application Suite:

**Parameter**

Device Type: analog

Clip/Lin: -

Access: 4SLAV 3-2

Extension Type: Fax

Language: German

Call signaling internal:  
(Ringer pitch for internal calls): Ring type 1

Call signaling external:  
(Ringer pitch for external calls): Ring type 1

- b)** In the **Clip/Lin** field, enter a phone number (DID number or MSN) to be displayed at the called party's extension instead of the own phone number in the case of an external call.

---

**INFO:** This feature must be released by the network provider.

---

- c)** Select the analog terminal type (Fax, for instance) from the **Extension Type** drop-down list.
- d)** Select a DID number from the drop-down list in the **Direct inward dialing for Internet Telephony** area. A drop-down list is displayed for every active ITSP.

---

**INFO:** The **DID for Internet Telephony** field is not visible if Internet telephony is not configured or if no Internet Telephony Service Provider has been activated.

---

- e)** From the **Call signaling internal** drop-down list, select and assign one of a total of eight possible acoustic call signals for internal calls. The station then will then send the modified ringing tone to other internal stations, thus enabling its calls to be distinguished from other internal stations (default: Ring type 1).
- f)** From the **Call signaling external** drop-down list, select and assign one of a total of three possible acoustic call signals for external calls (default: Ring type 1).
- g)** Click on **OK & Next**.
- h)** Change the station flags as needed. For a description of the station flags, see [Station > Station > Station Parameters](#).
- i)** Click on **OK & Next**.
- 8)** If you want to configure another analog station, click on **Store data** and repeat steps 1 through 7.



9) Click on **OK & Next**.

### 4.7.7.3 How to Configure UP0 Stations

#### Prerequisites

- You are in the **Select a station - UP0 Stations** window.
- A mainboard or a board with UP0 interfaces is available.

Select a station -UP0 Phones

Take DID from changed call number

Box	Slot	UP0-Port	Callno	Name	DID	Fax Callno	Fax DID	Class of service	Call pickup
1	2	1 M	100	Andreas Richter	100	-	-	International	-
1	2	2 M	101	Susanne Mueller	101	-	-	International	-
1	2	3 M	102	Buddy Miller	102	-	-	International	-
1	2	4 M	103	Janet Jones	103	-	-	International	-
1	2	5 M	-	-	-	-	-	International	-
1	2	6 M	-	-	-	-	-	International	-
1	2	7 M	-	-	-	-	-	International	-
1	2	8 M	-	-	-	-	-	International	-
1	2	1 S	-	-	-	-	-	International	-
1	2	2 S	-	-	-	-	-	International	-

#### Step by Step

- 1) If you want a different direct inward dialing number for the station than the call number, enter a DID number for the station under **DID** in the row of the desired station:
  - Only for a point-to-point connection:  
Click in the desired field and type in the DID number using the keyboard. The DID number may also be identical to the internal station number.
  - Only for a point-to-multipoint connection:  
Select an MSN in the desired field via the drop-down list. The station can be internally reached via the internal station number 101, for example, and externally via the MSN 654321.
  - For point-to-point and point-to-multipoint connections:  
Select the entry **xxx - modifiable** (xxx is the internal station number) via the drop-down list in the desired field and type in the DID number using the keyboard or select an MSN from the drop-down list.
- 2) Enter the internal station number for the subscriber under **Call No** in the appropriate row of the desired subscriber. You can use the preset phone number or assign some other free number.
- 3) In the row of the desired station, under **Name**, enter a name in the format Last Name, First Name OR First Name Last Name.

---

**INFO:** The name can consist of up to 16 characters, but must not include any diacritical characters such as umlauts or special characters.

---

- 4) If you want to set up a fax box for the subscriber (which can be used with the UC clients **myPortal for Desktop** or **myPortal for Outlook**, for example), proceed as follows:
  - a) In the row of the desired station, in the **Fax No.** field, enter the desired internal fax number at which the user can receive internal fax messages.
  - b) If you want to configure a DID number for the fax box, enter the desired external fax number under which the subscriber can receive external fax messages in the **Fax Direct Inward Dialing** field in the row of the desired subscriber.
- 5) Choose the desired Class of Service group in the row of the desired subscriber from the **Class of Service** drop-down list.
- 6) To add the subscriber to a call pickup group, select a call pickup group from the **Call pickup group** drop-down list in the row of the desired subscriber.
- 7) Make the settings described under this step only if needed:
  - a) Click in the row of the desired station on the pencil icon **Edit**.

Change Station

**Station**

Name:   
(for Subscriber):

Call number:

Direct inward dialing:   
(Number for Direct Inward Dialing)

**direct inward dialing for Internet Telephony**

Sippate:

Application Suite:

**Parameter**

Device Type:

Clip/Lin:

Language:

Call signaling internal:   
(Ringer pitch for internal calls):

Call signaling external:   
(Ringer pitch for external calls):

- b) In the **Clip/Lin** field, enter a phone number (DID number or MSN) to be displayed at the called party's extension instead of the own phone number in the case of an external call.

---

**INFO:** This feature must be released by the network provider.

---

- c) Select the type of TDM terminal from the **Extension Type** drop-down list.
  - d) Do not change the default selection in the **Language** drop-down list. This setting has no relevance for TDM terminals.
  - e) Select a DID number from the drop-down list in the **Direct inward dialing for Internet Telephony** area. A drop-down list is displayed for every active ITSP.

---

**INFO:** The **DID for Internet Telephony** field is not visible if Internet telephony is not configured or if no Internet Telephony Service Provider has been activated.

---

- f) From the **Call signaling internal** drop-down list, select and assign one of a total of eight possible acoustic call signals for internal calls. The station then will then send the modified ringing tone to other internal stations, thus enabling its calls to be distinguished from other internal stations (default: Ring type 1).
  - g) From the **Call signaling external** drop-down list, select and assign one of a total of three possible acoustic call signals for external calls (default: Ring type 1).
  - h) Click on **OK & Next**.
  - i) Change the station flags as needed. For a description of the station flags, see [Station > Station > Station Parameters](#).
  - j) Click on **OK & Next**.
- 8) If you want to configure another UP0 station, click on **Store data** and repeat steps 1 through 7.
- 9) Click on **OK & Next**.

#### 4.7.7.4 How to Configure DECT Stations

##### Prerequisites

- You are in the **Select a station - DECT Stations** window.
- To configure DECT stations, a base station must be connected, and the DECT phones must be logged in there. If this is not the case, skip this window. You can also configure the DECT stations later (see [Configuring Stations](#)).

Select a station -DECT Phones

Take DID from changed call number

	Box	Slot	Dect-Port	Callno	Name	DID	Fax Callno	Fax DID	Class of service
	1	2	1	2120	DECT 2120	2120	-	-	International
	1	2	2	2121	DECT 2121	2121	-	-	International
	1	2	3	2122	DECT 2122	2122	-	-	International
	1	2	4	2123	DECT 2123	2123	-	-	International
	1	2	5	2124	DECT 2124	2124	-	-	International

### Step by Step

- 1) If you want a different direct inward dialing number for the station than the call number, enter a DID number for the station under **DID** in the row of the desired station:
  - Only for a point-to-point connection:  
Click in the desired field and type in the DID number using the keyboard. The DID number may also be identical to the internal station number.
  - Only for a point-to-multipoint connection:  
Select an MSN in the desired field via the drop-down list. The station can be internally reached via the internal station number 101, for example, and externally via the MSN 654321.
  - For point-to-point and point-to-multipoint connections:  
Select the entry **xxx - modifiable** (xxx is the internal station number) via the drop-down list in the desired field and type in the DID number using the keyboard or select an MSN from the drop-down list.
- 2) Enter the internal station number for the subscriber under **Call No** in the appropriate row of the desired subscriber. You can use the preset phone number or assign some other free number.
- 3) If you want to set up a fax box for the subscriber (which can be used with the UC clients **myPortal for Desktop** or **myPortal for Outlook**, for example), proceed as follows:
  - a) In the row of the desired station, in the **Fax No.** field, enter the desired internal fax number at which the user can receive internal fax messages.
  - b) If you want to configure a DID number for the fax box, enter the desired external fax number under which the subscriber can receive external fax messages in the **Fax Direct Inward Dialing** field in the row of the desired subscriber.
- 4) In the row of the desired station, under **Name**, enter a name in the format `Last Name, First Name Or First Name Last Name`.

---

**INFO:** The name can consist of up to 16 characters, but must not include any diacritical characters such as umlauts or special characters.

---
- 5) Choose the desired Class of Service group in the row of the desired subscriber from the **Class of Service** drop-down list.
- 6) To add the subscriber to a call pickup group, select a call pickup group from the **Call pickup group** drop-down list in the row of the desired subscriber.
- 7) If you want to change the DECT phone code (PIN), enter the new code in the row of the desired subscriber under **Mobile code**. The DECT subscribers must log on at the base station again with this code.
- 8) Make the settings described under this step only if needed:
  - a) Click in the row of the desired station on the pencil icon **Edit**.

Change Station

Station	Station	Fax
Name: (for Subscriber): DECT 2120		
Call number: 2120		
Direct inward dialing: (Number for Direct Inward Dialing) 2120		
<b>direct inward dialing for Internet Telephony</b>		
toplink: [ ] [ ]		
<b>Parameter</b>		
Device Type: Comfort PP		
Clip/Lin: [ ]		
Language: German [ ]		
Call signaling internal: (Ringer pitch for internal calls): Ring type 1 [ ]		
Call signaling external: (Ringer pitch for external calls): Ring type 1 [ ]		

- b)** In the **Clip/Lin** field, enter a phone number (DID number or MSN) to be displayed at the called party's extension instead of the own phone number in the case of an external call.

---

**INFO:** This feature must be released by the network provider.

---

- c)** Select the type of cordless device from the **Extension Type** drop-down list.
- d)** Do not change the default selection in the **Language** drop-down list. This setting has no relevance for cordless devices.
- e)** Select a DID number from the drop-down list in the **Direct inward dialing for Internet Telephony** area. A drop-down list is displayed for every active ITSP.

---

**INFO:** The **DID for Internet Telephony** field is not visible if Internet telephony is not configured or if no Internet Telephony Service Provider has been activated.

---

- f)** From the **Call signaling internal** drop-down list, select and assign one of a total of eight possible acoustic call signals for internal calls. The station then will then send the modified ringing tone to other internal stations, thus enabling its calls to be distinguished from other internal stations (default: Ring type 1).
- g)** From the **Call signaling external** drop-down list, select and assign one of a total of three possible acoustic call signals for external calls (default: Ring type 1).
- h)** Click on **OK & Next**.
- i)** Change the station flags as needed. For a description of the station flags, see [Station > Station > Station Parameters](#).
- j)** Click on **OK & Next**.
- 9)** If you want to configure another station, click on **Store Data** and repeat steps 1 through 8.

10) Click on **OK & Next**.

### 4.7.7.5 How to Configure IP and SIP Stations

#### Prerequisites

- You are in the **Select a station - LAN Phones** window.
- A functional wireless LAN network is needed to operate WLAN phones.

Box Slot	Callno	Name	DID	Type	Fax Callno	Fax DID	Class of service	Call pickup
1 0	110	Natalie Dubois	110	System Client	-	-	International	-
1 0	111	Pierre Martin	111	System Client	-	-	International	-
1 0	112	Claudia Ferraro	112	System Client	-	-	International	-
1 0	113	Giovanni Rossi	113	System Client	-	-	International	-
1 0	114	Carlos Alvarez	114	System Client	-	-	International	-
1 0	115	Emilia Gonzales	115	System Client	-	-	International	-
1 0	120	Isabel Ferreira	120	SIP Client	-	-	International	-
1 0	121	Paolo DaSilva	121	SIP Client	-	-	International	-
1 0	122	Ivan VanDenBerg	122	SIP Client	-	-	International	-
1 0	123	Robert DeJong	123	SIP Client	-	-	International	-

#### Step by Step

- 1) If you want a different direct inward dialing number for the station than the call number, enter a DID number for the station under **DID** in the row of the desired station:
  - Only for a point-to-point connection:  
Click in the desired field and type in the DID number using the keyboard. The DID number may also be identical to the internal station number.
  - Only for a point-to-multipoint connection:  
Select an MSN in the desired field via the drop-down list. The station can be internally reached via the internal station number 101, for example, and externally via the MSN 654321.
  - For point-to-point and point-to-multipoint connections:  
Select the entry **xxx - modifiable** (xxx is the internal station number) via the drop-down list in the desired field and type in the DID number using the keyboard or select an MSN from the drop-down list.
- 2) Enter the internal station number for the subscriber under **Call No** in the appropriate row of the desired subscriber. You can use the preset phone number or assign some other free number.
- 3) In the row of the desired station, under **Name**, enter a name in the format Last Name, First Name.

**INFO:** The name can consist of up to 16 characters, but should not include any diacritical characters such as umlauts or special

characters. The name specified here will be entered as the Last Name at the UC clients, but can be edited there.

- 4) Select the type of IP station (e.g., "System Client" or "SIP Client") from the **Type** drop-down list in the row of the desired station.
- 5) If you want to set up a fax box for the subscriber (which can be used with the UC clients **myPortal for Desktop** or **myPortal for Outlook**, for example), proceed as follows:
  - a) In the row of the desired station, in the **Fax No.** field, enter the desired internal fax number at which the user can receive internal fax messages.
  - b) If you want to configure a DID number for the fax box, enter the desired external fax number under which the subscriber can receive external fax messages in the **Fax Direct Inward Dialing** field in the row of the desired subscriber.
- 6) Choose the desired Class of Service group in the row of the desired subscriber from the **Class of Service** drop-down list.
- 7) To add the subscriber to a call pickup group, select a call pickup group from the **Call pickup group** drop-down list in the row of the desired subscriber.
- 8) Make the settings described under this step only if needed or for a SIP phone:
  - a) Click in the row of the desired station on the pencil icon **Edit**.

Change Station	
Station	Fax
Name: (for Subscriber): Paolo DaSilva	
Call number: 121	-
Direct inward dialing: (Number for Direct Inward Dialing) 121	-
<b>Mobility</b>	
Mobile Call number: 0016012345678	
Web Feature ID: (SIP Client) 121	
<b>direct inward dialing for Internet Telephony</b>	
Sipgate: 4989565656111	
<b>Parameter</b>	
Type: SIP Client	
Device Type: SIP Extension	
Clip/Lin: -	
Language: German	
Call signaling internal: (Ringer pitch for internal calls): Ring type 1	
Call signaling external: (Ringer pitch for external calls): Ring type 1	
<b>Security</b>	
Authentication active: <input checked="" type="checkbox"/>	
Password: .....	
Confirm password: .....	
SIP User ID / Username: SIP-121	
Realm: SOBIZ-SIP	

- b) For SIP phones: If the SIP phone is to be operated in conjunction with a dual-mode mobile phone, enter the dialout prefix followed by the telephone number of the mobile phone (e.g., 0016012345678) in the Mobility area under Mobile phone number. In addition, select this SIP

client from the Web Feature ID drop-down list. (see [Dual-Mode Telephony](#)).

- c) In the **Clip/Lin** field, enter a phone number (DID number or MSN) to be displayed at the called party's extension instead of the own phone number in the case of an external call.

---

**INFO:** This feature must be released by the network provider.

---

- d) Select the language for the menu controls on the phone from the **Language** drop-down list.
  - e) From the **Call signaling internal** drop-down list, select and assign one of a total of eight possible acoustic call signals for internal calls. The station then will then send the modified ringing tone to other internal stations, thus enabling its calls to be distinguished from other internal stations (default: Ring type 1).
  - f) From the **Call signaling external** drop-down list, select and assign one of a total of three possible acoustic call signals for external calls (default: Ring type 1).
  - g) Only for SIP phones: Enable the **Authentication active** check box.
  - h) Only for SIP phones: Enter the authentication password in the **Password** and **Confirm password** fields.
  - i) Only for SIP phones: Enter the user ID for the authentication in the **SIP User ID / Username** field.
  - j) Only for SIP phones: Enter the associated zone for the authentication in the **Realm** field.
  - k) Click on **OK & Next**.
  - l) Change the station flags as needed. For a description of the station flags, see [Station > Station > Station Parameters](#).
  - m) Click on **OK & Next**.
- 9) If you want to configure another IP station, click on **Store data** and repeat steps 1 through 8.
  - 10) Click on **OK & Next**. A list of all configured stations appears. This list is effectively a dial plan.
  - 11) If required, click **Print** to print out the data of the configured stations.
  - 12) Then click **OK & Next**.

## 4.7.8 Configuring UC Suite

You can perform the automatic configuration of the UC solution UC Suite in the **Automatic Configuration of the Application Suite** window.



---

**INFO:** This window appears only if **Package with UC Suite** was selected during the application selection in the **Initial Installation** wizard.

---

### 4.7.8.1 How to Configure the UC Suite

#### Prerequisites

- You are in the **Automatic Configuration of Application Suite** window.

Automatic Configuration of Application Suite

Sip Interconnection 1: -  
Sip Interconnection 2: -

Application Suite is not configured.

Please press 'Ok & Next' for skipping this page or press 'Execute function' to proceed with the automatic Application Suite configuration.

Note that by pressing 'Execute function' Sip Interconnection 1 will be overwritten and assigned to Application Suite profile.

Clear SIP Interconnection 1:  
Add 46 trunks to SIP Interconnection 1:  
Application Suite Configuration:  
Smart VM deactivation:

#### Step by Step

- 1) If no UC Booster Card is integrated into the communication system, click on **OK & Next**. The configuration will be skipped.
- 2) If the UC Booster Card is integrated into the communication system, click on **Execute function**. The UC Suite is configured automatically. Once the progress bar shows 100%, click on **OK & Next**.

### 4.7.9 Configuring UC Smart Mailboxes

If you are using the UC solution UC Smart, you can perform the automatic configuration of the UC Smart voicemail boxes (Smart VM, Smart VoiceMail) in the **Automatic Configuration of Smart VM** window.

---

**INFO:** This window appears only if **Package with UC Smart** was selected during the application selection in the **Initial Installation** wizard.

---

#### 4.7.9.1 How to Configure UC Smart Voicemail Boxes

#### Prerequisites

- You are in the **Automatic Configuration of Smart VM** window.

## Initial Setup for OpenScape Business X Basic Configuration

Automatic Configuration of Smart VM

- The automatic Smart VM configuration is an initial configuration. There will be voicemailboxes assigned to the first 100 stations in system. If there are already existing voicemail or autoattendant mailboxes, then all mailbox data will be deleted irrevocably!
- Press "Ok & Next" for skipping this page or press "Execute function" to proceed with Smart VM configuration.

Total Progress

Functionality

### Step by Step

- 1) If the UC Smart voicemail boxes are not to be used, click on **OK & Next**. The configuration of the voicemail boxes will be skipped.
- 2) If the UC Smart voicemail boxes are to be used, click on **Execute function**. Voicemail boxes are then automatically configured for the first 100 subscribers. Once the progress bar shows 100%, click on **OK & Next**.

---

**INFO:** Existing UC Smart or UC Smart AutoAttendant voicemail boxes are irrevocably deleted in the process.

---

## 4.7.10 Conference Server Settings

The **MeetMe Conference** settings window can be used to define the call numbers and the dial-in numbers for conferences.

### 4.7.10.1 How to Edit the Conference Server Settings

#### Prerequisites

- You are in the **Configure MeetMe Conference** window.

Configure MeetMe Conference

Call number: 444

Direct inward dialing: 445

(Number for Direct Inward Dialing)

### Step by Step

- 1) Enter a phone number for the conference in the **Phone Number** field.
- 2) Enter the dial-in number for the conference (conference DID) with which subscribers can dial into an existing conference in the **Direct inward dialing** field.
- 3) Click on **OK & Next**.

## 4.7.11 E-mail Delivery (Optional)

You can configure the delivery of e-mails in the **Configure E-Mail Forwarding** window. These e-mails notify users of voicemail and fax messages and administrators of system messages.

You have the following options:

- **Configuring the Sending of E-mails**  
You can specify an external E-mail server via which the e-mails are to be sent by OpenScape Business. Voicemails, fax messages and internal system messages can then be sent via this E-mail server to one or several different configurable e-mail addresses.

---

**INFO:** Entering the e-mail server is important if an e-mail with a link to the installation file(s) is to be automatically sent to the users of the UC Suite.

---

### 4.7.11.1 How to Configure the Sending of E-mails

#### Prerequisites

- An e-mail account with a password exists with an e-mail provider, and you know the access data for this account.
- You are in the **Configure E-Mail Forwarding** window.

The screenshot shows a configuration window with three sections:

- Server Information:** Outgoing Mail Server (SMTP) is set to `smtp.web.de`, and the Outgoing mail server port is `1234`. There is a checkbox for "This server requires an encrypted connection (TLS/SSL)" which is currently unchecked.
- Logon Information:** User Name is `max.mustermann.de`, Password is masked with dots, and Confirm Password is also masked with dots.
- User Information (Sender):** E-Mail Address is `max.mustermann@web.de`.

#### Step by Step

- 1) Enter the **Outgoing mail server (SMTP)** for the e-mail server to be used for sending e-mails, e.g., `smtp.web.de`. Ask your e-mail provider for the outgoing mail server if required.

---

**INFO:** Make sure that the name of the outgoing mail server can be resolved. If not, you must start the e-mail sending function via

**Service Center > E-mail Forwarding** and then enter the IP address of the outgoing mail server instead of its name.

---

- 2) If a secure connection is required, enable the corresponding check box. If required, check with your e-mail provider whether this option needs to be enabled.
- 3) Enter the **User Name** of the e-mail account, e.g.,: `john.doe`.
- 4) Enter the **Password** for the e-mail account and repeat it in the **Confirm Password** field.
- 5) Enter the **E-mail Address**, for example: `john.doe@web.de`.
- 6) If you want to test the entered e-mail settings immediately, proceed as follows:
  - a) Click on **Test Connection**.
  - b) Under **Send to e-mail address**, enter the e-mail address of any e-mail box that you can access. The test e-mail will be sent to that e-mail address.
  - c) Under **Subject in the e-mail**, enter a descriptive text so that you can identify the e-mail in your e-mail inbox.
  - d) Click on **Send Test E-mail**. The e-mail settings are verified, and the e-mail is sent to the specified e-mail address.
  - e) Check whether the e-mail has arrived in your e-mail inbox.
  - f) If the e-mail was sent correctly, proceed to the next step.
  - g) If the e-mail delivery failed, click **Back** and correct your e-mail settings.
- 7) Enter the **E-mail Address 1** to get a notification email when ALI tolerance has been used. You may also enter a second email address.
- 8) Click on **OK & Next** followed by **Finish**. The basic installation is finished. Before you perform the backup mentioned in the wizard, you should activate the licenses.

## 4.8 Closing Activities

After the initial installation and the basic installation with the WBM have been completed, some important settings must still be made for the operation of OpenScape Business.

Proceed as follows:

1. Activate and assign licenses  
The licenses procured with OpenScape Business must be activated within a period of 30 days. The time period begins the next time you log on to the WBM. After this time period expires, the communication system will only operate in restricted mode. Once the licenses have been activated successfully, they must be assigned to the stations and lines. In a standalone system, system-wide features are enabled automatically upon activation.

2. Provision the UC Smart client for installation (only for UC Smart)  
The UC Smart client myPortal Smart is a part of UC Smart. The installation file for myPortal Smart is accessible via the WBM and can be made available to the IP stations automatically or manually. For more information, see [UC Smart Clients](#).
3. How to Provision the UC Suite Clients for Installation (for UC Suite only)  
The UC Suite clients are part of UC Suite. The installation files for the UC Client are accessible via the WBM and can be made available to the IP stations automatically or manually.  
In addition, the administrator has the option of performing a silent installation. The silent installation/uninstallation is a command-line based method to automatically install, uninstall or modify UC Suite PC clients on a PC without requiring any further user inputs. For more information, see [Silent Installation/Uninstallation for UC Suite PC Clients](#).
4. Perform a data backup  
All previous changes to OpenScape Business must be backed up. The backup can be stored as a backup set on a USB storage device or in the internal network.

## 4.8.1 How to Activate and Assign the Licenses

### Prerequisites

- You are logged on to the WBM with the **Advanced** profile.
- You know the LAC (License Authorization Code) for releasing the license and have a user ID and password for accessing the license server.
- You need Internet access to connect to the license server.

### Step by Step

- 1) Activate license online:
  - a) In the navigation bar, click on **Setup**.
  - b) In the navigation tree, click **Wizards > Basic Installation**.
  - c) Click on **Edit** to start the **Licensing** wizard.

The screenshot shows a web-based wizard titled "Activate License Online". At the top, it displays "Licenses with Locking ID: 00-1a-e8-5d-ea-ff". Below this, there is a text input field for the "License Authorization Code (LAC)". A checkbox is checked, with the text "I have the user name and password for the License Server and want to log on." To the right of the checkbox. Below the checkbox, there are two more text input fields: "User name" and "Password". At the bottom of the form area, a red note states: "Note: The response from the License Server can take up to 90 seconds !".

**Initial Setup for OpenScope Business X**  
Closing Activities

- d) Enter the appropriate LAC in the **License Authorization Code (LAC)** field.
  - e) Select the check box **I have the user name and password for the License Server and want to log on.**
  - f) Enter the **User Name** and **Password** for logging into the License Server.
  - g) Click on **OK & Next**. The connection to the license server is established, and the licenses are released.
- 2) Assign licenses to stations:
- a) Click on **License Management** in the navigation bar.
  - b) In the navigation tree, navigate to the desired type of subscriber under **Local User Licenses > ...**. You will be shown a list of all subscribers of the selected subscriber type.
  - c) In the row of the desired subscriber, select the check box in the **User license** column (first column with check boxes).

Access	Call number	Name													
			<b>Remaining licenses</b>												
			5	5	5	0	0	0	0	0	0	0	0	0	0
LAN 0-SYS-9	110	Natalie Dubois	<input checked="" type="checkbox"/>	<input type="checkbox"/>	<input type="checkbox"/>	<input type="checkbox"/>	<input type="checkbox"/>	<input type="checkbox"/>	<input type="checkbox"/>	<input type="checkbox"/>	<input type="checkbox"/>	<input type="checkbox"/>	<input type="checkbox"/>	<input type="checkbox"/>	<input type="checkbox"/>
LAN 0-SYS-5	120	Pierre Martin	<input checked="" type="checkbox"/>	<input type="checkbox"/>	<input type="checkbox"/>	<input type="checkbox"/>	<input type="checkbox"/>	<input type="checkbox"/>	<input type="checkbox"/>	<input type="checkbox"/>	<input type="checkbox"/>	<input type="checkbox"/>	<input type="checkbox"/>	<input type="checkbox"/>	<input type="checkbox"/>
LAN 0-SYS-6	130	Claudia Ferraro	<input type="checkbox"/>	<input type="checkbox"/>	<input type="checkbox"/>	<input type="checkbox"/>	<input type="checkbox"/>	<input type="checkbox"/>	<input type="checkbox"/>	<input type="checkbox"/>	<input type="checkbox"/>	<input type="checkbox"/>	<input type="checkbox"/>	<input type="checkbox"/>	<input type="checkbox"/>
LAN 0-SYS-7	140	Giovanni Rossi	<input type="checkbox"/>	<input type="checkbox"/>	<input type="checkbox"/>	<input type="checkbox"/>	<input type="checkbox"/>	<input type="checkbox"/>	<input type="checkbox"/>	<input type="checkbox"/>	<input type="checkbox"/>	<input type="checkbox"/>	<input type="checkbox"/>	<input type="checkbox"/>	<input type="checkbox"/>
LAN 0-SYS-8	150	Carlos Alvarez	<input type="checkbox"/>	<input type="checkbox"/>	<input type="checkbox"/>	<input type="checkbox"/>	<input type="checkbox"/>	<input type="checkbox"/>	<input type="checkbox"/>	<input type="checkbox"/>	<input type="checkbox"/>	<input type="checkbox"/>	<input type="checkbox"/>	<input type="checkbox"/>	<input type="checkbox"/>
LAN 0-SYS-3	210	Emilia Gonzales	<input checked="" type="checkbox"/>	<input type="checkbox"/>	<input type="checkbox"/>	<input type="checkbox"/>	<input type="checkbox"/>	<input type="checkbox"/>	<input type="checkbox"/>	<input type="checkbox"/>	<input type="checkbox"/>	<input type="checkbox"/>	<input type="checkbox"/>	<input type="checkbox"/>	<input type="checkbox"/>
LAN 0-SIP-5	220	Paolo DaSilva	<input checked="" type="checkbox"/>	<input type="checkbox"/>	<input type="checkbox"/>	<input type="checkbox"/>	<input type="checkbox"/>	<input type="checkbox"/>	<input type="checkbox"/>	<input type="checkbox"/>	<input type="checkbox"/>	<input type="checkbox"/>	<input type="checkbox"/>	<input type="checkbox"/>	<input type="checkbox"/>
LAN 0-SIP-6	230	Ivan Vandenberg	<input checked="" type="checkbox"/>	<input type="checkbox"/>	<input type="checkbox"/>	<input type="checkbox"/>	<input type="checkbox"/>	<input type="checkbox"/>	<input type="checkbox"/>	<input type="checkbox"/>	<input type="checkbox"/>	<input type="checkbox"/>	<input type="checkbox"/>	<input type="checkbox"/>	<input type="checkbox"/>
LAN 0-SYS-4	240	Robert DeJoung	<input checked="" type="checkbox"/>	<input type="checkbox"/>	<input type="checkbox"/>	<input type="checkbox"/>	<input type="checkbox"/>	<input type="checkbox"/>	<input type="checkbox"/>	<input type="checkbox"/>	<input type="checkbox"/>	<input type="checkbox"/>	<input type="checkbox"/>	<input type="checkbox"/>	<input type="checkbox"/>
LAN 0-SYS-1			<input type="checkbox"/>	<input type="checkbox"/>	<input type="checkbox"/>	<input type="checkbox"/>	<input type="checkbox"/>	<input type="checkbox"/>	<input type="checkbox"/>	<input type="checkbox"/>	<input type="checkbox"/>	<input type="checkbox"/>	<input type="checkbox"/>	<input type="checkbox"/>	<input type="checkbox"/>
LAN 0-SIP-3			<input type="checkbox"/>	<input type="checkbox"/>	<input type="checkbox"/>	<input type="checkbox"/>	<input type="checkbox"/>	<input type="checkbox"/>	<input type="checkbox"/>	<input type="checkbox"/>	<input type="checkbox"/>	<input type="checkbox"/>	<input type="checkbox"/>	<input type="checkbox"/>	<input type="checkbox"/>
LAN 0-SIP-4			<input type="checkbox"/>	<input type="checkbox"/>	<input type="checkbox"/>	<input type="checkbox"/>	<input type="checkbox"/>	<input type="checkbox"/>	<input type="checkbox"/>	<input type="checkbox"/>	<input type="checkbox"/>	<input type="checkbox"/>	<input type="checkbox"/>	<input type="checkbox"/>	<input type="checkbox"/>
LAN 0-SIP-2			<input type="checkbox"/>	<input type="checkbox"/>	<input type="checkbox"/>	<input type="checkbox"/>	<input type="checkbox"/>	<input type="checkbox"/>	<input type="checkbox"/>	<input type="checkbox"/>	<input type="checkbox"/>	<input type="checkbox"/>	<input type="checkbox"/>	<input type="checkbox"/>	<input type="checkbox"/>

- d) Activate the user-oriented licenses in the row of the desired subscriber by selecting the appropriate check boxes.

Access	Call number	Name													
			<b>Remaining licenses</b>												
			5	5	5	0	0	0	0	0	0	0	0	0	0
LAN 0-SYS-9	110	Natalie Dubois	<input checked="" type="checkbox"/>	<input checked="" type="checkbox"/>	<input checked="" type="checkbox"/>	<input type="checkbox"/>	<input type="checkbox"/>	<input type="checkbox"/>	<input type="checkbox"/>	<input type="checkbox"/>	<input type="checkbox"/>	<input type="checkbox"/>	<input type="checkbox"/>	<input type="checkbox"/>	<input type="checkbox"/>
LAN 0-SYS-5	120	Pierre Martin	<input checked="" type="checkbox"/>	<input checked="" type="checkbox"/>	<input checked="" type="checkbox"/>	<input type="checkbox"/>	<input type="checkbox"/>	<input type="checkbox"/>	<input type="checkbox"/>	<input type="checkbox"/>	<input type="checkbox"/>	<input type="checkbox"/>	<input type="checkbox"/>	<input type="checkbox"/>	<input type="checkbox"/>
LAN 0-SYS-6	130	Claudia Ferraro	<input type="checkbox"/>	<input type="checkbox"/>	<input type="checkbox"/>	<input type="checkbox"/>	<input type="checkbox"/>	<input type="checkbox"/>	<input type="checkbox"/>	<input type="checkbox"/>	<input type="checkbox"/>	<input type="checkbox"/>	<input type="checkbox"/>	<input type="checkbox"/>	<input type="checkbox"/>
LAN 0-SYS-7	140	Giovanni Rossi	<input type="checkbox"/>	<input type="checkbox"/>	<input type="checkbox"/>	<input type="checkbox"/>	<input type="checkbox"/>	<input type="checkbox"/>	<input type="checkbox"/>	<input type="checkbox"/>	<input type="checkbox"/>	<input type="checkbox"/>	<input type="checkbox"/>	<input type="checkbox"/>	<input type="checkbox"/>
LAN 0-SYS-8	150	Carlos Alvarez	<input type="checkbox"/>	<input type="checkbox"/>	<input type="checkbox"/>	<input type="checkbox"/>	<input type="checkbox"/>	<input type="checkbox"/>	<input type="checkbox"/>	<input type="checkbox"/>	<input type="checkbox"/>	<input type="checkbox"/>	<input type="checkbox"/>	<input type="checkbox"/>	<input type="checkbox"/>
LAN 0-SYS-3	210	Emilia Gonzales	<input checked="" type="checkbox"/>	<input checked="" type="checkbox"/>	<input type="checkbox"/>	<input checked="" type="checkbox"/>	<input type="checkbox"/>	<input checked="" type="checkbox"/>	<input type="checkbox"/>	<input checked="" type="checkbox"/>	<input type="checkbox"/>	<input type="checkbox"/>	<input type="checkbox"/>	<input type="checkbox"/>	<input type="checkbox"/>
LAN 0-SIP-5	220	Paolo DaSilva	<input checked="" type="checkbox"/>	<input checked="" type="checkbox"/>	<input type="checkbox"/>	<input type="checkbox"/>	<input type="checkbox"/>	<input checked="" type="checkbox"/>	<input type="checkbox"/>	<input checked="" type="checkbox"/>	<input type="checkbox"/>	<input type="checkbox"/>	<input type="checkbox"/>	<input type="checkbox"/>	<input type="checkbox"/>
LAN 0-SIP-6	230	Ivan Vandenberg	<input checked="" type="checkbox"/>	<input checked="" type="checkbox"/>	<input type="checkbox"/>	<input type="checkbox"/>	<input type="checkbox"/>	<input checked="" type="checkbox"/>	<input type="checkbox"/>	<input checked="" type="checkbox"/>	<input type="checkbox"/>	<input type="checkbox"/>	<input type="checkbox"/>	<input type="checkbox"/>	<input type="checkbox"/>
LAN 0-SYS-4	240	Robert DeJoung	<input checked="" type="checkbox"/>	<input checked="" type="checkbox"/>	<input type="checkbox"/>	<input type="checkbox"/>	<input type="checkbox"/>	<input checked="" type="checkbox"/>	<input type="checkbox"/>	<input checked="" type="checkbox"/>	<input type="checkbox"/>	<input checked="" type="checkbox"/>	<input type="checkbox"/>	<input type="checkbox"/>	<input type="checkbox"/>
LAN 0-SYS-1			<input type="checkbox"/>	<input type="checkbox"/>	<input type="checkbox"/>	<input type="checkbox"/>	<input type="checkbox"/>	<input type="checkbox"/>	<input type="checkbox"/>	<input type="checkbox"/>	<input type="checkbox"/>	<input type="checkbox"/>	<input type="checkbox"/>	<input type="checkbox"/>	<input type="checkbox"/>
LAN 0-SIP-3			<input type="checkbox"/>	<input type="checkbox"/>	<input type="checkbox"/>	<input type="checkbox"/>	<input type="checkbox"/>	<input type="checkbox"/>	<input type="checkbox"/>	<input type="checkbox"/>	<input type="checkbox"/>	<input type="checkbox"/>	<input type="checkbox"/>	<input type="checkbox"/>	<input type="checkbox"/>
LAN 0-SIP-4			<input type="checkbox"/>	<input type="checkbox"/>	<input type="checkbox"/>	<input type="checkbox"/>	<input type="checkbox"/>	<input type="checkbox"/>	<input type="checkbox"/>	<input type="checkbox"/>	<input type="checkbox"/>	<input type="checkbox"/>	<input type="checkbox"/>	<input type="checkbox"/>	<input type="checkbox"/>
LAN 0-SIP-2			<input type="checkbox"/>	<input type="checkbox"/>	<input type="checkbox"/>	<input type="checkbox"/>	<input type="checkbox"/>	<input type="checkbox"/>	<input type="checkbox"/>	<input type="checkbox"/>	<input type="checkbox"/>	<input type="checkbox"/>	<input type="checkbox"/>	<input type="checkbox"/>	<input type="checkbox"/>

**INFO:** User-oriented licenses can be assigned to a subscriber only if a station license (user license) was assigned to the subscriber earlier (step c).

- e) Click on **OK & Next**. A check is performed to determine whether there are enough licenses for your assignment.  
  
If sufficient licenses are available, the licensing of the subscriber is completed.
  - f) If licenses are missing, the errors are indicated by displaying a check box shaded in red. Correct these errors and repeat step e.
- 3) Assign licenses to trunks:
- a) In the navigation tree, click **CO trunks**. The number of trunk licenses purchased will be displayed in the **CO trunks** area.
  - b) For SIP trunks: In the **License demand for number of simultaneous Internet calls in this node** area, enter the number of Internet calls that can be conducted simultaneously via an ITSP.
  - c) For S<sub>2M</sub> trunks: In the **S2M** area, in the row of the desired slot, select the number of desired B-channels in the drop-down list of the **Demands** column.
  - d) For T1 trunks (only for the U.S.): In the **T1** area, in the row of the desired slot, select the number of desired B-channels in the drop-down list of the **Demands** column.
  - e) Click on **OK & Next**.

---

**INFO:** The number of licensed SIP trunks and S<sub>2M</sub>/T1 trunks must not exceed the number of trunk licenses purchased.

---

## 4.8.2 How to Provision the UC Smart Client for Installation

### *Prerequisites*

- You are logged on to the WBM with the **Advanced** profile.
- The hardware and software for using UC Smart are available.

---

**INFO:** Licenses are required to use the UC Smart client myPortal Smart.

---

### *Step by Step*

- 1) Click on **Service Center** in the navigation bar.
- 2) Click on **Software** in the navigation tree.
- 3) Click on the Download icon of **myPortal Smart** and save the installation file on a shared network drive.
- 4) Click on the link icon for **Adobe AIR** and download the installation file to a shared network drive.

- 5) Send the two installation files to the users of myPortal Smart.
- 6) Alternatively, you can also send the users of myPortal Smart two links with which they can access the installation files:

```
https://<IP address of the communication system>/  
management/downloads/SmartClient.air  
http://www.adobe.com/air
```

### 4.8.3 How to Provision the UC Suite Clients for Installation

#### Prerequisites

- You are logged on to the WBM with the **Advanced** profile.
- The hardware and software for using the UC Suite are available.

---

**INFO:** Licenses are required to use the UC Suite clients.

---

#### Step by Step

- 1) To enable the installation files to be provided automatically to a station, make sure that the following steps have been performed:
  - a) The e-mail addresses of the stations and the associated subscriber data must have either been already imported via an XML file or entered later under **Setup > UC Suite > User Directory**.
  - b) An e-mail server must have been specified.

---

**INFO:** You can also enter an E-mail server later under **Service Center > E-mail Forwarding**.

---

All subscribers whose e-mail addresses are known receive an e-mail with a link to the installation directory of the UC clients and Getting Started Instructions. The installation folder also includes a Readme file with information on installing the software on client PCs.

- 2) If the required steps for automatic notification are not fulfilled, you can also make the installation files available manually. To do this, proceed as follows:
  - a) Click on **Service Center** in the navigation bar.
  - b) Click on **Software** in the navigation tree.
  - c) Click on the desired UC client and save the zipped installation file on a shared network drive.
  - d) Click in the navigation tree on **Documents** and select **User Guide** from the drop-down list.
  - e) Click on the documentation of the desired UC client and save the documentation file on a shared network drive.



- f) Send the zipped installation file and the documentation file to the users of the UC clients by e-mail or inform the users about the storage location of these files.
- g) The zip file with the installation files also includes a Readme file. Notify the users that the installation of the UC clients must be performed in accordance with the installation notes in the Readme file.
- 3) Alternatively, you can also send the UC users links through which they can directly access the installation files of the UC clients.
  - a) Click on **Service Center** in the navigation bar.
  - b) Click on **Software** in the navigation tree.
  - c) Click on the **Show Application Links** button. You will be presented with multiple links, depending on the used operating system and the desired UC client. For example:

```
https://<IP address of the communication system>/  
management/downloads/install-common.zip
```

## 4.8.4 How to Perform a Data Backup

### *Prerequisites*

- You are logged on to the WBM with the **Advanced** profile.
- For a backup to a USB storage device (USB stick or USB hard disk), the USB device must be connected to the USB server port.

---

**INFO:** For more information on backing up data, see [Immediate Backup](#).

---

### *Step by Step*

- 1) Click on **Backup and Restore** in the navigation bar.
- 2) In the navigation tree, click **Backup - Immediate**.
- 3) Enter a comment for the backup set in the **Comment** field in the **Name** area so that the backup set can be easily identified if needed later for a restore. Avoid the use of diacritical characters such as umlauts and special characters in your input.
- 4) Activate the target drive on which the backup set is to be saved in the **Devices** area.
- 5) Click on **OK & Next**. The progress of the backup process is displayed in a separate window.
- 6) The backup was successful if the message **Backup completed successfully!** appears. Click on **Finish**.

- 7) If you are using a USB stick as the backup medium, wait until the LED of the USB stick stops blinking. This ensures that the backup has been successfully saved on the USB stick. You can then safely remove the USB stick.
- 8) This completes the initial startup with WBM. Exit the WBM by right-clicking the **Logout** link on the top right of the screen and then close the window.

---

**INFO:** If a new software version for the communication system is available, you will be notified about this on the home page of the WBM, provided the Internet connection was set up correctly. If a new software version is available, perform an update (see [Updating the Communication System](#)).

---

## 4.9 Commissioning of IP Phones

The commissioning of IP phones can be facilitated by the existence of a DHCP server that supplies an IP phone with important (network-specific) data that is needed to log into the communication system.

### Network-Specific Data

In order to log into the communication system, an IP phone requires some network-specific data. This data can be stored in the DHCP server or be entered directly at the IP phone. The advantage of a DHCP server is that all connected IP phones are automatically supplied with the relevant data.

The following data is required by the IP phone:

- IP address of the communication system
- IP address of DLS server

In addition, the IP phone needs its own call number. This must be entered manually when logging in at the phone.

### Registration of SIP Phones

For security reasons, it is recommended that SIP phones register at the communication system. To do this, the registration information on the IP phone and the communication system must match.

The following data is required for the login:

- SIP user ID
- SIP password
- SIP realm (optional)

Use a non-trivial SIP password that complies with the following rules:

- At least 8 characters
- At least one uppercase letter (A - Z)
- At least one lowercase letter (a - z)
- At least one digit (0-9)

- At least one special character

Use a SIP user ID that does not include the phone number.

---

**INFO:** More information on configuring SIP telephones can be found at [http://wiki.unify.com/wiki/SIP\\_devices\\_configuration\\_examples](http://wiki.unify.com/wiki/SIP_devices_configuration_examples).

---

### Using the Internal DHCP Server

If the internal DHCP server of the communication system is used, the network-specific data will already be stored there. In order to enable an IP phone to register at the communication system, only the specified call number must be entered at the IP phone. In the case of SIP phones, the SIP registration data at the SIP phone and at the communication system must match.

### Using an External DHCP Server with Network-specific Data

If an external DHCP server is used, the network-specific data must be stored there. In order to enable an IP phone to register at the communication system, only the specified call number must be entered at the IP phone. In the case of SIP phones, the SIP registration data at the SIP phone and at the communication system must match.

### Using an External DHCP Server without Network-specific Data

If an external DHCP server in which the network-specific data cannot be stored is used, this must be entered at the IP phone. To enable an IP phone to register at the communication system, the defined call number and IP address of the communication system must be entered at the phone, and the settings for the Deployment Service may need to be changed. In the case of SIP phones, the SIP registration data at the SIP phone and at the communication system must match.

## 4.9.1 How to Configure an IP Phone

### *Prerequisites*

- The IP phone is connected to the internal network and operational.

---

**INFO:** The sample configuration described here uses an OpenStage 40/60/80 IP system telephone. The same settings must also be made for any other IP phone. For more information, refer to the manual supplied with your IP phone.

---

### **Step by Step**

- 1) To reach the administration mode of the IP system telephone, press the appropriate key for the Settings/Applications menu on the phone.
- 2) Scroll through the `Settings` options until `Admin` and confirm this with the OK key.
- 3) Enter administrator password (123456 by default) and confirm your selection with the OK key.
- 4) If you are using the DHCP server of the communication system in the internal network, skip the next step.
- 5) If you are not using the DHCP server of the communication system in the internal network, you will need to enter the IP addresses of the Deployment Server (DLS) and the communication system so that the software of the IP system telephone can be updated automatically. This applies only to IP system telephones. Proceed as follows:
  - a) Scroll to `Network` and confirm your selection with the OK key.
  - b) Scroll to `Update service (DLS)` and confirm your selection with the OK key.
  - c) Scroll to `DLS address` and confirm your selection with the OK key.
  - d) Specify the IP address of the communication system (192.168.1.2 by default) as the Deployment Server and confirm your entry with the OK key.
  - e) Scroll to `Save & Exit` and confirm your selection with the OK key.
  - f) Scroll to `IPv4 configuration` and confirm your selection with the OK key.
  - g) Scroll to `Route (default)` and confirm your selection with the OK key.
  - h) Specify the IP address of the communication system ( 192.168.1.2 by default) and confirm your entry with the OK key.
  - i) Scroll to `Save & Exit` and confirm your selection with the OK key.
  - j) Navigate one menu level back with the Back key.
- 6) Specify the call number of the phone:
  - a) Scroll to `System` and confirm your selection with the OK key.
  - b) Scroll to `Identity` and confirm your selection with the OK key.
  - c) Scroll to `Terminal number` and confirm your selection with the OK key.
  - d) Enter the set phone number (e.g., 120) and confirm your selection with the OK key.
  - e) Scroll to `Save & Exit` and confirm your selection with the OK key.
- 7) Navigate one menu level back with the Back key.
- 8) If the system telephone needs to be restarted due to the changes made, the menu item `Restart` will appear in the `Admin` menu. Confirm the `Restart`

with the OK key and then also confirm `Yes` with the OK key. The system telephone performs a reboot and logs in to the communication system.

## 4.9.2 How to Configure a SIP Phone

### Prerequisites

- The SIP phone is connected to the customer LAN and operational.

---

**INFO:** The configuration described here uses an OpenStage 40/60/80 SIP system telephone as an example. The same settings must also be made for another SIP phone. For more information, refer to the manual supplied with your SIP phone.

---

### Step by Step

- 1) To reach the administration mode of the SIP system telephone, press the appropriate key for the `Settings/Applications` menu on the phone.
- 2) Scroll through the `Settings` options until `Administrator (Admin)` and confirm this with the OK key.
- 3) Enter administrator password (`123456` by default) and confirm your selection with the OK key.
- 4) If you are using the DHCP server of the communication system in the internal network, skip the next step.
- 5) If you are not using the DHCP server of the communication system in the internal network, you will need to enter the IP addresses of the Deployment Server (DLS) and the communication system so that the software of the SIP system telephone can be updated automatically. This applies only to SIP system telephones. Proceed as follows:
  - a) Scroll to `Network` and confirm your selection with the OK key.
  - b) Scroll to `Update service (DLS)` and confirm your selection with the OK key.
  - c) Scroll to `DLS address` and confirm your selection with the OK key.
  - d) Specify the IP address of the communication system (`192.168.1.2` by default) as the Deployment Server and confirm your entry with the OK key.
  - e) Scroll to `Save & Exit` and confirm your selection with the OK key.
  - f) Scroll to `IPv4 configuration` and confirm your selection with the OK key.
  - g) Scroll to `Route (default)` and confirm your selection with the OK key.
  - h) Specify the IP address of the communication system ( `192.168.1.2` by default) and confirm your entry with the OK key.
  - i) Scroll to `Save & Exit` and confirm your selection with the OK key.

- j)* Navigate one menu level back with the Back key.
- 6)** Specify the SNTP time settings:
- a)* Scroll to `Date and time` and confirm your selection with the OK key.
  - b)* Scroll to `Time source` and confirm your selection with the OK key.
  - c)* Scroll to `SNTP IP address` and confirm your selection with the OK key.
  - d)* Specify the IP address of the communication system ( `192.168.1.2` by default) and confirm your entry with the OK key.
  - e)* Scroll to `Timezone offset` and confirm your selection with the OK key.
  - f)* Enter the deviation between the local time and UTC (Universal Time Coordinated) in hours (Germany: `1`) and confirm this with the OK button.
  - g)* Scroll to `Save & Exit` and confirm your selection with the OK key.
  - h)* Navigate one menu level back with the Back key.
- 7)** Specify the call number of the phone:
- a)* Scroll to `System` and confirm your selection with the OK key.
  - b)* Scroll to `Identity` and confirm your selection with the OK key.
  - c)* Scroll to `Terminal number` and confirm your selection with the OK key.
  - d)* Enter the set phone number (e.g., `120`) and confirm your selection with the OK key.
  - e)* Scroll to `Save & Exit` and confirm your selection with the OK key.
- 8)** Specify the SIP authentication data:
- a)* Scroll to `Registration` and confirm your selection with the OK key.
  - b)* Scroll to `SIP Session` and confirm your selection with the OK key.
  - c)* Note the `Realm`, or enter a new realm (e.g., `OSBIZ-SIP`), if necessary.
  - d)* Note the `User ID`, or enter a new user ID (e.g., `SIP-120`), if necessary.
  - e)* Specify a `Password` for registering at the SIP server.
  - f)* Scroll to `Save & Exit` and confirm your selection with the OK key.
- 9)** Use the Back key to go back to the `Admin` menu.
- 10)** If the system telephone needs to be restarted due to the changes made, the menu item `Restart` will appear in the `Admin` menu. Confirm the `Restart` with the OK key and then also confirm `Yes` with the OK key. The system telephone performs a reboot and logs in to the communication system.

## 5 Initial Setup for OpenScape Business S

The initial setup of OpenScape Business S (also referred to as the Softswitch in short) is described here. This includes the integrating the softswitch and related components into the existing customer LAN as well as setting up Internet access for Internet telephony and configuring the connected stations.

For OpenScape Business S, the OpenScape Business communication software is installed on the Linux operating system SLES 11 SP4 64 Bit. The communication software can be operated directly on a Linux server or in a virtual environment with VMware vSphere or Microsoft Hyper-V. The installation of the Linux operating system is described in the installation guide *OpenScape Business, Installing the Linux Server*.

The initial setup of OpenScape Business S is carried out using the OpenScape Business Assistant administration program (web-based management, also called WBM in short).

This section describes the configuration of the most common components. Not all of these components may be used by you. During the initial setup, you may need to choose between multiple options in some places or even skip some configurations entirely, depending on which components you use.

The detailed administration of any features that are not covered by the initial setup is described in subsequent chapters.

The initial setup requires the creation of an IP address scheme and a dial plan.

Summary of the most important installation steps:

- System settings
- System Phone Numbers and Networking
- Internet Telephony
- Station configuration
- Licensing
- Data backup

### 5.1 Prerequisites for the Initial Setup

Meeting the prerequisites for the initial setup ensures the proper operation of OpenScape Business S.

#### General

Depending on the used hardware (phones, ...) and the existing infrastructure, the following general conditions apply:

- The LAN infrastructure (Internet routers, switches, etc.) is present and usable.
- The IP phones are connected to the customer LAN.

## Initial Setup for OpenScape Business S

### Prerequisites for the Initial Setup

- The Linux server required for OpenScape Business S was installed as per the instructions in the *OpenScape Business Linux Server Installation Guide*, was integrated into the customer LAN, and is ready for use.
- All licenses required for OpenScape Business S are present (e.g., UC clients, Gate View, Directory Services, etc.).
- An IP address scheme exists and is known.
- A dial plan (also called a numbering plan) is present and known.

### Software

The following software is required for the installation of OpenScape Business S:

- DVD or .ISO image with the OpenScape Business communication software  
Contains the OpenScape Business communication software. This DVD or .ISO image is included in the delivery package.
- DVD with Linux operating system SLES 11 SP4 64 bit  
The Linux DVD may be needed during the installation of the OpenScape Business communication software, since some software packages (RPM) required for the communication software may need to be installed later from this DVD or .ISO image.

### Administration

For the initial setup of OpenScape Business S with the OpenScape Business Assistant (WBM), the Linux server or the Admin PC can be used. The WBM is browser-based and is thus independent of the operating system.

- Web browsers:  
The following HTML 5-enabled web browsers are supported:
  - Microsoft Internet Explorer Version 11 and later (Admin PC).
  - Mozilla Firefox Version 37.x and 38.x
  - Mozilla Firefox ESR Version 24.x and 31.x
  - Google ChromeIf an older version of the web browser is installed, you will need to install an up-to-date version before you can start the initial setup of the system.
- Oracle Java:  
The latest version of Oracle Java must be installed. If an older version is installed, you will need to update it to the latest version before you can start setting up the system for the first time.
- Screen resolution: 1024x768 or higher

### Firewall

When connected to the Internet, a firewall is needed for the Linux server to prevent unauthorized access from outside. After installing Linux, the Linux firewall is enabled. The installer of the communication software adjusts the firewall settings so that the communication software can be operated properly. The ports for the communication software are opened, and all other ports are closed.

If an external firewall is used in the network, the Linux firewall must be disabled, and the addresses and ports required for the communication software must be opened (see [Used Ports](#)).



### Internet Access

The Server PC must have broadband Internet access for:

- Security patches and general Linux software updates

OpenScape Business requires an Internet connection for:

- OpenScape Business software updates
- OpenScape Business features such as Internet telephony, for example
- OpenScape Business Mobility Clients such as myPortal to go, for example
- Remote Service

### E-mail Server (Optional)

OpenScape Business requires access to an e-mail server in order to send e-mails. For this purpose, the access data to the E-mail server must be entered in OpenScape Business, and the relevant accounts (IP address, URL, login data of the E-mail server) must be set up in the E-mail server.

If the e-mail functionality is not used within OpenScape Business, this data need not be entered.

### Internet Telephony, VoIP (Optional)

If Internet telephony is used within OpenScape Business, then OpenScape Business will require broadband access to the Internet and to an Internet Telephony Service Provider (ITSP, SIP Provider) for SIP telephony over the Internet. To do this, the appropriate accounts must be obtained from the ITSP, and the access data for the ITSP (IP address, URL, login data of the SIP Provider) must be set up in OpenScape Business.

### Second LAN Port

If OpenScape Business S (or the Linux server) has a second LAN port, you can use this as a WAN interface for Internet access and Internet telephony via an ITSP. The first LAN port is used as usual as a LAN interface for the internal phones and PCs. The configuration of Internet access occurs in the external Internet router of the customer LAN. The setup of the second LAN port occurs directly during the initial setup of Linux or can be performed later using YaST. In the WBM, the second LAN port only needs to be activated as a WAN interface.

### Fax as PDF

If faxes are to be saved in PDF format, the server PC requires at least 4 GB RAM. If OpenScape Business S is being operated in a virtual environment, the virtual machine must also be assigned 4GB RAM.

## 5.2 Components

The various components of the installation example are described and outlined below.

The installation example includes the following components:

## Initial Setup for OpenScape Business S

### IP Address Scheme

- **OpenScape Business S**  
The Linux server with the OpenScape Business S communication software is integrated in the existing customer LAN via its LAN interface.
- **Admin PC**  
The admin PC is also integrated in the existing customer LAN via its LAN interface.
- **IP stations (IP clients)**  
The IP stations (IP system phones, client PCs, WLAN Access Points, etc.) are integrated in the LAN via one or more switches.

The IP clients obtain their IP addresses dynamically from an internal DHCP server (DHCP server of the Linux server) or from an external DHCP server (DHCP server of the Internet router, for example).

Internet access is configured in the Internet router.

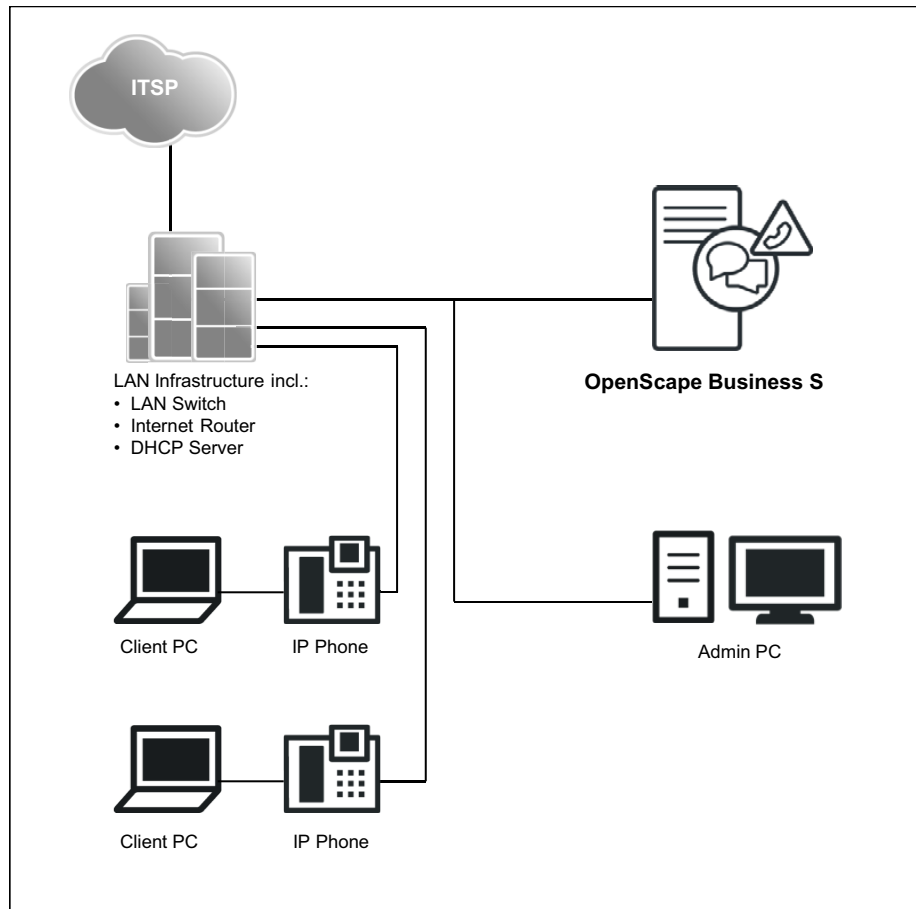

## 5.3 IP Address Scheme

An IP address scheme is a definition of how the IP addresses are used in the customer LAN. It includes the IP addresses of PCs, servers, Internet routers, IP phones, etc.

To provide a better overview of the assignment of IP addresses, an IP address scheme should be created.

Example of an IP address scheme with the IP address range 192.168.5.x:

IP address range	Clients
<b>192.168.5.1 through 192.168.5.49</b>	Clients with a fixed IP address
192.168.5.1	Internet router (gateway)
192.168.5.10	Server PC (OpenScape Business S)
192.168.5.20	E-mail server
<b>192.168.5.100 to 192.168.5.254</b>	Client PCs & IP phones, also the IP address range of the DHCP server; IP addresses are assigned automatically to the clients

## 5.4 Dial Plan

A dial plan is a list of all phone numbers available in the communication system. It comprises internal phone numbers, DID numbers, and group station numbers.

### Default Dial Plan

The internal call numbers are preassigned default values. These values can be adapted to suit individual requirements as needed (e.g., to create individual dial plans).

Extract from the default dial plan:

Type of call numbers	Default call numbers
Internal station numbers	100-349, 500-709
User direct inward dialing numbers	100-349, 500-709
Group station numbers	350-439
Voicemail call number	71
Announcement Player call number	72
Seizure codes (external codes):	
Central Office ITSP	855-858
Call number for conferences	7400-7404
Call number for parking	7405
Call number for AutoAttendant	7410-7429
Call number for MeetMe conference	7430

### **Individual Dial Plan**

An individual dial plan can be imported in the WBM via an XML file during the basic configuration.

The XML file contains several tabs. Besides the names and phone numbers of subscribers, the "Customer" tab also includes additional subscriber data such as the subscriber types and e-mail addresses of the subscribers.

A sample XML file with the appropriate explanations can be found in the WBM under **Service Center > Documents > Templates > CSV Templates**. You can also use the XML file stored there as a template for your data. It can be edited with Microsoft Excel, for example.

## **5.5 Installing the Communication Software**

The OpenScape Business S communication software is installed on the Linux server.

Make sure that the IP addresses and network masks to be configured are appropriate for the customer LAN.

### **DHCP Server**

A DHCP server automatically assigns a unique IP address to each IP station (IP phones, PCs, etc.) and provides the IP stations with network-specific data such as the IP address of the default gateway, for example.

Either an external DHCP server (e.g., the DHCP server of the Internet router or of the communication system) or the DHCP server of the Linux server can be used as a DHCP server. If the DHCP server of the Linux server is used, the external DHCP server must be disabled. The configuration of the Linux DHCP server can be performed during the installation of the OpenScape Business communication software.

### **Virtual Environment**

The communication software can run in a virtual environment. There are two ways to perform the installation:

- **Separate installation of Linux and the communication software**  
To do this, the virtualization software (host operating system) must be first installed and configured on the server PC. Linux is installed in the virtual environment as a guest operating system. Within the Linux operating system, the communication software is installed last with the help of the OpenScape Business DVD or .ISO file (see *OpenScape Business Linux Server, Installation Guide* for more details).
- **Combined installation of Linux and the communication software (VMWare only)**  
To do this, the virtualization software (host operating system) must be first installed and configured on the server PC. An OVA image (Open Virtualization Appliance), which includes Linux and the communication software, is installed

in the virtual environment. The OVA image is provided through the software supply server (SWS).

For more than 50 users, the home partition must be resized after the installation to 100 GB (for 50 to 100 users) or 200 GB (for up to 500 users or for OpenScape Business Contact Center) or 500 GB (for more than 500 users).

For Linux updates, you will also need the OpenScape Business SLES upgrade key in order to be able to register with Linux.

Use of snapshots on virtual machines (VM):

Snapshots can be a valuable maintenance mechanism, for example, to perform a fast rollback to a predefined operating state of the VM after a mass distribution script has failed.

- Snapshots cannot be created during normal operation. The current operating state of the virtual machine is frozen while taking a snapshot. Consequently, connected terminals and applications such as IP phones or the UC clients may lose the connection to the server.
- Snapshots can cause internal server processes to lose their synchronization, which means that the stable operation of the communication system can then no longer be guaranteed. A server reboot following the snapshot should therefore also be planned within the maintenance timeframe.
- Previous snapshots should not remain on the production environment during normal operation.
- Snapshots can be taken during a planned maintenance window or within the framework of the installation.
- Snapshots are used internally by backup tools such as VDP or VDR. It must be ensured that these backup operations are scheduled outside of business hours and that the snapshots generated by these tools are deleted at the end of the operation.

More information regarding snapshots can be found in the VMware knowledge base (KB). A good starting point is the KB article 1025279 – Best Practices for virtual machine snapshots in the VMware environment (<http://kb.vmware.com/kb/1025279>).

All information about snapshots in Microsoft Hyper-V can be found in the technet library at [technet.microsoft.com](http://technet.microsoft.com) within the Hyper-V chapter.

## 5.5.1 How to Install the Communication Software

### *Prerequisites*

- The SLES 11 SP4 64 bit operating system has been correctly installed and started on the Linux server.
- DVD or .ISO file with OpenScape Business communication software.
- DVD or .ISO file with the Linux operating system SLES 11 SP4 64 bit for any subsequent installation of software packages (RPM) that may be required.
- The root access data (user name and password) for logging into the Linux server is available.

---

**IMPORTANT:** The OpenScape Business communication software overwrites any existing configuration files (e.g., for DHCP, FTP, Postfix, etc.) during the installation.

---

### *Step by Step*

- 1) Log into the Linux server with root privileges.
- 2) Insert the OpenScape Business DVD or .ISO file into the DVD drive.
- 3) Confirm the message with **Run**. The "Welcome" window appears.
- 4) Select the desired setup language (e.g., **English**) and click **Start**. The rest of the installation is described here for the English language.
- 5) Select the desired product from the list and click on **Select**. A check is performed to determine whether the hardware meets all the requirements for the installation. A warning is displayed for minor shortfalls in meeting the requirements. After confirmation, the installation can then be continued. For severe shortfalls, the installation is canceled automatically.
- 6) A check is performed to determine whether additional RPM packages need to be installed. If yes, confirm this with **Confirm**. If this occurs, you will need to switch back to the SLES 11 DVD or .ISO file later.
- 7) A window with the terms of the license (i.e., the End User License Agreement or EULA) appears. Read the terms of the license and accept the license agreement with **Yes**.
- 8) If a DHCP server is already present in the customer LAN (e.g., the DHCP server of the Internet router), stop the configuration of the Linux DHCP server here with **No** and proceed to step [12](#) to continue.

---

**INFO:** In order to ensure that the software of system telephones can be updated automatically even when using an external DHCP server, you have two options:

a) The IP address of the Linux server must be entered as the DLS address at each system telephone.

b) The network-specific data must be entered at the external DHCP server. The parameters for this can be found under `/var/log/OPTI.txt`.

---

9) If you want to use the Linux DHCP server, click on **Yes** to enable and configure the Linux DHCP server.

10) Enter the following values (preset with default values):

- **Default Route:** IP address of the default gateway; as a rule, the IP address for the Internet router, e.g., 192.168.5.1.
- **Domain** (optional): the domain specified during the Linux installation, e.g., <customer>.com
- **DNS-Server** (optional): IP address of the DNS server specified during the Linux installation. If no DNS server is available in the internal network, you can enter the IP address of the Internet router (e.g., 192.168.5.1) here.
- **SNTP Server:** IP address of the internal or external NTP server.
- **DLS/DLI Server:** IP address of DLS server, i.e., the IP address of the Linux server (e.g.: 192.168.5.10).
- **Subnet:** appropriate subnet for the IP address range, e.g.: 192.168.5.0.
- **Netmask:** Subnet mask of the Linux server that was specified during the Linux installation, e.g.: 255.255.255.0.
- **IP range begin** and **IP range end:** IP address range from which the DHCP server may assign IP addresses, e.g.: 192.168.5.100 to 192.168.5.254.

11) Click on **Continue**.

12) After the installation, the Linux operating system needs to be restarted. Select the check box **PC Reboot** and confirm with **Continue**.

13) If additional RPM packages need to be installed, you will be prompted to insert the SLES 11 DVD or .ISO file. Insert the DVD or .ISO file and confirm with **Continue**. Following the successful installation of the RPM packages, reinsert the OpenScape Business DVD or .ISO file and confirm this with **Continue**, followed by **Run**.

14) The OpenScape Business communication software is installed. The operating system then automatically performs a restart.

15) After the restart, log in with the user account that was set up earlier during the Linux installation.

- 16) Right-click on the DVD drive icon on the desktop and select the menu item **Eject**. Remove the OpenScape Business DVD from the DVD drive.

---

**INFO:** It takes a few minutes until all components of the OpenScape Business communication software are active. Using the OpenScape Observer, you can check when the OpenScape Business communication software is ready for use.

---

## 5.6 Function Check with the OpenScape Observer

The OpenScape Observer program can be used to check whether OpenScape Business is operational.

OpenScape Observer can be started from the Admin PC or from a client PC in the internal network. To do this, the program must be copied from the Service Center of the WBM to the PC.

### 5.6.1 How to Copy OpenScape Observer to the PC

#### *Prerequisites*

- The OpenScape Business communication software is installed.
- The latest Oracle Java version is installed on the PC.

#### *Step by Step*

- 1) Start the web browser on the PC and open the login page of the WBM at the following address:

`https://<IP address of the Linux server>, e.g., https://192.168.5.10.`

- 2) If the browser reports a problem with a security certificate, install the certificate (using the example of Internet Explorer V10).
  - a) Close the web browser.
  - b) Open the web browser with administrator rights by clicking the right mouse button on the web browser icon and selecting the menu item **Run as administrator** from the context menu.
  - c) Allow the User Account Control.
  - d) Open the login page of the WBM at the following address:

`https://<IP address of the Linux server>, e.g., https://192.168.5.10.`
  - e) Click on **Continue to this website**.
  - f) Click on the message **Certificate Error** in the navigation bar of the web browser.



- g)* Click on **View Certificates**.
  - h)* Click on **Install Certificate** (only visible with administrator rights).
  - i)* Select the option **Local Computer** and confirm with **Next**.
  - j)* Select the option **Place all certificates in the following store**, click **Browse** and specify **Trusted Root Certification Authorities**.
  - k)* Confirm with **OK** and then with **Next** and **Finish**.
  - l)* Confirm the certificate import with **OK** and close the certificate window **OK**.
  - m)* Close the web browser.
  - n)* Start the web browser again (without administrator rights) and open the login page of the WBM at the following address:  
  
`https://<IP address of the Linux server>, e.g., https://192.168.5.10.`
- 3) Click on the language code at the top right and select the language in which the user interface of the WBM is to be displayed from the menu. The Login page will be displayed in the selected language.
- 4) In the field under **Login**, enter the default user name `administrator@system` for access as an administrator.

---

**INFO:** If you press the tab key after entering `administrator,`  
`@system` will be added automatically.

---

- 5) In the second field under **Login**, enter the default password `administrator` for access as an administrator.
- 6) Click **Login**.
- 7) You are prompted to change the default password.
- a)* Reenter the default password **administrator** in the `Password` field.
  - b)* Enter a new password in the **New Password** and **Confirm New Password** fields to protect the system against misuse. Note case usage and the status of the **Num** key. The password is displayed as a string of asterisks (\*).

---

**INFO:** The password must be at least 8 characters long and include a digit. Make sure that you remember your new password.

---

- 8) Click **Login**.
- 9) Click **Service Center** on the navigation bar.
- 10) Click in the **Software** area on the item **OpenScape Observer**.
- 11) Save the file `OsoObserver.jar` on the PC in a directory of your choice.

## 5.6.2 How to Start OpenScape Observer from the PC

### *Prerequisites*

- The file `OsoObserver.jar` is stored on the client PC.

### *Step by Step*

- 1) Navigate on the PC to the storage path of OpenScape Observer.
- 2) Double-click on the file `OsoObserver.jar`. OpenScape Observer opens as a small window in the upper left corner of the screen.
- 3) Enter the IP address of the Linux server on which the OpenScape Business communication software is installed (e.g., `192.168.5.10`) in the field of the OpenScape Observer.
- 4) Click on **Connect OSO**.
- 5) Another window opens with the following contents:
  - IP address of the Linux server (in the header)
  - Version number of the installed OpenScape Business communication software
  - Version of the Linux server operating system
  - Utilization of the home partition (HD) and memory (RAM) of the Linux server as a percentage
  - Abbreviation of the installed product (e.g., `S` for OpenScape Business S and `B` for the UC Booster Server)
- 6) In the window you will also be informed about the status of OpenScape Business with an LED display:
  - Red LED: The OpenScape Business system components cannot be started - OpenScape Business is not ready for use
  - Yellow LED: The OpenScape Business system components have started - OpenScape Business is not yet ready for use
  - Green LED: The OpenScape Business system components have started - OpenScape Business is ready for use

## 5.7 Starting Up

The basic settings are made using the **Initial Installation** wizard of the WBM.

### 5.7.1 How to Start the Initial Installation Wizard

#### *Prerequisites*

- The WBM has been started.

### Step by Step

- 1) In the navigation bar, click on **Setup**.
- 2) Click on **Edit** to start the **Initial Installation** wizard.

---

**INFO:** If the size of the browser window cannot display the workspace in its entirety at low screen resolutions, a horizontal or vertical scroll bar appears at the sides and can be used to scroll to the required section.

---

### Next steps

Perform initial installation as described in the following step-by-step instructions. Fields that are not described here are preset for the default scenario and should only be changed if they are not appropriate for your network data. For detailed information, refer to the descriptions provided in the Administrator documentation for the individual wizards.

## 5.7.2 System Settings

The **System Settings** window is used to configure the system settings of the communication system.

Proceed as follows:

1. Set the display logo and the product name  
Specify a display text to be displayed on the display of the system phones. Additionally, you can also select the product name.
2. Select the country code and the language to be used for event logs  
For country initialization to work correctly, you must select the country in which the communication system is operated. In addition, you can select the language in which the event logs (system event logs, errors logs, etc.) are to be stored.
3. Only if required: Activate another LAN port as a WAN interface  
If OpenScape Business S (or the Linux server) has a second LAN port, you can use this as a WAN interface for Internet access and Internet telephony via an ITSP. The first LAN port is used as usual as a LAN interface for the internal phones and PCs.

### 5.7.2.1 How to Set the Display Logo and the Product Name

#### Prerequisites

- You are in the **System Settings** window.

## Initial Setup for OpenScape Business S Starting Up

The screenshot shows the 'System Settings' window. At the top, there are two fields: 'Display Logo' with the value 'OS Business S' and a clear button (x), and 'Brand' with a dropdown menu showing 'OpenScape Business'. Below this, there are three sections: 'OpenScape Business' with IP address and Netmask fields for both local and WAN interfaces, and 'Language settings' with 'System Country Code' (Germany) and 'Language for Customer Trace Log' (English) dropdowns. A red box highlights the 'Display Logo' and 'Brand' fields.

### Step by Step

- 1) In the **Display Logo** field, enter a text of your choice (e.g., OS Business S). The text can contain up to 16 characters. Avoid the use of diacritical characters such as umlauts and special characters.
- 2) Select the desired time product name in the **Brand** drop-down list.

### Next steps

Select the country code - and language to be used for the event logs.

## 5.7.2.2 How to Select the Country Code and the Language for Event Logs

### Prerequisites

- You are in the **System Settings** window.

The screenshot shows the 'System Settings' window. The 'System Country Code' dropdown is set to 'Germany' and the 'Language for Customer Trace Log' dropdown is set to 'English'. A red box highlights these two fields.

### Step by Step

- 1) In the **System Country Code** drop-down list, select the country where the communication system is operated.
- 2) In the **Language for Customer Event Log** field, enter the language in which the event logs (system event logs, error logs, etc.) are to be output.

### Next steps

Start the basic configuration.

## 5.7.2.3 How to Activate an Additional LAN Port as a WAN Interface

### Prerequisites

- You are in the **System Settings** window.

The screenshot shows the 'System Settings' window. It is divided into three sections: 'OpenScape Business', 'Language settings', and 'System Settings'. In the 'OpenScape Business' section, there are fields for 'OpenScape Business - IP address' (192.168.5.2 - eth0) and 'OpenScape Business - Netmask' (255.255.0.0). Below these, the 'WAN' checkbox is checked. Underneath, there are fields for 'OpenScape Business - IP address (WAN)' (192.168.5.5 - eth1) and 'OpenScape Business - Netmask (WAN)' (255.255.0.0). A red box highlights the 'WAN' checkbox and the two WAN-related fields. The 'Language settings' section shows 'System Country Code' set to 'Germany' and 'Language for Customer Trace Log' set to 'English'.

### Step by Step

- 1) Select the **WAN** check box.
- 2) Select the desired LAN port (e.g., `eth1` or `eth2`) from the **OpenScape Business - IP Address (WAN)** drop-down list. If only two LAN ports are available, the second LAN port `eth1` is activated automatically.

---

**INFO:** The assignment of IP addresses and subnet masks to the LAN ports is done during the initial installation of Linux or subsequently via YaST.

---

### Next steps

Specify UC solution.

## 5.7.3 UC Solution

In the **Change application selection** window, select the UC solution to be used.

You have the following options:

- **Package with UC Smart**  
The UC solution UC Smart is integrated in OpenScape Business S.
- **Package with UC Suite**  
The UC solution UC Suite is integrated in OpenScape Business S.

### 5.7.3.1 How to Define the UC Solution

#### Prerequisites

- You have purchased licenses for either of the UC solutions, UC Smart or UC Suite.
- You are in the **Change application selection** window.

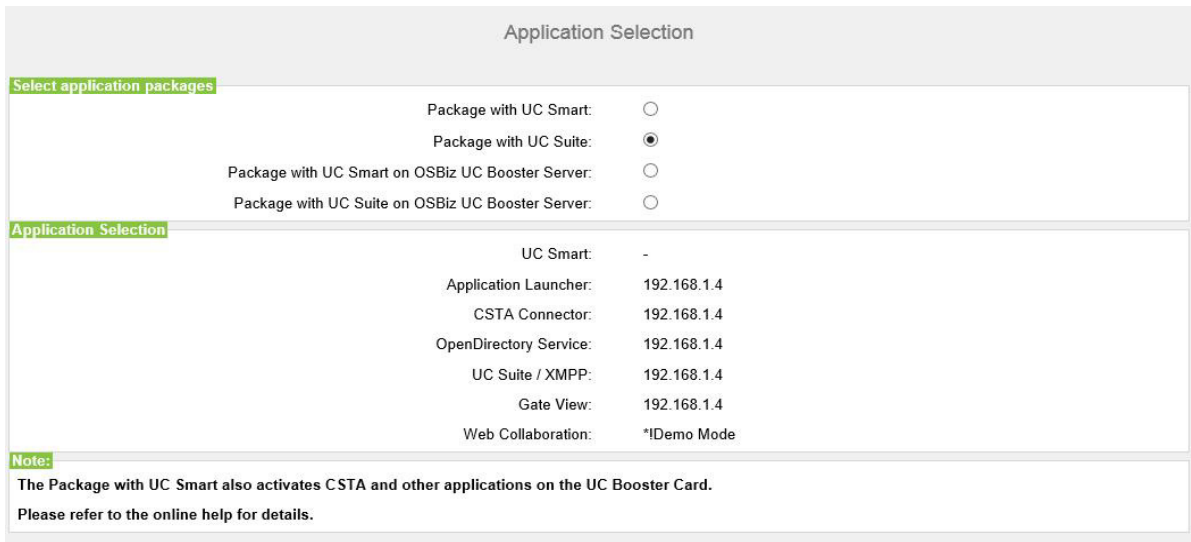

Application Selection	
<b>Select application packages</b>	
Package with UC Smart:	<input type="radio"/>
Package with UC Suite:	<input checked="" type="radio"/>
Package with UC Smart on OSBiz UC Booster Server:	<input type="radio"/>
Package with UC Suite on OSBiz UC Booster Server:	<input type="radio"/>
<b>Application Selection</b>	
UC Smart:	-
Application Launcher:	192.168.1.4
CSTA Connector:	192.168.1.4
OpenDirectory Service:	192.168.1.4
UC Suite / XMPP:	192.168.1.4
Gate View:	192.168.1.4
Web Collaboration:	*IDemo Mode
<b>Note:</b>	
The Package with UC Smart also activates CSTA and other applications on the UC Booster Card. Please refer to the online help for details.	

#### Step by Step

- 1) If you use the UC solution UC Smart, click **Package with UC Smart**.
- 2) If you are using the UC solution UC Suite, click on **Package with UC Suite**.
- 3) Click on **OK & Next**.
- 4) The **Initial installation** wizard is closed. Click on **Finish**.

#### Next steps

Start the basic configuration.

## 5.8 Basic Configuration

The **Basic Installation** wizard is used for basic configuration. Basic configuration includes the most important settings for operating the communication system.

The Basic Installation Wizard includes a progress indicator showing the current step, as well as the steps that follow.

## 5.8.1 How to Start the Basic Installation Wizard

### *Prerequisites*

- The **Initial installation** has been completed.

### *Step by Step*

- 1) In the navigation bar, click on **Setup**.
- 2) Click on **Edit** to start the **Basic Installation** wizard.

### *Next steps*

Perform basic installation as described in the following step-by-step instructions. Fields that are not described here are preset for the default scenario and should only be changed if they are not appropriate for your network data. For detailed information, refer to the descriptions provided in the Administrator documentation for the individual wizards.

## 5.8.2 System Phone Numbers and Networking

Enter the system phone numbers (PABX number, country and area code, international prefix) in the **Overview** window and specify whether OpenScape Business is to be networked with other OpenScape Business systems.

Proceed as follows:

1. Enter system phone numbers
  - Enter system phone numbers for point-to-point connection  
Here you enter the system phone number for your point-to-point connection and the country code and area code.  
The entry of the country code is mandatory for Internet telephony and conference server functionality.  
The international prefix is preset, depending on the previously dialed country code.
  - Enter system phone numbers for point-to-multipoint connection  
Here you enter the country code and area code for your point-to-multipoint connection.  
The entry of the country code is mandatory for Internet telephony and Meet-Me conferences.  
The international prefix is preset, depending on the previously dialed country code.
2. Activate or deactivate networking  
If OpenScape Business is to be networked with other OpenScape Business systems, networking must be enabled, and OpenScape Business must be assigned a node ID. Every OpenScape Business must have a unique node ID in the network.

## 5.8.2.1 How to Enter the System Phone Numbers for a Point-to-Point connection

### Prerequisites

- You have a point-to-point connection.
- You are in the **Summary** window.

Overview

Note: At least the configuration of the 'Country code' is needed for features such as 'Internet telephony' and 'MeetMe conference'.  
If you want your OpenScape Business in "OpenScape Business Network Integration" you should select the "Network Integration" check box and enter a node ID. In this case, make sure that this node ID is unique within the whole network integration.  
Normally, this integration is done by a Service Technician.  
For a standalone OpenScape Business clear the 'Network Integration' check box.

**PABX number**

Country code: 49 (mandatory)  
Local area code: 89 (optional)  
PABX number: 7007 (optional)

**General**

International Prefix: 00

**Network Parameters**

Network Integration:   
Node ID: 0

### Step by Step

- 1) In the **Country Code** field, enter the country code prefix, e.g., 49 for Germany or 1 for the U.S.
- 2) Enter the local area code, e.g., 89 for Munich, in the **Local area code** field.
- 3) Enter the system phone number of your trunk connection, e.g., 7007 (your connection number), in the **PABX number** field.
- 4) Change the **International Prefix** field only if required. The applicable values for Germany and the United States are 00 and 011, respectively.

For international calls, the phone number is preceded by the international prefix and the country code, e.g., "00-1-..." for calls from Germany to the USA and "011-49-..." for calls from the USA to Germany.

### Next steps

Activate or deactivate networking

## 5.8.2.2 How to Enter the System Phone Numbers for a Point-to-Multipoint Connection

### Prerequisites

- You have a point-to-multipoint connection.
- You are in the **Summary** window.



Overview

Note: At least the configuration of the 'Country code' is needed for features such as 'Internet telephony' and 'MeetMe conference'.  
If you want your OpenScape Business in "OpenScape Business Network Integration" you should select the "Network Integration" check box and enter a node ID. In this case, make sure that this node ID is unique within the whole network integration.  
Normally, this integration is done by a Service Technician.  
For a standalone OpenScape Business clear the 'Network Integration' check box.

**PABX number**

Country code: 49 (mandatory)

Local area code: 89 (optional)

PABX number: (optional)

**General**

International Prefix: 00

**Network Parameters**

Network Integration:

Node ID: 0

### Step by Step

- 1) In the **Country Code** field, enter the country code prefix, e.g., 49 for Germany or 1 for the U.S.
- 2) Enter the local area code, e.g., 89 for Munich, in the **Local area code** field.
- 3) Leave the **PABX number** field empty.
- 4) Change the **International Prefix** field only if required. The applicable values for Germany and the United States are 00 and 011, respectively.

For international calls, the phone number is preceded by the international prefix and the country code, e.g., "00-1-..." for calls from Germany to the USA and "011-49-..." for calls from the USA to Germany.

### Next steps

Activate or deactivate networking

## 5.8.2.3 How to Activate or Deactivate Networking

### Prerequisites

- You are in the **Summary** window.

Overview

Note: At least the configuration of the 'Country code' is needed for features such as 'Internet telephony' and 'MeetMe conference'.  
If you want your OpenScape Business in "OpenScape Business Network Integration" you should select the "Network Integration" check box and enter a node ID. In this case, make sure that this node ID is unique within the whole network integration.  
Normally, this integration is done by a Service Technician.  
For a standalone OpenScape Business clear the 'Network Integration' check box.

**PABX number**

Country code: 49 (mandatory)

Local area code: 89 (optional)

PABX number: 7007 (optional)

**General**

International Prefix: 00

**Network Parameters**

Network Integration:

Node ID: 1

### **Step by Step**

- 1) If the communication system is to be networked with other communication systems:
  - a) Select the **Network Integration** check box.
  - b) In the **Node ID** field for the communication system, enter a node ID that is unique in the internetwork (digits from 1 through 100 are possible).
- 2) If the communication system is not to be networked with other communication systems, leave the **Network Integration** check box disabled.

### **Next steps**

Configure the upstream of your Internet connection.

## **5.8.2.4 How to Configure the Upstream of your Internet connection**

### **Prerequisites**

- You are in the **Summary** window.

### **Step by Step**

- 1) In the **Upstream up to (Kbps)** field, enter the speed of your Internet connection.
- 2) Click on **OK & Next**.

### **Next steps**

Configure the station data.

## **5.8.3 Station Data**

If necessary, you can configure your own individual dial plan instead of the predefined default dial plan in the **Central Functions for Stations** window and import additional station data. In an internetwork, the default dial plan must be adapted to the dial plan of the internetwork.

The default dial plan contains predefined numbers for different types of stations (IP phones, analog phones, ...) and for special functions (Internet telephony, voicemail box, AutoAttendant, ...).

The station data includes the internal call numbers, DID numbers and names of the stations. This data and other station data can be imported into the communication system during the basic configuration via an XML file in UTF-8 format.

---

**INFO:** An XML template with the appropriate explanations can be found in the WBM under **Service Center > Documents > CSV**

**Templates.** You can enter your data in this template by using Microsoft Excel, for example.

---

You have the following options:

- **Configure station data without an internetwork**

Proceed as follows:

- a) Display the station data  
You can have all preconfigured station numbers and station data displayed.
- b) Delete all station numbers (optional)  
If you use an individual dial plan, you must delete all preconfigured station numbers.
- c) Adapt preconfigured station numbers for the individual dial plan (optional)  
If you are using an individual dial plan, you can adapt the preconfigured phone numbers to your own dial plan.

---

**INFO:** If the user passes through the **Change preconfigured functional call numbers**, any existing custom configuration done in UC Suite must be reviewed or repeated (e.g., pilot queues)

---

- d) Import station data from an XML file (optional)  
You can easily import your individual station numbers, including any additional station data, during the basic configuration via an XML file.

- **Configure station data with an internetwork**

Proceed as follows:

- a) Delete all station numbers  
If the UC Suite is used in an internetwork, a closed numbering plan is required, i.e., all station numbers in the internetwork must be unique. For this reason, any preconfigured station numbers must be deleted and only stations numbers adapted for the internetwork must be used.
- b) Import station data from an XML file  
The station numbers adapted for the internetwork and any additional station data can be easily imported during the basic configuration via an XML file. This file can contain all stations in the internetwork. During import, only the station numbers and the station data assigned to the previously specified node ID of the communication system will be transferred.

### 5.8.3.1 How to Display the Station Data

#### **Prerequisites**

- You are in the **Central Functions for Stations** window.

**Step by Step**

- 1) Select the **Display stations configuration** radio button.
- 2) Click on **Execute function**. A list of stations with the preconfigured phone numbers (default dial plan) is displayed.
- 3) Click on **OK**. You are taken back to the **Central Functions for Stations** window.
- 4) If you do not want to change any station data, click **OK & Next**.

**5.8.3.2 How to Delete all Call Numbers**

**Prerequisites**

- You are in the **Central Functions for Stations** window.

**Step by Step**

- 1) Enable the radio button **Delete all station call numbers**.
- 2) Enable the check box **Delete All Call Addresses**.
- 3) Click on **Execute function**. All preset call numbers are deleted. The **Change preconfigured call and functional numbers** window then appears.

Change preconfigured call and functional numbers				
• Please keep in mind, that these numbers are not available for station or group dialing use.				
Preconfiguration for Internet Telephony	855	856	857	858
Integrated Voicemail call number (IVM)	350			
Voicemail call number (Smart VM)	351			
Autoattendant call number (Smart VM)	352			
Attendant code	9			
Remote Admin call number	-			
Licensing call number	-			

- 4) Adjust the codes and special call numbers to suit your preferences, and then click **OK**. You are taken back to the **Central Functions for Stations** window.
- 5) If you do not want to change any further station data, click **OK & Next**.

**5.8.3.3 How to Adapt Preconfigured Station Numbers for the Individual Dial Plan**

**Prerequisites**

- You are in the **Central Functions for Stations** window.

### Step by Step

- 1) Enable the radio button **Change pre-configured call and functional numbers**.
- 2) Click on **Execute function**. The **Change preconfigured call and functional numbers** window appears.

Change preconfigured call and functional numbers

• Please keep in mind, that these numbers are not available for station or group dialing use.

Preconfiguration for Internet Telephony	<input type="text" value="855"/>	<input type="text" value="856"/>	<input type="text" value="857"/>	<input type="text" value="858"/>
Integrated Voicemail call number (IVM)	<input type="text" value="350"/>			
Voicemail call number (Smart VM)	<input type="text" value="351"/>			
Autoattendant call number (Smart VM)	<input type="text" value="352"/>			
Attendant code	<input type="text" value="9"/>			
Remote Admin call number	<input type="text" value="-"/>			
Licensing call number	<input type="text" value="-"/>			

- 3) Adjust the preconfigured call numbers to suit your preferences, and then click **OK**. You are taken back to the **Central Functions for Stations** window.
- 4) If you do not want to change any further station data, click **OK & Next**.

## 5.8.3.4 How to Import the Station Data from an XML File

### Prerequisites

- You are in the **Central Functions for Stations** window.
- An XML file with the entered data is available in UTF-8 format. An XML template can be found under **Service Center > Documents > CSV Templates**.

### Step by Step

- 1) Enable the radio button **Import XML file with station data**.
- 2) Click **Execute function**.
- 3) Use **Browse** to select the created XML file and click **Open**.
- 4) Click **OK** when finished. The station data is imported.
- 5) Click **OK & Next**.

## 5.8.4 Internet Telephony

The **Provider configuration and activation for Internet telephony** window is used to configure Internet telephony. You can configure predefined or new Internet Telephony Service Providers (ITSPs). You can configure one or several accounts for each ITSP. Up to 8 ITSPs may be active simultaneously.

You have the following options:

- **Configure a predefined ITSP**  
You can use predefined ITSP templates. To do this, the own access data and phone numbers are entered in the template, and this is then activated.
- **Configure a new ITSP**  
You can also add and activate a new ITSP.  
Configuring a new ITSP is seldom required and can be very time-consuming. This option is therefore not described in the initial installation. Detailed information can be found in the chapter [Configuring an ITSP](#).
- **Disable Internet telephony**  
You can disable Internet telephony.

---

**INFO:** Configuration examples can be found on the Internet at the **Unify Experts Wiki** under *OpenScape Business - SIP / ITSP Connectivity - PDF "OSBiz V2 Configuration for ITSP"*.

---

### Assigning the ITSP Phone Numbers

- In the case of an **Internet Telephony Station Connection**, the ITSP provides individual numbers such as 70005555, 70005556, etc. These individual call numbers are then assigned manually as the internal call numbers of the subscribers.
- In the case of an **Internet telephony point-to-point connection**, the ITSP provides a call number range, e.g., (+49) 89 7007-100 to (+49) 89 7007-147. The call numbers from the range are then assigned manually as the internal call numbers of the subscribers.

These two connection types can be combined as appropriate.

Alternatively, the ITSP phone numbers can be entered as the DID call numbers of the subscriber for both connection types during the station configuration.

Internal call number	Name	DID
100	Andreas Richter	897007100
101	Susanne Mueller	897007101
102	Buddy Miller	897007102
104	Juan Martinez	70005555
105	Emilio Carrara	70005556

The ITSP call numbers thus result from the configured PABX number (e.g., country code 49) and the entered DID numbers in long format. This has advantages for the digit analysis and call management, even in an internetwork. The ITSP connection is thus DID-enabled for another node, for example.

A further CO trunk connection via ISDN is only possible to a limited extent in this case (useful for emergency calls, for example).

## 5.8.4.1 How to Configure a Predefined ITSP

### Prerequisites

- You are in the **Provider configuration and activation for Internet Telephony** window.
- The Internet connection is operational.
- Your ITSP's Internet telephony access data is available (for example, user account, password and Internet telephony numbers).

### Step by Step

- 1) Clear the **No call via Internet** check box. A country-specific list of the possible ITSPs is displayed. The list contains the predefined ITSPs for the selected country and any already created ITSPs.

- 2) If you want to change the preset country, select the desired country from the **Country specific view** drop-down list to display the ITSPs that are available for this country.
- 3) If required, click **Display Status** to check which ITSPs have already been activated and which Internet telephony subscribers have already been configured under each ITSP. You can activate a maximum of 8 ITSPs. Click **OK** when finished.
- 4) To configure Internet telephony stations, click **Edit** in the line associated with the relevant ITSP.
- 5) Activate the check box **Enable Provider**.
- 6) Click **OK & Next**.

- 7) Click **Add** to configure your ITSP accounts with the corresponding Internet telephony numbers. The fields that will then be displayed are provider-specific.

Internet Telephony Station for Sipgate

Internet telephony station: 33455655  
Authorization name: 33455655  
Password: ●●●●●●●●  
Confirm Password: ●●●●●●●●

**Call number assignment**

Use public number (DID)   
Use internal number (Callno) / Single entries   
Use internal number (Callno) / Range entry

Default Number:   
MEX Number:

**Default Number**  
ITSP as primary CO access  
Enter here one of the call numbers supplied by your network provider. This will be used in outgoing calls as calling party number in case that no other number is available for the respective call.  
All call numbers supplied by your network provider are to be entered within the trunk and telephones configuration (DID field) primary CO access.

**MEX Number**  
To use the feature Mobile Extension (MEX) you have to enter a MEX number here. An entered MEX number will only be stored if the ITSP is marked as 'active'.  
For use of MEX it is also necessary to configure a DISA number.

- 8) Enter the credentials for your account in the **Internet Telephony Station** field. You received this data from your ITSP. Depending on the ITSP, different designations are used for this, for example: SIP User, SIP ID, etc.
- 9) Enter the authorization name in the **Authorization name** field. You received this data from your ITSP. If you have not received any authorization name, enter the same data you entered under **Internet Telephony Station**.
- 10) Enter the password you received from the ITSP in the **New Password** and **Confirm Password** fields. Depending on the ITSP, different designations are used for this, for example: Password, SIP Password, etc.
- 11) Assignment of Internet telephony phone numbers - Option 1:  
**Use public number (DID):** the Internet telephony phone numbers of your Internet telephony station connection or Internet telephony point-to-point connection are not entered here during the ITSP configuration, but when the configuring the stations, i.e. the telephones and subscribers (in the **DID** fields).



Internet Telephony Station for Sipgate

Internet telephony station:

Authorization name:

Password:

Confirm Password:

**Call number assignment**

Use public number (DID)

Use internal number (Callno) / Single entries

Use internal number (Callno) / Range entry

Default Number:

MEX Number:

**Default Number**  
ITSP as primary CO access  
Enter here one of the call numbers supplied by your network provider. This will be used in outgoing calls as calling party number in case that no other number is available for the respective call.  
All call numbers supplied by your network provider are to be entered within the trunk and telephones configuration (DID field) primary CO access.

**MEX Number**  
To use the feature Mobile Extension (MEX) you have to enter a MEX number here. An entered MEX number will only be stored if the ITSP is marked as 'active'.  
For use of MEX it is also necessary to configure a DISA number.

- a) Select the option field **Use public number (DID)** in the **Call number assignment** area.
- b) Under **Default Number**, enter the phone number to be used for outgoing calls to subscribers who do not have their own phone number.
- c) If your ITSP supports the "Mobile Extension (MEX)" feature, enter the MEX number provided by the ITSP (8 positions, digits only) under **MEX Number**.

**12) Assignment of Internet telephony phone numbers - Option 2:**

**Use internal number (Callno) / Single entries:** You have an Internet telephony station connection and have received individual call numbers as Internet telephony phone numbers (e.g. 70005555, 70005556,...). Then assign these single numbers to the internal call numbers of the subscribers.

Internet Telephony Station for Sipgate

Internet telephony station:

Authorization name:

Password:

Confirm Password:

**Call number assignment**

Use public number (DID)

Use internal number (Callno) / Single entries

Use internal number (Callno) / Range entry

Internet Telephony Phone Numbers

Add

Enter here all call numbers supplied by your network provider.  
Assignment of call numbers to telephones takes place in a further configuration step.

- a) Select the option field **Use internal number (Callno) / Single entries** in the **Call number assignment** area.

- b) In the **Internet Telephony Phone Numbers** area, enter one of the Internet telephony phone numbers provided by the ITSP in the field next to the **Add** button and then click **Add**.
- c) To assign further Internet telephony numbers to the account, repeat step b).

**13) Assignment of Internet telephony phone numbers - Option 3:**

**Use internal number (Callno) / Range entry:** You have an Internet telephony point-to-point connection and have received a call number range as Internet telephony phone numbers (e.g., +49 89 7007-100 to (+49) 89 7007-147. You then assign the call numbers from the call number range as the internal call numbers of the subscribers.

- a) Select the option field **Use internal number (Callno) / Range entry** in the **Call number assignment** area.
- b) Enter the system phone number under **System phone number (prefix)**.
- c) Enter the desired DID number range for the Internet telephony station in the 'from' and 'to' fields after Direct inward dialing band. The range entered by default is 100 - 147.

**14) Click on OK & Next.**

**15) If you want to configure additional accounts and their associated Internet telephony numbers, repeat steps 7 through 14.**

**16) Click OK & Next.** You will see an overview of which Internet telephony phone numbers are assigned to accounts.

**17) Assign one internal station number each to every Internet telephony phone number.**

This step is not required if you have selected option 1 for the assignment of the Internet telephony phone numbers. In this case, the assignment is made when the configuring the stations (i.e., the telephones and subscribers) in the **DID** field.

Call Number Assignment for Sipgate			
So that an internal participant or members of a call group can telephone via Internet without an "Internet Telephony Phone Number", the "Internet Telephony Phone Number" must be configured with Use as PABX number for outgoing calls.			
Name of Internet Telephony Station	Internet Telephony Phone Number	Internal Call Number	Use as PABX number for outgoing calls
3455655	49897007100	100 Andreas Richter	<input checked="" type="radio"/>
3455655	49897007101	101 Susanne Mueller	<input type="radio"/>
3455655	49897007102	102 Buddy Miller	<input type="radio"/>
3455655	49897007103	103 Janet Jones	<input type="radio"/>
3455655	49897007110	110 Natalie Dubois	<input type="radio"/>
3455655	49897007111	111 Pierre Martin	<input type="radio"/>
3455655	49897007112	112 Claudia Ferraro	<input type="radio"/>
3455655	49897007113	113 Giovanni Rossi	<input type="radio"/>
3455655	49897007114	114 Carlos Alvarez	<input type="radio"/>
3455655	49897007115	115 Emilia Gonzales	<input type="radio"/>
3455655	49897007120	120 Isabel Ferreira	<input type="radio"/>
3455655	49897007121	121 Paolo DaSilva	<input type="radio"/>
3455655	49897007122	122 Ivan VanDenBerg	<input type="radio"/>
3455655	49897007123	123 Robert DeJong	<input type="radio"/>

- a) To do this, select an internal call number in the appropriate line from the **Internal Call Number** drop-down list.
- b) If subscribers without Internet telephony phone numbers or members of a call group are to be allowed to make external calls via the Internet, the radio button **Use as PABX number for outgoing calls** must be activated. The radio button can be activated for only one single Internet telephony phone number.

**18) Click OK & Next.** Here you see again the list of predefined and newly added ITSPs. The enabled ITSPs are identified with a check mark in the **Enable Provider** column. If you are having connection problems with already activated ITSP, you can register it again with **Restart ITSP**.

**19) Click OK & Next.**

**20) Enter the upload speed of your Internet connection in the Upstream up to (Kbps) field.** Please do not confuse this with the download speed!

---

**INFO:** The number of simultaneous Internet calls permitted is displayed in the **Number of Simultaneous Internet calls** field. If the voice quality deteriorates due to the network load, you will need to reduce the number.

---

**21) Click OK & Next.**

**22) If you did not activate the full-time circuit when setting up your Internet access, you can now do this here.** Without a permanent connection (full-time circuit), you cannot receive calls over the Internet. If the full-time circuit has already been set up, the fields described under a) to c) will not appear.

- a) Enable the radio button **On** under **Full-Time Circuit**.
- b) In the **Forced Disconnect at (hour:min)** field, enter the time at which the Internet connection is to be deactivated (e.g., 04:59).
- c) Click **OK & Next**.

**23) Enter the special numbers you want in the Dialed digits column.**

## Initial Setup for OpenScape Business S

### Basic Configuration

Special phone numbers		
Special phone number	Dialed digits	Dial over Provider
1	0C112	ISDN
2	0C110	ISDN
3	0C0137Z	ISDN
4	0C0138Z	ISDN
5	0C0900Z	ISDN
6	0C118Z	ISDN
7	0C116116	ISDN
8		ISDN
9		ISDN
10		ISDN
11		ISDN
12		ISDN
13		ISDN
14		ISDN
15		ISDN

The following station number entries are valid:

0 to 9: allowed digits

-: Field separator

X: Any digit from 0 to 9

N: Any digit from 2 to 9

Z: One or more digits to follow up to the end of dialing

C: Simulated dial tone (can be entered up to three times)













**24)** Use the **Dial over Provider** column to specify whether the special number should be dialed via ISDN or an ITSP. Only the active ITSP is displayed.

---

**INFO:** Ensure that emergency numbers can always be dialed. If you want to dial emergency numbers via an Internet Telephony Service Provider, you must make sure that the ITSP supports this feature.

---

**25)** Click **OK & Next**. The status of your ITSP will be displayed.

Status for the Internet Telephony Service Provider (ITSP)				
Provider		User		
	1&1	Disabled		
	Arcor	Disabled		
	COLT UK & Europe	Disabled		
	COLT VPN	Disabled		
	Ennit AG	Disabled		
	GMX	Disabled		
	PurTel	Disabled		
	QSC	Disabled		
	Sipgate	Enabled	33455655	registered
	Sipgate Trunking	Disabled		
	Skype Connect	Disabled		
	toplink	Disabled		
	Vodafone Anlagenanschluss	Disabled		

The configured ITSPs at which you are already registered are marked in green.

The configured ITSPs at which you are not yet registered are marked in orange.

26) Click **Next** followed by **Finish**.

## 5.8.4.2 How to Deactivate Internet Telephony

### Prerequisites

- You are in the **Provider configuration and activation for Internet Telephony** window.

### Step by Step

- 1) Leave the **No call via Internet** check box selected.
- 2) Click **OK & Next** twice.

## 5.8.5 Stations

In the **Select a station - ...** window, you can configure the stations connected to the communication system.

Proceed as follows:

1. Configure the IP and SIP stations  
IP and SIP stations include LAN phones or WLAN phones, for example.

### 5.8.5.1 How to Configure IP and SIP Stations

#### Prerequisites

- You are in the **Select a station - LAN Phones** window.
- A functional wireless LAN network is needed to operate WLAN phones.

Select a station -LAN Phones

Take DID from changed call number

Box Slot	Callno	Name	DID	Type	Fax Callno	Fax DID	Class of service	Call pickup
1 0	110	Natalie Dubois	110	System Client	-	-	International	-
1 0	111	Pierre Martin	111	System Client	-	-	International	-
1 0	112	Claudia Ferraro	112	System Client	-	-	International	-
1 0	113	Giovanni Rossi	113	System Client	-	-	International	-
1 0	114	Carlos Alvarez	114	System Client	-	-	International	-
1 0	115	Emilia Gonzales	115	System Client	-	-	International	-
1 0	120	Isabel Ferreira	120	SIP Client	-	-	International	-
1 0	121	Paolo DaSilva	121	SIP Client	-	-	International	-
1 0	122	Ivan VanDenBerg	122	SIP Client	-	-	International	-
1 0	123	Robert DeJong	123	SIP Client	-	-	International	-

#### Step by Step

- 1) If you want a different direct inward dialing number for the station than the call number, enter a DID number for the station under **DID** in the row of the desired station:
  - Only for a point-to-point connection:  
Click in the desired field and type in the DID number using the keyboard. The DID number may also be identical to the internal station number.
  - Only for a point-to-multipoint connection:  
Select an MSN in the desired field via the drop-down list. The station can be internally reached via the internal station number 101, for example, and externally via the MSN 654321.
  - For point-to-point and point-to-multipoint connections:  
Select the entry **xxx - modifiable** (xxx is the internal station number) via the drop-down list in the desired field and type in the DID number using the keyboard or select an MSN from the drop-down list.
- 2) Enter the internal station number for the subscriber under **Call No** in the appropriate row of the desired subscriber. You can use the preset phone number or assign some other free number.
- 3) In the row of the desired station, under **Name**, enter a name in the format Last Name, First Name.

---

**INFO:** The name can consist of up to 16 characters, but should not include any diacritical characters such as umlauts or special characters. The name specified here will be entered as the Last Name at the UC clients, but can be edited there.

---

- 4) Select the type of IP station (e.g., "System Client" or "SIP Client") from the **Type** drop-down list in the row of the desired station.
- 5) If you want to set up a fax box for the subscriber (which can be used with the UC clients **myPortal for Desktop** or **myPortal for Outlook**, for example), proceed as follows:
  - a) In the row of the desired station, in the **Fax No.** field, enter the desired internal fax number at which the user can receive internal fax messages.
  - b) If you want to configure a DID number for the fax box, enter the desired external fax number under which the subscriber can receive external fax messages in the **Fax Direct Inward Dialing** field in the row of the desired subscriber.
- 6) Choose the desired Class of Service group in the row of the desired subscriber from the **Class of Service** drop-down list.
- 7) To add the subscriber to a call pickup group, select a call pickup group from the **Call pickup group** drop-down list in the row of the desired subscriber.
- 8) Make the settings described under this step only if needed or for a SIP phone:
  - a) Click in the row of the desired station on the pencil icon **Edit**.

Change Station	
Station	Fax
Name: (for Subscriber):	Paolo DaSilva
Call number:	121
Direct inward dialing: (Number for Direct Inward Dialing)	121
<b>Mobility</b>	
Mobile Call number:	0016012345678
Web Feature ID:	(SIP Client) 121
<b>direct inward dialing for Internet Telephony</b>	
Sipgate:	4989565656111
<b>Parameter</b>	
Type:	SIP Client
Device Type:	SIP Extension
Clip/Lin:	
Language:	German
Call signaling internal: (Ringer pitch for internal calls):	Ring type 1
Call signaling external: (Ringer pitch for external calls):	Ring type 1
<b>Security</b>	
Authentication active:	<input checked="" type="checkbox"/>
Password:	••••••
Confirm password:	••••••
SIP User ID / Username:	SIP-121
Realm:	SOBIZ-SIP

- b) For SIP phones: If the SIP phone is to be operated in conjunction with a dual-mode mobile phone, enter the dialout prefix followed by the telephone number of the mobile phone (e.g., 0016012345678) in the Mobility area under Mobile phone number. In addition, select this SIP client from the Web Feature ID drop-down list. (see [Dual-Mode Telephony](#)).

- c) In the **Clip/Lin** field, enter a phone number (DID number or MSN) to be displayed at the called party's extension instead of the own phone number in the case of an external call.

---

**INFO:** This feature must be released by the network provider.

---

- d) Select the language for the menu controls on the phone from the **Language** drop-down list.
  - e) From the **Call signaling internal** drop-down list, select and assign one of a total of eight possible acoustic call signals for internal calls. The station then will then send the modified ringing tone to other internal stations, thus enabling its calls to be distinguished from other internal stations (default: Ring type 1).
  - f) From the **Call signaling external** drop-down list, select and assign one of a total of three possible acoustic call signals for external calls (default: Ring type 1).
  - g) Only for SIP phones: Enable the **Authentication active** check box.
  - h) Only for SIP phones: Enter the authentication password in the **Password** and **Confirm password** fields.
  - i) Only for SIP phones: Enter the user ID for the authentication in the **SIP User ID / Username** field.
  - j) Only for SIP phones: Enter the associated zone for the authentication in the **Realm** field.
  - k) Click on **OK & Next**.
  - l) Change the station flags as needed. For a description of the station flags, see [Station > Station > Station Parameters](#).
  - m) Click on **OK & Next**.
- 9) If you want to configure another IP station, click on **Store data** and repeat steps 1 through 8.
  - 10) Click on **OK & Next**. A list of all configured stations appears. This list is effectively a dial plan.
  - 11) If required, click **Print** to print out the data of the configured stations.
  - 12) Then click **OK & Next**.

## 5.8.6 Configuring UC Suite

You can perform the automatic configuration of the UC solution UC Suite in the **Automatic Configuration of the Application Suite** window.



---

**INFO:** This window appears only if **Package with UC Suite** was selected during the application selection in the **Initial Installation** wizard.

---

### 5.8.6.1 How to Configure the UC Suite

#### Prerequisites

- You are in the **Automatic Configuration of Application Suite** window.

Automatic Configuration of Application Suite

Sip Interconnection 1: -  
Sip Interconnection 2: -

Application Suite is not configured.

Please press 'Ok & Next' for skipping this page or press 'Execute function' to proceed with the automatic Application Suite configuration.

Note that by pressing 'Execute function' Sip Interconnection 1 will be overwritten and assigned to Application Suite profile.

Clear SIP Interconnection 1:  
 Add 46 trunks to SIP Interconnection 1:  
 Application Suite Configuration:  
 Smart VM deactivation:

#### Step by Step

- › Click on **Execute function**. The UC Suite is configured automatically. Once the progress bar shows 100%, click on **OK & Next**.

### 5.8.7 Configuring UC Smart Mailboxes

If you are using the UC solution UC Smart, you can perform the automatic configuration of the UC Smart voicemail boxes (Smart VM, Smart VoiceMail) in the **Automatic Configuration of Smart VM** window.

---

**INFO:** This window appears only if **Package with UC Smart** was selected during the application selection in the **Initial Installation** wizard.

---

#### 5.8.7.1 How to Configure UC Smart Voicemail Boxes

#### Prerequisites

- You are in the **Automatic Configuration of Smart VM** window.

## Initial Setup for OpenScape Business S Basic Configuration

Automatic Configuration of Smart VM

- The automatic Smart VM configuration is an initial configuration. There will be voicemailboxes assigned to the first 100 stations in system. If there are already existing voicemail or autoattendant mailboxes, then all mailbox data will be deleted irrevocably!
- Press "Ok & Next" for skipping this page or press "Execute function" to proceed with Smart VM configuration.

Total Progress

Functionality

### Step by Step

- 1) If the UC Smart voicemail boxes are not to be used, click on **OK & Next**. The configuration of the voicemail boxes will be skipped.
- 2) If the UC Smart voicemail boxes are to be used, click on **Execute function**. Voicemail boxes are then automatically configured for the first 100 subscribers. Once the progress bar shows 100%, click on **OK & Next**.

---

**INFO:** Existing UC Smart or UC Smart AutoAttendant voicemail boxes are irrevocably deleted in the process.

---

## 5.8.8 Conference Server Settings

The **MeetMe Conference** settings window can be used to define the call numbers and the dial-in numbers for conferences.

### 5.8.8.1 How to Edit the Conference Server Settings

#### Prerequisites

- You are in the **Configure MeetMe Conference** window.

Configure MeetMe Conference

Call number: 444

Direct inward dialing: 445

(Number for Direct Inward Dialing)

### Step by Step

- 1) Enter a phone number for the conference in the **Phone Number** field.
- 2) Enter the dial-in number for the conference (conference DID) with which subscribers can dial into an existing conference in the **Direct inward dialing** field.
- 3) Click on **OK & Next**.

## 5.8.9 E-mail Delivery (Optional)

You can configure the delivery of e-mails in the **Configure E-Mail Forwarding** window. These e-mails notify users of voicemail and fax messages and administrators of system messages.

You have the following options:

- **Configuring the Sending of E-mails**  
You can specify an external E-mail server via which the e-mails are to be sent by OpenScape Business. Voicemails, fax messages and internal system messages can then be sent via this E-mail server to one or several different configurable e-mail addresses.

---

**INFO:** Entering the e-mail server is important if an e-mail with a link to the installation file(s) is to be automatically sent to the users of the UC Suite.

---

### 5.8.9.1 How to Configure the Sending of E-mails

#### Prerequisites

- An e-mail account with a password exists with an e-mail provider, and you know the access data for this account.
- You are in the **Configure E-Mail Forwarding** window.

The screenshot shows a configuration window with three sections:

- Server Information:** Includes fields for "Outgoing Mail Server (SMTP)" (smtp.web.de), "Outgoing mail server port" (1234), and a checkbox for "This server requires an encrypted connection (TLS/SSL)".
- Logon Information:** Includes fields for "User Name" (max.mustermann.de), "Password" (masked with dots), and "Confirm Password" (masked with dots).
- User Information (Sender):** Includes a field for "E-Mail Address" (max.mustermann@web.de).

#### Step by Step

- 1) Enter the **Outgoing mail server (SMTP)** for the e-mail server to be used for sending e-mails, e.g., `smtp.web.de`. Ask your e-mail provider for the outgoing mail server if required.

---

**INFO:** Make sure that the name of the outgoing mail server can be resolved. If not, you must start the e-mail sending function via

**Service Center > E-mail Forwarding** and then enter the IP address of the outgoing mail server instead of its name.

---

- 2) If a secure connection is required, enable the corresponding check box. If required, check with your e-mail provider whether this option needs to be enabled.
- 3) Enter the **User Name** of the e-mail account, e.g.,: `john.doe`.
- 4) Enter the **Password** for the e-mail account and repeat it in the **Confirm Password** field.
- 5) Enter the **E-mail Address**, for example: `john.doe@web.de`.
- 6) If you want to test the entered e-mail settings immediately, proceed as follows:
  - a) Click on **Test Connection**.
  - b) Under **Send to e-mail address**, enter the e-mail address of any e-mail box that you can access. The test e-mail will be sent to that e-mail address.
  - c) Under **Subject in the e-mail**, enter a descriptive text so that you can identify the e-mail in your e-mail inbox.
  - d) Click on **Send Test E-mail**. The e-mail settings are verified, and the e-mail is sent to the specified e-mail address.
  - e) Check whether the e-mail has arrived in your e-mail inbox.
  - f) If the e-mail was sent correctly, proceed to the next step.
  - g) If the e-mail delivery failed, click **Back** and correct your e-mail settings.
- 7) Enter the **E-mail Address 1** to get a notification email when ALI tolerance has been used. You may also enter a second email address.
- 8) Click on **OK & Next** followed by **Finish**. The basic installation is finished. Before you perform the backup mentioned in the wizard, you should activate the licenses.

## 5.9 Closing Activities

After the initial installation and the basic installation with the WBM have been completed, some important settings must still be made for the operation of OpenScape Business.

Proceed as follows:

1. Activate and assign licenses  
The licenses procured with OpenScape Business must be activated within a period of 30 days. The time period begins the next time you log on to the WBM. After this time period expires, the communication system will only operate in restricted mode. Once the licenses have been activated successfully, they must be assigned to the stations and lines. System-wide features are enabled automatically upon activation.

2. Provision the UC Smart client for installation (only for UC Smart)  
The UC Smart client myPortal Smart is a part of UC Smart. The installation file for myPortal Smart is accessible via the WBM and can be made available to the IP stations automatically or manually. For more information, see [UC Smart Clients](#).
3. Provision the UC Clients for installation  
The UC clients are part of the UC Suite. The installation files for the UC Client are accessible via the WBM and can be made available to the IP stations automatically or manually.  
In addition, the administrator has the option of performing a silent installation. The silent installation/uninstallation is a command-line based method to automatically install, uninstall or modify UC Suite PC clients on a PC without requiring any further user inputs. For more information, see [Silent Installation/Uninstallation for UC Suite PC Clients](#).
4. Perform a data backup  
All previous changes to OpenScape Business must be backed up. The backup can be stored as a backup set in the internal network, for example.

## 5.9.1 How to Activate and Assign the Licenses

### Prerequisites

- You are logged on to the WBM with the **Advanced** profile.
- You know the LAC (License Authorization Code) for releasing the license and have a user ID and password for accessing the license server.
- You need Internet access to connect to the license server.

### Step by Step

- 1) Activate license online:
  - a) In the navigation bar, click on **Setup**.
  - b) In the navigation tree, click **Wizards > Basic Installation**.
  - c) Click on **Edit** to start the **Licensing** wizard.

Activate License Online

Licenses with Locking ID: 00-1a-e8-5d-ea-ff

License Authorization Code (LAC)

I have the user name and password for the License Server and want to log on.

User name

Password

**Note: The response from the License Server can take up to 90 seconds !**

**Initial Setup for OpenScope Business S**  
Closing Activities

- d) Enter the appropriate LAC in the **License Authorization Code (LAC)** field.
  - e) Select the check box **I have the user name and password for the License Server and want to log on.**
  - f) Enter the **User Name** and **Password** for logging into the License Server.
  - g) Click on **OK & Next**. The connection to the license server is established, and the licenses are released.
- 2) Assign licenses to stations:
- a) Click on **License Management** in the navigation bar.
  - b) In the navigation tree, navigate to the desired type of subscriber under **Local User Licenses > ...**. You will be shown a list of all subscribers of the selected subscriber type.
  - c) In the row of the desired subscriber, select the check box in the **User license** column (first column with check boxes).

Access	Call number	Name													
			<b>Remaining licenses</b>												
			5	5	5	0	0	0	0	0	0	0	0	0	0
LAN 0-SYS-9	110	Natalie Dubois	<input checked="" type="checkbox"/>	<input type="checkbox"/>	<input type="checkbox"/>	<input type="checkbox"/>	<input type="checkbox"/>	<input type="checkbox"/>	<input type="checkbox"/>	<input type="checkbox"/>	<input type="checkbox"/>	<input type="checkbox"/>	<input type="checkbox"/>	<input type="checkbox"/>	<input type="checkbox"/>
LAN 0-SYS-5	120	Pierre Martin	<input checked="" type="checkbox"/>	<input type="checkbox"/>	<input type="checkbox"/>	<input type="checkbox"/>	<input type="checkbox"/>	<input type="checkbox"/>	<input type="checkbox"/>	<input type="checkbox"/>	<input type="checkbox"/>	<input type="checkbox"/>	<input type="checkbox"/>	<input type="checkbox"/>	<input type="checkbox"/>
LAN 0-SYS-6	130	Claudia Ferraro	<input type="checkbox"/>	<input type="checkbox"/>	<input type="checkbox"/>	<input type="checkbox"/>	<input type="checkbox"/>	<input type="checkbox"/>	<input type="checkbox"/>	<input type="checkbox"/>	<input type="checkbox"/>	<input type="checkbox"/>	<input type="checkbox"/>	<input type="checkbox"/>	<input type="checkbox"/>
LAN 0-SYS-7	140	Giovanni Rossi	<input type="checkbox"/>	<input type="checkbox"/>	<input type="checkbox"/>	<input type="checkbox"/>	<input type="checkbox"/>	<input type="checkbox"/>	<input type="checkbox"/>	<input type="checkbox"/>	<input type="checkbox"/>	<input type="checkbox"/>	<input type="checkbox"/>	<input type="checkbox"/>	<input type="checkbox"/>
LAN 0-SYS-8	150	Carlos Alvarez	<input type="checkbox"/>	<input type="checkbox"/>	<input type="checkbox"/>	<input type="checkbox"/>	<input type="checkbox"/>	<input type="checkbox"/>	<input type="checkbox"/>	<input type="checkbox"/>	<input type="checkbox"/>	<input type="checkbox"/>	<input type="checkbox"/>	<input type="checkbox"/>	<input type="checkbox"/>
LAN 0-SYS-3	210	Emilia Gonzales	<input checked="" type="checkbox"/>	<input type="checkbox"/>	<input type="checkbox"/>	<input type="checkbox"/>	<input type="checkbox"/>	<input type="checkbox"/>	<input type="checkbox"/>	<input type="checkbox"/>	<input type="checkbox"/>	<input type="checkbox"/>	<input type="checkbox"/>	<input type="checkbox"/>	<input type="checkbox"/>
LAN 0-SIP-5	220	Paolo DaSilva	<input checked="" type="checkbox"/>	<input type="checkbox"/>	<input type="checkbox"/>	<input type="checkbox"/>	<input type="checkbox"/>	<input type="checkbox"/>	<input type="checkbox"/>	<input type="checkbox"/>	<input type="checkbox"/>	<input type="checkbox"/>	<input type="checkbox"/>	<input type="checkbox"/>	<input type="checkbox"/>
LAN 0-SIP-6	230	Ivan Vandenberg	<input checked="" type="checkbox"/>	<input type="checkbox"/>	<input type="checkbox"/>	<input type="checkbox"/>	<input type="checkbox"/>	<input type="checkbox"/>	<input type="checkbox"/>	<input type="checkbox"/>	<input type="checkbox"/>	<input type="checkbox"/>	<input type="checkbox"/>	<input type="checkbox"/>	<input type="checkbox"/>
LAN 0-SYS-4	240	Robert DeJoung	<input checked="" type="checkbox"/>	<input type="checkbox"/>	<input type="checkbox"/>	<input type="checkbox"/>	<input type="checkbox"/>	<input type="checkbox"/>	<input type="checkbox"/>	<input type="checkbox"/>	<input type="checkbox"/>	<input type="checkbox"/>	<input type="checkbox"/>	<input type="checkbox"/>	<input type="checkbox"/>
LAN 0-SYS-1			<input type="checkbox"/>	<input type="checkbox"/>	<input type="checkbox"/>	<input type="checkbox"/>	<input type="checkbox"/>	<input type="checkbox"/>	<input type="checkbox"/>	<input type="checkbox"/>	<input type="checkbox"/>	<input type="checkbox"/>	<input type="checkbox"/>	<input type="checkbox"/>	<input type="checkbox"/>
LAN 0-SIP-3			<input type="checkbox"/>	<input type="checkbox"/>	<input type="checkbox"/>	<input type="checkbox"/>	<input type="checkbox"/>	<input type="checkbox"/>	<input type="checkbox"/>	<input type="checkbox"/>	<input type="checkbox"/>	<input type="checkbox"/>	<input type="checkbox"/>	<input type="checkbox"/>	<input type="checkbox"/>
LAN 0-SIP-4			<input type="checkbox"/>	<input type="checkbox"/>	<input type="checkbox"/>	<input type="checkbox"/>	<input type="checkbox"/>	<input type="checkbox"/>	<input type="checkbox"/>	<input type="checkbox"/>	<input type="checkbox"/>	<input type="checkbox"/>	<input type="checkbox"/>	<input type="checkbox"/>	<input type="checkbox"/>
LAN 0-SYS-2			<input type="checkbox"/>	<input type="checkbox"/>	<input type="checkbox"/>	<input type="checkbox"/>	<input type="checkbox"/>	<input type="checkbox"/>	<input type="checkbox"/>	<input type="checkbox"/>	<input type="checkbox"/>	<input type="checkbox"/>	<input type="checkbox"/>	<input type="checkbox"/>	<input type="checkbox"/>

- d) Activate the user-oriented licenses in the row of the desired subscriber by selecting the appropriate check boxes.

Access	Call number	Name													
			<b>Remaining licenses</b>												
			5	5	5	0	0	0	0	0	0	0	0	0	0
LAN 0-SYS-9	110	Natalie Dubois	<input checked="" type="checkbox"/>	<input checked="" type="checkbox"/>	<input checked="" type="checkbox"/>	<input type="checkbox"/>	<input type="checkbox"/>	<input type="checkbox"/>	<input type="checkbox"/>	<input type="checkbox"/>	<input type="checkbox"/>	<input type="checkbox"/>	<input type="checkbox"/>	<input type="checkbox"/>	<input type="checkbox"/>
LAN 0-SYS-5	120	Pierre Martin	<input checked="" type="checkbox"/>	<input checked="" type="checkbox"/>	<input checked="" type="checkbox"/>	<input type="checkbox"/>	<input type="checkbox"/>	<input type="checkbox"/>	<input type="checkbox"/>	<input type="checkbox"/>	<input type="checkbox"/>	<input type="checkbox"/>	<input type="checkbox"/>	<input type="checkbox"/>	<input type="checkbox"/>
LAN 0-SYS-6	130	Claudia Ferraro	<input type="checkbox"/>	<input type="checkbox"/>	<input type="checkbox"/>	<input type="checkbox"/>	<input type="checkbox"/>	<input type="checkbox"/>	<input type="checkbox"/>	<input type="checkbox"/>	<input type="checkbox"/>	<input type="checkbox"/>	<input type="checkbox"/>	<input type="checkbox"/>	<input type="checkbox"/>
LAN 0-SYS-7	140	Giovanni Rossi	<input type="checkbox"/>	<input type="checkbox"/>	<input type="checkbox"/>	<input type="checkbox"/>	<input type="checkbox"/>	<input type="checkbox"/>	<input type="checkbox"/>	<input type="checkbox"/>	<input type="checkbox"/>	<input type="checkbox"/>	<input type="checkbox"/>	<input type="checkbox"/>	<input type="checkbox"/>
LAN 0-SYS-8	150	Carlos Alvarez	<input type="checkbox"/>	<input type="checkbox"/>	<input type="checkbox"/>	<input type="checkbox"/>	<input type="checkbox"/>	<input type="checkbox"/>	<input type="checkbox"/>	<input type="checkbox"/>	<input type="checkbox"/>	<input type="checkbox"/>	<input type="checkbox"/>	<input type="checkbox"/>	<input type="checkbox"/>
LAN 0-SYS-3	210	Emilia Gonzales	<input checked="" type="checkbox"/>	<input checked="" type="checkbox"/>	<input checked="" type="checkbox"/>	<input type="checkbox"/>	<input type="checkbox"/>	<input type="checkbox"/>	<input type="checkbox"/>	<input type="checkbox"/>	<input type="checkbox"/>	<input type="checkbox"/>	<input type="checkbox"/>	<input type="checkbox"/>	<input type="checkbox"/>
LAN 0-SIP-5	220	Paolo DaSilva	<input checked="" type="checkbox"/>	<input checked="" type="checkbox"/>	<input type="checkbox"/>	<input type="checkbox"/>	<input type="checkbox"/>	<input type="checkbox"/>	<input type="checkbox"/>	<input type="checkbox"/>	<input type="checkbox"/>	<input type="checkbox"/>	<input type="checkbox"/>	<input type="checkbox"/>	<input type="checkbox"/>
LAN 0-SIP-6	230	Ivan Vandenberg	<input checked="" type="checkbox"/>	<input checked="" type="checkbox"/>	<input type="checkbox"/>	<input type="checkbox"/>	<input type="checkbox"/>	<input type="checkbox"/>	<input type="checkbox"/>	<input type="checkbox"/>	<input type="checkbox"/>	<input type="checkbox"/>	<input type="checkbox"/>	<input type="checkbox"/>	<input type="checkbox"/>
LAN 0-SYS-4	240	Robert DeJoung	<input checked="" type="checkbox"/>	<input checked="" type="checkbox"/>	<input type="checkbox"/>	<input type="checkbox"/>	<input type="checkbox"/>	<input type="checkbox"/>	<input type="checkbox"/>	<input type="checkbox"/>	<input type="checkbox"/>	<input type="checkbox"/>	<input type="checkbox"/>	<input type="checkbox"/>	<input type="checkbox"/>
LAN 0-SYS-1			<input type="checkbox"/>	<input type="checkbox"/>	<input type="checkbox"/>	<input type="checkbox"/>	<input type="checkbox"/>	<input type="checkbox"/>	<input type="checkbox"/>	<input type="checkbox"/>	<input type="checkbox"/>	<input type="checkbox"/>	<input type="checkbox"/>	<input type="checkbox"/>	<input type="checkbox"/>
LAN 0-SIP-3			<input type="checkbox"/>	<input type="checkbox"/>	<input type="checkbox"/>	<input type="checkbox"/>	<input type="checkbox"/>	<input type="checkbox"/>	<input type="checkbox"/>	<input type="checkbox"/>	<input type="checkbox"/>	<input type="checkbox"/>	<input type="checkbox"/>	<input type="checkbox"/>	<input type="checkbox"/>
LAN 0-SIP-4			<input type="checkbox"/>	<input type="checkbox"/>	<input type="checkbox"/>	<input type="checkbox"/>	<input type="checkbox"/>	<input type="checkbox"/>	<input type="checkbox"/>	<input type="checkbox"/>	<input type="checkbox"/>	<input type="checkbox"/>	<input type="checkbox"/>	<input type="checkbox"/>	<input type="checkbox"/>
LAN 0-SYS-2			<input type="checkbox"/>	<input type="checkbox"/>	<input type="checkbox"/>	<input type="checkbox"/>	<input type="checkbox"/>	<input type="checkbox"/>	<input type="checkbox"/>	<input type="checkbox"/>	<input type="checkbox"/>	<input type="checkbox"/>	<input type="checkbox"/>	<input type="checkbox"/>	<input type="checkbox"/>

**INFO:** User-oriented licenses can be assigned to a subscriber only if a station license (user license) was assigned to the subscriber earlier (step c).

- e) Click on **OK & Next**. A check is performed to determine whether there are enough licenses for your assignment.  
If sufficient licenses are available, the licensing of the subscriber is completed.
  - f) If licenses are missing, the errors are indicated by displaying a check box shaded in red. Correct these errors and repeat step e.
- 3) Assign licenses to trunks:
- a) In the navigation tree, click **CO trunks**. The number of trunk licenses purchased will be displayed in the **CO trunks** area.
  - b) For SIP trunks: In the **License demand for number of simultaneous Internet calls in this node** area, enter the number of Internet calls that can be conducted simultaneously via an ITSP.
  - c) Click on **OK & Next**.

## 5.9.2 How to Provision the UC Smart Client for Installation

### *Prerequisites*

- You are logged on to the WBM with the **Advanced** profile.
- The hardware and software for using UC Smart are available.

---

**INFO:** Licenses are required to use the UC Smart client myPortal Smart.

---

### *Step by Step*

- 1) Click on **Service Center** in the navigation bar.
- 2) Click on **Software** in the navigation tree.
- 3) Click on the Download icon of **myPortal Smart** and save the installation file on a shared network drive.
- 4) Click on the link icon for **Adobe AIR** and download the installation file to a shared network drive.
- 5) Send the two installation files to the users of myPortal Smart.
- 6) Alternatively, you can also send the users of myPortal Smart two links with which they can access the installation files:

```
https://<IP address of the communication system>/  
management/downloads/SmartClient.air
```

```
http://www.adobe.com/air
```

## 5.9.3 How to Provision the UC Suite Clients for Installation

### Prerequisites

- You are logged on to the WBM with the **Advanced** profile.
- The hardware and software for using the UC Suite are available.

---

**INFO:** Licenses are required to use the UC Suite clients.

---

### Step by Step

- 1) To enable the installation files to be provided automatically to a station, make sure that the following steps have been performed:
  - a) The e-mail addresses of the stations and the associated subscriber data must have either been already imported via an XML file or entered later under **Setup > UC Suite > User Directory**.
  - b) An e-mail server must have been specified.

---

**INFO:** You can also enter an E-mail server later under **Service Center > E-mail Forwarding**.

---

All subscribers whose e-mail addresses are known receive an e-mail with a link to the installation directory of the UC clients and Getting Started Instructions. The installation folder also includes a Readme file with information on installing the software on client PCs.

- 2) If the required steps for automatic notification are not fulfilled, you can also make the installation files available manually. To do this, proceed as follows:
  - a) Click on **Service Center** in the navigation bar.
  - b) Click on **Software** in the navigation tree.
  - c) Click on the desired UC client and save the zipped installation file on a shared network drive.
  - d) Click in the navigation tree on **Documents** and select **User Guide** from the drop-down list.
  - e) Click on the documentation of the desired UC client and save the documentation file on a shared network drive.
  - f) Send the zipped installation file and the documentation file to the users of the UC clients by e-mail or inform the users about the storage location of these files.
  - g) The zip file with the installation files also includes a Readme file. Notify the users that the installation of the UC clients must be performed in accordance with the installation notes in the Readme file.



- 3) Alternatively, you can also send the UC users links through which they can directly access the installation files of the UC clients.
  - a) Click on **Service Center** in the navigation bar.
  - b) Click on **Software** in the navigation tree.
  - c) Click on the **Show Application Links** button. You will be presented with multiple links, depending on the used operating system and the desired UC client. For example:

```
https://<IP address of the communication system>/  
management/downloads/install-common.zip
```

## 5.9.4 How to Perform a Data Backup

### Prerequisites

- You are logged on to the WBM with the **Advanced** profile.

---

**INFO:** For more information on backing up data, see [Immediate Backup](#).

---

### Step by Step

- 1) Click on **Backup and Restore** in the navigation bar.
- 2) In the navigation tree, click **Backup - Immediate**.
- 3) Enter a comment for the backup set in the **Comment** field in the **Name** area so that the backup set can be easily identified if needed later for a restore. Avoid the use of diacritical characters such as umlauts and special characters in your input.
- 4) Activate the target drive on which the backup set is to be saved (e.g., a network drive) in the **Devices** area.
- 5) Click on **OK & Next**. The progress of the backup process is displayed in a separate window.
- 6) The backup was successful if the message **Backup completed successfully!** appears. Click on **Finish**.
- 7) This completes the initial startup with WBM. Exit the WBM by right-clicking the **Logout** link on the top right of the screen and then close the window.

## 5.10 Commissioning of IP Phones

The commissioning of IP phones can be facilitated by the existence of a DHCP server that supplies an IP phone with important (network-specific) data that is needed to log into the communication system.

### **Network-Specific Data**

In order to log into the communication system, an IP phone requires some network-specific data. This data can be stored in the DHCP server or be entered directly at the IP phone. The advantage of a DHCP server is that all connected IP phones are automatically supplied with the relevant data.

The following data is required by the IP phone:

- IP address of the communication system
- IP address of DLS server

In addition, the IP phone needs its own call number. This must be entered manually when logging in at the phone.

### **Registration of SIP Phones**

For security reasons, it is recommended that SIP phones register at the communication system. To do this, the registration information on the IP phone and the communication system must match.

The following data is required for the login:

- SIP user ID
- SIP password
- SIP realm (optional)

Use a non-trivial SIP password that complies with the following rules:

- At least 8 characters
- At least one uppercase letter (A - Z)
- At least one lowercase letter (a - z)
- At least one digit (0-9)
- At least one special character

Use a SIP user ID that does not include the phone number.

---

**INFO:** More information on configuring SIP telephones can be found at [http://wiki.unify.com/wiki/SIP\\_devices\\_configuration\\_examples](http://wiki.unify.com/wiki/SIP_devices_configuration_examples).

---

### **Using the Internal DHCP Server**

If the internal DHCP server of the communication system is used, the network-specific data will already be stored there. In order to enable an IP phone to register at the communication system, only the specified call number must be entered at the IP phone. In the case of SIP phones, the SIP registration data at the SIP phone and at the communication system must match.

### **Using an External DHCP Server with Network-specific Data**

If an external DHCP server is used, the network-specific data must be stored there. In order to enable an IP phone to register at the communication system, only the specified call number must be entered at the IP phone. In the case of SIP

phones, the SIP registration data at the SIP phone and at the communication system must match.

### Using an External DHCP Server without Network-specific Data

If an external DHCP server in which the network-specific data cannot be stored is used, this must be entered at the IP phone. To enable an IP phone to register at the communication system, the defined call number and IP address of the communication system must be entered at the phone, and the settings for the Deployment Service may need to be changed. In the case of SIP phones, the SIP registration data at the SIP phone and at the communication system must match.

## 5.10.1 How to Configure an IP Phone

### Prerequisites

- The IP phone is connected to the internal network and operational.

---

**INFO:** The sample configuration described here uses an OpenStage 40/60/80 IP system telephone. The same settings must also be made for any other IP phone. For more information, refer to the manual supplied with your IP phone.

---

### Step by Step

- 1) To reach the administration mode of the IP system telephone, press the appropriate key for the Settings/Applications menu on the phone.
- 2) Scroll through the `Settings` options until `Admin` and confirm this with the OK key.
- 3) Enter administrator password (123456 by default) and confirm your selection with the OK key.
- 4) If you are using the DHCP server of the communication system in the internal network, skip the next step.
- 5) If you are not using the DHCP server of the communication system in the internal network, you will need to enter the IP addresses of the Deployment Server (DLS) and the communication system so that the software of the IP system telephone can be updated automatically. This applies only to IP system telephones. Proceed as follows:
  - a) Scroll to `Network` and confirm your selection with the OK key.
  - b) Scroll to `Update service (DLS)` and confirm your selection with the OK key.
  - c) Scroll to `DLS address` and confirm your selection with the OK key.
  - d) Specify the IP address of the communication system (192.168.1.2 by default) as the Deployment Server and confirm your entry with the OK key.

- e) Scroll to `Save & Exit` and confirm your selection with the OK key.
  - f) Scroll to `IPv4 configuration` and confirm your selection with the OK key.
  - g) Scroll to `Route (default)` and confirm your selection with the OK key.
  - h) Specify the IP address of the communication system ( `192.168.1.2` by default) and confirm your entry with the OK key.
  - i) Scroll to `Save & Exit` and confirm your selection with the OK key.
  - j) Navigate one menu level back with the Back key.
- 6) Specify the call number of the phone:
- a) Scroll to `System` and confirm your selection with the OK key.
  - b) Scroll to `Identity` and confirm your selection with the OK key.
  - c) Scroll to `Terminal number` and confirm your selection with the OK key.
  - d) Enter the set phone number (e.g., `120`) and confirm your selection with the OK key.
  - e) Scroll to `Save & Exit` and confirm your selection with the OK key.
- 7) Navigate one menu level back with the Back key.
- 8) If the system telephone needs to be restarted due to the changes made, the menu item `Restart` will appear in the `Admin` menu. Confirm the `Restart` with the OK key and then also confirm `Yes` with the OK key. The system telephone performs a reboot and logs in to the communication system.

## 5.10.2 How to Configure a SIP Phone

### *Prerequisites*

- The SIP phone is connected to the customer LAN and operational.

---

**INFO:** The configuration described here uses an OpenStage 40/60/80 SIP system telephone as an example. The same settings must also be made for another SIP phone. For more information, refer to the manual supplied with your SIP phone.

---

### *Step by Step*

- 1) To reach the administration mode of the SIP system telephone, press the appropriate key for the `Settings/Applications` menu on the phone.
- 2) Scroll through the `Settings` options until `Administrator (Admin)` and confirm this with the OK key.
- 3) Enter administrator password (`123456` by default) and confirm your selection with the OK key.

- 4) If you are using the DHCP server of the communication system in the internal network, skip the next step.
- 5) If you are not using the DHCP server of the communication system in the internal network, you will need to enter the IP addresses of the Deployment Server (DLS) and the communication system so that the software of the SIP system telephone can be updated automatically. This applies only to SIP system telephones. Proceed as follows:
  - a) Scroll to `Network` and confirm your selection with the OK key.
  - b) Scroll to `Update service (DLS)` and confirm your selection with the OK key.
  - c) Scroll to `DLS address` and confirm your selection with the OK key.
  - d) Specify the IP address of the communication system (`192.168.1.2` by default) as the Deployment Server and confirm your entry with the OK key.
  - e) Scroll to `Save & Exit` and confirm your selection with the OK key.
  - f) Scroll to `IPv4 configuration` and confirm your selection with the OK key.
  - g) Scroll to `Route (default)` and confirm your selection with the OK key.
  - h) Specify the IP address of the communication system (`192.168.1.2` by default) and confirm your entry with the OK key.
  - i) Scroll to `Save & Exit` and confirm your selection with the OK key.
  - j) Navigate one menu level back with the Back key.
- 6) Specify the SNTP time settings:
  - a) Scroll to `Date and time` and confirm your selection with the OK key.
  - b) Scroll to `Time source` and confirm your selection with the OK key.
  - c) Scroll to `SNTP IP address` and confirm your selection with the OK key.
  - d) Specify the IP address of the communication system (`192.168.1.2` by default) and confirm your entry with the OK key.
  - e) Scroll to `Timezone offset` and confirm your selection with the OK key.
  - f) Enter the deviation between the local time and UTC (Universal Time Coordinated) in hours (Germany: 1) and confirm this with the OK button.
  - g) Scroll to `Save & Exit` and confirm your selection with the OK key.
  - h) Navigate one menu level back with the Back key.
- 7) Specify the call number of the phone:
  - a) Scroll to `System` and confirm your selection with the OK key.
  - b) Scroll to `Identity` and confirm your selection with the OK key.
  - c) Scroll to `Terminal number` and confirm your selection with the OK key.
  - d) Enter the set phone number (e.g., 120) and confirm your selection with the OK key.

- e) Scroll to `Save & Exit` and confirm your selection with the OK key.
- 8) Specify the SIP authentication data:
  - a) Scroll to `Registration` and confirm your selection with the OK key.
  - b) Scroll to `SIP Session` and confirm your selection with the OK key.
  - c) Note the `Realm`, or enter a new realm (e.g., `OSBIZ-SIP`), if necessary.
  - d) Note the `User ID`, or enter a new user ID (e.g., `SIP-120`), if necessary.
  - e) Specify a `Password` for registering at the SIP server.
  - f) Scroll to `Save & Exit` and confirm your selection with the OK key.
- 9) Use the Back key to go back to the `Admin` menu.
- 10) If the system telephone needs to be restarted due to the changes made, the menu item `Restart` will appear in the `Admin` menu. Confirm the `Restart` with the OK key and then also confirm `Yes` with the OK key. The system telephone performs a reboot and logs in to the communication system.

## 5.11 Uninstalling the Communication Software

The software communication can be uninstalled via a text console.

### 5.11.1 How to Uninstall the Communication Software

#### *Step by Step*

- 1) Open a terminal (e.g., a GNOME terminal).
- 2) Enter the command `su` (for superuser = root) in the shell interface and confirm it by pressing the Enter key.
- 3) Enter the password for the "root" user in the shell interface and confirm it by pressing the Enter key.
- 4) Enter the command `oso_deinstall.sh` in the shell interface and confirm it by pressing the Enter key. Follow the instructions of the uninstallation program.

## 5.12 Used Ports

The OpenScape Business system components use different ports, which may need to be opened in the firewall as required. For the ports of the web-based clients (e.g., myPortal to go), port forwarding must be configured in the router.

**INFO:** The ports identified with "O" in the list below are optional, i.e., are not permanently open in the firewall (e.g., the TFTP port is open only when Gate View is activated).

Description	TCP	UDP	Port number	OpenScape Business X	UC Booster Card	OpenScape Business S	UC Booster Server
<b>System components</b>							
Admin Portal (https)	X		443	X	X	X	X
CAR Update Registration	X		12061	X		X	
CAR Update Server	X		12063	X		X	
CLA	X		61740	O		O	O
CLA Auto Discovery		X	23232	X		X	X
Csta Message Dispatcher (CMD)	X		8900		X	X	X
CSTA Protocol Handler (CPH)	X		7004	X		X	
Csta Service Provider (CSP)	X		8800		X	X	X
DHCP		X	67	X			
DLI	X		18443	X		X	X
DLSC	X		8084	X		X	X
DNS	X	X	53	X			
FTP	X		21	O		O	
FTP Passive	X		40000:40040	O		O	
Gate View	X		8000:8010		O	O	O
HFA	X		4060	X		X	
HFA Secure	X		4061	X		X	
JSFT	X		8771		X	X	X
JSFT	X		8772		X	X	X
LAS Cloud Service	X		8602	X			
LDAP server	X		389		X	X	X
Manager E	X		7000	X			
MEB SIP	X		15060		X		X
NAT traversal (NAT-T)		X	4500	X			
NTP		X	123	X			
Openfire Admin (https)	X		9091		X	X	X
OpenScape Business Multisite	X		8778		X	X	X

**Initial Setup for OpenScape Business S**  
Used Ports

Description	TCP	UDP	Port number	OpenScape Business X	UC Booster Card	OpenScape Business S	UC Booster Server
OpenScape Business myReports (http)	X		8101		X	X	X
OpenScape Business status server	X		8808	X		X	X
OpenScape Business user portal	X	X	8779		X	X	X
Postgres	X		5432	X	X	X	X
RTP (embedded)		X	29100:30530	X	X	X	X
RTP (server)		X	29100:30888	X	X	X	X
SIP (server)	X	X	5060	X		X	
SIP TLS SIPQ (server)	X		5061	X		X	
SIP TLS Subscriber (server)	X		5062	X		X	
SNMP (Get/Set)		X	161	X		X	
SNMP (traps)		X	162	X		X	
TFTP		X	69		O	O	O
VSL	X		8770		X	X	X
Webadmin for Clients	X		8803	X	X	X	X
XMPP Connection Manager	X		5262		X	X	X
XMPP server	X		5269		X	X	X
<b>Web-based clients</b>							
Web-based clients (http)	X		8801	X	X	X	X
Web-based clients (https)	X		8802	X	X	X	X

---

**INFO:** For security reasons, we recommend that only https be used for the web-based clients and that port forwarding be set up from external TCP/443 to internal TCP/8802.

---



## 6 Initial Setup of OpenScape Business UC Booster

This section describes the initial installation and configuration of the OpenScape Business UC Booster at the OpenScape Business X3/X5/X8 communication system. Note that a distinction is made here, depending on whether the OpenScape Business UC Booster Card or the OpenScape Business UC Booster Server is to be used for the UC Booster functionality.

The initial setup of the OpenScape Business UC Booster is carried out using the OpenScape Business Assistant administration program (web-based management, also called WBM in short).

The detailed administration of any features that are not covered by the initial setup is described in subsequent chapters.

### Initial Setup of the OpenScape Business UC Booster Card

The OpenScape Business UC Booster Card is installed in the OpenScape Business X3/X5/X8 communication system and configured for operation. This is followed by the configuration of the OpenScape Business UC Booster functionality.

The specific installation steps required for the initial setup differ, depending on whether the UC Booster Card is being put into operation with the OpenScape Business X3/X5/X8 communication system for the first time or whether it is being integrated later in an existing and already configured OpenScape Business X3/X5/X8 communication system.

Overview of the installation steps for both options:

Integration in a New Communication System	Integration in an Existing Communication System
	<a href="#"><i>Backing up the Configuration Data of the Communication System</i></a>
<p>Installing the UC Booster Card</p> <p>The UC Booster Card is installed in the OpenScape Business X3/X5/X8 communication system.</p> <p>For a description, see the OpenScape Business Service Documentation, Hardware Installation - Description of the Boards.</p>	<p>Installing the UC Booster Card</p> <p>The UC Booster Card is installed in the OpenScape Business X3/X5/X8 communication system.</p> <p>For a description, see the OpenScape Business Service Documentation, Hardware Installation - Description of the Boards.</p>

**Initial Setup of OpenScape Business UC Booster**  
Used Ports

Integration in a New Communication System	Integration in an Existing Communication System
<p>Configuring the UC Booster Card</p> <p>The configuration of the UC Booster Card is performed together with the initial installation of the OpenScape Business X3/X5/X8 communication system.</p> <p>For a description, see the <a href="#">Integration into the Customer LAN</a>.</p>	<p>Configuring the UC Booster Card</p> <p>The configuration of the UC Booster Card is performed later on an already configured OpenScape Business X3/X5/X8 communication system.</p> <p>For a description, see the <a href="#">Integration into the Customer LAN</a>.</p> <p>For the specifics of the configuration, see <a href="#">Configuring the UC Booster Card</a></p>
<p>Basic Configuration</p> <p>The basic configuration is performed together with the initial installation of the OpenScape Business X3/X5/X8 communication system.</p> <p>For a description, see the <a href="#">Basic Configuration</a>.</p>	<p>Basic Configuration</p> <p>The basic configuration is performed later on an already configured OpenScape Business X3/X5/X8 communication system.</p> <p>For a description, see the <a href="#">Basic Configuration</a>.</p> <p>For the special features of the basic configuration, see <a href="#">Basic Configuration</a></p>
<p>Closing Activities</p> <p>The closing activities (including the licensing of the UC Clients) are performed together with the initial installation of the OpenScape Business X3/X5/X8 communication system.</p> <p>For a description, see the <a href="#">Closing Activities</a>.</p>	<p>Closing Activities</p> <p>The closing activities (including the licensing of the UC Clients) are performed together with the initial installation of the OpenScape Business X3/X5/X8 communication system.</p> <p>For a description, see the <a href="#">Closing Activities</a>.</p> <p>For the special features of the closing activities, see <a href="#">Closing Activities</a></p>

**Initial Installation of the OpenScape Business UC Booster Server**

The OpenScape Business UC Booster Server is integrated together with the OpenScape Business X3/X5/X8 communication system in the customer LAN.

The OpenScape Business communication software for the OpenScape Business UC Booster Server, which provides the OpenScape Business UC Booster functionality, is installed on the Linux operating system SLES 11 SP4 64 bit. The communication software can be operated directly on a Linux server or in a virtual environment with VMware vSphere. The installation of the Linux operating system is described in the installation guide *OpenScape Business, Installing the Linux Server*.

The OpenScape Business UC Booster Server has its own WBM. This WBM is used for software updates, backing up the configuration data and diagnostics of the OpenScape Business UC Booster Server. The initial installation of the OpenScape Business UC Booster server is performed with the WBM of the communication system.

The specific installation steps required for the initial installation differ, depending on whether the UC Booster Server is being put into operation with the OpenScape Business X3/X5/X8 communication system for the first time or whether it is being connected later to an existing and already configured OpenScape Business X3/X5/X8 communication system.

Overview of the installation steps for both options:

Integration in a New Communication System	Integration in an Existing Communication System
	Backing up the Configuration Data of the Communication System
Installing the Linux Server The installation of the Linux server is described in the OpenScape Business Linux Server Installation Guide.	Installing the Linux Server The installation of the Linux server is described in the OpenScape Business Linux Server Installation Guide.
<a href="#">Installing the Communication Software</a>	<a href="#">Installing the Communication Software</a>
<a href="#">Function Check with the OpenScape Observer</a>	<a href="#">Function Check with the OpenScape Observer</a>
Configuring the UC Booster Server The configuration of the UC Booster Server is performed together with the initial installation of the OpenScape Business X3/X5/X8 communication system. For a description, see the <a href="#">Integration into the Customer LAN</a> .	Configuring the UC Booster Server The configuration of the UC Booster Server is performed later on an already configured OpenScape Business X3/X5/X8 communication system. For a description, see the <a href="#">Integration into the Customer LAN</a> . For the specifics of the configuration, see <a href="#">Configuring the UC Booster Server</a>
Basic Configuration The basic configuration is performed together with the initial installation of the OpenScape Business X3/X5/X8 communication system. For a description, see the <a href="#">Basic Configuration</a> .	Basic Configuration The basic configuration is performed later on an already configured OpenScape Business X3/X5/X8 communication system. For a description, see the <a href="#">Basic Configuration</a> . For the special features of the basic configuration, see <a href="#">Basic Configuration</a>
Closing Activities The closing activities (including the licensing of the UC Clients) are performed together with the initial installation of the OpenScape Business X3/X5/X8 communication system. For a description, see the <a href="#">Closing Activities</a> .	Closing Activities The closing activities (including the licensing of the UC Clients) are performed together with the initial installation of the OpenScape Business X3/X5/X8 communication system. For a description, see the <a href="#">Closing Activities</a> . For the special features of the closing activities, see <a href="#">Closing Activities</a>

## 6.1 Prerequisites for the Initial Setup

Meeting the requirements for the initial setup ensures the proper operation of the OpenScape Business UC Booster.

### General

Depending on the used hardware (phones, ...) and the existing infrastructure, the following general conditions apply:

- The OpenScape Business X3/X5/X8 communication system is configured and ready for use.
- The LAN infrastructure (Internet routers, switches, etc.) is present and usable.

## Initial Setup of OpenScape Business UC Booster

### Prerequisites for the Initial Setup

- The IP phones are connected to the customer LAN.
- A broadband Internet connection is recommended for software updates and remote access.
- All licenses required for the OpenScape Business UC Booster are present (e.g., UC clients, Gate View, Directory Services, etc.). When integrating in an already licensed communication system, there is no activation period.
- An IP address scheme exists and is known.
- A dial plan (also called a numbering plan) is present and known.

### For UC Booster Card

The following requirements must be observed for the operation of the UC Booster Card.

- OpenScape Business Hardware:  
The UC Booster Card is installed.
- Switch:  
The switch through which the UC Booster Card is connected with the communication system should be IPv6-enabled for the UC Booster Card to receive an IP address during the initial setup.  
If the switch is not IPv6-enabled, the red LED of the communication system flashes. In this case, the Admin port of the system must be connected to the second LAN port of the UC Booster Card using an additional Ethernet cable. This causes the UC Booster Card to automatically receive an IPv4 IP address via the IPv6 protocol. As soon as the UC Booster Card is reachable over IP, the red LED of the communication system goes out. The desired IP address for the UC Booster Card can then be entered during the initial setup. Communication between the system and UC Booster Card now takes place through the IPv4 connection of the switch.

---

**INFO:** The additional Ethernet cable should be left connected in case a restart or a reload is required.

---

- Fan kit:  
The UC Booster Card requires an additional fan. The fan kit depends on the communication system.
- Housing cover:  
For the OpenScape Business X3W, a new housing cover is required for the UC Booster Card fan kit.  
When migrating from HiPath 3000 systems, new housing covers to accommodate the UC Booster Card fan kit are required for OpenScape Business X3W/X5W and X3R/X5R.
- Communication software:  
The software of the communication system must be upgraded to the latest released software version. Note that the image including the UC Booster Card software must be used for this purpose.
- Web browsers:  
The Admin PC is used for the initial setup of the UC Booster Card with the OpenScape Business Assistant (WBM). The WBM is browser-based and is

thus independent of the operating system. A screen resolution of 1024 x 768 or higher is required.

The following HTML 5-enabled web browsers are supported:

- Microsoft Internet Explorer Version 10 and later.
- Mozilla Firefox Version 17 and later
- Google Chrome

If an older version of the web browser is installed, you will need to install an up-to-date version before you can start the initial setup of the system.

---

**INFO:** Unrestricted network access is needed between OSCC and OCAB.

---

### **For UC server Booster**

The following requirements must be observed for the operation of the UC Booster Server.

- **Linux server:**  
The Linux server required for OpenScape Business S was installed as per the instructions in the *OpenScape Business Linux Server Installation Guide*, was integrated into the customer LAN, and is ready for use.
- **OpenScape Business communication software:**  
The installation DVD with the OpenScape Business communication software is available. After the software installation, the software of the communication system and communication software of the UC Booster Server must be updated separately to the same, latest released software version.
- **DVD with Linux operating system SLES 11 SP4 64 bit**  
The Linux DVD may be needed during the installation of the OpenScape Business communication software, since some software packages (RPM) required for the communication software may need to be installed later from this DVD.
- **Web browsers:**  
For the initial setup of the UC Booster Server with the OpenScape Business Assistant (WBM), either the Linux server or the Admin PC can be used. The WBM is browser-based and is thus independent of the operating system. A screen resolution of 1024 x 768 or higher is required.  
The following HTML 5-enabled web browsers are supported:
  - Microsoft Internet Explorer Version 10 and later (Admin PC).
  - Mozilla Firefox Version 17 and later (Linux server / Admin PC)
  - Google ChromeIf an older version of the web browser is installed, you will need to install an up-to-date version before you can start the initial setup of the system.
- **Firewall:**  
When connected to the Internet, a firewall is needed for the Linux server to prevent unauthorized access from outside. After installing Linux, the Linux firewall is enabled. The installer of the communication software adjusts the firewall settings so that the communication software can be operated properly.

## Initial Setup of OpenScape Business UC Booster

### Backing up the Configuration Data of the Communication System

The ports for the communication software are opened, and all other ports are closed.

If an external firewall is used in the network, the Linux firewall must be disabled, and the addresses and ports required for the communication software must be opened (see [Used Ports](#)).

## 6.2 Backing up the Configuration Data of the Communication System

Before installing the OpenScape Business UC Booster, the existing configuration data of the OpenScape Business communication system must always be saved by creating a backup.

The backup is performed at the WBM of the OpenScape Business communication system.

It can be stored on different backup media (such as a USB drive or a network drive).

### 6.2.1 How to Perform a Data Backup

#### *Prerequisites*

- You are logged in at the WBM of the communication system with the **Advanced** profile.
- For a data backup on a USB device, the USB device must be connected to the USB server interface of the communication system.

#### *Step by Step*

- 1) Click on **Backup and Restore** in the navigation bar.
- 2) In the navigation tree, click **Backup - Immediate**.
- 3) Enter a comment for the backup set in the **Comment** field in the **Name** area so that the backup set can be easily identified if needed later for a restore. Avoid the use of diacritical characters such as umlauts and special characters in your input.
- 4) Activate the target drive on which the backup set is to be saved in the **Devices** area.
- 5) Click on **OK & Next**. The progress of the backup process is displayed in a separate window.
- 6) The backup was successful if the message **Backup completed successfully!** appears. Click on **Finish**.
- 7) If you are using a USB stick as the backup medium, wait until the LED of the USB stick stops blinking. This ensures that the backup has been successfully saved on the USB stick. You can then safely remove the USB stick.
- 8) This completes the backup with the WBM. Exit the WBM by right-clicking the **Logout** link on the top right of the screen and then close the window.

## 6.3 Commissioning the UC Booster Card

The commissioning of the UC Booster Card includes the installation in the OpenScape Business communication system and the initial configuration for proper operation.

After completing the configuration successfully, a software update must be performed.

### 6.3.1 Installing the UC Booster Card

The UC Booster Card is integrated into the OpenScape Business communication system. The slot used for the UC Booster Card depends on the communication system.

The installation of the UC Booster Card is described in detail in the service documentation Hardware Installation under the section "Description of the Boards".

The UC Booster Card can be integrated into the following OpenScape Business communication systems:

- OpenScape Business X3R and X5R (OCCMR)  
UC Booster Card with additional fan kit.
- OpenScape Business X3W and X5W (OCCM)  
UC Booster Card with additional fan kit.  
For the OpenScape Business X3W, a new housing cover for the fan kit is also required.
- OpenScape Business X8 (OCCL)  
UC Booster Card with additional fan kit.

### 6.3.2 Configuring the UC Booster Card

During the configuration, the basic settings for the operation of UC Booster Card are set up.

The configuration of the UC Booster Card is performed with the **Initial Installation** wizard in the WBM of the communication system. The description of the configuration can be found in the section Initial installation of OpenScape Business X3/X5/X8.

The **Initial Installation** wizard of the WBM includes the initial configuration of the entire communication system. The following configuration components are important for the operation of the OpenScape Business UC Booster Card:

- IP address of the UC Booster Card  
The UC Booster Card requires a separate IP address from the network segment of the communication system.

- Selection of the UC solution  
You can select whether the UC solution UC Smart or UC Suite is to be used.

Changing the IP address of the UC Booster Card or UC solution leads to a restart of the communication system.

### 6.3.3 Updating the Software for the UC Booster Card

In order to enable the UC Booster Card to operate correctly, the software of the communication system needs to be updated. All missing software components for the UC Booster Card will then be installed.

If the software of the communication system is already up-to-date, the system must be updated again with the latest software to ensure that all components required for the UC Booster Card functionality are now installed.

The software update can be optionally performed via the Internet or via an image file, which can be obtained from the Software Download Server. When performing the update via the image file, make sure that the image file containing the UC Booster Card portions (osbiz...\_ocab.tar) is used.

#### 6.3.3.1 How to Perform a Software Update

##### *Prerequisites*

- Access to the Internet is available.
- You are logged on to the WBM with the **Advanced** profile.

##### *Step by Step*

- 1) Click on **Service Center** in the navigation bar.
- 2) In the navigation tree, click on **Software Update > Update via Internet**. The currently installed software version is displayed to you.
- 3) Click on **OK & Next**.
- 4) Read the license agreement (EULA) fully and then enable the radio button **I accept the license agreement**.
- 5) Click on **OK & Next**.
- 6) Select the radio button **Start Action - Immediately / Immediately after transfer**.
- 7) Click on **OK & Next**. The software update is loaded into the communication system in the background and automatically activated after the transmission. After two restarts, the software is up-to-date.

---

**INFO:** You can close the browser window at any time.

---



- 8) You can check the current status of the update with the WBM under **Service Center > Software Update > Status**.

## 6.4 Commissioning the UC Booster Server

The commissioning of the the UC Booster Server includes the installation of the OpenScape Business communication software on the Linux server and the initial configuration for proper operation.

After completing the configuration successfully, a software update must be performed.

### 6.4.1 Installing the Communication Software

The OpenScape Business communication software is installed on the Linux server using the OpenScape Business DVD.

Make sure that the IP addresses and network masks to be configured are appropriate for the customer LAN.

#### DHCP Server

A DHCP server automatically assigns a unique IP address to each IP station (IP phones, PCs, etc.) and provides the IP stations with network-specific data such as the IP address of the default gateway, for example.

Either an external DHCP server (e.g., the DHCP server of the Internet router or of the communication system) or the DHCP server of the Linux server can be used as a DHCP server. If the DHCP server of the Linux server is used, the external DHCP server must be disabled. The configuration of the Linux DHCP server can be performed during the installation of the OpenScape Business communication software.

#### Virtual Environment

The communication software can run in a virtual environment. To do this, the virtualization software (host operating system) must be first installed and configured on the server PC. Linux is then installed as a guest operating system. Within the Linux operating system, the communication software is installed last (see the *OpenScape Business Linux Server Installation Guide* for more details).

Use of snapshots on virtual machines (VM):

Snapshots can be a valuable maintenance mechanism, for example, to perform a fast rollback to a predefined operating state of the VM after a mass distribution script has failed.

- Snapshots cannot be created during normal operation. While a snapshot is being taken, the current operating state of the virtual machine is frozen. Consequently, connected devices and applications such as IP phones or the UC clients can lose the connection to the server.

- Snapshots can cause internal server processes to lose their synchronization, which means that the stable operation of the communication system can then no longer be guaranteed. A server reboot following the snapshot should therefore also be planned within the maintenance timeframe.
- Previous snapshots should not remain on the production environment during normal operation.
- Snapshots can be taken during a planned maintenance window or within the framework of the installation.
- Snapshots are used internally by backup tools such as VDP or VDR. It must be ensured that these backup operations are scheduled outside of business hours and that the snapshots generated by these tools are deleted at the end of the operation.

More information regarding snapshots can be found in the VMware knowledge base (KB). A good starting point is the KB article 1025279 – Best Practices for virtual machine snapshots in the VMware environment (<http://kb.vmware.com/kb/1025279>).

### 6.4.1.1 How to Install the Communication Software

#### *Prerequisites*

- The SLES 11 SP4 64 bit operating system has been correctly installed and started on the Linux server.
- DVD or .ISO file with OpenScape Business communication software.
- DVD or .ISO file with the Linux operating system SLES 11 SP4 64 bit for any subsequent installation of software packages (RPM) that may be required.
- The root access data (user name and password) for logging into the Linux server is available.

---

**IMPORTANT:** The OpenScape Business communication software overwrites any existing configuration files (e.g., for DHCP, FTP, Postfix, etc.) during the installation.

---

#### *Step by Step*

- 1) Log into the Linux server with root privileges.
- 2) Insert the OpenScape Business DVD or .ISO file into the DVD drive.
- 3) Confirm the message with **Run**. The "Welcome" window appears.
- 4) Select the desired setup language (e.g., **English**) and click **Start**. The rest of the installation is described here for the English language.
- 5) Select the desired product from the list and click on **Select**. A check is performed to determine whether the hardware meets all the requirements for the installation. A warning is displayed for minor shortfalls in meeting the requirements. After confirmation, the installation can then be continued. For severe shortfalls, the installation is canceled automatically.

- 6) A check is performed to determine whether additional RPM packages need to be installed. If yes, confirm this with **Confirm**. If this occurs, you will need to switch back to the SLES 11 DVD or .ISO file later.
- 7) A window with the terms of the license (i.e., the End User License Agreement or EULA) appears. Read the terms of the license and accept the license agreement with **Yes**.
- 8) If a DHCP server is already present in the customer LAN (e.g., the DHCP server of the Internet router), stop the configuration of the Linux DHCP server here with **No** and proceed to step 12 to continue.

---

**INFO:** In order to ensure that the software of system telephones can be updated automatically even when using an external DHCP server, you have two options:

a) The IP address of the Linux server must be entered as the DLS address at each system telephone.

b) The network-specific data must be entered at the external DHCP server. The parameters for this can be found under `/var/log/OPTI.txt`.

---

- 9) If you want to use the Linux DHCP server, click on **Yes** to enable and configure the Linux DHCP server.
- 10) Enter the following values (preset with default values):
  - **Default Route:** IP address of the default gateway; as a rule, the IP address for the Internet router, e.g., 192.168.5.1.
  - **Domain** (optional): the domain specified during the Linux installation, e.g., <customer>.com
  - **DNS-Server** (optional): IP address of the DNS server specified during the Linux installation. If no DNS server is available in the internal network, you can enter the IP address of the Internet router (e.g., 192.168.5.1) here.
  - **SNTP Server:** IP address of the internal or external NTP server.
  - **DLS/DLI Server:** IP address of DLS server, i.e., the IP address of the Linux server (e.g.: 192.168.5.10).
  - **Subnet:** appropriate subnet for the IP address range, e.g.: 192.168.5.0.
  - **Netmask:** Subnet mask of the Linux server that was specified during the Linux installation, e.g.: 255.255.255.0.
  - **IP range begin** and **IP range end:** IP address range from which the DHCP server may assign IP addresses, e.g.: 192.168.5.100 to 192.168.5.254.
- 11) Click on **Continue**.
- 12) After the installation, the Linux operating system needs to be restarted. Select the check box **PC Reboot** and confirm with **Continue**.

- 13) If additional RPM packages need to be installed, you will be prompted to insert the SLES 11 DVD or .ISO file. Insert the DVD or .ISO file and confirm with **Continue**. Following the successful installation of the RPM packages, reinsert the OpenScape Business DVD or .ISO file and confirm this with **Continue**, followed by **Run**.
- 14) The OpenScape Business communication software is installed. The operating system then automatically performs a restart.
- 15) After the restart, log in with the user account that was set up earlier during the Linux installation.
- 16) Right-click on the DVD drive icon on the desktop and select the menu item **Eject**. Remove the OpenScape Business DVD from the DVD drive.

---

**INFO:** It takes a few minutes until all components of the OpenScape Business communication software are active. Using the OpenScape Observer, you can check when the OpenScape Business communication software is ready for use.

---

## 6.4.2 Function Check with the OpenScape Observer

The OpenScape Observer program can be used to check whether OpenScape Business is operational.

OpenScape Observer can be started from the Admin PC or from a client PC in the internal network. To do this, the program must be copied from the Service Center of the WBM to the PC.

### 6.4.2.1 How to Copy OpenScape Observer to the PC

#### **Prerequisites**

- The OpenScape Business communication software is installed.
- The latest Oracle Java version is installed on the PC.

#### **Step by Step**

- 1) Start the web browser on the PC and open the login page of the WBM at the following address:

`https://<IP address of the Linux server>, e.g., https://192.168.5.10.`

- 2) If the browser reports a problem with a security certificate, install the certificate (using the example of Internet Explorer V10).

- a) Close the web browser.

- b) Open the web browser with administrator rights by clicking the right mouse button on the web browser icon and selecting the menu item **Run as administrator** from the context menu.
- c) Allow the User Account Control.
- d) Open the login page of the WBM at the following address:  

```
https://<IP address of the Linux server>, e.g., https://  
192.168.5.10.
```
- e) Click on **Continue to this website**.
- f) Click on the message **Certificate Error** in the navigation bar of the web browser.
- g) Click on **View Certificates**.
- h) Click on **Install Certificate** (only visible with administrator rights).
- i) Select the option **Local Computer** and confirm with **Next**.
- j) Select the option **Place all certificates in the following store**, click **Browse** and specify **Trusted Root Certification Authorities**.
- k) Confirm with **OK** and then with **Next** and **Finish**.
- l) Confirm the certificate import with **OK** and close the certificate window **OK**.
- m) Close the web browser.
- n) Start the web browser again (without administrator rights) and open the login page of the WBM at the following address:  

```
https://<IP address of the Linux server>, e.g., https://  
192.168.5.10.
```
- 3) Click on the language code at the top right and select the language in which the user interface of the WBM is to be displayed from the menu. The Login page will be displayed in the selected language.
- 4) In the field under **Login**, enter the default user name `administrator@system` for access as an administrator.

---

**INFO:** If you press the tab key after entering `administrator`, `@system` will be added automatically.

---

- 5) In the second field under **Login**, enter the default password `administrator` for access as an administrator.
- 6) Click **Login**.
- 7) You are prompted to change the default password.
  - a) Reenter the default password **administrator** in the `Password` field.
  - b) Enter a new password in the **New Password** and **Confirm New Password** fields to protect the system against misuse. Note case usage and the status of the **Num** key. The password is displayed as a string of asterisks (\*).

---

**INFO:** The password must be at least 8 characters long and include a digit. Make sure that you remember your new password.

---

- 8) Click **Login**.
- 9) Click **Service Center** on the navigation bar.
- 10) Click in the **Software** area on the item **OpenScape Observer**.
- 11) Save the file `OsoObserver.jar` on the PC in a directory of your choice.

### 6.4.2.2 How to Start OpenScape Observer from the PC

#### *Prerequisites*

- The file `OsoObserver.jar` is stored on the client PC.

#### *Step by Step*

- 1) Navigate on the PC to the storage path of OpenScape Observer.
- 2) Double-click on the file `OsoObserver.jar`. OpenScape Observer opens as a small window in the upper left corner of the screen.
- 3) Enter the IP address of the Linux server on which the OpenScape Business communication software is installed (e.g., `192.168.5.10`) in the field of the OpenScape Observer.
- 4) Click on **Connect OSO**.
- 5) Another window opens with the following contents:
  - IP address of the Linux server (in the header)
  - Version number of the installed OpenScape Business communication software
  - Version of the Linux server operating system
  - Utilization of the home partition (HD) and memory (RAM) of the Linux server as a percentage
  - Abbreviation of the installed product (e.g., `S` for OpenScape Business `S` and `B` for the UC Booster Server)
- 6) In the window you will also be informed about the status of OpenScape Business with an LED display:
  - Red LED: The OpenScape Business system components cannot be started - OpenScape Business is not ready for use
  - Yellow LED: The OpenScape Business system components have started - OpenScape Business is not yet ready for use
  - Green LED: The OpenScape Business system components have started - OpenScape Business is ready for use

## 6.4.3 Configuring the UC Booster Server

During the initial configuration, the basic settings for the operation of the UC Booster Server are defined.

The configuration of the UC Booster Server is performed with the **Initial Installation** wizard of the WBM of the communication system. A description of the configuration can be found in the section "Initial installation of OpenScape Business X".

The **Initial Installation** wizard of the WBM includes the initial configuration of the entire communication system. The following configuration components are important for the operation of the OpenScape Business UC Booster Server:

- Selection of the UC solution  
You can select whether the UC solution UC Smart or UC Suite is to be used. The IP address of the Linux server must be entered for this purpose. Changing the UC solution leads to a restart of the communication system.

In addition, the IP address of the communication system must be made known at the WBM of the UC Booster Server.

### 6.4.3.1 Announcing the IP Address of the Communication System

#### *Prerequisites*

- The UC Booster Server is integrated in the customer LAN and operational.
- The OpenScape Business communication system is operational.

#### *Step by Step*

- 1) Start the web browser on the Linux PC and invoke the WBM of the OpenScape Business server at the following address:

```
https://<IP address of the Linux server>, e.g., https://  
192.168.1.10
```

- 2) If the browser reports a problem with a security certificate, install the certificate (using the example of Internet Explorer V10).
  - a) Close the web browser.
  - b) Open the web browser with administrator rights by clicking the right mouse button on the web browser icon and selecting the menu item **Run as administrator** from the context menu.
  - c) Allow the User Account Control.
  - d) Open the WBM of the OpenScape Business server at the following address:

```
https://<IP address of the Linux server>, e.g., https://  
192.168.1.10
```
  - e) Click on **Continue to this website**.

- f) Click on the message **Certificate Error** in the navigation bar of the web browser.
  - g) Click on **View Certificates**.
  - h) Click on **Install Certificate** (only visible with administrator rights).
  - i) Select the option **Local Computer** and confirm with **Next**.
  - j) Select the option **Place all certificates in the following store**, click **Browse** and specify **Trusted Root Certification Authorities**.
  - k) Confirm with **OK** and then with **Next** and **Finish**.
  - l) Confirm the certificate import with **OK** and close the certificate window **OK**.
  - m) Close the web browser.
  - n) Start the web browser again (without administrator rights) and invoke the WBM of the OpenScape Business sever at the following address:  

```
https://<IP address of the Linux server>, e.g., https://192.168.1.10
```
- 3) Click on the language code at the top right and select the language in which the user interface of the WBM is to be displayed from the menu. The Login page will be displayed in the selected language.
- 4) In the field under **Login**, enter the default user name `administrator@system` for access as an administrator.

---

**INFO:** If you go to the **Password** field after entering `administrator, @system` will be added automatically.

---

- 5) In the second field under **Login**, enter the dStart the web browser on the Linux PC and invoke the WBM of the OpenScape default password `administrator` for access as an administrator.
- 6) Click **Login**.
- 7) The following steps are only required once when first logging on to the WBM:
- a) Reenter the default password **administrator** in the `Password` field.
  - b) Enter a new password in the **New Password** and **Confirm New Password** fields to protect the system against misuse. Note case usage and the status of the `Num` und `CapsLock` keys. The password is displayed as a string of asterisks (\*).

---

**INFO:** The password must be at least 8 characters long and include a digit. Make sure that you remember your new password.

---

- c) Click **Login**.
- d) Select the current date and enter the correct time.
- e) Click **OK & Next**. You are automatically logged out of the WBM.



- f) In the field under **Login**, enter the default user name `administrator@system` for access as an administrator.

---

**INFO:** If you go to the **Password** field after entering `administrator, @system` will be added automatically.

---

- g) In the second field under **Login**, enter your new password for access as an administrator.
- h) Click **Login**. The home page of the WBM appears.
- i) Click on **Administrators** in the navigation bar.
- j) In the **Administrators List**, select the check box before the list item **Administrator**.
- k) Click **Edit**.
- l) In the **User role** drop-down list, select the user profile **Expert**.
- m) Click **OK & Next**.
- n) Log out from the WBM via the **Log Out** link at the top right.
- o) Log into the WBM again with the default user name `administrator@system` and the newly defined password.
- 8) In the navigation bar, click on **Expert Mode**.
- 9) Click **Maintenance > Configuration** in the navigation tree.
- 10) On the **Change Gateway IP Address** tab, under **Gateway IP Address**, enter the IP address of the communication system (e.g., `192.168.1.2`).
- 11) Click **Apply**.

## 6.4.4 Updating the Software for the UC Booster Card

In order to ensure that the UC Booster Server operates correctly, the software of the communication system and the communication software of the UC Booster Server must be updated to the same software level.

If the software of the communication system is already up-to-date, only the software of the UC Booster Server needs to be updated.

The software update can be optionally performed via the Internet or via an image file, which can be obtained from the Software Download Server. When updating the UC Booster Server via the image file, make sure that the image file containing the UC Booster Server portions (`osbiz..._pcx.tar`) is used.

## 6.5 Basic Configuration

During the basic configuration, the most important settings for the operation of the OpenScape Business UC Booster are defined.

The basic configuration for both the UC Booster Card and the UC Booster Server are performed by using the **Basic Installation** wizard of the WBM of the communication system. A description of the basic configuration can be found in the section Initial Installation of OpenScape Business X.

The basic configuration covers the configuration of the entire communication system. The following configuration items are important for the operation of the OpenScape Business UC Booster:

- **Station data**  
Special phone numbers required for the operation of the OpenScape Business UC Booster can be adapted as required. For example, the call number of the UC Suite voicemail box must be specified here.
- **Configuring the UC Booster Card**  
If a UC Booster Card is integrated in the communication system, the automatic configuration of the UC Booster Card must be initiated.
- **Meet-Me conference settings**  
The Meet-Me conference feature is available with OpenScape Business UC Booster. The pre-assigned call number and the pre-assigned dial-in number for the Meet-Me conference can be changed.

## 6.6 Closing Activities

After the initial installation and the basic installation with the WBM have been completed, some important settings must still be made for the operation of the OpenScape Business UC Booster.

The closing activities for both the UC Booster Card and the UC Booster Server are performed with the WBM of the communication system. A description of the closing activities can be found in the online help or in the OpenScape Business Administrator Documentation under the section "Initial Installation of OpenScape Business X".

The following closing activities are important for the operation of the OpenScape Business UC Booster:

- **Activate and assign licenses**  
If the OpenScape Business UC Booster is being integrated in an already licensed communication system, the licenses must be activated immediately in order to use its functionality. If the OpenScape Business UC Booster is being integrated in a communication system that has not yet been licensed, the licenses must be activated within a period of 30 days. Once the licenses have been activated successfully, they must be assigned to the stations. In a standalone system, system-wide features are enabled automatically upon activation.
- **Provision the UC Clients for installation**  
The UC clients are part of the UC Suite. The installation files for the UC Client are accessible via the WBM and can be made available to the IP stations automatically or manually.

- Perform a data backup  
All previous changes to OpenScape Business must be backed up. The backup can be stored as a backup set on a USB storage device or on the internal network.  
For the UC Booster Card, it is sufficient to perform a backup of the communication system. For the UC Booster Server, the data of the communication system and the data of the communication software of the UC Booster Server must be backed up separately.

## 6.7 Uninstalling the Communication Software

The software communication can be uninstalled via a text console.

### 6.7.1 How to Uninstall the Communication Software

#### *Step by Step*

- 1) Open a terminal (e.g., a GNOME terminal).
- 2) Enter the command `su` (for superuser = root) in the shell interface and confirm it by pressing the Enter key.
- 3) Enter the password for the "root" user in the shell interface and confirm it by pressing the Enter key.
- 4) Enter the command `oso_deinstall.sh` in the shell interface and confirm it by pressing the Enter key. Follow the instructions of the uninstallation program.

## 6.8 Upgrading from the UC Booster Card to the UC Booster Server

In order to upgrade an OpenScape Business communication system with an integrated UC Booster Card to an OpenScape Business communication system with a connected UC Booster Server, the following steps must be performed as described below:

#### **Upgrade Steps**

Perform the following steps in sequence:

1. **Back up the configuration data**  
Perform a backup of the configuration data of the communication system. For a description of the backup procedure, see [Backing up the Configuration Data of the Communication System](#).

2. **Change the IP address of the UC Booster Card**  
Using the **Initial Installation** wizard in the WBM of the communication system, change the IP address of the UC Booster Card to an unused IP address. The UC clients will be disconnected.  
For a description of how to change the IP address, see [System Settings](#).
3. **Change the application selection**  
Using the **Initial Installation** wizard in the WBM of the communication system, change the application selection from **Package with UC Suite** to **Package with UC Suite on OSBiz UC Booster Server** if you are using UC Suite (or from **Package with UC Smart** to **Package with UC Smart on OSBiz UC Booster Server** if you are using UC Smart) and enter the former IP address of the UC Booster Card as the IP address of the UC Booster Server.  
For a description of the application selection, see [UC Solution](#).
4. **Installing the Linux Server**  
The Linux operating system approved for the UC Booster Server must be installed on the Linux server.  
A description of the Linux installation can be found in the OpenScape Business Linux Server Installation Guide.
5. **Change the IP address of the UC Booster Server.**  
The former IP address of the UC Booster Card must be specified as the IP address of the UC Booster Server (= IP address of the Linux server). You can enter the IP address of the Linux server during the installation of the Linux operating system or change this later using YaST.  
For a description of IP address assignment during the Linux installation, see the OpenScape Business Linux Server Installation Guide.
6. **Install the communication software**  
The OpenScape Business communication software must be installed on the Linux server.  
For a description of the installation of the communication software, see [Installing the Communication Software](#).
7. **Configuring the UC Booster Server**  
Enter the IP address of the communication system in the WBM of the UC Booster Server.  
For a description of IP address assignment of the communication system, see [Configuring the UC Booster Server](#).
8. **Restart the communication software**  
Restart the UC Booster Server communication software via the WBM of the UC Booster Server.  
For a description of the restart, see [Restarting the UC Application](#).
9. **Update the software**  
The software of the communication system and the UC Booster Server must be updated to the same software level.  
For a description of the software update, see [Updates](#).
10. **Restore the configuration data**  
Restore the backed up configuration data of the communication system in the WBM of the communication system. The communication system and the

communication software are subsequently restarted, and the connections to the UC Suite clients are restored.

For a description of how to restore data, see [Restore](#).

## 6.9 Used Ports

The OpenScape Business system components use different ports, which may need to be opened in the firewall as required. For the ports of the web-based clients (e.g., myPortal to go), port forwarding must be configured in the router.

---

**INFO:** The ports identified with "O" in the list below are optional, i.e., are not permanently open in the firewall (e.g., the TFTP port is open only when Gate View is activated).

---

Description	TCP	UDP	Port number	OpenScape Business X	UC Booster Card	OpenScape Business S	UC Booster Server
<b>System components</b>							
Admin Portal (https)	X		443	X	X	X	X
CAR Update Registration	X		12061	X		X	
CAR Update Server	X		12063	X		X	
CLA	X		61740	O		O	O
CLA Auto Discovery		X	23232	X		X	X
Csta Message Dispatcher (CMD)	X		8900		X	X	X
CSTA Protocol Handler (CPH)	X		7004	X		X	
Csta Service Provider (CSP)	X		8800		X	X	X
DHCP		X	67	X			
DLI	X		18443	X		X	X
DLSC	X		8084	X		X	X
DNS	X	X	53	X			
FTP	X		21	O		O	
FTP Passive	X		40000:40040	O		O	
Gate View	X		8000:8010		O	O	O
HFA	X		4060	X		X	
HFA Secure	X		4061	X		X	
JSFT	X		8771		X	X	X
JSFT	X		8772		X	X	X
LAS Cloud Service	X		8602	X			

## Initial Setup of OpenScape Business UC Booster

### Used Ports

Description	TCP	UDP	Port number	OpenScape Business X	UC Booster Card	OpenScape Business S	UC Booster Server
LDAP server	X		389		X	X	X
Manager E	X		7000	X			
MEB SIP	X		15060		X		X
NAT traversal (NAT-T)		X	4500	X			
NTP		X	123	X			
Openfire Admin (https)	X		9091		X	X	X
OpenScape Business Multisite	X		8778		X	X	X
OpenScape Business myReports (http)	X		8101		X	X	X
OpenScape Business status server	X		8808	X		X	X
OpenScape Business user portal	X	X	8779		X	X	X
Postgres	X		5432	X	X	X	X
RTP (embedded)		X	29100:30530	X	X	X	X
RTP (server)		X	29100:30888	X	X	X	X
SIP (server)	X	X	5060	X		X	
SIP TLS SIPQ (server)	X		5061	X		X	
SIP TLS Subscriber (server)	X		5062	X		X	
SNMP (Get/Set)		X	161	X		X	
SNMP (traps)		X	162	X		X	
TFTP		X	69		O	O	O
VSL	X		8770		X	X	X
Webadmin for Clients	X		8803	X	X	X	X
XMPP Connection Manager	X		5262		X	X	X
XMPP server	X		5269		X	X	X
<b>Web-based clients</b>							
Web-based clients (http)	X		8801	X	X	X	X
Web-based clients (https)	X		8802	X	X	X	X

---

**INFO:** For security reasons, we recommend that only https be used for the web-based clients and that port forwarding be set up from external TCP/443 to internal TCP/8802.

---

## 7 Licensing

The flexible licensing concept of OpenScape Business allows customers to adapt the functional scope to their own requirements through licenses. All OpenScape Business X and OpenScape Business S communication systems are subject to this license concept. Phones, UC clients, UC functions and system-wide features can thus be unlocked according to individual customer needs. Uniform licenses are used for all OpenScape Business communication systems.

OpenScape Business can be expanded or equipped with additional features at a later date by purchasing additional licenses.

All licenses are always bound to the basic license of the communication system and enable the use of the purchased features for the associated version of OpenScape Business.

90-day evaluation licenses can be ordered to allow customers to test and evaluate special features.

### Activation Period

The license activation must be completed within the activation period (duration of 30 days). The activation period begins when the current date is entered in the WBM. The expiration date of the activation period is stored in the process.

During the activation period, the product is fully functional, and the maximum number of licenses are available for use.

If the system loses the current date within the activation period (e.g., due to a discharged battery on the mainboard), the date must be updated in the WBM as soon as possible so that the system can continue to be used without restrictions during the activation period.

If the licensing is not completed before the activation period expires, the functionality of the communication system will be severely restricted. Internal communication between the individual stations is still possible, but only the first two active phones can make external calls (e.g., for emergency calls). Access to the communication system via Remote Access is still possible. The system also remains in this restricted state when the initial installation is carried out only with Manager E, since this does not start the activation period.

### License Structure

The licenses for the communication system are structured as follows:

- A basic license permanently activates the software of the communication system. This basic license is also required for activating all other licenses.
- Station licenses activate the phones for external voice communications.
- User-oriented licenses to unlock specific user features.
- System licenses to unlock general system-wide features.

## Migration

Existing HiPath 3000 V9 customers are being offered an upgrade license for license migration. License migration ensures investment protection for customers through continued use of telephones and voice features.

## 7.1 Licensing Procedure

Licensing is handled via the centralized OpenScape License Management procedure for the administration and activation of licenses. This ensures that a customer can use precisely the system configuration or features for which that customer has acquired the appropriate licenses (usage rights).

The licenses of the OpenScape Business communication systems are bound to the Locking ID or the Advanced Locking ID of the communication system (see [Locking ID and Advanced ID Locking](#)).

The customer orders the required features and receives a License Activation Code (LAC). After a successful initial installation of the communication system, the customer activates the acquired licenses via a license file. The license file provides the system with a license pool with all purchased licenses available for the subsequent allocation of licenses.

The WBM provides wizard-driven functions for the customer registration, license activation and the license assignments for standalone systems and systems in an OpenScape Business internetwork. Licensing with Manager E is not possible.

### Steps for Successful Licensing

1. Configuration of the system within the activation period
2. Registration of customer data
3. License Activation
4. Assigning Licenses

### Customer Registration

Within the framework of licensing, the input of the customer data of each respective system is mandatory for the registration of the customer. The customer data is used to retrieve information quickly in the case of security-related issues, especially in the context of product recalls. In addition, customers receive information on prevention of license misuse by third parties, e.g., via the new link to the license information.

### License Activation

During the license activation, the purchased licenses are bound to the communication system using the license management of the WBM. Two methods are available for this:

- Online activation

For online activation, after the LAC is entered via the Internet, a connection to the Central License Server (CLS) is set up, and the license file is automatically transferred to the integrated license agent (Customer License



Agent, CLA) in the communication system. The licenses are then automatically activated.

- **Offline activation**  
With offline activation, the communication system is not connected to the Central License Server (CLS). The license file is generated at the CLS by an authorized partner and must be transmitted manually during the license activation to the integrated license agent (Customer License Agent, CLA) in the communication system.

### **Assigning Licenses**

All purchased licenses are permanently assigned to stations via the license management of the WBM.

To assign licenses to stations, the stations must be first set up with the WBM, e.g., during the initial installation. Each system configuration can be set independently of the existing licenses. However, the corresponding feature can only be used once the license have been assigned.

When assigning licenses, a distinction is made between the configuration and actual licensing. For station and user-oriented licenses, licence requests are first configured. If a license is available in the license pool for a license request, the corresponding feature is unlocked. If no license is available in the license pool, the configured license request is retained, but the corresponding feature is not unlocked. Missing licenses must be purchased if needed.

### **Licensing in an Internetwork**

For an OpenScape Business internetwork, a network-wide license file (network license file) is generated by an authorized partner at the Central License Server (CLS). This network-wide license file is managed by the Central License Agent (CLA) of the master node and provides the licenses for the individual nodes. The assignment of the licenses occurs via the WBM of each individual node. Within an internetwork, the network licenses can be shifted freely by using the WBM.

Online activation is not possible when licensing an internetwork.

### **Pay As You Go**

Apart from the traditional licensing scheme, OpenScape Business supports subscription licensing model (Pay As You Go). "Pay As You Go" gives the opportunity to invoice only for the used licenses on each billing period and use extra licenses without extending the license file. There is no need to decide the amount of the licenses beforehand

A permanent internet connection from OpenScape Business system to the Central License Server (CLS) is required. It can be activated either online with a License Activation Code (LAC) or with file upload. After installing, configuring the solution according to the custom needs and activating "Pay As You Go" a periodically report of the used licenses are sent to the Central License Server (CLS) and is evaluated. Once a month, a final report is created on the Central License Server (CLS) product site and the content of used licenses of this final report is used for license accounting.

With subscription licensing a new time period is introduced, the qualifying period. The qualifying period starts with the system startup or if a "Pay As You Go" license file is activated. The period starts consecutively and during this period a license configuration done in WBM will not lead to license usage update. The maximum duration of the qualifying period is 2 hours.

---

**INFO:** In order the firewall to have access to CLS the following actions are needed:

-) 7780 und 7790 Ports for incoming and outgoing IP traffic released

-) 188.64.16.4 released for incoming and outgoing IP traffic

---

## 7.2 Licenses

To use the features of the communication system, licenses must be purchased. The purchased licenses must be activated within a given period of time (activation period).

Licenses are categorized thematically into license groups. The following license groups are available:

- Basic Licenses
- Station Licenses
- User-oriented Licenses
- System licenses

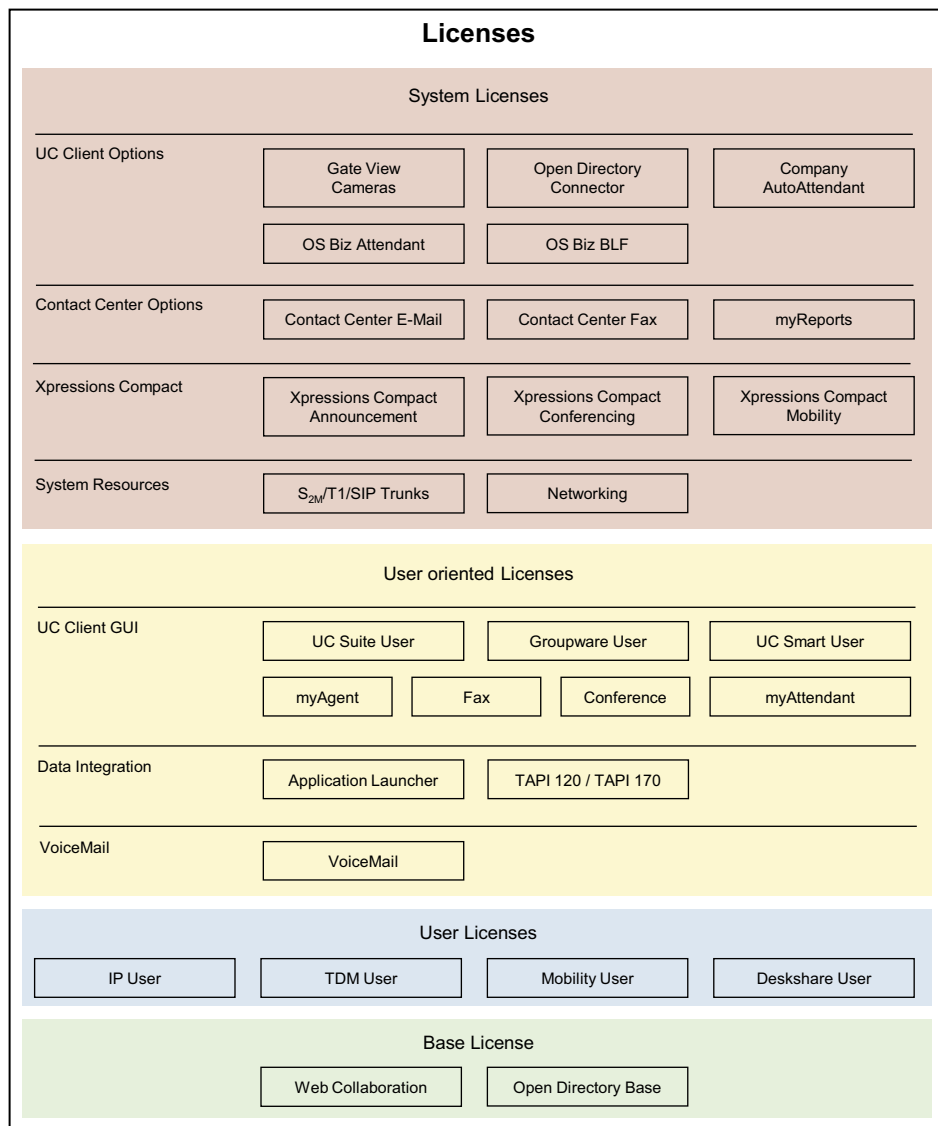

The above licenses can be used for OpenScape Business X, OpenScape Business S and the OpenScape Business UC Booster Server. There is no basic license for the UC Booster Server. The licenses cover all features and can be combined in accordance with the wishes of the customer. The possible combinations of licenses are explained in greater detail in the "Assigning Licenses and License Profiles" section.

Station licenses and user-oriented licenses are permanently assigned to subscribers.

## 7.2.1 Basic License

A basic license permits the basic use of the communication system. It is also required for activating all other licenses.

Internet telephony and emergency operation is also possible without a basic license.

The following basic licenses are available:

- **OpenScape Business V2 X1 Base**  
for unlocking the V2 functionality of
  - OpenScape Business X1The basic license additionally includes the licenses OpenDirectory Base for using the Open Directory Service (ODS) and Web Collaboration for starting a web collaboration session. This makes it possible for the UC solution UC Smart to be connected to an external database.
- **OpenScape Business V2 Base**  
for unlocking the V2 functionality of
  - OpenScape Business X3/X5/X8 with or without UC Booster (UC Booster Card or UC Booster Server) or
  - OpenScape Business SThe basic license additionally includes the license OpenDirectory Base for using the Open Directory Service (ODS) and Web Collaboration for starting a web collaboration session. This makes it possible to connect the UC solutions UC Suite or UC Smart to an external database.

## 7.2.2 Station Licenses

Every subscriber connected to the communication system requires a station license to make external calls. This license is permanently bound to the call number of the subscriber via the WBM.

Station licenses include the comprehensive voice functionality of OpenScape Business. Additional licenses are required to use the UC solutions UC Smart or UC Suite (see [User-oriented Licenses](#)).

The following station licenses are available:

- **IP User**  
For the use of IP system telephones (HFA) and SIP telephones.
- **TDM User**  
For the use of UP0 system phones, analog phones, analog fax devices, ISDN phones, ISDN fax and DECT phones.
- **Mobility User**  
For the use of GSM/mobile phones, smartphones and tablet PCs as an extension of the communication system. For the use of myPortal to go and Mobility Entry. The assignment of an additional desk phone is not required.
- **DeskShare User**  
For use of the DeskSharing feature. Only a phone number and no physical phone is permanently assigned to such users. DeskShare users can operate specific IP system phones using their permanently assigned phone number, and they can access their personal phone settings on these phones.

### Flexible User Licensing

With the flexible user licensing, TDM, Mobility and Deskshare users can also be licensed with IP user licenses. If all the acquired TDM, DeskShare and Mobility user licenses have already been assigned to subscribers, and further TDM, DeskShare and Mobility users are required, then any remaining IP User licenses can be used to meet this demand.

The use of flexible user licensing requires the software version V1R3.3 and a newly generated license file at the CLS, which must be imported into the OpenScape Business and activated.

### UC-Suite Flexible User Licensing

With the UC-Suite flexible user licensing, myPortal for Desktop users can also be licensed with myPortal for Outlook user licenses. If all the acquired myPortal for Desktop licenses have already been assigned, and further users are required, then the myPortal for Outlook User licenses can be used to meet this demand.

The use of flexible user licensing requires the software version V2 and a newly generated license file at the CLS, which must be imported into the OpenScape Business and activated.

---

#### Related Topics

- [Assigning Licenses \(Standalone\)](#)

## 7.2.3 User-oriented Licenses

User-oriented licenses are station-based and authorize the use of unified communications features and data integration applications. A user-oriented license also requires a station license and is permanently assigned to the phone number of the subscriber.

The following user-oriented licenses are available:

#### Voicemail

- **Voicemail**  
For the use of a personal voicemail box via the telephone (TUI) and via the user interface of the UC solutions UC Smart or UC Suite.

---

**INFO:** If the UC solution UC Smart is expanded to UC Suite, the existing voicemail licenses and the assignments to the stations are retained.

---

## UC Client User Interface

- **UC Smart User**  
For the use of UC Smart functions of the communication clients myPortal Smart, myPortal to go, myPortal for OpenStage and other Web Services clients.
- **UC Suite User**  
For the use of UC Suite functions of the communications clients myPortal for Desktop, myPortal to go, myPortal for OpenStage and other Web Services clients.
- **Groupware user**  
For the use of UC Suite functions of the communications clients myPortal for Outlook, myPortal to go, myPortal for OpenStage and other Web Services clients.
- **Fax**  
For use of a fax box within the UC Suite. As a prerequisite, one UC Suite User or Groupware User license is required additionally.
- **Conference**  
For the use of the UC Suite conference management features, such as managing and initiating permanent and recurring conferences. As a prerequisite, one UC Suite User license or Groupware User license is required additionally.  
No license is required for participating in conferences.
- **myAttendant**  
For use of the UC Suite Attendant features.
- **myAgent**  
For the use of Contact Center functions such as information about queues, pop-ups with customer information on incoming calls, and access to the call history.
- **Upgrade from myPortal Smart to myPortal for Desktop**  
For upgrading the UC Client myPortal Smart to the UC Client myPortal for Desktop in order to use the full UC functionality such as conferencing and fax, for example.

---

**INFO:** For the mobile client myPortal to go, besides the Mobility User license, an additional UC Smart User license is required for the UC solution UC Smart, and an additional UC Suite User license or Groupware User license is required for the UC solution UC Suite.

---

## Data Integration

- **Application Launcher**  
For call-related control of applications on a client PC during incoming and outgoing calls, e.g., launching an application or displaying caller information. Application Launcher can be operated with UC Smart, UC Suite or myAgent and additionally requires a UC Smart User license (for UC Smart), a UC Suite User / Groupware User license (for UC Suite) or a myAgent license. It can optionally use the Open Directory Service.

- **OpenScape Business TAPI**  
For the use of TAPI compliant applications and for PC-supported telephony with the customer's own applications from various software vendors. The UC Booster (UC Booster Card or UC Booster Server) is a prerequisite.

## 7.2.4 System Licenses

System licenses are not subscriber-specific and unlock the system-wide features. These features can be used by all subscribers of the communication system.

The following system licenses are available:

### System Resources

- **S<sub>2M</sub>/T1/SIP trunks**  
For the use of S<sub>2M</sub>/T1 and ITSP channels. S<sub>0</sub> channels do not need to be licensed. This also includes connections to S<sub>0</sub> Fax servers in PP mode. For the primary multiplex connections S<sub>2M</sub> or T1 (USA), the individual voice channels are licensed. For ITSP connections, the number of simultaneous connections to one or more ITSP providers (SIP providers) is licensed. The number of possible simultaneous connections depends on the bandwidth of the connection.
- **Networking**  
For IP networking via SIP-Q/native SIP and/or TDM networking via CorNet-NQ or QSIG. For networking the UC Suite applications. One license is required per node.

---

**INFO:** The networking license unlocks the lines for voice networking and UC Suite networking for a node. No S<sub>2M</sub>/T1/SIP trunk licenses are required for network trunks.

---

**Table:** Overview of System Resource Licenses (S2M/ITSP)

Protocol	Licenses			
	No licence	OpenScape Business Networking (1x per system)	OpenScape Business S2M / ITSP (1x per channel)	TDM User
<b>S0 internal</b>				
Fax Server (DSS1/QSIG)	X			
Euro bus				per S0 station
<b>S0 - CO trunks</b>				
EURO CO PP	X			
Euro CO PMP	X			
<b>S2M - CO trunks</b>				

Protocol	Licenses			
	No licence	OpenScope Business Networking (1x per system)	OpenScope Business S2M / ITSP (1x per channel)	TDM User
EURO CO PP			X	
<b>ITSP - Provider</b>				
ITSP 1 to 8			X	
<b>S0 networking</b>				
QSIG		X		
CorNet-NQ		X		
<b>S2M - Networking</b>				
QSIG-Network		X		
CorNet-NQ		X		
<b>SIP Networking</b>				
SIP-Q		X		
native SIP		X		

#### Xpressions Compact

- **Xpressions Compact Announcement**  
For the use of Xpressions Compact Announcements features such as recording special announcements for information or attendant mailboxes. One license is required per Xpressions Compact.
- **Xpressions Compact Conferencing**  
For the use of Xpressions Compact Conference features such as managing and conducting conferences and controlling conferences through a web client. Six licenses can be purchased per Xpressions Compact.
- **Xpressions Compact Mobility**  
For the use of Xpressions Compact Mobility features such as the One Number Service (which enables a subscriber to be reached via a single phone number for all calls on all phones associated with that subscriber). Six licenses can be purchased per Xpressions Compact.

#### Contact Center Options

- **Contact Center Mail**  
For setting up one or more email boxes to send and receive emails for Contact Center agents. A station license and a myAgent license are required for this. One license is required per node.
- **Contact Center Fax**  
For setting up one or more fax boxes to send and receive faxes for Contact Center agents. A station license and a myAgent license are required for this. One license is required per node.



- **myReports**  
For the compilation of statistics on the utilization of Contact Center resources based on different criteria. Using the Schedule Manager, reports can be created from over 100 predefined report templates for telephone, email and fax contacts. The report templates are managed via the Report Manager, with functions for regrouping as well as adding and deleting newly created report templates.

### UC Client Options

- **Open Directory Connector**  
For connecting to the Open Directory Service (ODS) in order to enable access to an external database or an external directory. A maximum of four databases can be connected per node.
- **Company AutoAttendant**  
For the use of a central UC Smart or UC Suite based AutoAttendant to automatically transfer calls. One license is required per node. Announcements of the type "music on hold" (endless loop) are only played with this license.
- **Gate View cameras**  
For video surveillance, which provides real-time video images on your OpenStage phone, PC or smartphone. A separate license is required for each of the eight possible cameras within a node.
- **OpenScape Business Attendant**  
For using the OpenScape Business Attendant (PC attendant). Up to 8 OpenScape Business Attendants may be licensed per node. If OpenScape Business Attendant should also have access to presence information, a UC Smart or UC Suite User license is additionally required.
- **OpenScape Business BLF**  
For use of the additional Busy Lamp Field indicator of OpenScape Business BLF. For each subscriber, one BLF license and one UC Smart or UC Suite User license is required. Up to 50 OpenScape Business BLFs may be licensed per node.

## 7.2.5 Evaluation Licenses

An evaluation license can be used to test special features with full functionality over a fixed time period (called the evaluation period) free of charge. If a regular license for the feature is activated during the evaluation period, the evaluation license will be disabled.

The following evaluation licenses are available:

- **OpenScape Business V2 Service Evaluation**  
This evaluation license is intended for partners who want to first preconfigure the communication system in their own company and put it into service at the customer site later. The 30-day activation period begins during the preconfiguration. In order to restart the activation period of 30 days after

commissioning the system, this evaluation license must be activated from the customer site after starting up the system.

The activation is possible once per system and only within the activation period. If the activation period has expired, the system must be licensed with permanent licenses.

- **OpenScape Business V2 UC Smart Evaluation**

This evaluation license is intended for customers who want to test the UC features of UC Smart. All UC Smart features can be used with this evaluation license.

---

**INFO:** This evaluation license cannot be used if the communication system is located in an internetwork and the "Networking" license is active. If voicemail licenses are already available, they are used in combination with the new UC evaluation licenses.

---

- **OpenScape UC Suite V2 Business Evaluation**

This evaluation license is intended for customers who want to test the UC features of UC Suite. All UC Suite features can be used with this evaluation license.

---

**INFO:** This evaluation license cannot be used if the communication system is located in an internetwork and the "Networking" license is active. If voicemail licenses are already available, they are used in combination with the new UC evaluation licenses.

---

- **OpenScape Business V2 UC Gate View Evaluation**

This evaluation license is intended for customers who want to test the UC features of Gate View. All Gate View features can be used with this evaluation license.

---

**INFO:** This evaluation license cannot be used if the communication system is located in an internetwork and the "Networking" license is active.

---

- **OpenScape Business V2 UC Suite Contact Center Evaluation**

This evaluation license is intended for customers who want to test the Multimedia Contact Center. All features of the Multimedia Contact Centers can be used with the evaluation license.

---

**INFO:** If the Multimedia Contact Center is not licensed within the evaluation period, the administrator must undo the Contact Center settings (e.g., delete schedules and queues, deactivate agents, etc.) before the evaluation license expires. Otherwise, errors may occur in OpenScape Business.

---

- **OpenScape Business V2 CRM Evaluation**  
This evaluation license is intended for customers who want to test Application Launcher, Open Directory Service and TAPI.
- **OpenScape Business V2 Attendant Evaluation**  
This evaluation license is intended for customers who want to test the OpenScape Business Attendant application.
- **OpenScape Business V2 BLF Evaluation**  
This evaluation license is intended for customers who want to test the OpenScape Business BLF application (e.g., to independently display the busy lamp field and presence information).

#### Rules

- The activation of an evaluation license occurs at the Customer License Server (CLS) and can only be performed once.
- The evaluation period is 90 days. After 60 days, the remaining time in days is counted backwards on the display of system telephones.
- When the evaluation period expires, the feature is automatically disabled.
- Multiple evaluation licenses may be active simultaneously in the system, but may then end at different times.
- If a perpetual license is active, the evaluation license is not started or, if already present, is stopped.

## 7.2.6 Upgrade Licenses

Upgrade licenses are required to upgrade HiPath 3000 V9, OpenScape Office V3 and OpenScape Business V1 systems to OpenScape Business V2 systems.

The license migration of HiPath 3000 systems requires a running and possibly licensed HiPath 3000 V9 system. The steps for the hardware and license migration must be carefully observed (see also the [Migration](#)). Pure HiPath 3000 TDM systems without licenses must be first upgraded to Version 9 and can then be migrated to OpenScape Business with an upgrade license.

The following upgrade licenses are available:

- **HiPath 3000 V9 Upgrade to OpenScape Business V2**  
For the migration from HiPath 3000 V9 to OpenScape Business V2 X3/X5/X8.
- **HiPath 3000 V8 Upgrade to OpenScape Business V2**  
For the migration from HiPath 3000 V8 to HiPath 3000 V9 and then to OpenScape Business V2 X3/X5/X8.
- **HiPath 3000 V7 Upgrade to OpenScape Business V2**  
For the migration from HiPath 3000 V7 to HiPath 3000 V9 and then to OpenScape Business V2 X3/X5/X8.
- **OpenScape Office V3 MX/LX Upgrade to OpenScape Business V2**  
For the migration from OpenScape Office V3 MX/LX to OpenScape Business V2.

## 7.2.7 Possible License Combinations

The licenses can be combined as desired. This section contains some suggestions for possible license combinations that will allow you to use the desired functions.

Please note that multiple licenses are required for some functions.

### Telephony

- Required: IP User, TDM User or DeskShare User station license

---

**INFO:** Without a valid license, the phone can only be used for internal connections.

---

### Telephony with UC Smart

- Telephony with voicemail box (UC Smart)
  - Required: IP User, TDM User or DeskShare User station license
  - Required: user-oriented VoiceMail license
- Telephony with Mobility Entry (DISA-based mobility)
  - Required: Mobility User station license
- Telephony with myPortal Smart
  - Required: IP User, TDM User or DeskShare User station license
  - Required: user-oriented UC Smart User license
  - Optional: user-oriented VoiceMail license
- Telephony with myPortal to go
  - Required: Mobility User station license
  - No Mobility User license is required in the **Desk phone** (control of the Office telephone) mode.
  - Required: user-oriented UC Smart User license
  - Optional: user-oriented VoiceMail license
- Telephony with optiClient Attendant
  - Required: IP User, TDM User or DeskShare User station license
  - Required: OpenScape Business Attendant system license
  - Optional: user-oriented VoiceMail license
  - Optional: user-oriented UC Smart User license (for displaying the presence status)

### Telephony with UC Suite

- Telephony with voicemail box (UC suite)
  - Required: IP User, TDM User or DeskShare User station license
  - Required: user-oriented VoiceMail license
  
- Telephony with myPortal for Desktop
  - Required: IP User, TDM User or DeskShare User station license
  - Required: user-oriented UC Suite User license
  - Optional: user-oriented VoiceMail license
  - Optional: user-oriented Fax license
  - Optional: user-oriented Conference license
  
- Telephony with myPortal for Outlook
  - Required: IP User, TDM User or DeskShare User station license
  - Required: user-oriented Groupware User license
  - Optional: user-oriented VoiceMail license
  - Optional: user-oriented Fax license
  - Optional: user-oriented Conference license
  
- Telephony with myPortal to go
  - Required: Mobility User station license  
No Mobility User license is required in the **Desk phone** (control of the Office telephone) mode.
  - Required: user-oriented UC Smart User license
  - Optional: user-oriented VoiceMail license
  
- Telephony with myAttendant
  - Required: IP User, TDM User or DeskShare User station license
  - Required: user-oriented myAttendant license
  - Optional: user-oriented VoiceMail license

### Using the Contact Center

- Required: IP User, TDM User, DeskShare User or Mobility User station license
- Required: user-oriented myAgent license
- Optional: Contact Center Email system license
- Optional: Contact Center Fax system license
- Optional: myReports system license

### Using the Company AutoAttendant

- Required: Company AutoAttendant system license

## 7.3 Licensing a Communication System (Standalone)

The licensing of a standalone system must be performed in a specific order. This order is given in our example for one of the OpenScape Business X communication systems.

The following subsections describe how Step 3 and Step 4 can be performed using the WBM.

### 1. License Authorization Code (LAC)

On purchasing licenses, the customer receives a License Authorization Code (LAC). The information on the licenses purchased are stored in the database of the Central License Server (CLS).

### 2. Installation and Configuration

The customer or service technician uses the WBM wizard to install and configure the communication system (including the stations and lines). When you first launch the WBM, you must enter the current date. This starts the activation period (i.e., the period of 30 days during which the licensing has to be completed).

### 3. License Activation

The customer or service technician uses the WBM to activate the licenses either online using a License Authorization Code (online license activation) or offline using a license file (offline license activation).

### 4. Assigning Licenses

The customer or service technician uses the WBM to assign the purchased licenses to stations and lines. Once the licenses have been assigned successfully, the licensed features are activated.

---

#### Related Topics

- [Activating Licenses \(Standalone\)](#)
- [Assigning Licenses \(Standalone\)](#)

### 7.3.1 Activating Licenses (Standalone)

After purchasing a product or feature, you must first activate the licenses provided with the product or feature. After successful activation of the licenses, the licenses are assigned.

Licenses can be activated by one of the following two methods:

- **Online license activation** (via the license authorization code)  
Using the WBM, the customer or service technician transmits the license authorization code to the Central License Server (CLS) via the Internet. Together with the LAC, the Locking ID of the communication system is used

for license activation. The CLS creates a license file from the data and sends this back to the system, which then activates the licenses purchased. To access the CLS, you will need an Internet connection. The IP address of the CLS is saved in the WBM under **License Management > Settings** and can be changed by an administrator with the **Expert** profile if required.

---

**INFO:** By default, port 7790 is used for the online license activation. This port must be enabled in the firewall of the customer network.

---

---

**INFO:** Before the online licensing can be performed, the registration data must first be entered correctly.

---

- **Offline license activation** (using the license file)  
The customer or service technician logs in at the Central License Server (CLS) and enters the license authorization code there along with the Locking ID of the communication system. The CLS generates a license file from the data entered. The customer or service technician downloads the license file and copies it into the WBM. The system then activates the purchased licenses. The IP address of the CLS is saved in the WBM under **License Management > Settings** and can be changed by an administrator with the **Expert** profile if required.

If the communication system is to be expanded, further licenses can be purchased. On purchasing more licenses, an additional License Authorization Code (LAC) with which the newly procured licenses can be activated is supplied.

---

**INFO:** Additionally purchased licenses can also be activated remotely.

---

---

#### **Related Topics**

- [Assigning Licenses \(Standalone\)](#)
- [Licensing a Communication System \(Standalone\)](#)

### **7.3.1.1 How to Activate Licenses Online (Standalone)**

#### **Prerequisites**

- You are logged on to the WBM with the **Advanced** profile.
- You know the License Authorization Code (LAC) needed to release the license.
- In order to access the License server, the communication system must have access to the Internet.

## Licensing

### Licensing a Communication System (Standalone)

Licenses with Locking ID: 00.1a.e8.5d.09.90

License Authorization Code (LAC)

I have the user name and password for the License Server and want to log on.

User name

Password

Note: The response from the License Server can take up to 90 seconds!

#### Step by Step

- 1) Click on **License Management** in the navigation bar.
- 2) In the navigation tree, click on **Registration**.
- 3) Enter your data and click **OK**.
- 4) In the navigation tree, click **Activate License Online**.
- 5) Enter the appropriate LAC in the **License Authorization Code (LAC)** field.
- 6) Select the check box **I have the user name and password for the License Server and want to log on**.
- 7) Enter the **User Name** and **Password** for logging into the License Server.
- 8) Click on **Activate**. The connection to the License Server is established, and the licenses are transferred to the communication system. Following the successful release, the connection is automatically reestablished.

### 7.3.1.2 How to Activate Licenses Offline (Standalone)

#### Prerequisites

- You are logged on to the WBM with the **Advanced** profile.
- The license file was generated earlier at the Central License Server and saved. You know the storage location of the license file.

#### Step by Step

- 1) Click on **License Management** in the navigation bar.
- 2) In the navigation tree, click **Activate License File**.
- 3) Under **License File**, click **Browse** and select the storage location of the license file.
- 4) Click on **Activate**.







## 7.3.2 Assigning Licenses (Standalone)

Once the purchased licenses have been activated successfully, they must be assigned to the stations and lines. In a standalone system, system-wide features are enabled automatically upon activation.

### Assigning Station Licenses and User-oriented Licenses

Subscribers can be assigned station licenses and user-oriented licenses.

Station licenses can be assigned to the following subscriber types:

Icon	Station license	Description
	IP stations	For the use of IP system telephones (HFA or SIP) and SIP telephones
	TDM stations	For the use of UP0 system phones, ISDN phones, analog phones and DECT phones
	Mobile stations	For the use of myPortal to go, Mobility Entry and DISA (One Number Service)
	DeskSharing stations	For the use of Desk Sharing by IP stations

The station licenses are permanently assigned to the numbers of the subscribers. If a subscriber is deleted or if another subscriber type is assigned to a call number, the associated station license is released.











With the flexible licensing, TDM, Mobility and Deskshare users can also be licensed with IP user licenses. If all the acquired TDM, DeskShare and Mobility user licenses have already been assigned to subscribers, and further TDM, DeskShare and Mobility users are required, then any remaining IP User licenses can be used to meet this demand.

After a station license has been assigned to the subscriber, a user-oriented license can also be assigned to that subscriber.

The following user-oriented licenses can be assigned to the stations:

## Licensing



### Licensing a Communication System (Standalone)





Icon	User-oriented license	Description
	Voicemail	For the use of the voicemail box.
	UC Smart	For the use of the UC Smart features via myPortal Smart.
	Groupware user	For the use of the UC Suite features via myPortal for Outlook.
	UC Suite	For the use of the UC Suite features via myPortal for Desktop.
	Fax	For use of a fax box within the UC Suite. As a prerequisite, one UC User or Groupware User license is required.
	Conference	For use of the UC Suite conference features. As a prerequisite, one UC User or Groupware User license is required.
	myAttendant	For use of the UC Suite Attendant features.
	myAgent	For the use of Contact Center functions.
	Application Launcher	For call-related control of applications on a client PC during incoming and outgoing calls, e.g., launching an application or displaying caller information.
	TAPI 120/170	For the use of TAPI compliant applications and for PC-supported telephony with the customer's own applications from various software vendors.

You can have an overview of all station licenses and user-oriented licenses displayed (via **Local User Licenses > Overview**).

This overview also shows the statuses of the licenses for each subscriber.

Possible license states:

Symbol	Explanation
	Successfully licensed.
	Unsaved license release.
	Not licensed

Symbol	Explanation
	Unsaved license demand release.
	License demand configurable.
	Unsaved license demand.
	License demand not configurable.

### Assigning System Licenses

System licenses include licenses for trunks and for system-wide features.

Licenses can be assigned to the following types of trunks:

- S<sub>2M</sub>/T1 trunks: number of B channels
- ITSP trunks: number of simultaneous calls conducted via a single ITSP

In a standalone system, licenses for system-wide features will have already been unlocked by default during the license activation. Consequently, no further assignment is required.

### License assignment procedure

Prerequisite: The license file is activated and the stations are configured.

- How to License Stations
  - a) Assign a station license to a subscriber. This assignment triggers the generation of a license request for the subscriber while at the same time enabling the assignment of the user-oriented licenses.
  - b) Assign the user-oriented licenses to a subscriber. These assignments cause further license requests to be generated for the subscriber. Please note that some licenses require other licenses (see [Possible License Combinations](#)).
  - c) Check and unlock license requests.
  - d) If there are not enough licenses to be unlocked, the invalid assignments will be displayed via the license statuses (in red). Correct the license assignments and then check and unlock the licenses again.

---

**INFO:** To obtain a better overview, you can have the license assignments for all subscribers printed out as a preview (via **Local User Licenses > Overview > Print**). At the end of the printout, all invalid assignments are listed in a separate table.

---

- Assign trunk licenses  
The trunk licenses must be distributed to the required S<sub>2M</sub>/T1 and ITSP trunks.

---

### Related Topics

- [Licensing a Communication System \(Standalone\)](#)
- [Activating Licenses \(Standalone\)](#)
- [Station Licenses](#)

## Licensing

Licensing a Communication System (Standalone)

### 7.3.2.1 How to License Subscribers (Standalone)

Assign the available station licenses and user-oriented licenses to the subscribers. Once the licenses have been assigned successfully, the subscribers are licensed.

#### Prerequisites

- You are logged on to the WBM with the **Advanced** profile.

#### Step by Step

- Click on **License Management** in the navigation bar.
- In the navigation tree, navigate to the desired type of subscriber under **Local User Licenses > ...**. You will be shown a list of all subscribers of the selected subscriber type.

Under **Remaining licenses**, you will see how many licenses you can still assign to subscribers. For TDM, Mobility and Deskshare stations, the display includes all remaining IP User licenses as well, since these licenses can also be used for the licensing of TDM, Mobility and Deskshare stations (flexible user licensing).

- Activate the station license in the row of the desired subscriber by selecting the highlighted check box with a bright background (first column with check boxes). The check boxes in the other columns are enabled.

**INFO:** You can also have a selected station displayed by entering a search term in the **Station Number** or **Name** search fields and then pressing the Enter key or clicking the magnifying glass icon. All stations will be listed if you leave both search fields empty and then press the Return key or click on the magnifying glass icon.

The screenshot shows the 'License Management' interface. On the left is a navigation tree with 'Local User licenses' expanded to 'IP User'. The main area displays a table titled 'IP User' with search fields for 'Call number' and 'Name'. The table has columns for 'Access', 'Call number', 'Name', and a 'Remaining licenses' column followed by 11 columns of license types, each with a check box. The 'Remaining licenses' column shows values: 5, 5, 5, 0, 0, 0, 0, 0, 0, 0, 0, 0. The first row has a highlighted check box in the first license column.

Access	Call number	Name	Remaining licenses	UC	UC	UC	UC	UC	UC	UC	UC	UC	UC	UC	UC	UC	UC	UC
			5	5	5	0	0	0	0	0	0	0	0	0	0	0	0	0
LAN 0-SYS-9	110	Natalie Dubois	<input checked="" type="checkbox"/>	<input type="checkbox"/>	<input type="checkbox"/>	<input type="checkbox"/>	<input type="checkbox"/>	<input type="checkbox"/>	<input type="checkbox"/>	<input type="checkbox"/>	<input type="checkbox"/>	<input type="checkbox"/>	<input type="checkbox"/>	<input type="checkbox"/>	<input type="checkbox"/>	<input type="checkbox"/>	<input type="checkbox"/>	<input type="checkbox"/>
LAN 0-SYS-5	120	Pierre Martin	<input type="checkbox"/>	<input type="checkbox"/>	<input type="checkbox"/>	<input type="checkbox"/>	<input type="checkbox"/>	<input type="checkbox"/>	<input type="checkbox"/>	<input type="checkbox"/>	<input type="checkbox"/>	<input type="checkbox"/>	<input type="checkbox"/>	<input type="checkbox"/>	<input type="checkbox"/>	<input type="checkbox"/>	<input type="checkbox"/>	<input type="checkbox"/>
LAN 0-SYS-6	130	Claudia Ferraro	<input type="checkbox"/>	<input type="checkbox"/>	<input type="checkbox"/>	<input type="checkbox"/>	<input type="checkbox"/>	<input type="checkbox"/>	<input type="checkbox"/>	<input type="checkbox"/>	<input type="checkbox"/>	<input type="checkbox"/>	<input type="checkbox"/>	<input type="checkbox"/>	<input type="checkbox"/>	<input type="checkbox"/>	<input type="checkbox"/>	<input type="checkbox"/>
LAN 0-SYS-7	140	Giovanni Rossi	<input type="checkbox"/>	<input type="checkbox"/>	<input type="checkbox"/>	<input type="checkbox"/>	<input type="checkbox"/>	<input type="checkbox"/>	<input type="checkbox"/>	<input type="checkbox"/>	<input type="checkbox"/>	<input type="checkbox"/>	<input type="checkbox"/>	<input type="checkbox"/>	<input type="checkbox"/>	<input type="checkbox"/>	<input type="checkbox"/>	<input type="checkbox"/>
LAN 0-SYS-8	150	Carlos Alvarez	<input type="checkbox"/>	<input type="checkbox"/>	<input type="checkbox"/>	<input type="checkbox"/>	<input type="checkbox"/>	<input type="checkbox"/>	<input type="checkbox"/>	<input type="checkbox"/>	<input type="checkbox"/>	<input type="checkbox"/>	<input type="checkbox"/>	<input type="checkbox"/>	<input type="checkbox"/>	<input type="checkbox"/>	<input type="checkbox"/>	<input type="checkbox"/>
LAN 0-SYS-3	210	Emilia Gonzales	<input checked="" type="checkbox"/>	<input type="checkbox"/>	<input type="checkbox"/>	<input type="checkbox"/>	<input type="checkbox"/>	<input type="checkbox"/>	<input type="checkbox"/>	<input type="checkbox"/>	<input type="checkbox"/>	<input type="checkbox"/>	<input type="checkbox"/>	<input type="checkbox"/>	<input type="checkbox"/>	<input type="checkbox"/>	<input type="checkbox"/>	<input type="checkbox"/>
LAN 0-SIP-5	220	Paolo DaSilva	<input checked="" type="checkbox"/>	<input type="checkbox"/>	<input type="checkbox"/>	<input type="checkbox"/>	<input type="checkbox"/>	<input type="checkbox"/>	<input type="checkbox"/>	<input type="checkbox"/>	<input type="checkbox"/>	<input type="checkbox"/>	<input type="checkbox"/>	<input type="checkbox"/>	<input type="checkbox"/>	<input type="checkbox"/>	<input type="checkbox"/>	<input type="checkbox"/>
LAN 0-SIP-6	230	Ivan Vandenberg	<input checked="" type="checkbox"/>	<input type="checkbox"/>	<input type="checkbox"/>	<input type="checkbox"/>	<input type="checkbox"/>	<input type="checkbox"/>	<input type="checkbox"/>	<input type="checkbox"/>	<input type="checkbox"/>	<input type="checkbox"/>	<input type="checkbox"/>	<input type="checkbox"/>	<input type="checkbox"/>	<input type="checkbox"/>	<input type="checkbox"/>	<input type="checkbox"/>
LAN 0-SYS-4	240	Robert DeJoung	<input checked="" type="checkbox"/>	<input type="checkbox"/>	<input type="checkbox"/>	<input type="checkbox"/>	<input type="checkbox"/>	<input type="checkbox"/>	<input type="checkbox"/>	<input type="checkbox"/>	<input type="checkbox"/>	<input type="checkbox"/>	<input type="checkbox"/>	<input type="checkbox"/>	<input type="checkbox"/>	<input type="checkbox"/>	<input type="checkbox"/>	<input type="checkbox"/>
LAN 0-SYS-1			<input type="checkbox"/>	<input type="checkbox"/>	<input type="checkbox"/>	<input type="checkbox"/>	<input type="checkbox"/>	<input type="checkbox"/>	<input type="checkbox"/>	<input type="checkbox"/>	<input type="checkbox"/>	<input type="checkbox"/>	<input type="checkbox"/>	<input type="checkbox"/>	<input type="checkbox"/>	<input type="checkbox"/>	<input type="checkbox"/>	<input type="checkbox"/>
LAN 0-SIP-3			<input type="checkbox"/>	<input type="checkbox"/>	<input type="checkbox"/>	<input type="checkbox"/>	<input type="checkbox"/>	<input type="checkbox"/>	<input type="checkbox"/>	<input type="checkbox"/>	<input type="checkbox"/>	<input type="checkbox"/>	<input type="checkbox"/>	<input type="checkbox"/>	<input type="checkbox"/>	<input type="checkbox"/>	<input type="checkbox"/>	<input type="checkbox"/>
LAN 0-SIP-4			<input type="checkbox"/>	<input type="checkbox"/>	<input type="checkbox"/>	<input type="checkbox"/>	<input type="checkbox"/>	<input type="checkbox"/>	<input type="checkbox"/>	<input type="checkbox"/>	<input type="checkbox"/>	<input type="checkbox"/>	<input type="checkbox"/>	<input type="checkbox"/>	<input type="checkbox"/>	<input type="checkbox"/>	<input type="checkbox"/>	<input type="checkbox"/>
LAN 0-SYS-2			<input type="checkbox"/>	<input type="checkbox"/>	<input type="checkbox"/>	<input type="checkbox"/>	<input type="checkbox"/>	<input type="checkbox"/>	<input type="checkbox"/>	<input type="checkbox"/>	<input type="checkbox"/>	<input type="checkbox"/>	<input type="checkbox"/>	<input type="checkbox"/>	<input type="checkbox"/>	<input type="checkbox"/>	<input type="checkbox"/>	<input type="checkbox"/>

- Activate the user-oriented licenses in the row of the desired subscriber by selecting the appropriate check boxes.

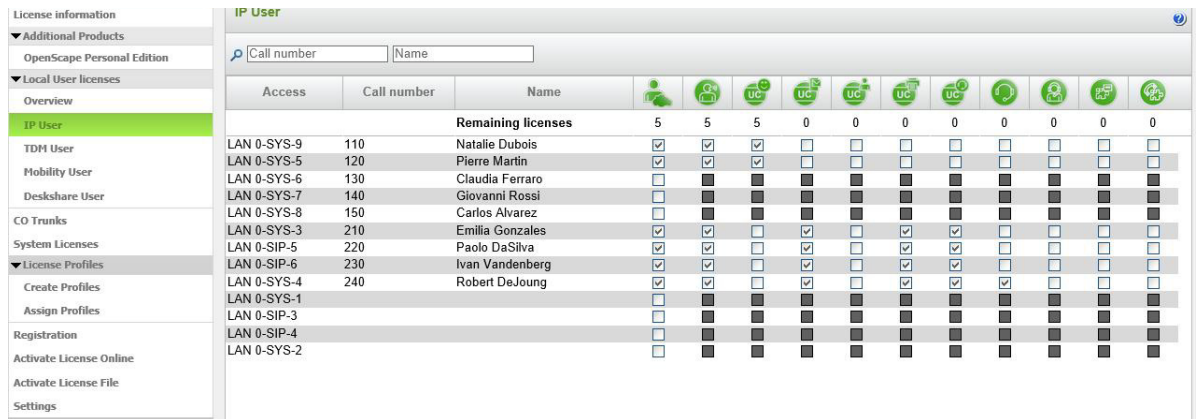

---

**INFO:** User-oriented licenses can be assigned to a subscriber only if a station license was assigned to the subscriber earlier (step 3).

---



---

**INFO:** In case of "Pay As You Go" voicemail license is checked/unchecked automatically whenever a voice user license is licensed/unlicensed but it is still possible to uncheck a voicemail license.

Groupware, UC User, Fax, myAttendant and myAgent license features are not configurable in UC Smart mode.

Groupware and UC User licenses are mutually exclusive in UC Suite mode.

myPortal Smart license feature is not configurable in UC Suite mode.

---

- 5) Click **OK & Next**. A check is performed to determine whether there are enough licenses for your assignment.

If sufficient licenses are available, this completes the licensing of the subscriber.

---

**INFO:** In case of "Pay As You Go" a pop up window appears. Click on **OK** in order to confirm your choice.

---

- 6) If licenses are missing, the errors are indicated by displaying a check box shaded in red. Correct these errors and repeat step 5.

---

**INFO:** To remove a station license, you must acknowledge a warning message. After this, a new check box **Warnings enabled** appears. If you clear this check box, you can remove further station licenses without the warning.

---

### 7.3.2.2 How to License Trunks (Standalone)

Assign the purchased trunk licenses to SIP and S<sub>2M</sub>/T1 trunks.

#### Prerequisites

- You are logged on to the WBM with the **Advanced** profile.

#### Step by Step

- 1) Click on **License Management** in the navigation bar.
- 2) In the navigation tree, click **CO trunks**. The number of licenses available for SIP and S<sub>2M</sub>/T1 trunks is displayed in the **Trunks** area.
- 3) For SIP trunks: In the **SIP trunks** area, under **License demand for number of simultaneous Internet calls in this node**, enter the number of Internet calls that can be conducted simultaneously via an ITSP.
- 4) For S<sub>2M</sub> trunks: In the **PRI (S<sub>2M</sub>/T1)** area, in the row of the desired S<sub>2M</sub> slot, select the number of desired B-channels in the drop-down list of the **Demands** column.
- 5) For digital T1 trunks (U.S. only): In the **PRI (S<sub>2M</sub>/T1)** area, in the row of the desired T1 slot, select the number of desired B-channels in the drop-down list of the **Demands** column.
- 6) For analog T1 trunks (U.S. only): Activate the analog T1 line in the **PRI (S<sub>2M</sub>/T1)** area by selecting the entry **1** (**0** means the line is disabled) in the drop-down list of the **Demands** column in the row of the analog T1 line).
- 7) Click on **OK & Next**.

---

**INFO:** The number of licensed SIP trunks and S<sub>2M</sub>/T1 trunks must not exceed the number of trunk licenses available.

---

## 7.4 Licensing Multiple Communication Systems (Internetwork)

The licensing of a multiple communication systems must be performed in a specific sequence. This sequence is shown below for a sample internetwork consisting of one OpenScape Business S (master) and two OpenScape Business X3 (slave) systems.

When multiple OpenScape Business (nodes) systems are combined into an internetwork, licensing occurs centrally via a network license file, which is activated on the master node. In addition, each slave node in the internetwork needs its own networking system license. The node with the largest bandwidth should be the master node.

The nodes in the internetwork are configured as a master node and slave nodes via the Network Wizard of the WBM. The master node contains the central license

agent (central CLA; central Customer License Agent). All slave nodes in the internetwork use this CLA for the licensing. To enable this, the IP address of the master node must be made known to the slave nodes using the WBM.

Only one network license file exists for the entire internetwork. This file is bound to the master node via the node's locking ID. If an OpenScape Business S (SoftSwitch) is the master node, the network license file is bound to the master node via either the Locking ID of the Linux server of the SoftSwitch or the Advanced Locking ID of the SoftSwitch if the SoftSwitch is used in a virtual environment. The network license file is stored in the central CLA and contains all the license information of the internetwork. It can be activated only at the master node via the WBM. Only the master node has access to the CLS; at all other nodes, the access is disabled.

No node-specific licensing should be performed in the internetwork. If separate network files exist for each node, you can combine them into a network license file at the CLS.

### **Behavior during Network Problems (Failover)**

If the connection to the master node and thus to the central CLA fails, the message "Failover Period" appears on the displays of the system telephones. During this failover period (max. 30 days), all nodes and their features continue to operate normally. Once the network problems have been resolved and the connection to the central CLA is restored, all nodes revert to the regular license status.

If the network problems cannot be resolved within the failover period, the nodes switch to operating in emergency mode. The entire internetwork will then need to be relicensed.

### **Licensing Procedure in the Internetwork Based on the Above Example**

OpenScape Business S (Master) and both OpenScape Business X3 (Slave) systems are already installed, configured and combined to form an internetwork.

#### **1. License Authorization Code (LAC)**

On purchasing licenses, the customer receives a License Authorization Code (LAC). The information on the licenses purchased are stored in the database of the Central License Server (CLS).

#### **2. OpenScape Business S as master node**

The customer or service technician logs into the WBM of the OpenScape Business S and installs the OpenScape Business S as the master node by using the Network Wizard.

For a description, see *Administrator Documentation, Networking*

The system has already been installed and configured and is running in the Activation Period (period of 30 days during which the licensing has to be completed).

#### **3. Locking ID of the master node**

The customer or service technician notes the Locking ID or the Advanced Locking ID of the OpenScape Business S.

For a description, see [How to Check the Locking ID of the Communication System](#)

**4. OpenScape Business X3 as slave nodes**

The customer or service technician first logs into the WBM of the first OpenScape Business X3 and installs the first OpenScape Business X3 as a slave node by using the Network Wizard. This process is then repeated at the WBM of the second OpenScape Business X3.

For a description, see *Administrator Documentation, Networking*

The systems have been installed and configured and are running in the Activation Period.

**5. Locking IDs of OpenScape Business X3**

The customer or service technician notes the Locking IDs of the two OpenScape Business X3 systems.

For a description, see [How to Check the Locking ID of the Communication System](#)

**6. License Activation**

The customer or service technician logs in at the CLS and generates a network license file together with the license authorization code and the locking IDs. He or she then loads this file into the master node using the WBM.

For a description, see [How to Activate Licenses Offline \(Internetwork\)](#)

The system then activates the purchased licenses.

**7. Assigning Licenses**

The customer or service technician now distributes the licenses to the nodes. To do this, he or she logs into the WBM of each node and assigns the desired number of licenses to the node. Note that it is important that each node be assigned a networking system license; otherwise, it will not be integrated into the internetwork.

For a description, see [How to Assign System Licenses to a Node](#)

## 7.4.1 License Activation (Internetwork)

After purchasing a product or feature, you must first activate the licenses provided with the product or feature. A license file is used for license activation. After successful activation of the licenses, the licenses are assigned.

Licenses can be activated as follows:

- **Offline license activation** (using the license file)

The customer or service technician logs in at the Central License Server (CLS) and enters the license authorization code there along with the Locking IDs of the communication systems. The CLS generates a license file from the data entered. The customer or service technician downloads the license file and copies it into the WBM of the master node.

The master node is checked to see whether the Locking IDs stored in the license file match those of the systems. If the check is successful, the licenses are activated, and the systems switch to the regular license status. If the check is not successful, the systems continue to run in the activation period until it expires and then only in emergency mode.

The IP address of the CLS is saved in the WBM under **License Management > Settings**.

License files can be combined as follows:



- **How to Combine License Files into a Network License File**  
If one or more nodes that have already been licensed are to be combined into an internetwork, the administrator must combine the individual license files via the CLS into a single license file and load it into the central CLA. The IP address of the master node with the central license agent must then be entered at all other nodes by using the WBM's network wizard.

### 7.4.1.1 How to Activate Licenses Offline (Internetwork)

This example describes the generation and activation of the shared network license file consisting of one OpenScape Business S as a master node (Node 1) and two further OpenScape Business X3 systems (Node 2 and Node 3).

#### **Prerequisites**

- Access to the CLS exists.
- All nodes are installed and networked with one another; see [Networking OpenScape Business X and OpenScape Business S \(Multi-Gateway\)](#).

#### **Step by Step**

- 1) Log into the CLS with your user name and password.
- 2) Under **Licenses**, select the item **Generate and download license key**.
- 3) Enter the License Authorization Code (LAC) under **LAC** and click **Search**.
- 4) Open the OpenScape Business S product and select the features to be assigned to Node 1.
- 5) Click on **Generate License Key**.
- 6) Enter the MAC address or the Advanced Locking ID of OpenScape Business S (Node 1) under **MAC Address** and then enter the MAC address or the Advanced Locking ID of OpenScape Business S of Node 1 (master node) again under **MAC Address of the Network CLA**.

---

**INFO:** The MAC address of OpenScape Business S is the MAC address of the network card of the OpenScape Business S Linux server that was used when installing the Linux operating system. The Advanced Locking ID of OpenScape Business S is used instead of the MAC address when OpenScape Business S is operated in a virtual environment.

---

- 7) Enter the desired number for the features and click **Next**.
- 8) Verify the customer data and click **Next**.
- 9) Read through the legal notification and then click **Yes, I agree to the terms of use!**.
- 10) Click on **Execute** to generate the license key.

## Licensing

### Licensing Multiple Communication Systems (Internetwork)

- 11) For Node 2, under **Licenses**, select the item **Generate and download license key**.
- 12) Enter the License Authorization Code (LAC) again under **LAC** and click **Search**.
- 13) Open the OpenScape Business X3 product and select the features to be assigned to Node 2.
- 14) Click on **Generate License Key**.
- 15) Enter the MAC address of Node 2 under **MAC Address** and then enter the MAC address of Node 1 (master node) under **MAC Address of the Network CLA**.
- 16) Enter the desired number for the features and click **Next**.
- 17) Click on **Next**.
- 18) Confirm the legal notification by selecting the check box **Yes, I agree to the terms of use!**.
- 19) Click on **Execute** to generate the license key.
- 20) Repeat steps 11 through 19 for Node 3.
- 21) Click on **License Key** and then on **Download** to download the network license file.
- 22) Save the network license file.
- 23) Log into the WBM of the master node by calling up the address `https://<IP address of the master node>` in your web browser and then entering your user name and password.
- 24) Click on **License Management** in the navigation bar.
- 25) In the navigation tree, click **Activate License File**.
- 26) Under **License File**, click **Browse** and select the storage location of the network license file.
- 27) Click on **Activate**.

#### 7.4.1.2 How to Combine License Files into a Network License File

If several nodes that were previously not networked are subsequently integrated into an internetwork, the license files of the individual nodes must be combined into a common network license file with the help of the CLS.

##### **Prerequisites**

- Access to the CLS exists, and you have the access rights for the license packages of the individual nodes.
- All nodes are installed and networked with one another; see [Networking OpenScape Business X and OpenScape Business S \(Multi-Gateway\)](#).

### **Step by Step**

- 1) Log into the CLS with your user name and password.
- 2) Under **Network Licensing**, select the item **Add/Remove System**.
- 3) Select the MAC address of the node that is to be integrated in the internetwork.
- 4) Click on the **Rehost**.
- 5) Enter the MAC address of the node under **MAC Address**.
- 6) Enter the MAC address of the master node under **MAC Address of the Network CLA**. As a rule, OpenScape Business S is the master node.

---

**INFO:** The MAC address of OpenScape Business S is the MAC address of the network card of the OpenScape Business S Linux server that was used when installing the Linux operating system.

---

- 7) Click on **Next**.
- 8) Verify the customer data and click **Next**.
- 9) Read through the legal notification and then click **Yes, I agree to the terms of use!**.
- 10) Click on **Execute** to generate the license key.
- 11) Repeat steps 2 through 10 for further nodes.
- 12) Click on **License Key** and then on **Download** to download the network license file.
- 13) Save the network license file.
- 14) Log into the WBM of the master node by calling up the address `https://<IP address of the master node>` in your web browser and then entering your user name and password.
- 15) Click on **License Management** in the navigation bar.
- 16) In the navigation tree, click **Activate License File**.
- 17) Under **License File**, click **Browse** and select the storage location of the network license file.
- 18) Click on **Activate**.

## **7.4.2 Assigning Licenses (Internetwork)**

Once the purchased licenses have been activated successfully, they must be assigned to the stations and lines. License assignment must be performed separately on each node.





### **Assigning Station Licenses and User-oriented Licenses**

Subscribers can be assigned station licenses and user-oriented licenses.

## Licensing

### Licensing Multiple Communication Systems (Internetwork)

Station licenses can be assigned to the following subscriber types:





Icon	Station license	Description
	IP stations	For the use of IP system telephones (HFA or SIP) and SIP telephones
	TDM stations	For the use of UP0 system phones, ISDN phones, analog phones and DECT phones
	Mobile stations	For the use of myPortal to go, Mobility Entry and DISA (One Number Service)
	DeskSharing stations	For the use of Desk Sharing by IP stations





The station licenses are permanently assigned to the numbers of the subscribers. If a subscriber is deleted or if another subscriber type is assigned to a call number, the associated station license is released.

With the flexible licensing, TDM, Mobility and Deskshare users can also be licensed with IP user licenses. If all the acquired TDM, DeskShare and Mobility user licenses have already been assigned to subscribers, and further TDM, DeskShare and Mobility users are required, then any remaining IP User licenses can be used to meet this demand.

After a station license has been assigned to the subscriber, a user-oriented license can also be assigned to that subscriber.

The following user-oriented licenses can be assigned to the stations:







Icon	User-oriented license	Description
	Voicemail	For the use of the voicemail box.
	UC Smart	For the use of the UC Smart features via myPortal Smart.
	Groupware user	For the use of the UC Suite features via myPortal for Outlook.
	UC Suite	For the use of the UC Suite features via myPortal for Desktop.
	Fax	For use of a fax box within the UC Suite. As a prerequisite, one UC User or Groupware User license is required.

Icon	User-oriented license	Description
	Conference	For use of the UC Suite conference features. As a prerequisite, one UC User or Groupware User license is required.
	myAttendant	For use of the UC Suite Attendant features.
	myAgent	For the use of Contact Center functions.
	Application Launcher	For call-related control of applications on a client PC during incoming and outgoing calls, e.g., launching an application or displaying caller information.
	TAPI 120/170	For the use of TAPI compliant applications and for PC-supported telephony with the customer's own applications from various software vendors.

You can have an overview of all station licenses and user-oriented licenses displayed (via **Local User Licenses > Overview**).

This overview also shows the statuses of the licenses for each subscriber.

Possible license states:

Symbol	Explanation
	Successfully licensed.
	Unsaved license release.
	Not licensed
	Unsaved license demand release.
	License demand configurable.
	Unsaved license demand.
	License demand not configurable.

### Assigning System Licenses

System licenses include licenses for trunks and for system-wide features.

Licenses can be assigned to the following types of trunks:

- S<sub>2M</sub>/T1 trunks: number of B channels
- ITSP trunks: number of simultaneous calls conducted via a single ITSP

System-wide licenses are assigned to every system (node) in the network. This configuration must be performed in direct succession (i.e., one after the other) at each node. The total number of system-wide licenses stored in the network license file on the master node is reduced by the number configured at the node.

### License assignment procedure

Prerequisite: The license file is activated and the stations are configured.

- How to License Stations
  - a) Assign a station license to a subscriber. This assignment triggers the generation of a license request for the subscriber while at the same time enabling the assignment of the user-oriented licenses.
  - b) Assign the user-oriented licenses to a subscriber. These assignments cause further license requests to be generated for the subscriber. Please note that some licenses require other licenses (see [Possible License Combinations](#)).
  - c) Check and unlock license requests.
  - d) If there are not enough licenses to be unlocked, the invalid assignments will be displayed via the license statuses (in red). Correct the license assignments and then check and unlock the licenses again.

---

**INFO:** To obtain a better overview, you can have the license assignments for all subscribers printed out as a preview (via **Local User Licenses > Overview > Print**). At the end of the printout, all invalid assignments are listed in a separate table.

---

- Assign trunk licenses  
The trunk licenses must be distributed to the required S<sub>2M</sub>/T1 and ITSP trunks.

#### 7.4.2.1 How to License Subscribers (Internetwork)

Assign the available station licenses and user-oriented licenses to the subscribers. Once the licenses have been assigned successfully, the subscribers are licensed.

##### *Prerequisites*

- You are logged on to the WBM with the **Advanced** profile.

##### *Step by Step*

- 1) Click on **License Management** in the navigation bar.
- 2) In the navigation tree, navigate to the desired type of subscriber under **Local User Licenses > ...**. You will be shown a list of all subscribers of the selected subscriber type.

Under **Remaining licenses**, you will see how many licenses you can still assign to subscribers. For TDM, Mobility and Deskshare stations, the display includes all remaining IP User licenses as well, since these licenses can also be used for the licensing of TDM, Mobility and Deskshare stations (flexible user licensing).

- 3) Activate the station license in the row of the desired subscriber by selecting the highlighted check box with a bright background (first column with check boxes). The check boxes in the other columns are enabled.

**INFO:** You can also have a selected station displayed by entering a search term in the **Station Number** or **Name** search fields and then pressing the Enter key or clicking the magnifying glass icon. All stations will be listed if you leave both search fields empty and then press the Return key or click on the magnifying glass icon.

The screenshot shows the 'IP User' section of the license management interface. On the left is a navigation menu with options like 'License information', 'Additional Products', 'Local User licenses', and 'License Profiles'. The main area displays a table with columns for 'Access', 'Call number', 'Name', and a series of license status indicators. The 'Remaining licenses' row shows counts for various systems: 5, 5, 5, 0, 0, 0, 0, 0, 0, 0. The table lists subscribers such as Natalie Dubois (LAN 0-SYS-9), Pierre Martin (LAN 0-SYS-5), Claudia Ferraro (LAN 0-SYS-6), Giovanni Rossi (LAN 0-SYS-7), Carlos Alvarez (LAN 0-SYS-8), Emilia Gonzales (LAN 0-SYS-3), Paolo DaSilva (LAN 0-SIP-5), Ivan Vandenberg (LAN 0-SIP-6), and Robert DeJoung (LAN 0-SYS-4). Each row has a check box in the first license column, which is highlighted in green, and other license columns with smaller, dimmed check boxes.

- 4) Activate the user-oriented licenses in the row of the desired subscriber by selecting the appropriate check boxes.

This screenshot is similar to the previous one but shows the 'user-oriented licenses' step. In the table, the check boxes in the first license column for each subscriber are now checked. Additionally, check boxes in other license columns are also checked for several subscribers, indicating that user-oriented licenses are being assigned. For example, for Natalie Dubois, the first and second license columns are checked. For Pierre Martin, the first, second, and third license columns are checked. For Claudia Ferraro, the first, second, and third license columns are checked. For Giovanni Rossi, the first, second, and third license columns are checked. For Carlos Alvarez, the first, second, and third license columns are checked. For Emilia Gonzales, the first, second, and third license columns are checked. For Paolo DaSilva, the first, second, and third license columns are checked. For Ivan Vandenberg, the first, second, and third license columns are checked. For Robert DeJoung, the first, second, and third license columns are checked.

**INFO:** User-oriented licenses can be assigned to a subscriber only if a station license was assigned to the subscriber earlier (step 3).

## Licensing

### Licensing Multiple Communication Systems (Internetwork)

---

**INFO:** "Pay As You Go" is not available in case of network license file.

In case of a network of OpenScope Business systems, any of the systems can utilize Pay As You Go via local Central License Agent (CLA).

---

- 5) Click **OK & Next**. A check is performed to determine whether there are enough licenses for your assignment.

If sufficient licenses are available, this completes the licensing of the subscriber.

- 6) If licenses are missing, the errors are indicated by displaying a check box shaded in red. Correct these errors and repeat step 5.

---

**INFO:** To remove a station license, you must acknowledge a warning message. After this, a new check box **Warnings enabled** appears. If you clear this check box, you can remove further station licenses without the warning.

---

#### 7.4.2.2 How to License Trunks (Internetwork)

Assign the purchased trunk licenses to SIP and S<sub>2M</sub>/T1 trunks.

##### **Prerequisites**

- You are logged on to the WBM with the **Advanced** profile.

##### **Step by Step**

- 1) Click on **License Management** in the navigation bar.
- 2) In the navigation tree, click **CO trunks**. The number of licenses available for SIP and S<sub>2M</sub>/T1 trunks is displayed in the **Trunks** area.
- 3) For SIP trunks: In the **SIP trunks** area, under **License demand for number of simultaneous Internet calls in this node**, enter the number of Internet calls that can be conducted simultaneously via an ITSP.
- 4) For S<sub>2M</sub> trunks: In the **S2M** area, in the row of the desired slot, select the number of desired B-channels in the drop-down list of the **Demands** column.
- 5) For T1 trunks (only for the U.S.): In the **T1** area, in the row of the desired slot, select the number of desired B-channels in the drop-down list of the **Demands** column.
- 6) Click on **OK & Next**.



---

**INFO:** The number of licensed SIP trunks and S<sub>2M</sub>/T1 trunks must not exceed the number of trunk licenses available.

---

### 7.4.2.3 How to Assign System Licenses to a Node

#### *Prerequisites*

- You are logged on to the WBM of the desired node.

#### *Step by Step*

- 1) Click on **License Management** in the navigation bar.
- 2) Click on **System Licenses** in the navigation tree. All available system licenses are displayed.
- 3) Locate the desired system licenses in the **used licenses** column and select the number of system licenses to be assigned to the node.

The **available for distribution** column indicates how many licenses are available for the entire internetwork.

---

**INFO:** Make sure that the node is assigned the "Networking" system license, otherwise the node will fail to be integrated into the internetwork.

---

- 4) Click on **Save**.

### 7.4.2.4 How to Assign the "Networking" System License to a Node

#### *Prerequisites*

- You are logged on to the WBM of the desired node.

#### *Step by Step*

- 1) Click on **License Management** in the navigation bar.
- 2) Click on **System Licenses** in the navigation tree. All available system licenses are displayed.
- 3) For the **Networking** system license, select **1** from the drop-down list in the **used licenses** column.

The **available for distribution** column indicates how many licenses are available for the entire internetwork.

- 4) Click on **Save**.

## 7.5 License information

Information on the available and assigned licenses, products and features is displayed with the WBM. The license information on all nodes available in the internetwork can be retrieved.

The following information can be displayed:

- **MAC Address:** MAC address of the hardware platform or the Linux Server SoftSwitch to which the licenses are bound.

---

**INFO:** If the communication system is in the activation period, a wrong MAC address may possibly be shown here. The correct MAC address can be checked via the Service Center under Inventory ([Inventory](#)).

---

- **Advanced Locking ID:** Advanced Locking ID of the softswitches in a virtual environment, to which the licenses are bound.
- **Locking ID:** Locking ID of the Application Server to which the licenses are bound.
- **Node:** Name of the communication system to which the license is bound.
- **Product Name:** Name of the product for which the license is assigned.
- **Feature:** Feature for which the license has been assigned.
- **Used licenses:** Shows the number of used and available licenses.
- **Available for distribution:** Shows the licenses still available in the internetwork.
- **Status:** Status of the license.

The OpenScape Personal Edition and OpenScape Business Accounting products are licensed by their own license files. The license information for these are displayed under **Additional Products**.

### 7.5.1 License Information without a Network (Standalone)

All licenses assigned to the communication system and the relevant licensing information can be displayed.

#### 7.5.1.1 How to Display License Information

##### *Prerequisites*

- You are logged in at the WBM.

##### *Step by Step*

- › Click on **License Management** in the navigation bar. The license information for your communication system will be displayed.

License Management				
License information				
Local User licenses				
CO Trunks				
System Licenses				
License Profiles				
Create Profiles				
Assign Profiles				
Registration				
Activate License Online				
Activate License File				
Settings				
System Licenses				
Product Name	Feature	used licenses	available for distribution	
OpenScape Business V1	OpenScape Business V1 Xpr Compact Announcement	24	24	
OpenScape Business V1	OpenScape Business V1 Xpr Compact Conferencing	3	3	
OpenScape Business V1	OpenScape Business V1 Xpr Compact Mobility	6	6	
OpenScape Business V1	OpenScape Business V1 OpenDirectory Connector	4	4	
OpenScape Business V1	OpenScape Business V1 OpenDirectory Base	1	1	
OpenScape Business V1	OpenScape Business V1 optiClient Attendant	8	8	
OpenScape Business V1	OpenScape Business V1 Networking	1	1	
OpenScape Business V1	OpenScape Business V1 Web Collaboration	1	1	
OpenScape Business V1	OpenScape Business V1 Company Autoattendant	1	1	
OpenScape Business V1	OpenScape Business V1 Contact Center Fax	1	1	
OpenScape Business V1	OpenScape Business V1 Contact Center E-Mail	1	1	
OpenScape Business V1	OpenScape Business V1 myReports	1	1	
OpenScape Business V1	OpenScape Business V1 Gate View Cameras	8	8	

---

**INFO:** In case of "Pay As You Go" used licenses are configurable except for Contact Center Fax, Contact Center E-mail and myReports in UC Smart mode.

---

## 7.5.2 License Information in an Internetwork

In an internetwork, all existing licenses and the relevant license information can be displayed. This information is read from the network license file.

All licenses of an internetwork (with the exception of the base licenses) are "floating" licenses and are managed in a license pool. If a license is no longer required by a node (communication system), it is released and can thus be used another node.

All the licenses of the internetwork as well as any shared (floating) licenses or licenses that are bound to a specific node can be displayed in an internetwork.

In addition, station licenses and user-oriented licenses can be sorted by node and displayed in a list.

### 7.5.2.1 How to Display all Licenses in the Internetwork

#### Prerequisites

- The communication system is located in an internetwork.
- You are logged in at the WBM.

#### Step by Step

- 1) Click on **License Management** in the navigation bar.
- 2) In the navigation tree, click on **License Information**. All licenses in the internetwork are displayed.

## Licensing

### License information

License Information				
Licenses with Locking ID: 001AE85DEB35				
	Product Name	Feature	used licenses	Status
1	OpenScape Business V1	Java Husim Phonetester	0 of 5	valid
2	OpenScape Business V1	OpenScape Business V1 Application Launcher	0 of 10	valid
3	OpenScape Business V1	OpenScape Business V1 Base	1 of 2	valid
4	OpenScape Business V1	OpenScape Business V1 Company Autoattendant	2 of 2	valid
5	OpenScape Business V1	OpenScape Business V1 Conference	15 of 15	valid
6	OpenScape Business V1	OpenScape Business V1 Contact Center E-Mail	2 of 2	valid
7	OpenScape Business V1	OpenScape Business V1 Contact Center Fax	2 of 2	valid
8	OpenScape Business V1	OpenScape Business V1 Deskshare User	0 of 15	valid
9	OpenScape Business V1	OpenScape Business V1 Fax	10 of 10	valid
10	OpenScape Business V1	OpenScape Business V1 Gate View Cameras	1 of 1	valid
11	OpenScape Business V1	OpenScape Business V1 Groupware User	15 of 15	valid
12	OpenScape Business V1	OpenScape Business V1 IP User	20 of 35	valid
13	OpenScape Business V1	OpenScape Business V1 Mobility User	0 of 15	valid

### 7.5.2.2 How to Display the Licenses Bound to a Node

#### Prerequisites

- The communication system is located in an internetwork.
- You are logged in at the WBM.

#### Step by Step

- 1) Click on **License Management** in the navigation bar.
- 2) In the navigation tree, click on **License Information**.
- 3) Click in the navigation tree on the system name or the locking ID of the desired node. The licenses specifically bound to this node will be displayed, e.g., the base license.

License information				
List of Licenses for MAC Address: 00-1A-EB-5D-EB-35				
	Product Name	Feature	available for distribution	Status
1	OpenScape Business V1	OpenScape Business V1 Base	1	valid

### 7.5.2.3 How to Display all Shared Licenses in an Internetwork

#### Prerequisites

- The communication system is located in an internetwork.
- You are logged in at the WBM.

#### Step by Step

- 1) Click on **License Management** in the navigation bar.
- 2) In the navigation tree, click on **License Information**.

- 3) In the navigation tree, click **Floating**. All shared licenses in the internetwork are displayed.

License Management				
License information				
Licenses with Locking ID: 001AE85DEB35				
	Product Name	Feature	available for distribution	Status
1	OpenScape Business V1	Java Husim Phonetester	5	valid
2	OpenScape Business V1	OpenScape Business V1 Application Launcher	10	valid
4	OpenScape Business V1	OpenScape Business V1 Company Autoattendant	2	valid
5	OpenScape Business V1	OpenScape Business V1 Conference	15	valid
6	OpenScape Business V1	OpenScape Business V1 Contact Center E-Mail	2	valid
7	OpenScape Business V1	OpenScape Business V1 Contact Center Fax	2	valid
8	OpenScape Business V1	OpenScape Business V1 Deskshare User	15	valid
9	OpenScape Business V1	OpenScape Business V1 Fax	10	valid
10	OpenScape Business V1	OpenScape Business V1 Gate View Cameras	1	valid
11	OpenScape Business V1	OpenScape Business V1 Groupware User	15	valid
12	OpenScape Business V1	OpenScape Business V1 IP User	35	valid
13	OpenScape Business V1	OpenScape Business V1 Mobility User	15	valid
14	OpenScape Business V1	OpenScape Business V1 myAgent	12	valid
15	OpenScape Business V1	OpenScape Business V1 myAttendant	2	valid
16	OpenScape Business V1	OpenScape Business V1 myPortal Smart	15	valid
17	OpenScape Business V1	OpenScape Business V1 myReports	2	valid
18	OpenScape Business V1	OpenScape Business V1 Networking	2	valid
19	OpenScape Business V1	OpenScape Business V1 OpenDirectory Base	2	valid
20	OpenScape Business V1	OpenScape Business V1 OpenDirectory Connector	3	valid

## 7.5.2.4 How to Display a Node-Dependent View of Station Licenses and User-Oriented Licenses

### Prerequisites

- The communication system is located in an internetwork.
- You are logged in at the WBM.

### Step by Step

- 1) Click on **License Management** in the navigation bar.
- 2) Click on **Network-wide License Overview** in the navigation tree. All station licenses and user-oriented licenses in the internetwork can be sorted by node.

## 7.6 Assigning License Profiles

License profiles contain predefined license assignments and can be assigned to one or more stations. License profiles are useful if more than one subscriber is to receive same license.

You can use predefined license profiles or create new license profiles.

A license profile only applies to one station type and can only be assigned to stations of this type. Several license profiles can be created and named appropriately for a station type.

License profiles can be created for the following types of stations:

- IP stations (IP system phones, SIP phones)
- TDM stations (UP0 phones, ISDN phones, analog phones, DECT phones)

- DeskSharing stations
- Mobile stations

Within a license profile, you can assign user-oriented licenses to the station type as needed.

If the license assignment for a station within a license profile is changed, the assignment of the station to the license profile is automatically revoked.

## 7.6.1 How to Add a License Profile

Create a new license profile.

### Prerequisites

- You are logged on to the WBM with the **Advanced** profile.

### Step by Step

- 1) Click on **License Management** in the navigation bar.
- 2) Click in the navigation tree on **License Profiles > Create Profiles**. All existing license profiles are displayed.

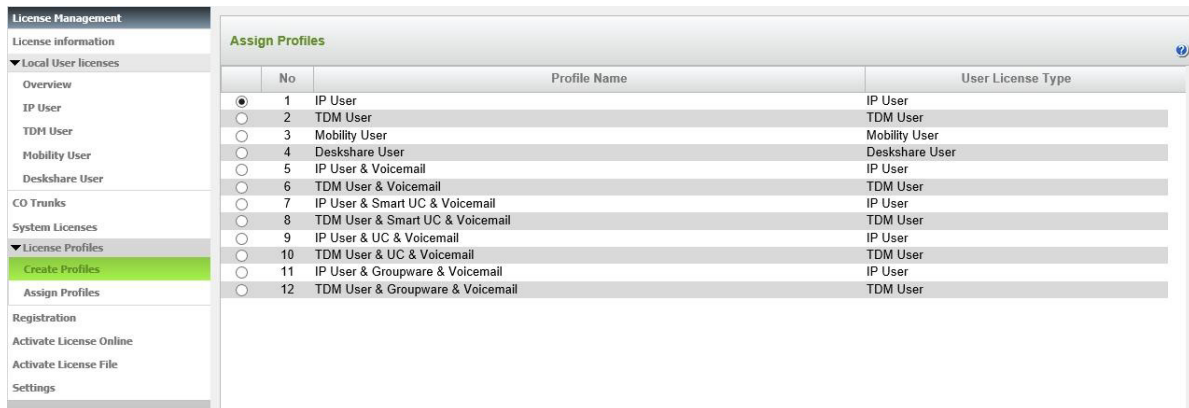

- 3) Click on **Add**.

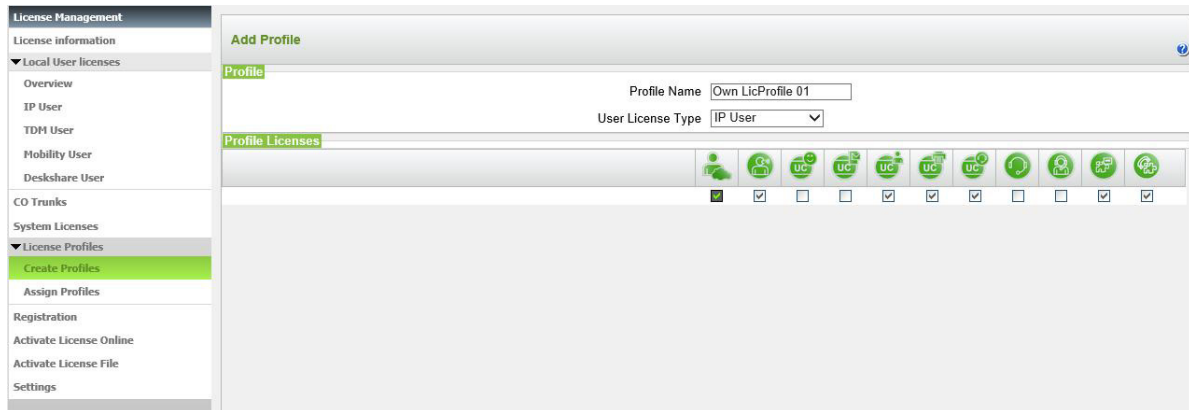

- 4) In the **Profile Name** field, enter a name of your choice for the new profile.

- 5) Select the subscriber type to which the profile is to be applied from the **User License Type** drop-down list.
- 6) Select the user-oriented licenses by activating the appropriate check boxes.
- 7) Click on **OK & Next**. A check is performed to see whether the licenses are assigned correctly.  
  
If all licenses are assigned correctly, the licensing of subscribers is considered to be complete.
- 8) If any of the licenses are assigned incorrectly, their check boxes will be shaded in red. Correct these errors and repeat step 7.

## 7.6.2 How to Edit a License Profile

Edit an existing license profile.

### Prerequisites

- You are logged on to the WBM with the **Advanced** profile.

### Step by Step

- 1) Click on **License Management** in the navigation bar.
- 2) Click in the navigation tree on **License Profiles > Create Profiles**. All existing license profiles are displayed.

No	Profile Name	User License Type
<input checked="" type="radio"/>	1 IP User	IP User
<input type="radio"/>	2 TDM User	TDM User
<input type="radio"/>	3 Mobility User	Mobility User
<input type="radio"/>	4 Deskshare User	Deskshare User
<input type="radio"/>	5 IP User & Voicemail	IP User
<input type="radio"/>	6 TDM User & Voicemail	TDM User
<input type="radio"/>	7 IP User & Smart UC & Voicemail	IP User
<input type="radio"/>	8 TDM User & Smart UC & Voicemail	TDM User
<input type="radio"/>	9 IP User & UC & Voicemail	IP User
<input type="radio"/>	10 TDM User & UC & Voicemail	TDM User
<input type="radio"/>	11 IP User & Groupware & Voicemail	IP User
<input type="radio"/>	12 TDM User & Groupware & Voicemail	TDM User

- 3) Activate the radio button in front of the desired license profile and click **Edit**.

**Licensing**  
Assigning License Profiles

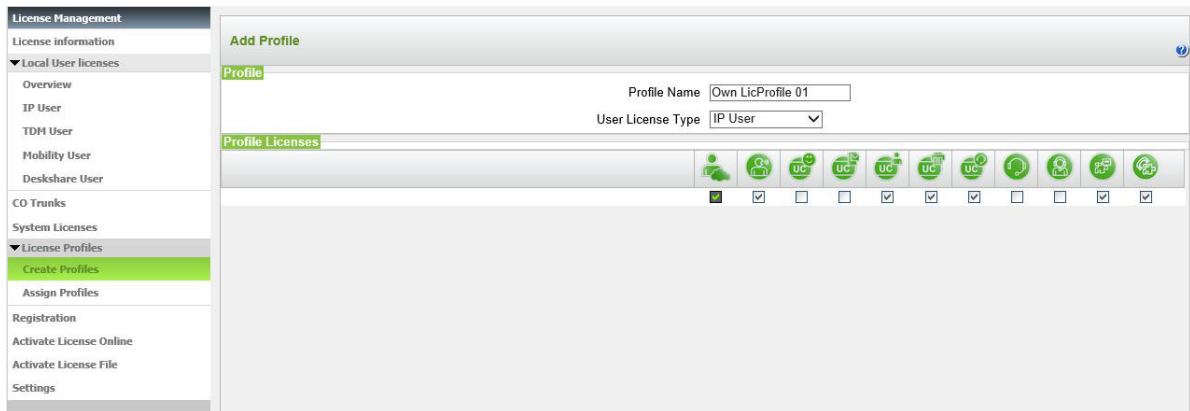

- 4) Edit the license profile as desired.
- 5) Click on **OK & Next**. A check is performed to see whether the licenses are assigned correctly.  
If all licenses are assigned correctly, license profile editing is complete.
- 6) If any of the licenses are assigned incorrectly, their check boxes will be shaded in red. Correct these errors and repeat step 5.

### 7.6.3 How to Assign a License Profile to Stations

Assign a license profile to the available stations.

**Prerequisites**

- You are logged on to the WBM with the **Advanced** profile.

**Step by Step**

- 1) Click on **License Management** in the navigation bar.
- 2) Click in the navigation tree on **License Profiles > Assign Profiles**. All existing license profiles are displayed.

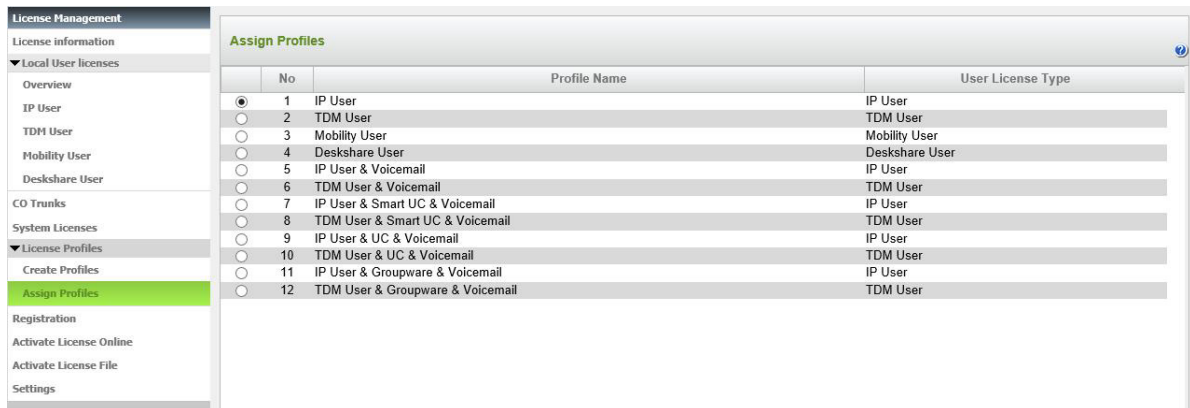

- 3) Activate the radio button in front of the desired license profile and click **OK & Next**.





- 4) Under **Selection** on the left, select all stations to which the license profile is to be assigned.
- 5) Click on **Add**. The selected stations appear in the **Members** window on the right.
- 6) Click on **OK & Next**. The licenses selected in the license profile are assigned to the stations.

---

**INFO:** In case of "Pay As You Go" a pop up window appears. Click on **OK** in order to confirm your choice.

---



---

**INFO:** Stations can also be removed from a license profile or added to it later.

---

## 7.6.4 How to Delete a License Profile

Delete an existing license profile.

### Prerequisites

- You are logged on to the WBM with the **Advanced** profile.

### Step by Step

- 1) Click on **License Management** in the navigation bar.
- 2) Click in the navigation tree on **License PrProfilesofile > Create Profiles**. All existing license profiles are displayed.

## Licensing

### Rehosting after Replacement of Hardware

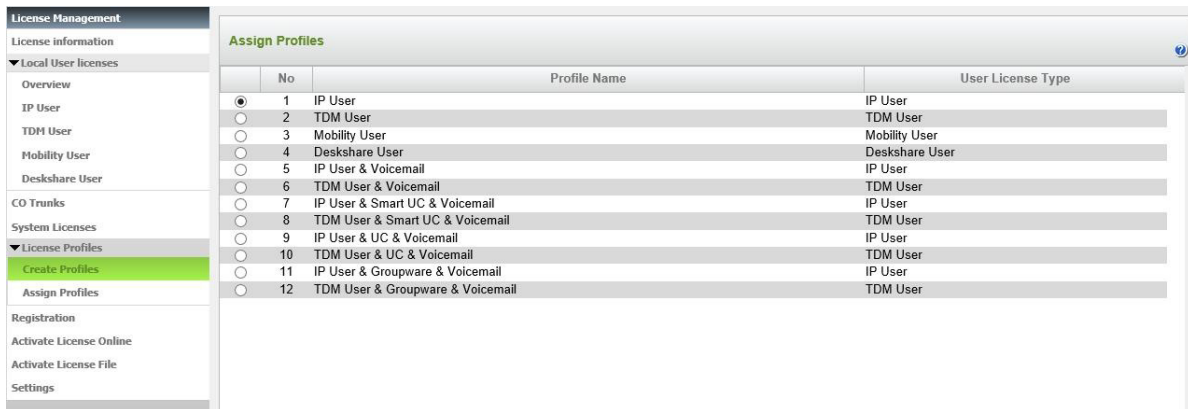

- 3) Activate the radio button in front of the desired license profile and click **Delete**.
- 4) Confirm the message with **OK**. The license profile is deleted.

## 7.7 Rehosting after Replacement of Hardware

Licenses must be updated whenever the mainboard of the hardware platform or the network card of the Linux server is replaced at the communication system. Rehosting requires the MAC address of the old hardware, the MAC address of the new hardware and the login credentials for the central license server (CLS).

After replacing the hardware, the configuration data must be restored using the latest backup set (see [Restore](#)).

Since the licenses are bound to the MAC address of the hardware, the MAC address changes on replacing the hardware, and the licenses are thus no longer valid. After a hardware replacement, the communication system reverts to the activation period. After the old and new MAC addresses have been entered at the CLS, the new license file can be generated. This is loaded into the communication system through via an offline update, and all existing licenses are then activated automatically.

For the softswitch, the MAC address of the network card of the Linux server, which was selected on installing the Linux operating system (visible via YaST), is used. The MAC address can also be read by using the WBM.

---

**INFO:** Every rehost is logged on the CLS. A license can be used for a rehost up to three times.

---

---

**INFO:** The IP address of the CLS can be checked via the WBM under **License Management > Settings** and changed if required.

---

## 7.7.1 How to Perform a Rehost after Replacing Hardware

### *Prerequisites*

- You are logged on to the WBM with the **Advanced** profile.
- The hardware has been replaced, and you have performed a rehost at the CLS.
- The configuration data has been restored using the latest backup set.
- You know the License Authorization Code (LAC) needed to release the license.
- In order to access the License server, the communication system must have access to the Internet.

### *Step by Step*

- 1) Click on **License Management** in the navigation bar.
- 2) In the navigation tree, click **Activate License Online**.
- 3) Enter the appropriate LAC in the **License Authorization Code (LAC)** field.
- 4) Leave the check boxes for accessing the License server via a user name and password disabled. Access to the Licensing Server occurs automatically. (The input of a user name and password is only required for sales partners.)
- 5) Click on **Activate**. The connection to the license server is established and the licenses are released. Following the successful update, the connection is reestablished automatically.
- 6) Restart the communication system.

### *Next steps*

Save your configuration data in a new backup set (see [Immediate Backup](#)).

## 7.8 License Server (Central License Server, CLS)

The Central License Server (CLS) generates and manages the license files.

A license file is generated when the customer sends the License Authorization Code (LAC) to the CLS via the WBM. The transmission of the license file to the communication system occurs automatically via the Internet. If an automatic transmission is not possible, the license file can also be loaded manually into the communication system.

## 7.8.1 How to Check or Change the IP Address of the License Server

### *Prerequisites*

- You are logged on to the WBM with the **Advanced** profile.
- If the IP address of the Central License Server has changed, you will need to know the current IP address.

### *Step by Step*

- 1) Click on **License Management** in the navigation bar.
- 2) In the navigation tree, click on **Settings**. The IP address of the Central License Server (CLS) appears in the **IP address of the Central License Server** field. The currently valid IP address is 188.64.16.4.
- 3) If you need to change the IP address of the Central License Server, enter the new IP address of the Central License Server in the corresponding **IP address of the Central License Server** field in the format 123.124.125.126.
- 4) Click on **Activate**.

## 7.9 Customer License Agent (CLA)

The Customer License Agent (CLA) is part of the OpenScape Business communication software and runs automatically in the background. It manages the license file and the licenses contained therein. The CLA checks the license requirements, and if sufficient licenses are available, it activates the licenses. There is only one CLA (local CLA) for each communication system. If several communication systems (nodes) are present in one internetwork, only one CLA (central CLA) should be used on the master node.

The following configurations are possible:

- **How to Configure the Connection to the Local License Agent**  
When a node is removed from the internetwork, the connection to the central CLA will be cleared. The local CLA installed on the node is used automatically instead. If this automatic mechanism fails, the connection to the local CLA can also be made manually.
- **How to Change the Connection to the Central License Agent**  
Every node in the internetwork requires the connection to the Central CLA on the master node. This connection is automatically established on running the WBM wizard **Network**. If the IP address of the master node changes, the connection to the central CLA must be reconfigured at all slave nodes.

## 7.9.1 How to Configure the Connection to the Local License Agent

### *Prerequisites*

- You are logged on to the WBM of the desired node.

### *Step by Step*

- 1) Click on **License Management** in the navigation bar.
- 2) In the navigation tree, click on **Settings**.
- 3) Enable the **Customer License Agent (CLA) Local Host** radio button.
- 4) Click on **Activate**.

## 7.9.2 How to Change the Connection to the Central License Agent

### *Prerequisites*

- The communication system is located in an internetwork.
- You are logged on to the WBM of the desired node.

### *Step by Step*

- 1) Click on **License Management** in the navigation bar.
- 2) In the navigation tree, click on **Settings**.
- 3) Enable the **Central License Agent** radio button and enter the IP address of the master node (node 1) under **IP address of Central License Agent** in the format 123.124.125.126.
- 4) Click on **Activate**.

## 7.10 Locking ID and Advanced ID Locking

Each communication system is assigned a Locking ID or an Advanced Locking ID. To ensure a unique assignment of licenses, the licenses are tied to these Locking IDs.

### **Locking ID**

With hardware platforms, the Locking ID is the MAC address of the communication system.

With softswitches, the Locking ID is the MAC address of the network card of the Linux server. If the Linux server has multiple network cards, the network card that was used at initial startup of the Linux server must be selected.

If the communication system is in the activation period, a wrong MAC address may possibly be shown under the license information. The correct MAC address can be checked via the **Service Center** under **Inventory**.

#### Advanced Locking ID

If a softswitch runs in a virtual environment, the Advanced Locking ID (ALI) is used instead of the Locking ID. The Advanced Locking ID is generated at the CLS using the ALI Calculator.

The following system and network parameters must be configured, since they are used to generate the 24-digit Advanced Locking ID.

- IP address of the default gateway (Linux server)
- Host name of the Linux server
- IP address of the Linux server
- IP address of the DNS server (configured in the Linux server)
- Time zone (Linux server)

If one or more of these system and network parameters are not set, then the Advanced Locking ID cannot be generated.

The Advanced Locking ID is displayed in the WBM. In some cases, it is possible that the ALI which was generated at the CLS for the license file may differ from the ALI which is displayed during the activation period in the WBM. The license file containing the deviant ALI is accepted by the system anyway.

If any of the system and network parameters listed above changes, the softswitch reverts to the unlicensed state, and a new Advanced Locking ID is generated. In order to be able to use the purchased license again, a rehost from the old to the new Advanced Locking ID must be conducted at the Central License Server (CLS).

If the system detects a change in ALI, a message is displayed on the WBM home page in Licensing area to inform the user that ALI has been changed. The user has to click on Confirm, to verify for being informed about the change. Then the message is removed from the WBM home page, until a new instance of ALI change is detected. If the user does not click on Confirm, the message is permanently displayed on the home page.

---

**IMPORTANT:** If a user presses the confirm button, no email will be sent afterwards. An email will only be sent if the user hasn't confirmed the changes via Home page. Email mechanism is triggered every day with an 24h interval, starting from the last system restart.

---

## 7.10.1 How to Check the Locking ID of the Communication System

### *Prerequisites*

- You are logged on to the WBM with the **Advanced** profile.

**Step by Step**

- 1) Click on **Service Center** in the navigation bar.
- 2) In the navigation tree, click **Inventory**. An overview of the components that make up the communication system is shown.
- 3) Click on **OK & Next**. Information on the hardware and software appears. The locking ID of the communication system can be found under **MAC ID for license**.

## 7.10.2 How to Check the Locking ID of the Softswitch

**Prerequisites**

- You are logged on to the WBM with the **Advanced** profile.

**Step by Step**

- 1) Click on **Service Center** in the navigation bar.
- 2) In the navigation tree, click **Inventory**. Information on the software of the softswitches, the available and used hard disk storage and on the application status will be displayed. The locking ID of the softswitch can be found under **MAC ID for license**.

## 7.10.3 How to Check the Advanced Locking ID of Softswitches

**Prerequisites**

- You are logged on to the WBM with the **Advanced** profile.

**Step by Step**

- › Click on **License Management** in the navigation bar. All existing licenses are displayed. If the softswitch is being operated in a virtualized environment, the advanced locking ID of the softswitch can be found under **Locking ID**.

## 8 Integration into the Internal Data Network (LAN)

The integration of the communication system in the existing internal network (LAN) enables the use of UC solutions and the administration of the communication system on PCs in the internal network.

The following network parameters must be set up in the WBM:

- OpenScape Business X hardware platform: IP address and network mask of the mainboard and the UC Booster Card (if present). These settings are made during the initial installation, but can be changed later.  
Softswitch OpenScape Business S: IP address and subnet mask of the Linux server on which the communication software is running. These settings are made during the Linux installation, but can be changed later.
- The communication system can be optionally set up as a DHCP server (supplied with network-specific parameters such as the subnet mask, default gateway, DNS server) or as a DHCP relay agent. The setup as a DHCP server is performed during the initial installation, but can be changed later. The setup as a DHCP relay agent is performed in Expert mode.
- IP address of the default router and the (external) DNS server for access to other IP networks (e.g., the Internet). These settings are made during the initial installation, but can be changed later.

### 8.1 LAN Interface

In order to integrate the communication system in the LAN infrastructure, the IP address and internal IP address range of the communication system must be adapted to the IP address scheme of the internal network (LAN).

#### 8.1.1 IP Address and Subnet Mask of the LAN Interface

The IP address and the subnet netmask of the communication system are defined during the initial installation but can also be changed later. You may need to adapt the IP address and/or subnet mask to the IP address range of the LAN.

##### Hardware Platform

By default, the hardware platform is assigned an IP address and a subnet mask. The UC Booster Card also requires an IP address. The IP address of the UC Booster Card can be configured regardless of whether the UC Booster Card is installed or not.

The hardware platform uses the "LAN" interface of the mainboard for integration into the LAN. Whenever the UC Booster Card is installed, the "LAN" interface of the UC Booster Card must also be connected to the LAN. The hardware platform and UC Booster Card must be located in the same subnet.



To activate the changes to the IP address or subnet mask, a restart of the hardware platform is required.

The changes to the IP address and the subnet mask remain in effect after a software update, but will be reset to the default values in the event of a hardware platform reload. These changes cannot be stored in a backup set.

### Softswitch

For a softswitch, the Linux server on which the communication software runs is integrated into the LAN via its network card.

The change of IP address or subnet mask takes effect after a restart of the application (see [Restart](#), [Reload](#), [Shutdown](#)).

## 8.1.1.1 How to Change the IP Address and Subnet Mask of the Hardware Platform

### Prerequisites

- You are logged on to the WBM with the **Advanced** profile.

### Step by Step

- In the navigation bar, click on **Setup**.
- Click on **Edit** to start the **Initial Installation** wizard.

The screenshot shows the 'System Settings' window. It contains several input fields for configuration. A red box highlights the 'OpenScape Office - IP address' field (containing '192.168.1.2') and the 'OpenScape Office - Netmask' field (containing '255.255.255.0'). Other fields include 'Display Logo' (OpenScape Biz), 'Brand' (OpenScape Business), 'Application board - IP address' (192.168.1.3), and 'Application board - Netmask' (255.255.255.0).

- Under **OpenScape Business - IP Address**, edit the IP address of the hardware platform. The IP address must conform to the IP address scheme of the internal network and must not have been assigned to any network client, since this would otherwise result in an IP address conflict. By default, the IP address 192.168.1.2 is entered here.
- Under **OpenScape Business - Netmask**, edit the subnet mask of the hardware platform. The subnet mask must match the IP address scheme of the internal network. By default, the subnet mask will have been entered as 255.255.255.0.
- Click on **OK & Next**.
- Keep clicking **OK & Next** until you receive a message that the feature has been installed.
- Click on **Finish**. The hardware platform automatically performs a restart.

## 8.1.1.2 How to Change the IP Address of the UC Booster Card

### Prerequisites

- You are logged on to the WBM with the **Advanced** profile.

### Step by Step

- 1) In the navigation bar, click on **Setup**.
- 2) Click on **Edit** to start the **Initial Installation** wizard.

The screenshot shows the 'System Settings' configuration page. It contains several input fields for network settings. The 'Application board - IP address' field is highlighted with a red rectangular box. The other fields are: 'Display Logo' (OpenScape Biz), 'Brand' (OpenScape Business), 'OpenScape Office - IP address' (192.168.1.2), 'OpenScape Office - Netmask' (255.255.255.0), and 'Application board - Netmask' (255.255.255.0).

- 3) Under **UC Booster Card - IP Address**, edit the IP address of the UC Booster Card. The IP address must conform to the IP address scheme of the internal network and must not have been assigned to any network client, since this would otherwise result in an IP address conflict. By default, the IP address 192.168.1.3 is entered here.
- 4) Click on **OK & Next**.
- 5) Keep clicking **OK & Next** until you receive a message that the feature has been installed.
- 6) Click on **Finish**. The hardware platform automatically performs a restart.

## 8.1.1.3 How to Check or Change the IP Address and Subnet Mask of the Softswitch

### Step by Step

- 1) Click on **Computer** in the task bar.
- 2) In the menu tree, click on **System > YaST**.
- 3) Enter the password for the root user and click **Continue**. The YaST Control Center is opened.
- 4) Click on **Network Devices** in the menu tree.
- 5) In the **Network Devices** area, click on **Network Settings**.
- 6) Select the desired network card in the **Overview** window and click on **Edit**.
- 7) Enable the radio button **Statically assigned IP Address**.
- 8) Under **IP Address**, change the IP address of the Linux server on which the software of the softswitch is running. The IP address must conform to the IP address scheme of the internal network and must not have been assigned to any network client, since this would otherwise result in an IP address conflict.

- 9) Under **Subnet mask**, edit the subnet mask of the Linux server. The subnet mask must conform to the IP address scheme of the internal network.
- 10) Click on **Next** followed by **OK**.
- 11) Close the **YaST Control Center**.

## 8.1.2 Internal IP Address Range of the LAN Interface

The internal IP address range of the LAN interface that is used by the hardware platform for the internal communication of its modules can be changed if necessary.

The hardware platform uses the internal IP address range 192.168.3.xxx by default. This address range can also be edited and set to a desired IP address range. The internal subnet mask is 255.255.255.0 and cannot be changed.

To activate the changes to the internal IP address range, a restart of the hardware platform is required.

The changes to the internal IP address range remain in effect with a software update, but will be reset to the default values in the event of a reload. These changes cannot be stored in a backup set.

### 8.1.2.1 How to Change the Internal IP Address Range of the Hardware Platform

#### Prerequisites

- You are logged into the WBM with the **Expert** profile.

#### Step by Step

- 1) In the navigation bar, click on **Expert Mode**.
- 2) In the navigation tree, click **Telephony > Payload**.
- 3) Click **Hardware Modules** in the menu tree.
- 4) Click on the **Edit DSP Settings** tab.

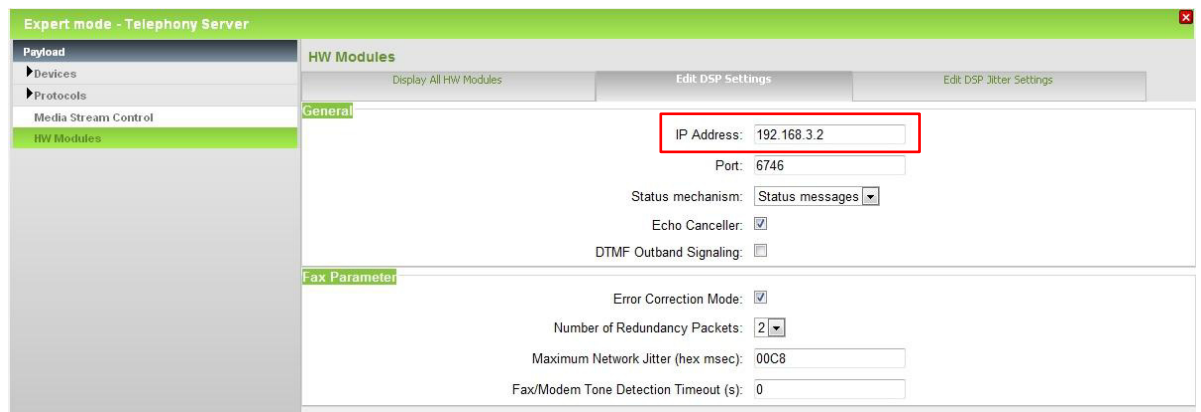

## Integration into the Internal Data Network (LAN)

### DHCP

- 5) In the **General** area under **IP address**, enter an IP address for the communication system that is in the desired new internal range, e.g., 192.168.40.2. The entire IP address range (in this example 192.168.40.xxx) is now blocked for other clients on the LAN.
- 6) Click on **Apply** and confirm with **OK**.

### 8.1.2.2 How to Reset the Internal IP Address Range of the Hardware Platform

#### Prerequisites

- You are logged into the WBM with the **Expert** profile.

#### Step by Step

- 1) In the navigation bar, click on **Expert Mode**.
- 2) In the navigation tree, click **Telephony > Payload**.
- 3) Click **Hardware Modules** in the menu tree.
- 4) Click on the **Edit DSP Settings** tab.

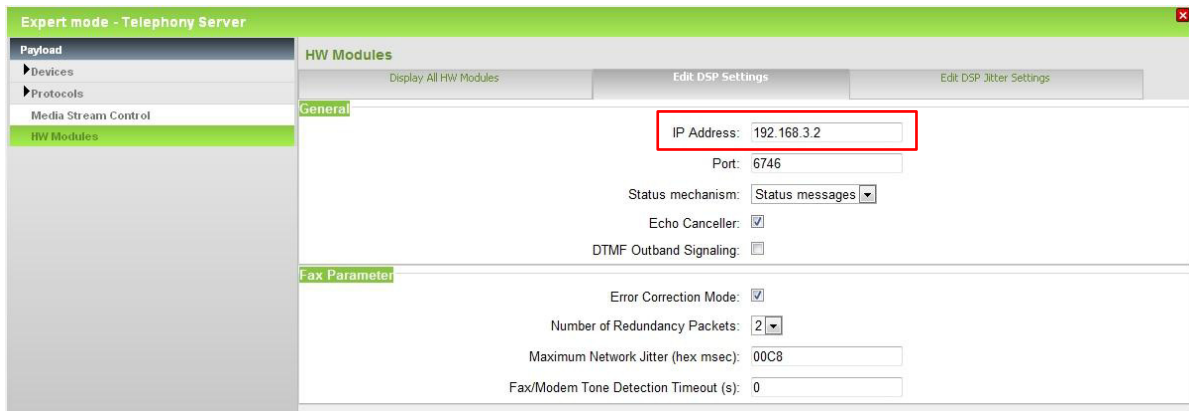

- 5) In the **General** area, enter the IP address 192.168.3.2 under **IP address**. The entire IP address range (192.168.3.xxx) is now blocked for other clients on the LAN.
- 6) Click on **Apply** and confirm with **OK**.

## 8.2 DHCP

DHCP (Dynamic Host Configuration Protocol) is a protocol that enables the dynamic allocation of network-specific data to the IP stations of a network (e.g., a LAN) with the aid of a DHCP server.

DHCP thus makes it possible to automatically integrate IP stations (e.g., IP phones or PCs) in an existing LAN. The IP station must be configured to automatically receive the network-specific data and is thus a DHCP client. The DHCP server provides the IP stations with the network-specific data on request.

## 8.2.1 DHCP Relay Agent

When using the internal DHCP server of the hardware platform, the internal DHCP server and the DHCP clients must be on the same network segment. If this is not the case, the hardware platform must be configured as a DHCP relay agent. The DHCP requests of the IP stations are then forwarded from the hardware platform to the actual DHCP server.

### 8.2.1.1 How to Configure the Hardware Platform as a DHCP Relay Agent

If the hardware platform is configured as a DHCP relay agent, it relays DHCP requests on to the external DHCP server.

#### Prerequisites

- You are logged into the WBM with the **Expert** profile.

#### Step by Step

- 1) In the navigation bar, click on **Expert Mode**.
- 2) Click on **Telephony > Network Interfaces** in the navigation tree.
- 3) Click on **Motherboard > DHCP** in the menu tree.
- 4) Enable the **DHCP Relay Agent** radio button.
- 5) Click on **Apply** and confirm with **OK**.
- 6) Click **DHCP Relay Agent** in the menu tree.

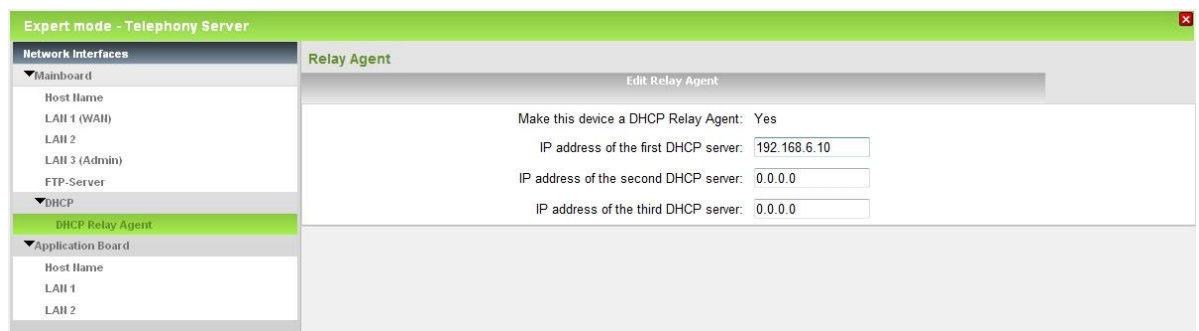

- 7) Enter the **IP address of the first DHCP server**.
- 8) Enter the **IP address of the second DHCP server**.
- 9) Enter the **IP address of the third DHCP server**.

---

**INFO:** You can enter up to three DHCP servers. The entry of the first DHCP server is mandatory.

---

- 10) Click on **Apply**, followed by **OK**.

## 8.2.2 DHCP Server

The DHCP server assigns network-specific information such as the IP address and subnet mask of the IP station, the IP address of the default gateway, the IP address of the SNTP server, etc., dynamically to the IP stations (i.e., the IP phones, SIP phones, PCs, WLAN access points, and so on).

The internal DHCP server of the communication system or an external DHCP server can be used as DHCP server (e.g., the DHCP server of the Internet router).

In the hardware platform, the integrated DHCP server is enabled by default. If an external DHCP server is to be used, the internal DHCP server must be disabled. Otherwise, conflicts may arise with the external DHCP server.

For the softswitch, the Linux server can be configured as an internal DHCP server.

The decision as to whether the internal DHCP server of the communication system or an external DHCP server is to be used should be made during the initial startup. The internal DHCP server can also be enabled or disabled later. Even the network-specific data can be configured later.

### Internal DHCP Server

If the internal DHCP server is used, the IP stations are automatically supplied with the following network-specific data:

- IP address and subnet mask of the IP station
- IP address of the communication system (default gateway)
- IP address of the SNTP server (to obtain the date and time)
- IP address of the DNS server (for name resolution)
- IP address of the SIP server (for the authentication of SIP stations)
- IP address of the internal DLI or the external DLS server (for the software update of the IP system phones)
- Routing rules

### External DHCP Server

If an external DHCP server is used, it must support a vendor-specific option space to enable the provision of vendor-specific parameters. The following network-specific data should be entered in the external DHCP server:

- IP address and subnet mask of the IP station
- IP address of the default router = Option 3
- IP address of the communication system (default gateway) = Option 33
- IP address of DNS server (for name resolution) = Option 6
- IP address of the internal DLI or the external DLS server (for the software update of the IP system telephones) = Option 43
- Only for SIP phones: IP address of the SIP server (SIP registrar, for the authentication of SIP stations) = Option 120
- Only for SIP phones: IP address of the SNTP server (to supply the SIP phones with the date and time) = Option 42

---

**INFO:** Additional information on DHCP server in a Windows environment can be found here: [http://wiki.unify.com/wiki/DHCP\\_Server\\_in\\_a\\_Windows\\_environment](http://wiki.unify.com/wiki/DHCP_Server_in_a_Windows_environment).

---

If no such entries can be made at the external DHCP server, this data must be entered directly at the IP system phones. Only then can the IP system phones be automatically supplied with the current date and time and the latest software updates, for example.

For further information please refer to the following Unify Experts Wiki page under: <http://wiki.unify.com/wiki/DHCP>

### **DHCP Address Pool (IP Address Ranges)**

Whenever an IP station logs in at the DHCP server, it receives, among other things, a dynamically assigned IP address. The administrator can optionally define an IP address range from which the DHCP server can assign IP addresses to the IP stations. In this case, for example, not all IP addresses from the range 192.168.1.xx are to be assigned, but only those from 192.168.1.50 to 192.168.1.254, since the lower IP addresses up to 192.168.1.49 are to be reserved for IP stations with static IP addresses.

In fact, even multiple IP address ranges can set up for the internal DHCP server under **Network Interfaces** in expert mode.

## **8.2.2.1 How to Enable and Configure the DHCP Server of the Hardware Platform**

The **Network Configuration** wizard can be used to enable and configure the DHCP server of the hardware platform.

### **Prerequisites**

- You are logged on to the WBM with the **Advanced** profile.

### **Step by Step**

- 1) In the navigation bar, click on **Setup**.
- 2) In the navigation tree, click **Wizards > Network/Internet**.
- 3) Click on **Edit** to start the **Network Configuration** wizard.

## Integration into the Internal Data Network (LAN) DHCP

The screenshot shows the 'DHCP Global Settings' configuration page. It includes the following fields and options:

- Enable DHCP Server:**
- Netmask:** 255.255.255.0
- Broadcast Address:** 0.0.0.0 (optional)
- Default Gateway:** Preferred Gateway: 192.168.1.1
- DNS Server:** Domain Name: (empty), Preferred Server: 192.168.1.1
- Lease time in hours (0 infinite):** 1
- Enable Dynamic DNS Update:**

- 4) Enable the **DHCP Server** check box.
- 5) Enter the subnet mask of your network in the **Subnet Mask** field (e.g., 255.255.255.0).
- 6) In the **Broadcast Address** field, enter the Broadcast address ("last" IP address of the net or subnet, default: 0.0.0.0) if required.
- 7) In the field **Preferred Gateway**, enter the IP address of the default gateway. As a rule, the IP address for the Internet router is usually 192.168.1.1.
- 8) If you need a fully qualified domain name for the DHCP server, enter this under **Domain Name** (max. 80 characters).
- 9) In the field **Preferred Server**, enter the IP address of an available DNS server, e.g., the IP address of the Internet router, 192.168.1.1.
- 10) If required, enter the maximum lease time in hours (default: 1 h, 0 = infinite lease time) in the field **Lease Time in hours (0 = infinite)**.
- 11) If you want to permit dynamic updates of the DNS server, enable the option **Enable Dynamic DNS Update** (default: disabled).

---

**INFO:** If Dynamic DNS Update option is enabled, it is mandatory to configure **Domain Name** in IP Address Pool respective Domain name field.

---

- 12) Click on **OK & Next**. The settings for the DHCP address pool are displayed.

The screenshot shows the 'DHCP Address Pool' configuration page. It includes the following fields:

- Subnet address:** 192.168.1.0
- Subnet mask:** 255.255.255.0
- Address range:** Address range 1: 192.168.1.50 - 192.168.1.254

- 13) In the **Subnet Address** field, enter the lowest IP address of the subnet in which the desired IP address range is located (in our example, 192.168.1.0).
- 14) Enter the subnet mask of the desired IP address range in the **Subnet Mask** field (e.g., 255.255.255.0).
- 15) Enter the upper and lower threshold for the desired IP address range in the **Address Range 1** field (e.g., 192.168.1.50 to 192.168.1.254).



- 16) Click on **OK & Next**. The **Routing Settings** window appears.
- 17) In the field **IP Address of DNS Server**, enter the IP address of an available DNS server, e.g., the IP address of the Internet router, 192.168.1.1.
- 18) Select the item **LAN** from the **Default Routing via** drop-down list.
- 19) If access to the Internet occurs via an Internet router, enter the IP address of the Internet router (e.g., 192.168.1.1) in the **IP address of Default Router** field.
- 20) Click on **OK & Next** followed by **Finish**.

### 8.2.2.2 How to Disable the DHCP Server of the Hardware Platform

The **Network Configuration** wizard can be used to deactivate the DHCP server of the hardware platform.

#### *Prerequisites*

- You are logged on to the WBM with the **Advanced** profile.

#### *Step by Step*

- 1) In the navigation bar, click on **Setup**.
- 2) In the navigation tree, click **Wizards > Network/Internet**.
- 3) Click on **Edit** to start the **Network Configuration** wizard.
- 4) Clear the **Enable DHCP Server** check box.
- 5) Keep clicking **OK & Next** until you receive a message that the feature has been installed.
- 6) Click on **Finish**.

### 8.2.2.3 How to Enable and Configure the DHCP Server of the Softswitch

#### *Step by Step*

- 1) Click on **Computer** in the task bar.
- 2) In the menu tree, click on **System > YaST**.
- 3) Enter the password for the root user and click **Continue**. The YaST Control Center is opened.
- 4) Click on **Network Services** in the menu tree.
- 5) In the **Network Services** area, click on **DHCP Server**.
- 6) Mark the desired network card and click **Select**.
- 7) Select the **Open Firewall for Selected Interfaces** check box.
- 8) Click on **Next**.

- 9) If you need a fully qualified domain name for the DHCP server, enter this under **Domain Name** (max. 80 characters).
- 10) In the field **Primary Name Server IP**, enter the IP address of an available DNS server, e.g., the IP address of the Internet router, 192.168.1.1.
- 11) In the field **Default Gateway (Router)**, enter the IP address of the default gateway. As a rule, the IP address for the Internet router is usually 192.168.1.1.
- 12) Enter the SNTP server configured during initial setup in the **NTP Time Server** field.
- 13) Click on **Next**.
- 14) Enter the lower limit of the desired IP address range in the field **First IP Address** and its upper limit in the field **Last IP Address** (e.g., 192.168.1.50 to 192.168.1.254).
- 15) Select the **Allow Dynamic BOOTP** check box.
- 16) Click on **Next**.
- 17) Enable the **When Booting** radio button.
- 18) Click on **Finish**.
- 19) Close the **YaST Control Center**.

#### 8.2.2.4 How to Disable the DHCP Server of the Softswitch

##### *Step by Step*

- 1) Click on **Computer** in the task bar.
- 2) In the menu tree, click on **System > YaST**.
- 3) Enter the password for the root user and click **Continue**. The YaST Control Center is opened.
- 4) Click on **Network Services** in the menu tree.
- 5) In the **Network Services** area, click on **DHCP Server**.
- 6) Clear the **Start DHCP Server** check box.
- 7) Click on **Finish**.
- 8) Close the **YaST Control Center**.

### 8.3 DNS - Name Resolution

The Domain Name Service (DNS) serves to the translate names to numerical addresses. This enables host names or domain names to be converted to IP addresses, and vice versa.

The DNS uses a hierarchical database that manages the Internet name space and is distributed over a collection of servers worldwide. This name space is divided into so-called zones (domains). Separate Internet-independent DNS servers are usually operated for local requirements – for example, within a corporate network.

### Name Resolution for IP System Phones

The following prerequisites must be met:

- Windows 2008 DNS Server (with the current patch level and the "Allow unsafe update" setting enabled)
- The internal DHCP server is enabled
- The "Enable Dynamic DNS Update" functionality is activated in the internal DHCP server (see [DHCP Server](#))
- The web name is entered in the IP system telephone.

The IP system telephone sends a DHCP request (1) and receives a valid IP address and other network-specific data (2) from the internal DHCP server. After receiving this data, the IP system telephone sends the set web name to the internal DHCP server (3), which then forwards the name automatically to the configured DNS server (4). The DNS server now knows the name associated with the IP address of the IP system telephone. The IP system telephone can now be accessed via the WBM by using its web name (5).

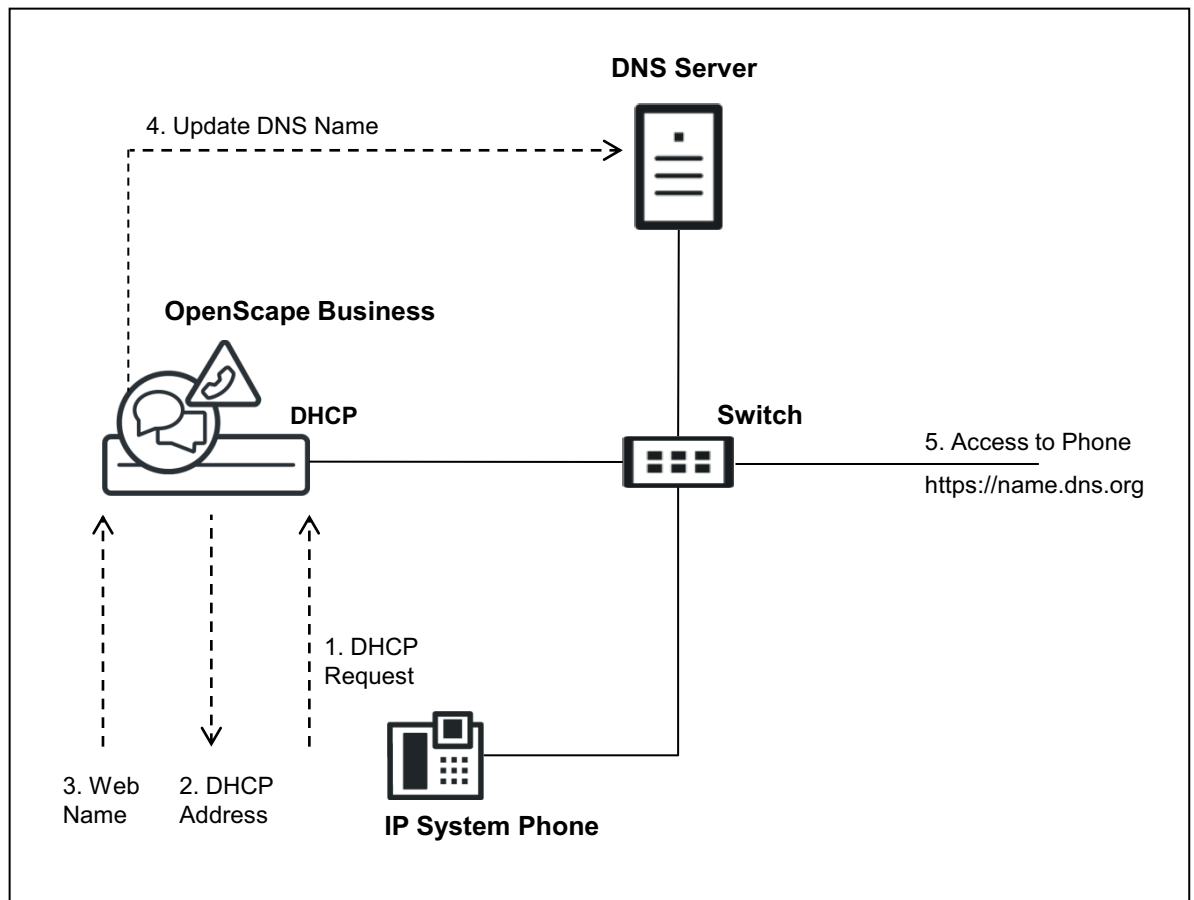

### DNS Server

The DNS server, also called a name server, is a program that responds to requests about domain names or computer names. Even the PC on which this program runs can be designated as a DNS server.

For requests about a domain name or a host name, the DNS server returns the corresponding IP address.

Example: for `www.wikipedia.org`, DNS server on the Internet will return the IP address `91.198.174.2`.

If the preferred DNS server cannot answer a request, it forwards the request to another DNS server.

For a softswitch, the Linux server on which the communication software runs can be configured as a DNS server. The hardware platform cannot be used as a DNS server. An external DNS server can be specified for both the softswitch as well as the hardware platform.

## 8.3.1 How to Define an External DNS Server

### Prerequisites

- You are logged into the WBM with the **Expert** profile.

### Step by Step

- In the navigation bar, click on **Expert Mode**.
- In the navigation tree, click **Telephony > Routing**.
- Navigate in the menu tree to **IP Routing > Mainboard > DNS Server**. The **Edit DNS Settings** window appears.

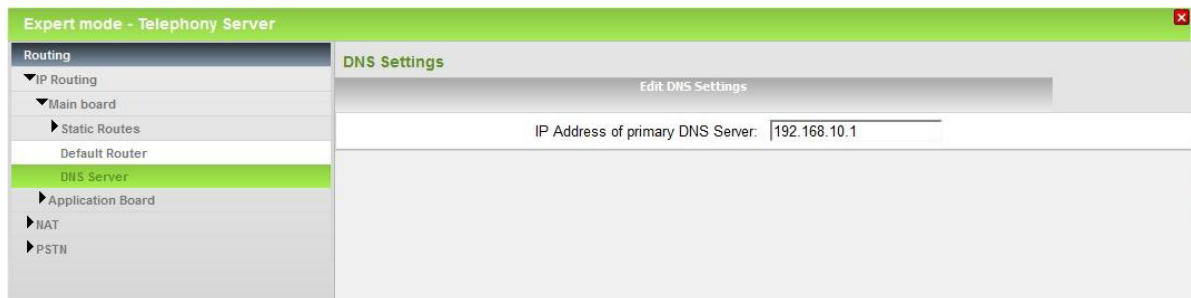

- Enter the IP address of the relevant external DNS server in the field **IP Address of DNS Server**.
- Click on **Apply** followed by **OK**.

---

**INFO:** In case of an OpenScape Business S system, a system reboot is necessary in order the changes to be applicable.

---

## 8.4 IP Routing

In data technology, IP routing describes the definition of paths (routes) for data streams within networks. IP routing is required when the sender and recipient are on different networks.

### Default Router

To ensure that IP stations can also reach destinations outside their own networks that are not explicitly listed in a route table, a gateway must be specified for forwarding packets of this kind (default router). The default router will then redirect the data to the parent network.

You can enable or disable IP routing via a default router for both the mainboard and the Application Board.

### Static Routes

Static routes are used to establish the path along which data will travel to a network that cannot be reached via the default router.

You can create static routes for both the mainboard and the Application Board.

### 8.4.1 How to Activate or Deactivate the Default Router

#### Prerequisites

- You are logged into the WBM with the **Expert** profile.

#### Step by Step

- In the navigation bar, click on **Expert Mode**.
- In the navigation tree, click **Telephony > Routing**.
- Navigate in the menu tree to **IP Routing > Mainboard / Application Board > Default Router**. The **Edit Default Router** window appears.

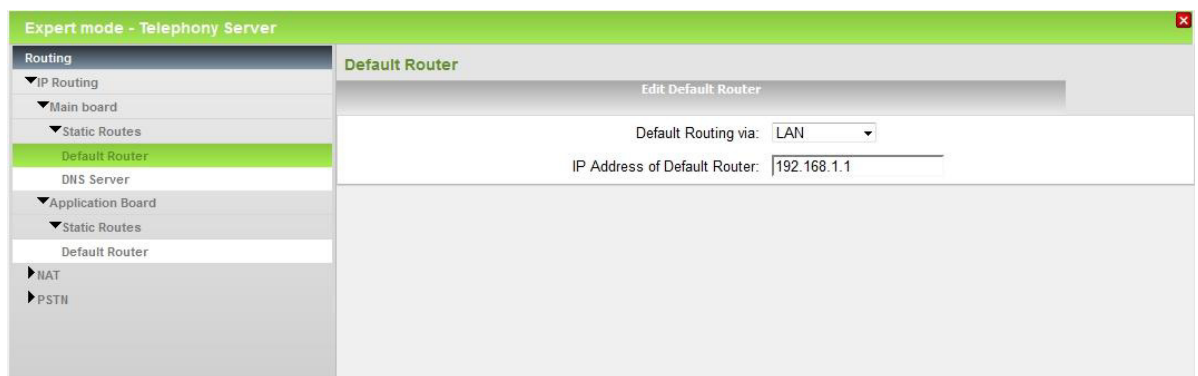

- If you want to enable IP routing over a default router, select the entry **LAN** in the **Default Routing via** list box and enter the IP address of the default router

## Integration into the Internal Data Network (LAN)

### IP Routing

e.g., the IP address of the Internet router **192.168.1.1** under IP Address of Default Router.

- 5) If you want to disable IP routing over a default router, select the entry **No interface** in the **Default routing via** list box.
- 6) Click on **Apply** followed by **OK**.

## 8.4.2 How to Add a Static Route

### Prerequisites

- You are logged into the WBM with the **Expert** profile.

### Step by Step

- 1) In the navigation bar, click on **Expert Mode**.
- 2) In the navigation tree, click **Telephony > Routing**.
- 3) Navigate in the menu tree to **IP Routing > Mainboard / Application Board > Static Route**. The **Static Routes** window is displayed.
- 4) Click on the **Add Static Route** tab. The **Route Index** shows which route is added.

The screenshot shows the 'Static Routes' configuration window. The left sidebar contains a navigation tree with 'Routing' expanded, showing 'Mainboard' and 'Application Board' expanded, and 'Static Routes' selected under both. The main content area has two tabs: 'Display Static Route Table' and 'Add Static Route'. The 'Add Static Route' tab is active, showing the following fields:

- Route Index: 1
- Route Name:
- Destination Network/Host:
- Subnet Mask:
- Route Gateway:

- 5) Enter the required name for this route in the **Route Name** field.
- 6) Enter the IP address of the **Destination Network/Host**.
- 7) Enter the IP address of the **Destination Subnet Mask** (subnet mask).
- 8) Enter the IP address of the router you want to use to reach the destination network in the **Route Gateway** field.
- 9) If you have created one or more static routes for the mainboard, you can copy all static routes of the mainboard to the Application Board with the **Copy to OCAB** button.
- 10) Click on **Apply** followed by **OK**.

## 8.4.3 How to Delete Static Routes

### *Prerequisites*

- You are logged into the WBM with the **Expert** profile.

### *Step by Step*

- 1) In the navigation bar, click on **Expert Mode**.
- 2) In the navigation tree, click **Telephony > Routing**.
- 3) Navigate in the menu tree to **IP Routing > Mainboard / Application Board > Static Routes**.
- 4) Mark the route you want to delete.
- 5) Click the **Delete Static Route** tab.
- 6) Click on **Delete**.
- 7) Confirm the advisory message and then click **OK**.

## 8.5 Deployment Service (DLS and DLI)

DLI and DLS can be used to manage IP components centrally and to deploy their software. The DLI is integrated in the communication system. The DLS is a standalone application which must be installed on an external server PC.

### **DLI (Deployment Server Integrated)**

The DLI is a component which is integrated in the communication system and provides limited DLS functionality. The internal DLI can be used to centrally configure all IP system phones connected to the communication system and to equip them with the latest phone software.

The internal DLI also works with the integrated FTP server on which the latest phone software is stored.

If the IP address of the DLI is known to the DHCP server, the DHCP server sends this data to the IP system telephone (HFA, SIP) as soon as the phone logs into the internal network. This enables the telephone to retrieve the current software from the FTP server of the communication system. The DLI is configured by default in the internal DHCP server. If an external DLS server is to be used instead, its IP address must be configured in the internal DHCP server.

### **DLS (Deployment Service)**

The DLS is a client/server application for the central administration of the IP components. The DLS server is not integrated in the communication system and must be installed on a server PC. The DLS client runs on the IP components. Administration occurs via a web browser.

IP components can be IP system phones, SIP phones, SIP clients and IP gateways.

**Integration into the Internal Data Network (LAN)**  
 Deployment Service (DLS and DLI)

---

**INFO:** The properties and features of the DLS can be found in the product description of the DLS and are not described in this documentation.

---

**DLI or DLS with External DHCP Server**

In order to ensure that the software of IP system telephones (HFA, SIP) can be updated automatically even when using an external DHCP server, you have the following alternatives:

- Configure the IP address of the DLI or DLS in the external DHCP server  
 When using an external DHCP server, the network-specific data and the IP address of the external deployment server (DLI or external DLS server) must be entered. In addition, the latest phone software must be stored on the external DLS server.
- Configure all system phones  
 The IP address of the deployment server must be entered as the DLS address for each IP system phone (IP address of the communication system for the internal DLI or IP address of the external DLS server).

**Features and Restrictions**

Function	DLI	DLS
Central configuration of the parameters of IP components The parameters of the IP components can be configured via customizable XML templates.	yes	yes
Plug&Play commissioning of the IP components Using a DHCP server, the IP components can log into the system automatically after being connected to the system for the first time or after an IP component is replaced, for example.	Yes	Yes
Central and automatic software update for IP components Whenever a new software version is available, the IP components are automatically supplied with the latest version of the software the first time the user logs on. The IP address of the DLI/DLS must be configured in the IP component.	Yes	Yes The latest phone software must be stored on the DLS.
Centralized inventory management of IP components The data on the hardware configurations of the IP components can be accessed and retrieved centrally.	no	Yes



Function	DLI	DLS
Support for IP Mobility (Desk Sharing)  The telephony data of a user (e.g., program keys, directory entries, journals) is stored centrally and can be retrieved at other phones).	Yes  Not for SIP phones,  Not possible in the internetwork.	Yes  Not for SIP phones,  In homogeneous networks (only OpenScape Business systems), only with closed numbering,  Not in heterogeneous networks (with OpenScape 4000 or OpenScape Voice).
SPE support in networks	SPE in networks is possible. DLS has to be used (no DLI).	SPE in networks is currently not possible because the SDES protocol has not been implemented. This applies regardless of whether the DLS is used.
Central supply for several different platforms	no	Yes
Activation of the 2nd LAN interface of IP system phones (PC Ethernet mode).  See <a href="#">Basic Settings &gt; Phone Parameter Deployment</a>	Yes	Yes

### Deployment- und Licensing Client (DLSC)

To use DLS functions such as the element manager, for example, the communication system must allow the external DLS to access the configuration data. The communication system is then operated as Deployment and Licensing Client.

## 8.5.1 How to Configure the External DLS Server in the Internal DHCP Server

### Prerequisites

- You are logged into the WBM with the **Expert** profile.

### Step by Step

- 1) In the navigation bar, click on **Expert Mode**.
- 2) Click on **Telephony > Network Interfaces** in the navigation tree.
- 3) Navigate in the menu tree to **Mainboard > DHCP > DHCP Server > Global Settings**. The **Edit Global Parameters** window is displayed.

## Integration into the Internal Data Network (LAN) Deployment Service (DLS and DLI)

The screenshot shows the 'Expert mode - Telephony Server' configuration window. The left sidebar contains a navigation tree with the following items: Network Interfaces (Mainboard, Host Name, LAH 1 (WAIH), LAH 2, LAH 3 (Admin), FTP-Server), DHCP (DHCP-Server, Global Parameters, IP Address Pools, All Leases, Static IP Addresses, Last active Leases), and Application Board (Host Name, LAH 1, LAH 2). The main area is titled 'Global Parameters' and contains the following fields: Enable DHCP Server: ; Netmask: 255.255.255.0; Broadcast Address: 0.0.0.0 (optional); Default Gateway: Gateway 1: 192.168.1.2, Gateway 2: 0.0.0.0, Gateway 3: 0.0.0.0; DNS Server: Domain Name: [empty], Server 1: 192.168.1.2, Server 2: 0.0.0.0, Server 3: 0.0.0.0; Lease time in hours (0 infinite): 1; Enable Dynamic DNS Update: ; Use Internal DLI:  (highlighted with a red box); External DLS Server: IP Address: 192.168.1.100, Port: 18443.

- 4) Clear the **Use Internal DLI** check box.
- 5) Enter the IP address at which the server can be reached in the **IP Address** field.
- 6) Enter the port used by the DLS server in the **Port** field. This port must be enabled in the firewall.
- 7) Click on **Apply**, followed by **OK**.

## 8.5.2 How to Enable the Internal DLI

### Prerequisites

- You are logged into the WBM with the **Expert** profile.

### Step by Step

- 1) In the navigation bar, click on **Expert Mode**.
- 2) Click on **Telephony > Network Interfaces** in the navigation tree.
- 3) Navigate in the menu tree to **Mainboard > DHCP > DHCP Server > Global Settings**. The **Edit Global Parameters** window is displayed.

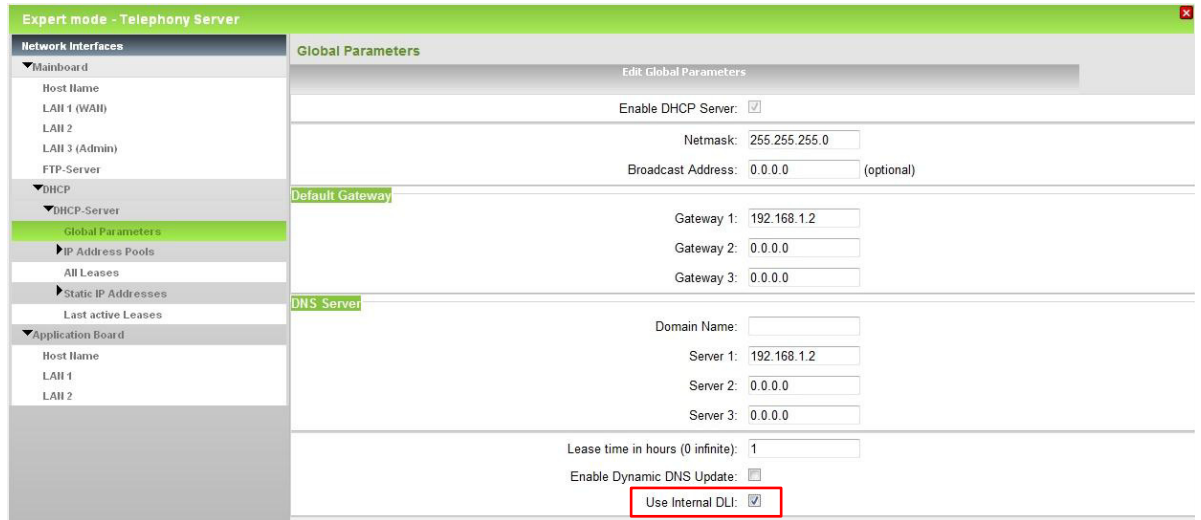

- 4) Enable the **Use Internal DLI** check box. This check box is enabled by default.
- 5) Click on **Apply**, followed by **OK**.

## 8.5.3 How to Configure the Communication System as a Deployment and Licensing Client

### Prerequisites

- You are logged into the WBM with the **Expert** profile.

### Step by Step

- 1) In the navigation bar, click on **Expert Mode**.
- 2) In the navigation tree, click **Telephony > Security**.
- 3) Click **Deployment and Licensing Client (DLSC)** in the menu tree.

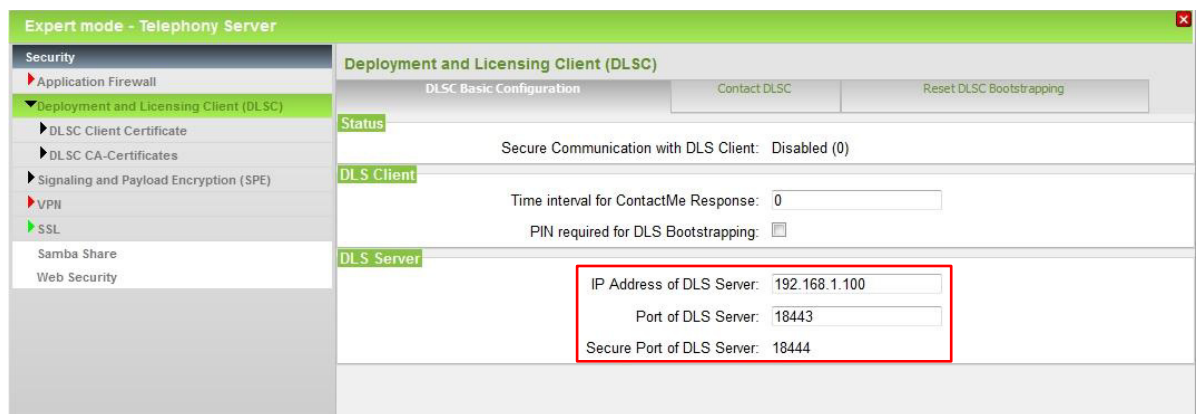

- 4) On the **DLSC Basic Configuration** tab in the **DLS Server** area, enter the IP address at which the external DLS server can be reached in the **IP Address of DLS Server** field.

## Integration into the Internal Data Network (LAN)

Deployment Service (DLS and DLI)

- 5) Enter the port used by the DLS server in the **Port of DLS Server** field. The two displayed ports must be enabled in the firewall.
- 6) Click on **Apply** followed by **OK**.

## 9 Connection to Service Provider

The communication system supports connection to public communication networks. The connection to the IP network provides access to the Internet and Internet telephony, and the connection to the Central Office provides access to the ISDN network and the analog network.

Access to the Internet occurs via either an Internet modem or an Internet router.

ISDN trunk access for the hardware platforms occurs via the mainboard or additional plug-in boards. ISDN trunk access is not possible with the softswitch.

The analog trunk access for the hardware platforms requires an additional plug-in board. Analog trunk access is not possible with the softswitch.

### 9.1 Internet Access

A broadband connection (DSL or connection) is required for access to the Internet. This enables fast data transfers within the framework of the available bandwidth.

#### Internet Access via a DSL Connection

Conventional telephone lines are used for broadband Internet access via DSL (digital subscriber line). The Internet access can be used at the same time as the normal phone. Fax, analog phone or ISDN are also available during the DSL connection. This makes it possible to implement Internet access that is permanently available as in the case of a dedicated line (flat rate).

For Internet access via DSL, you need a modular jack (analog or ISDN) and an Internet Service Provider (ISP). The ISP provides a splitter and an Internet modem (DSL modem) or an Internet router with a built-in Internet modem. The splitter divides the signal into DSL and telephony parts and forwards the DSL signals to the Internet modem.

The communication system can be connected directly to the Internet modem or to the Internet router with an integrated Internet modem. In the first case, the access data of the ISP must be entered in the communication system; in the second, the Internet router must be made known to the communication system. The access data of the ISP is saved in the Internet router.

To use Internet telephony, you will also need an Internet Telephony Service Provider (ITSP, SIP provider).

#### Internet Access via a Cable Connection

The broadband connection to the Internet is implemented via the TV cable. In addition to transmitting TV signals, the TV cable connection can be used for accessing the Internet and making calls. This means you do not need a telephone line to surf and for telephony.

For Internet access via cable, you need a cable provider that offers this feature. The cable provider is also your Internet Service Provider (ISP). This cable

provider supplies you with a cable port with a back channel and a cable modem that transmits the data over the TV cable network. The cable port and the communication system are connected to the cable modem over Ethernet. Internet data filtration takes place directly in the cable modem.

The communication system can be connected directly to the cable modem or to an Internet router that is connected to the cable modem. In both cases, the cable modem or the Internet router must be made known to the communication system.

To use Internet telephony, you will also need an Internet Telephony Service Provider (ITSP, SIP provider).

### Configuring Internet Access

The configuration of Internet access in the WBM depends on whether the Internet connection has already been set up in an external router or whether it occurs via an Internet modem and thus needs to be set up in the WBM.

- **Internet access through an Internet modem (DSL at WAN port directly)**  
You want to operate the communication system directly at an Internet modem (DSL, cable, UMTS ...). OpenScape Business has the Internet router integrated. Enter the access data of the Internet Service Provider (ISP) directly in the communication system and use the WAN port of the communication system. This option is not available with the softswitch.

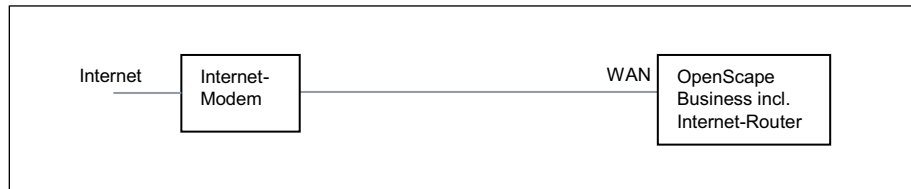

You have the following options:

- Internet access via a preconfigured ISP
- Internet access via the standard ISP PPPoE
- Internet access via the standard ISP PPTP

If your ISP is not listed under the preconfigured ISPs, use the default ISP PPPoE or PPTP.

- **Internet access via an external Internet router**  
You want to operate the communication system at an external Internet router. The Internet Service Provider is already configured in the Internet router. You have the following options:

- **Internet access via an external Internet router at the WAN port (TCP/IP at WAN port via an external router)**

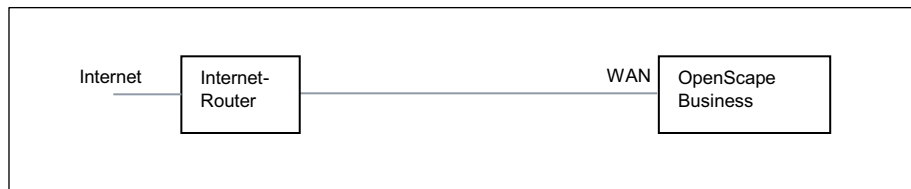

To do this, you use the WAN port of the communication system. OpenScape Business either knows the Internet router or works as a DHCP client. This option can be used if the Internet router is located in another network segment and has its own DHCP server.

- **Internet access via an external Internet router at the LAN port (TCP/IP at LAN port via an external router)**

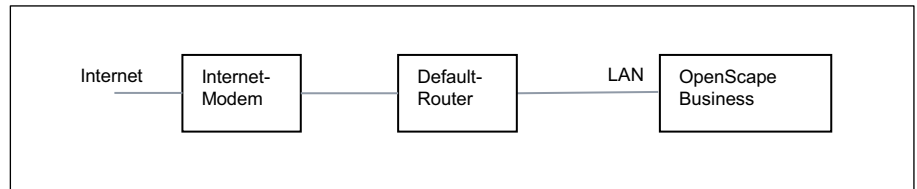

To do this, you use the LAN port of the communication system. OpenScape Business knows only the default router and not the underlying infrastructure. To activate the connection to the Internet router, the IP address of the default router and that of the DNS server must be made known to the communication system.

- **Disable Internet access** (default setting)  
You do not want to use the Internet. Then leave the Internet access disabled.

## 9.1.1 Internet Access via an External Internet Router

The **Internet Configuration** wizard helps you configure your Internet access via an additional Internet router.

To set up Internet access, you have the following options:

- **Internet access via an external Internet router at the LAN port**  
To do this, you use the LAN port of the communication system. To activate the connection to the Internet router, the IP address of the default router and that of the DNS server must be made known to the communication system.
- **Internet access via an external Internet router at the WAN port**  
To do this, you use the WAN port of the communication system. This option can be used if the Internet router is located in another network segment and has its own DHCP server.

### 9.1.1.1 How to Configure Internet Access via an External Internet Router over the LAN Port

The **Internet Configuration** wizard helps you configure the Internet access if the communication system is operated downstream of an additional Internet router. The communication system and the Internet router are in the same LAN segment. You must enter the IP address of the Internet router and the DNS server for this.

### Prerequisites

- You are logged on to the WBM with the **Advanced** profile.
- Für OpenScape Business X: The communication system is connected to the customer network via the "LAN" port. The "WAN interface must not be used for this purpose.
- Für OpenScape Business S: The Linux server is connected to the customer network via the LAN interface of the network card.

### Step by Step

- 1) In the navigation bar, click on **Setup**.
- 2) In the navigation tree, click **Wizards > Network / Internet**.
- 3) Click on **Edit** to start the **Internet Configuration** wizard.
- 4) Disable the **No Internet Access** check box.
- 5) Activate the radio button **TCP/IP at LAN Port via an external router** and click on **OK & Next**.

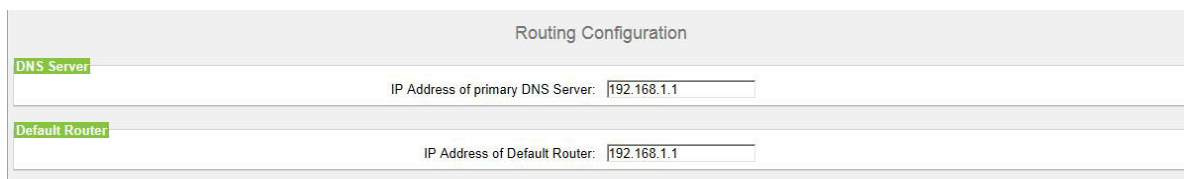

The screenshot shows a 'Routing Configuration' window with two sections. The first section, 'DNS Server', has a text input field for 'IP Address of primary DNS Server' containing '192.168.1.1'. The second section, 'Default Router', has a text input field for 'IP Address of Default Router' also containing '192.168.1.1'.

- 6) Enter the IP address of the local DNS server (e.g., the Internet router) or the Internet DNS server (for Internet telephony, for example) in the **IP Address of DNS Server** field.
- 7) Enter the IP address of the external Internet router in the **IP Address of Default Router** field.
- 8) Click on **OK & Next** followed by **Finish**.

### 9.1.1.2 How to Configure Internet Access via an External Internet Router over the WAN Port

The **Internet Configuration** wizard helps you configure the Internet access if the communication system is operated downstream of an additional Internet router. The communication system and the Internet router must not be located in the same LAN segment.



### Prerequisites

- You are logged on to the WBM with the **Advanced** profile.
- The communication system must be connected to the LAN segment of the customer network in which the Internet router is located via the "WAN" interface.
- You are in the **Configure Internet Access** window.

### Step by Step

- 1) In the navigation bar, click on **Setup**.
- 2) In the navigation tree, click **Wizards > Network / Internet**.
- 3) Click on **Edit** to start the **Internet Configuration** wizard.
- 4) Disable the **No Internet Access** check box.
- 5) Activate the radio button **TCP/IP at WAN Port via an external router** and click **OK & Next**.

Internet Access

Automatic Address Configuration (via DHCP):

Accept IP Address of the Default Router:

Accept IP Address of the DNS Server:

Accept IP Address of the SNTP Server:

MAC Address : 00:1a:e8:5d:09:92

Ethernet Link Mode: Auto

Max. Data Packet Size (bytes): 1500

Network Address Translation:

Bandwidth Control for Voice Connections: None

Bandwidth for Downloads: 10000

Bandwidth for Uploads: 2000

Bandwidth Used for Voice/Fax (%): 80

IEEE802.1p/q Tagging:

IEEE802.1p/q VLAN ID: 0

- 6) If the network-specific data for the WAN interface are to be obtained from an already active DHCP server:
  - a) Select the check box **Automatic Address Configuration (with DHCP)**.
  - b) Select the **Accept IP Address of the Default Router** check box if you want this IP address to be used.
  - c) Select the check box **Accept IP Address of the DNS Server** if required.
  - d) Select the check box **Accept IP Address of the SNTP Server** if required.
- 7) If a fixed IP address is to be assigned to the WAN interface:
  - a) Clear the check box **Automatic Address Configuration (with DHCP)**.
  - b) Enter the desired **IP address** and **Netmask** of the WAN interface.
- 8) Enable the **NAT** check box.

- 9) If you also want to use Internet Telephony, select the item **Upload only** or **Upload and Download** as needed from the **Bandwidth Control for Voice Connections** drop-down list. If the download bandwidth is high and the upload bandwidth is low, bandwidth control should only be activated for the upload direction to ensure that the download bandwidth reserved for voice transmission is not unnecessarily high.
- 10) In the **Bandwidth for Downloads** and **Bandwidth for Uploads** fields, enter the bandwidth in Kbps for downloads and uploads, respectively, as provided by your Internet Service Provider.
- 11) Click on **OK & Next**, followed by **Finish**.

## 9.1.2 Internet Access via an Internet Modem

The **Internet Configuration** wizard helps you configure your Internet access via an Internet modem. An Internet modem is directly connected for this to the WAN port on your communication system. You can use an ISP that was preconfigured in the communication system or a standard ISP type (consult ISP for type).

To set up Internet access, you have the following options:

- **Setting up Internet Access via a Preconfigured ISP**  
You are using an ISP preconfigured in the communication system. You can then select your preconfigured ISP from a list.
- **Setting up Internet Access via the Standard ISP PPPoE**  
You are using the standard ISP type **Provider PPPoE**. Obtain the required settings from your ISP.
- **Setting up Internet Access via the Standard ISP PPTP**  
You are using the standard ISP type **Provider PPTP**. Obtain the required settings from your ISP.

### Connection Clear-down Depending on the Tariff Model

Depending on the tariff model, you can define whether or not the connection to the ISP should be maintained in the event of inactivity.

- With the flat-rate tariff model, the Internet connection does not have to time out on inactivity. Many ISPs require forced timeout every 24 hours. You can enter the time when the connection should time out.
- With the time-based tariff model, the Internet connection should time out on inactivity. You can specify the inactivity timeout for connection clear-down (for instance, 60 seconds). The connection is automatically reestablished the next time an Internet request is made. If VPN is configured, the connection should not be cleared due to inactivity; the flat rate tariff model should hence be selected here.

---

**INFO:** Network-based programs or services can automatically set up an Internet connection and thereby incur additional connection charges for you if your tariff is time-based.

---

### Bandwidth

Different bandwidths for downloading and uploading are usually provided by the ISP. The bandwidth is specified in Kbps. If Internet telephony is also used, the bandwidth is shared by voice and data transmission. We therefore recommend reserving sufficient bandwidth to guarantee good voice quality during voice transmission. However, this can lead to data transfer bottlenecks (for example, slower downloads) during periods with a high volume of voice transmissions.

You can choose whether bandwidth control for voice connections should be enabled only for uploading for both uploading and downloading. If the download bandwidth is high and the upload bandwidth is low, bandwidth control should be enabled only for uploading to prevent an unnecessarily high amount of download bandwidth from being reserved for voice transmissions.

---

**INFO:** About 128 Kbps of bandwidth is reserved for an Internet call.

---

## 9.1.2.1 How to Configure Internet Access via a Preconfigured ISP

You can use the **Internet Configuration** wizard to set up your Internet access via a preconfigured Internet Service Provider (ISP) in the communication system.

### Prerequisites

- You are logged on to the WBM with the **Advanced** profile.
- Your ISP's Internet access data is available (for example, user account, password, etc.).

### Step by Step

- 1) In the navigation bar, click on **Setup**.
- 2) In the navigation tree, click **Wizards > Network / Internet**.
- 3) Click **Edit** to start the **Internet Configuration** wizard.
- 4) Disable the **No Internet Access** check box.
- 5) Activate the radio button **DSL at WAN Port directly** and click **OK & Next**.

## Connection to Service Provider

### Internet Access

- 6) Select your ISP from the **Internet Service Provider Selection** drop-down list.
- 7) Enter the access data that you received from your ISP in the **Internet Access Data for...** area. The fields in this area are provider-specific. When entering your data, bear in mind that the input is case-sensitive!
- 8) Depending on your tariff model, select one of the following two options under **Full-Time Circuit** in the **Router Settings** area:
  - If you have a flat rate tariff model, enable the radio button **On**. In the **Forced Disconnect at (hour:min)** field, enter the time at which the Internet connection is to be deactivated (e.g., 04:59).
  - If you have a time-based tariff model, enable the radio button **Off**. In the **Disconnect automatically after (seconds)** field, enter the duration of inactivity after which the connection is to be dropped (e.g., 60 seconds).
- 9) Set the following values in the **QoS Parameters** area:
  - a) In the **Bandwidth for Downloads** and **Bandwidth for Uploads** fields, enter the bandwidth in Kbps for downloads and uploads, respectively, as provided by your ISP.
  - b) If you want to use Internet Telephony as well, open the drop-down list **Bandwidth Control for Voice Connections** and select the item **Upload only** or **Upload and Download**, as required. In the field **Bandwidth Used for Voice/Fax (%)**, enter how much bandwidth is to be reserved for voice and fax connections as a percentage value (default value: 80%).
- 10) Click **OK & Next**. You are taken to the **Configure DynDNS-Account** window.
- 11) If you want to use a VPN or remote access and do not have a public static IP address, you will need to have already applied for and set up a DynDNS account (at dyndns.org, for example).
  - a) If your desired DynDNS provider is included in the **Domain name** drop-down list, select it from that list (e.g., dyndns.org).
  - b) If your desired DynDNS provider is not included in the **Domain name** drop-down list, select the **User defined Domain** check box. Enter the desired DynDNS provider in the **Domain name** field and enter the update

URL of the DynDNS provider in the **Update URL** field. The structure of this URL depends on the DynDNS provider. In addition, customer-specific parameters (shown in *italics* in the example) must be supplemented.

```
http://www.anydns.info/  
update.php?user=<username>&password=<pass>&host=<domain>  
&ip=<ipaddr>
```

- c) Enter the **User name** and the **Password** of your DynDNS account.
  - d) Enter the host name assigned to you by the DynDNS provider, omitting the domain name, for instance, myhost, in the **Hostname** field. Your complete domain name would then be myhost.dyndns.org, for example.
  - e) Test the DynDNS account with **Connection test**.
  - f) After the test succeeds, click **OK**.
  - g) Click **OK & Next**.
- 12) If you have a public static IP address or do not want to use a VPN or remote access, click **No DynDNS**.
- 13) Click **Finish**. The communication system performs a restart.

### 9.1.2.2 How to Configure Internet Access via a Standard ISP PPPoE

You can use the **Internet Configuration** wizard to set up your Internet access via the standard Internet Service Provider PPPoE.

#### Prerequisites

- You are logged on to the WBM with the **Advanced** profile.
- The following ISP-specific Internet access data is available to you:

Field	Description	Value from ISP
<b>IP Parameters</b> (only for a fixed IP address)		
<b>Remote IP Address of the PPP Connection</b>	IP address of your ISP's server.	
<b>Local IP Address of the PPP Connection</b>	IP address that was assigned to you by your ISP for Internet access.	
<b>Authentication</b> (via PAP or CHAP). PAP is seldom used, since the authentication is unencrypted.		
<b>PPP User Name</b>	User name that was assigned to you by your ISP for the PPP connection.	
<b>PAP Authentication Mode</b>	Authentication mode for the PPP connection over PAP: <b>PAP Client</b> , <b>PAP Host</b> or <b>Not used</b> .	
<b>PAP Password</b>	Password assigned to you by the ISP for PAP authentication	

**Connection to Service Provider**  
Internet Access

Field	Description	Value from ISP
<b>CHAP Authentication Mode</b>	Authentication mode for PPP connection via CHAP: <b>CHAP Client</b> , <b>CHAP Host</b> , <b>CHAP Client and Host</b> or <b>Not used</b> .	
<b>CHAP Password</b>	Password assigned to you by the ISP for CHAP authentication	
<b>QoS Parameters of Interface</b>		
<b>Bandwidth for Downloads</b>	Value of the full download bandwidth in Kbps provided by the ISP.	
<b>Bandwidth for Uploads</b>	Value of the full upload bandwidth in Kbps provided by the ISP.	

**Step by Step**

- 1) In the navigation bar, click on **Setup**.
- 2) In the navigation tree, click **Wizards > Network / Internet**.
- 3) Click **Edit** to start the **Internet Configuration** wizard.
- 4) Disable the **No Internet Access** check box.
- 5) Activate the radio button **DSL at WAN Port directly** and click **OK & Next**.
- 6) From the **Internet Service Provider Selection** drop-down list, select the standard ISP Type **Provider PPPoE**.
- 7) The **IP parameters** check box in the **IP Parameters** area should only be enabled if the ISP requires an adjustment of these parameters. In this case, enter the values that you have received from your ISP in the **Remote IP Address of the PPP Connection**, **Local IP Address of the PPP Connection** and **Max. Data Packet Size (bytes)** fields. From the **IP Address Negotiation** drop-down list, select the item **Use configured IP address**.
- 8) Depending on your tariff model, select one of the following two options under **Full-Time Circuit** in the **Router Settings** area:
  - If you have a flat rate tariff model, enable the radio button **On**. In the **Forced Disconnect at (hour:min)** field, enter the time at which the Internet connection is to be deactivated (e.g., 04:59).
  - If you have a time-based tariff model, enable the radio button **Off**. In the **Disconnect automatically after (seconds)** field, enter the duration of inactivity after which the connection is to be dropped (e.g., 60 seconds).
- 9) The settings in the **Authentication** area depend on whether or not the ISP requires authentication via PPP.
  - Authentication required by ISP: Make sure that the check box **PPP Authentication** is enabled. Enter the Internet access name of the ISP as the PPP user name. The customary standard is the **CHAP Client** authentication mode.
  - Authentication not required by ISP: Make sure that the check box **PPP Authentication** is disabled.

- 10) If you want to use NAT, enable the **NAT** check box (enabled by default) in the **Address Translation** area.
- 11) Set the following values in the **QoS Parameters of Interface** area:
  - a) In the **Bandwidth for Downloads** and **Bandwidth for Uploads** fields, enter the bandwidth in Kbps for downloads and uploads, respectively, as provided by your ISP.
  - b) If you want to use Internet Telephony as well, open the drop-down list **Bandwidth Control for Voice Connections** and select the item **Upload only** or **Upload and Download**, as required. In the field **Bandwidth Used for Voice/Fax (%)**, enter how much bandwidth is to be reserved for voice and fax connections as a percentage value (default value: 80%).
- 12) Click **OK & Next**. You are taken to the **Configure DynDNS-Account** window.
- 13) If you want to use a VPN or remote access and do not have a public static IP address, you will need to have already applied for and set up a DynDNS account (at dyndns.org, for example).
  - a) If your desired DynDNS provider is included in the **Domain name** drop-down list, select it from that list (e.g., dyndns.org).
  - b) If your desired DynDNS provider is not included in the **Domain name** drop-down list, select the **User defined Domain** check box. Enter the desired DynDNS provider in the **Domain name** field and enter the update URL of the DynDNS provider in the **Update URL** field. The structure of this URL depends on the DynDNS provider. In addition, customer-specific parameters (shown in *italics* in the example) must be supplemented.

```
http://www.anydns.info/  
update.php?user=<username>&password=<pass>&host=<domain>&ip=<ipaddr>
```
  - c) Enter the **User name** and the **Password** of your DynDNS account.
  - d) Enter the host name assigned to you by the DynDNS provider, omitting the domain name, for instance, myhost, in the **Hostname** field. Your complete domain name would then be myhost.dyndns.org, for example.
  - e) Test the DynDNS account with **Connection test**.
  - f) After the test succeeds, click **OK**.
  - g) Click **OK & Next**.
- 14) If you have a public static IP address or do not want to use a VPN or remote access, click **No DynDNS**.
- 15) Click **Finish**. The communication system performs a restart.

### 9.1.2.3 How to Configure Internet Access via a Standard ISP PPTP

You can use the **Internet Configuration** wizard to set up your Internet access via the standard Internet Service Provider PPTP.

**Connection to Service Provider**  
Internet Access

**Prerequisites**

- You are logged on to the WBM with the **Advanced** profile.
- The following ISP-specific Internet access data is available to you:

Field	Description	Value from ISP
<b>IP Parameters</b> (only for a fixed IP address)		
<b>Remote IP Address of the PPP Connection</b>	IP address of your ISP's server.	
<b>Local IP Address of the PPP Connection</b>	IP address that was assigned to you by your ISP for Internet access.	
<b>PPTP Parameter</b>		
<b>Local IP Address of the Control Connection</b>	IP address that was assigned to you by your ISP for the PPTP connection. The default value is 10.0.0.140.	
<b>Remote IP Address of the Control Connection</b>	IP address of your ISP's server for the PPTP connection. The default value is 10.0.0.138.	
<b>Remote Netmask for the Control Connection</b>	Subnet mask that was assigned to you by your ISP for the PPTP connection. The default value is 255.255.255.248.	
<b>Authentication</b> (via PAP or CHAP). PAP is seldom used, since the authentication is unencrypted.		
<b>PPP User Name</b>	User name that was assigned to you by your ISP for the PPP connection.	
<b>PAP Authentication Mode</b>	Authentication mode for the PPP connection over PAP: <b>PAP Client, PAP Host</b> or <b>Not used</b> .	
<b>PAP Password</b>	Password assigned to you by the ISP for PAP authentication	
<b>CHAP Authentication Mode</b>	Authentication mode for PPP connection via CHAP: <b>CHAP Client, CHAP Host, CHAP Client and Host</b> or <b>Not used</b> .	
<b>CHAP Password</b>	Password assigned to you by the ISP for CHAP authentication	
<b>QoS Parameters of Interface</b>		
<b>Bandwidth for Downloads</b>	Value of the full download bandwidth in Kbps provided by the ISP.	
<b>Bandwidth for Uploads</b>	Value of the full upload bandwidth in Kbps provided by the ISP.	

**Step by Step**

- 1) In the navigation bar, click on **Setup**.
- 2) In the navigation tree, click **Wizards > Network / Internet**.
- 3) Click **Edit** to start the **Internet Configuration** wizard.



- 4) Disable the **No Internet Access** check box.
- 5) Activate the radio button **DSL at WAN Port directly** and click **OK & Next**.
- 6) From the **Internet Service Provider Selection** drop-down list, select the standard ISP Type **Provider PPTP**.
- 7) The **IP parameters** check box in the **IP Parameters** area should only be enabled if the ISP requires an adjustment of these parameters. In this case, enter the values that you have received from your ISP in the **Remote IP Address of the PPP Connection**, **Local IP Address of the PPP Connection** and **Max. Data Packet Size (bytes)** fields. From the **IP Address Negotiation** drop-down list, select the item **Use configured IP address**.
- 8) Enter the values that you received from your ISP in the **PPTP Parameter** area.
- 9) If you have a time-based tariff model, select the **Short Hold** check box. In the **Short Hold Time (sec)** field, enter the duration of inactivity after which the connection is to be dropped (e.g., 60 seconds).
- 10) The settings in the **Authentication** area depend on whether or not the ISP requires authentication via PPP.
  - Authentication required by ISP: Make sure that the check box **PPP Authentication** is enabled. Enter the Internet access name of the ISP as the PPP user name. Make the PAP and CHAP settings, as assigned to you by your ISP.
  - Authentication not required by ISP: Make sure that the check box **PPP Authentication** is disabled.
- 11) If you want to use NAT, enable the **NAT** check box (enabled by default) in the **Address Translation** area.
- 12) Set the following values in the **QoS Parameters of Interface** area:
  - a) In the **Bandwidth for Downloads** and **Bandwidth for Uploads** fields, enter the bandwidth in Kbps for downloads and uploads, respectively, as provided by your ISP.
  - b) If you want to use Internet Telephony as well, open the drop-down list **Bandwidth Control for Voice Connections** and select the item **Upload only** or **Upload and Download**, as required. In the field **Bandwidth Used for Voice/Fax (%)**, enter how much bandwidth is to be reserved for voice and fax connections as a percentage value (default value: 80%).
- 13) Click **OK & Next**. You are taken to the **Configure DynDNS-Account** window.
- 14) If you want to use a VPN or remote access and do not have a public static IP address, you will need to have already applied for and set up a DynDNS account (at [dyndns.org](http://dyndns.org), for example).
  - a) If your desired DynDNS provider is included in the **Domain name** drop-down list, select it from that list (e.g., [dyndns.org](http://dyndns.org)).
  - b) If your desired DynDNS provider is not included in the **Domain name** drop-down list, select the **User defined Domain** check box. Enter the desired DynDNS provider in the **Domain name** field and enter the update URL of the DynDNS provider in the **Update URL** field. The structure of

this URL depends on the DynDNS provider. In addition, customer-specific parameters (shown in *italics* in the example) must be supplemented.

```
http://www.anydns.info/  
update.php?user=<username>&password=<pass>&host=<domain>  
&ip=<ipaddr>
```

- c) Enter the **User name** and the **Password** of your DynDNS account.
  - d) Enter the host name assigned to you by the DynDNS provider, omitting the domain name, for instance, myhost, in the **Hostname** field. Your complete domain name would then be myhost.dyndns.org, for example.
  - e) Test the DynDNS account with **Connection test**.
  - f) After the test succeeds, click **OK**.
  - g) Click **OK & Next**.
- 15) If you have a public static IP address or do not want to use a VPN or remote access, click **No DynDNS**.
- 16) Click **Finish**. The communication system performs a restart.

### 9.1.3 WAN port

WANs (**Wide Area Network**) are used to network different LANs (**Local Area Network**) as well as individual PCs with one another. An Internet modem for access to the Internet can be connected to the WAN port.

The WAN port must not be used for the networking of network nodes and for connecting IP stations or IP clients.

### 9.1.4 DynDNS

DynDNS (Dynamic Domain Name Service) is an Internet service that assigns a fixed DNS name to an IP address that changes dynamically.

OpenScape Business X makes the DynDNS service available if an Internet modem is connected to the WAN port of OpenScape Business X and the communication system is used as an Internet router. If this is not the case, DynDNS is set up in the external Internet router in the infrastructure of the customer.

#### DNS Name

With DynDNS, a client who is connected to the Internet with a dynamic IP address can always be addressed with the same name, the DNS name. A DynDNS account with a DynDNS provider (such as www.dyndns.org) is needed for this. If the communication system is assigned a new IP address (for example, by the Internet Service Provider), this IP address is automatically sent to the DynDNS provider and saved in the DynDNS account. The refresh interval is adjustable. If a DNS name is addressed, a request is sent to the DynDNS provider to translate

the name into the IP address currently valid. The entire DNS name (also known as the domain name) is composed of a host name of your choice (myhost, for instance) and the selected DynDNS provider (dyndns.org, for instance), producing, in this instance, myhost.dyndns.org. More information on this can, for example, be found at the Internet address:

<http://www.dyndns.org/services/dyndns>

DynDNS also lets you set up a virtual private network (VPN) over an Internet Service Provider that supplies dynamic IP addresses. This enables teleworkers, for example, to access the internal network via the Internet. More Information can be found under [Virtual Private Network \(VPN\)](#).

### Mail Exchanger

The Mail Exchange entry (MX record) in the Domain Name Service (DNS) specifies the IP address to which e-mails should be sent for the domain name configured (myhost.dyndns.org, for instance). The mail server (Mail Exchanger) must be located at the IP address specified. An e-mail address for this domain name could be as follows: mymail@myhost.dyndns.org.

The Backup MX function buffers e-mails that could not be delivered to the Mail Exchanger specified above (because of temporary unavailability, for instance) and delivers them as soon as Mail Exchanger availability is restored.

## 9.1.4.1 How to Configure the DynDNS Service

### Prerequisites

- You are logged into the WBM with the **Expert** profile.

### Step by Step

- 1) In the navigation bar, click on **Expert Mode**.
- 2) Click **Telephony > Basic Settings** in the navigation tree.
- 3) Click on **DynDNS** in the menu tree.
- 4) Click **Update Timer for DNS Names**.

## Connection to Service Provider Internet Access

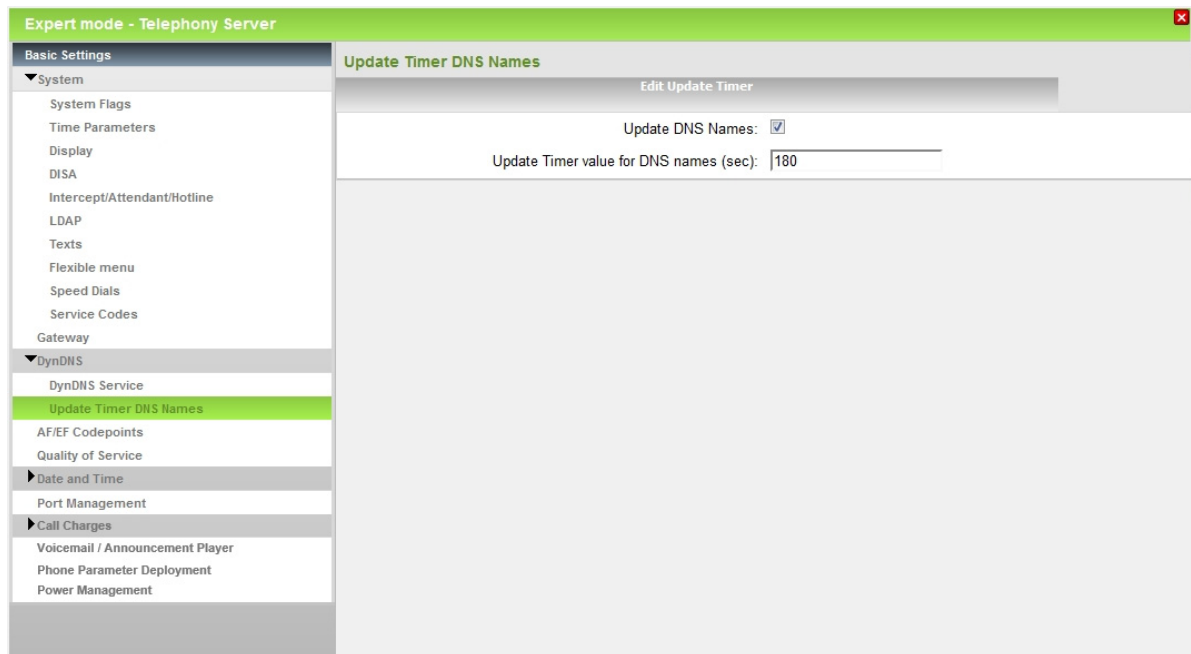

- 5) Activate the radio button **Update DNS Names**.
- 6) This timer value applies only to VPN: in the **Update Timer value for DNS Names** field, enter the time interval (in seconds) after which the VPN component checks whether any DNS names in the VPN configuration are resolved into new IP addresses (VPN with dynamic IP addresses). If this is the case, the VPN will be reconfigured with the new IP addresses.  

The default value for this field is 180, which corresponds to an update interval of 3 minutes.
- 7) In the menu tree, click on **DynDNS Service**.
- 8) Click the **Edit DynDNS Configuration** tab.

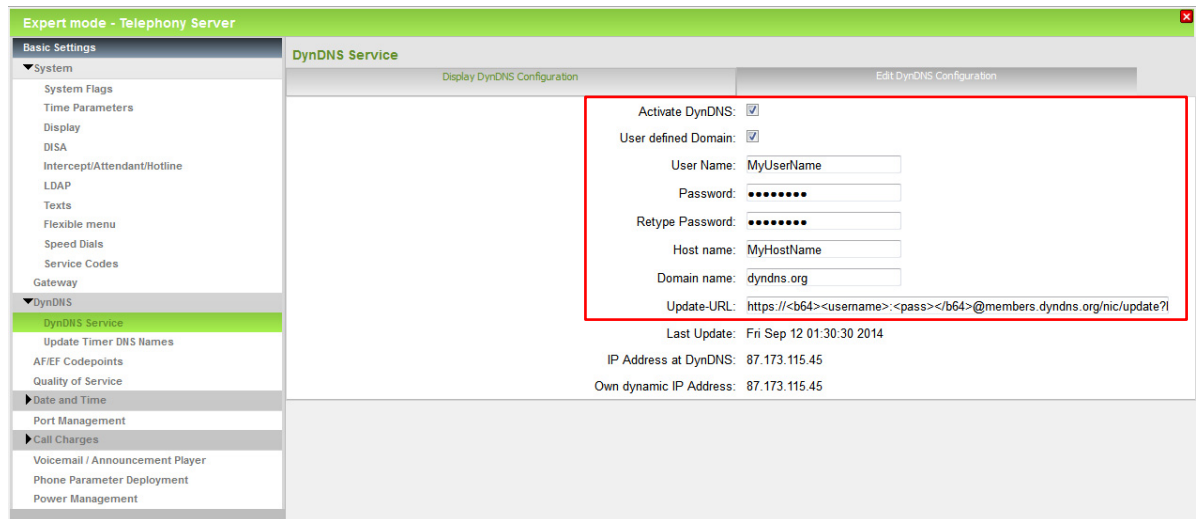

- 9) Select the **Activate DynDNS** check box.
- 10) If your desired DynDNS provider is included in the **Domain name** drop-down list, select it from that list (e.g., dyndns.org).
- 11) If your desired DynDNS provider is not included in the **Domain name** drop-down list, select the **User defined Domain** check box. Enter the desired DynDNS provider in the **Domain name** field and enter the update URL of the DynDNS provider in the **Update URL** field. The structure of this URL depends on the DynDNS provider. In addition, customer-specific parameters (shown in *italics* in the example) must be supplemented.

```
http://www.anydns.info/
update.php?user=<username>&password=<pass>&host=<domain>
&ip=<ipaddr>
```

Example of an update URL with base64-encoded authentication:

```
https://<b64><username>:<pass></b64>@members.dyndns.org/
nic/
update?hostname=<domain>&myip=<ipaddr>&wildcard=NOCHG&mx
=NOCHG&backmx=NOCHG
```

<b64>...</b64> for Base64-encoded parameters

- 12) Enter the user name for your DynDNS account with the DynDNS provider in the **Login Name** field.
- 13) Enter the password of your DynDNS account with the DynDNS provider in the **Password** and **Retype Password** fields.
- 14) Enter the host name assigned to you by the DynDNS provider, omitting the domain name, for instance, myhost, in the **Hostname** field. Your complete domain name would then be myhost.dyndns.org, for example.
- 15) Only visible for DynDNS providers included in the **Domain name** drop-down list: Activate the radio button **Enable Wildcard** if you want queries to a

subordinate domain name such as any.myhost.dyndns.org to also be accepted.

- 16) Only visible for DynDNS providers included in the **Domain name** drop-down list: Activate the radio button **Use HTTPS for Update** if you want to use a secure connection to the DynDNS provider to update the IP address.
- 17) Click **Apply**, followed by **OK**.

### 9.1.4.2 How to Define the Mail Exchanger

#### Prerequisites

- You are logged into the WBM with the **Expert** profile.

#### Step by Step

- 1) In the navigation bar, click on **Expert Mode**.
- 2) Click **Telephony > Basic Settings** in the navigation tree.
- 3) Click on **DynDNS** in the menu tree.
- 4) Click on **DynDNS Service**.
- 5) Click on the **Edit DynDNS Configuration** tab.

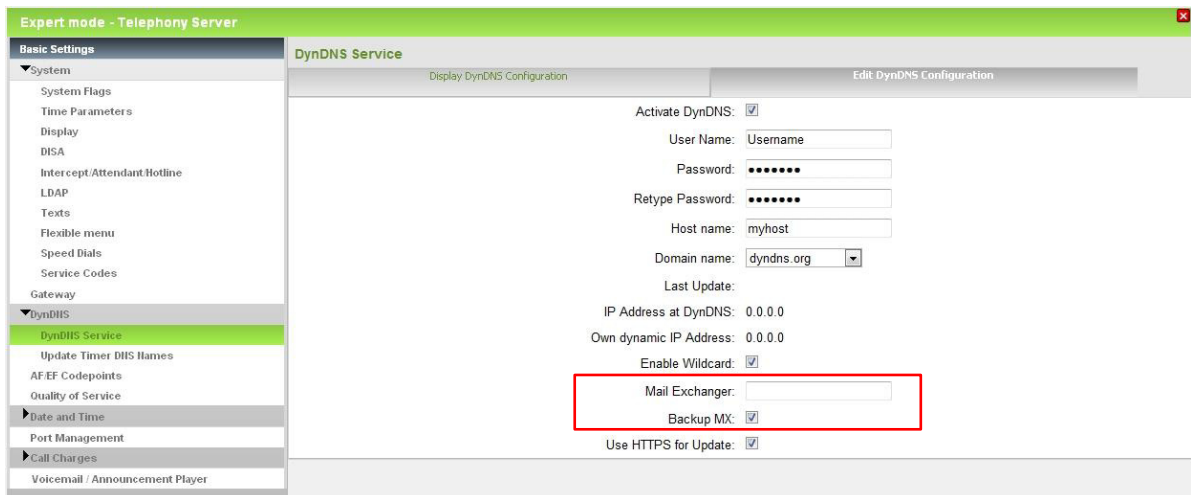

- 6) Enter the IP address of the mail server (Mail Exchange entry or MX record) in the **Mail Exchanger** field.
- 7) If necessary, activate the **Backup MX** radio button.
- 8) Click on **Apply**, followed by **OK**.

## 9.2 CO Access via ITSP

In order to make calls over the Internet, you will need access to an Internet Telephony Service Provider (ITSP, SIP Provider). To do this, an Internet telephony connection and a user account must be applied for from the ITSP.

### Connection to the ITSP

The communication system uses the options described in the section on "Internet Access" to reach the ITSP (OpenScape Business X: via LAN or WAN / OpenScape Business S: exclusively via LAN).

The ITSP access based on SIP (Session Initiation Protocol) for signaling and RTP (Realtime Transport Protocol) for voice and data.

Internet Telephony Service Providers do not always offer the same range of SIP features. Consequently, only ITSPs certified for the communication system should be used. A list of certified ITSPs as well as the certification process can be found at the following link:

[http://wiki.unify.com/wiki/Collaboration\\_with\\_VoIP\\_Providers](http://wiki.unify.com/wiki/Collaboration_with_VoIP_Providers)

---

**INFO:** Special numbers and emergency numbers, which are not supported by the ITSP, should be routed over fixed network connections.

In the event of ITSP failure, fixed network connections via least cost routing (LCR) can be used as a fallback solution.

---

### ITSP user account

The ITSP user account (SIP User Account) must be applied for from the ITSP. The ITSP provides a SIP Registrar server at which the communication system must first log in (provider-specific) for this purpose.

---

**INFO:** A registration is not necessary if static IP authentication or a VPN tunnel is used by the ITSP.

---

### Mobile Extension (MEX)

This feature is offered by some mobile phone operators in connection with the MDA (mobile direct access) service. It enables mobile phones/smartphones to be integrated as internal subscribers in a communication system.

This feature can only be used only with an Internet telephony DID connection. To do this, the MEX number provided by the ITSP must be entered when configuring the ITSP. At the ITSP, the call number of the mobile phone is associated with the MEX number. In addition, the mobile phone or smartphone must be configured in the communication system as a Mobility station (see [Configuring myPortal to go and Mobility Entry](#)).

Short Description:

- The mobile phone operator offers a flat-rate for the mobile phone.
- One Number Service: the mobile phone can be reached under a single fixed network number, which is also communicated to the other party.
- The presence status and connection status of mobile phones are visible exactly as for normal internal subscribers.
- Every phone call from or to the mobile phone is performed exclusively via OpenScape Business in combination with a certified ITSP.
- The mobile phone number of the mobile phone is not known to the outside, i.e., the mobile phone cannot be called directly. It can also not make any direct outbound calls. All calls are conducted through OpenScape Business.
- The mobile phone can be integrated into system-internal teams.
- UC applications such as myPortal for Desktop and myPortal for Outlook can be used in the same way as for internal subscribers. myPortal Smart is currently not supported.
- myPortal to go is available on the road.
- Embedded mobile phones identify themselves by name when calling an internal subscriber.
- The digit analysis and call routing in the system or network occurs as for any other internal station (e.g., allowed numbers, denied numbers, LCR rules)
- The ITSP uses special call signaling from/to the OpenScape Business, which must be administered accordingly.
- Every integrated mobile phone requires a Mobility User license.
- To use UC applications, a UC Client license is additionally required.

## 9.2.1 Configuring an ITSP

It is possible to configure predefined and new Internet Telephony Service Providers (ITSPs). You can configure one or several accounts for each ITSP. Up to 8 ITSPs may be active simultaneously.

Additional information on ITSPs and their features can be found here:

[http://wiki.unify.com/index.php/  
Collaboration\\_with\\_VoIP\\_Providers#Overview](http://wiki.unify.com/index.php/Collaboration_with_VoIP_Providers#Overview)

---

**INFO:** Configuration examples can be found on the Internet at the **Unify Experts Wiki** under *OpenScape Business - SIP / ITSP Connectivity - PDF "OSBiz V2 Configuration for ITSP"*.

---

### Assigning the ITSP Phone Numbers

- In the case of an **Internet Telephony Station Connection**, the ITSP provides individual numbers such as 70005555, 70005556, etc. These individual call numbers are then assigned manually as the internal call numbers of the subscribers.



- In the case of an **Internet telephony point-to-point connection**, the ITSP provides a call number range, e.g., (+49) 89 7007-100 to (+49) 89 7007-147. The call numbers from the range are then assigned manually as the internal call numbers of the subscribers.

These two connection types can be combined as appropriate.

Alternatively, the ITSP phone numbers can be entered as the DID call numbers of the subscriber for both connection types during the station configuration.

Internal call number	Name	DID
100	Andreas Richter	897007100
101	Susanne Mueller	897007101
102	Buddy Miller	897007102
104	Juan Martinez	70005555
105	Emilio Carrara	70005556

The ITSP call numbers thus result from the configured PABX number (e.g., country code 49) and the entered DID numbers in long format. This has advantages for the digit analysis and call management, even in an internetwork. The ITSP connection is thus DID-enabled for another node, for example.

A further CO trunk connection via ISDN is only possible to a limited extent in this case.

### Multisite Management

The subscribers of the communication system can be assigned to different sites (with different area codes, for example). Each site is assigned a route, and each route is assigned an ITSP registration. A maximum of 8 ITSP registrations can be managed. One registration per ITSP is possible or even multiple registrations at one ITSP. Each ITSP registration can be assigned an area code, and multiple subscribers can then be assigned to it. The connection between the subscribers at the different sites and the communication system occurs via a VPN. All sites must be located within one country and use the same CO access code (see also *Networking OpenScape Business in Hosting Environments*, Scenario 1b).

### Using ITSP Templates

The default is to use a preconfigured ITSP template. To do this, the own access data and phone numbers are entered in the template, and this is then activated.

In Expert mode, you can also edit a preconfigured ITSP template and save it as a new template.

### Updating ITSP Templates

The preconfigured ITSP templates are automatically updated after a software update of the system if there are new preconfigured ITSP templates in that update or more recent default values for existing preconfigured templates.

If the ITSP of a template is already activated, the update is not done automatically, since important changes could otherwise be overwritten when updating the default values. Consequently, the update can be performed manually in the

Expert mode if required. The default values will then need to be customized again to suit individual requirements.

#### **Line Direction Mode**

Individual lines of an ITSP trunk can be blocked for outgoing and/or incoming traffic. The following line direction modes are possible:

- outgoing only
- incoming only
- outgoing and incoming (default)

The line direction is evaluated when the communication system must reserve an ITSP line for an incoming or outgoing call.

### **9.2.1.1 How to Configure a Predefined ITSP**

The **Internet Telephony** wizard can be used to configure and activate a predefined Internet Telephony Service Provider (ITSP). You can configure one or several accounts for each ITSP.

#### ***Prerequisites***

- The Internet connection is operational.
- Your ITSP's Internet telephony access data is available (for example, user account, password and Internet telephony number).
- You are logged on to the WBM with the **Advanced** profile.

#### ***Step by Step***

- 1) In the navigation bar, click on **Setup**.
- 2) In the navigation tree, click on **Wizards > Central Telephony**.
- 3) Click **Edit** to start the **Internet Telephony** wizard.
- 4) Clear the **No call via Internet** check box. A country-specific list of the possible ITSPs is displayed. The list contains the predefined ITSPs for the selected country and any already created ITSPs.

Provider configuration and activation for Internet Telephony

No call via Internet:

Country specific view: Germany

Activate Provider		Internet Telephony Service Provider
Add		Other Provider
Edit	<input type="checkbox"/>	1&1
Edit	<input type="checkbox"/>	Arcor
Edit	<input type="checkbox"/>	COLT UK & Europe
Edit	<input type="checkbox"/>	COLT VPN
Edit	<input type="checkbox"/>	Ennit AG
Edit	<input type="checkbox"/>	GMX
Edit	<input type="checkbox"/>	Purtel
Edit	<input type="checkbox"/>	QSC
Edit	<input type="checkbox"/>	Sipgate
Edit	<input type="checkbox"/>	Sipgate Trunking
Edit	<input type="checkbox"/>	Skype Connect
Edit	<input type="checkbox"/>	toplink
Edit	<input type="checkbox"/>	Vodafone Anlagenanschluss

- 5) If you want to change the preset country, select the desired country from the **Country specific view** drop-down list to display the ITSPs that are available for this country.
- 6) If required, click **Display Status** to check which ITSPs have already been activated and which Internet telephony subscribers have already been configured under each ITSP. You can activate a maximum of 8 ITSPs. Click **OK** when finished.
- 7) To configure the predefined ITSP, click **Edit** in the line associated with the desired ITSP.
- 8) Activate the check box **Enable Provider**.
- 9) If the provider supports secure connection, the check box **Secure Trunk** can be activated.
- 10) The values for "**Provider Registrar**", "**Provider Proxy**", "**Provider Outbound Proxy**" and "**Provider Feature**" (if enabled) are predefined according to the needs of most ITSPs. For some ITSPs customer specific server addresses are used. In such a case the fields which are not greyed out needs to be filled according to the documentation received from the ITSP.
- 11) If the provider supports Call deflection the section **Provider Feature** is shown and you can activate the call deflection feature. When Call deflection is activated call forwarding is performed in the provider network, call management in the system is not effective.

## Connection to Service Provider CO Access via ITSP

Setup - Wizards - Central Telephony - Internet Telephony

### Internet Telephony Service Provider

Provider Name: Telekom DeutschlandLAN SIP-Trunk Registered Mode  
Enable Provider:   
Secure Trunk:   
Domain Name:

**Provider Registrar**

Use Registrar:   
IP Address / Host name:   
Port:   
Reregistration Interval at Provider (sec):

**Provider Proxy**

IP Address / Host name:   
Port:

**Provider Outbound Proxy**

Use Outbound Proxy:   
IP Address / Host name:   
Port:

**Provider Feature**

Call deflection:

Help Abort Back OK & Next Delete Data

**12) Click OK & Next.**

**13) Click Add** to configure your ITSP accounts with the corresponding Internet telephony numbers. The fields that will then be displayed are provider-specific.

Setup - Wizards - Central Telephony - Internet Telephony

Internet Telephony Station for Sipgate

Internet telephony station:

Authorization name:

Password:

Confirm Password:

**Call number assignment**

Use public number (DID) ▼

ITSP-multiple route:

Default Number:

**Default Number**  
ITSP as primary CO access  
Enter one of the call numbers supplied by your network provider here. This will be used in outgoing calls as the calling party number in case no other number is available for the respective call.  
All call numbers supplied by your network provider are to be entered within the trunk and telephones configuration (DID field) primary CO access.

Help Abort Back OK & Next Delete Data

- 14)** Enter the credentials for your account in the **Internet Telephony Station** field. You received this data from your ITSP. Depending on the ITSP, different designations are used for this, for example: SIP User, SIP ID, etc.

More details can be found at [http://wiki.unify.com/index.php/Collaboration\\_with\\_VoIP\\_Providers](http://wiki.unify.com/index.php/Collaboration_with_VoIP_Providers)

- 15)** Enter the authorization name in the **Authorization name** field. You received this data from your ITSP. If you have not received any authorization name, enter the same data you entered under **Internet Telephony Station**.

---

**INFO:** If no registration is used, **Authorization name** is grayed out and cannot be configured.

---

- 16)** Enter the password you received from the ITSP in the **New Password** and **Confirm Password** fields. Depending on the ITSP, different designations are used for this, for example: Password, SIP Password, etc.

---

**INFO:** If no registration is used, **Password** is grayed out and cannot be configured.

---

- 17)** Assignment of Internet telephony phone numbers - Option 1:

**Use public number (DID):** the Internet telephony phone numbers (DID) of your Internet telephony connection are configured in the stations setup (in the **DID** fields). No mapping configuration during the ITSP configuration is necessary.

**Connection to Service Provider**  
CO Access via ITSP

Setup - Wizards - Central Telephony - Internet Telephony

Internet Telephony Station for Sipgate

Internet telephony station:

Authorization name:

Password:

Confirm Password:

**Call number assignment**

Use public number (DID) ▼

ITSP-multiple route:

Default Number:

**Default Number**  
ITSP as primary CO access  
Enter one of the call numbers supplied by your network provider here. This will be used in outgoing calls as the calling party number in case no other number is available for the respective call.  
All call numbers supplied by your network provider are to be entered within the trunk and telephones configuration (DID field) primary CO access.

ITSP route prefixes

Add

Enter all prefixes assigned to this ITSP route.

Help Abort Back OK & Next Delete Data

- a) Select the option field **Use public number (DID)** in the **Call number assignment** area.
  - b) Under **Default Number**, enter the phone number to be used for outgoing calls to subscribers who do not have their own phone number.
  - c) If your ITSP supports the "Mobile Extension (MEX)" feature, enter the MEX number provided by the ITSP (8 positions, digits only) under **MEX Number**. If your ITSP does not support the "Mobile Extension (MEX)" feature, the **MEX Number** field is not displayed.
  - d) If multiple routes need to be configured, activate the check box **ITSP-multiple route**.
  - e) Enter the **ITSP route prefixes** assigned to the route and click on **Add**.
- 18) Assignment of Internet telephony phone numbers - Option 2:**

**Use internal number (Callno) / Single entries:** You have an ITSP which needs SIP registration for each call number (e.g. 70005555, 70005556,...). For each call number an Internet Telephony Station must be created and a single call number needs to be assigned. If your ITSP allows multiple call numbers with one registration Option 1 should be used.

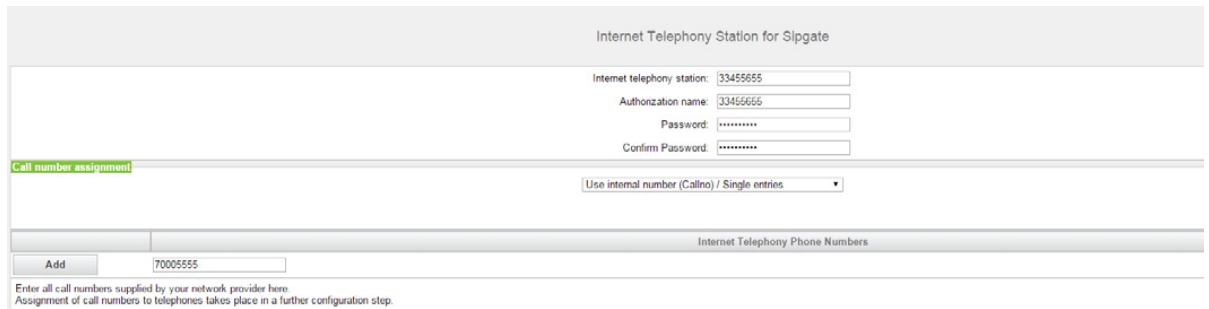

- a) Select the option field **Use internal number (Callno) / Single entries** in the **Call number assignment** area.
- b) In the **Internet Telephony Phone Numbers** area, enter one of the Internet telephony phone numbers provided by the ITSP in the field next to the **Add** button and then click **Add**.
- c) To assign further Internet telephony numbers to the account, repeat step b).

**19) Assignment of Internet telephony phone numbers - Option 3:**

**Use internal number (Callno) / Range entry:** the use of this option is deprecated, for DID configuration option 1 should be used.

You have an Internet telephony point-to-point connection and have received a call number range as Internet telephony phone numbers (e.g., +49) 89 7007-100 to (+49) 89 7007-147. You then assign the call numbers from the call number range as the internal call numbers of the subscribers.



- a) Select the option field **Use internal number (Callno) / Range entry** in the **Call number assignment** area.
- b) Enter the system phone number under **System phone number (prefix)**.
- c) Enter the desired DID number range for the Internet telephony station in the 'from' and 'to' fields after Direct inward dialing band. The range entered by default is 100 - 147.

**20) Click OK & Next.**

**21) If you want to configure additional accounts, repeat steps 13 through 20.**

**22) Click OK & Next.** You will see an overview of which Internet telephony phone numbers are assigned to accounts.

23) Assign one internal station number each to every Internet telephony phone number.

This step is not required if you have selected option 1 for the assignment of the Internet telephony phone numbers. In this case, the assignment is made when the configuring the stations (i.e., the telephones and subscribers) in the **DID** field. The screen is also visible in this case but not editable.

Call Number Assignment for Sipgate			
So that an internal participant or members of a call group can telephone via Internet without an "Internet Telephony Phone Number", the "Internet Telephony Phone Number" must be configured with "Use as PABX number for outgoing calls".			
Name of Internet Telephony Station	Internet Telephony Phone Number	Internal Call Number	Use as PABX number for outgoing calls
33455655	49897007100	100 Andreas Richter	<input checked="" type="radio"/>
33455655	49897007101	101 Susanne Mueller	<input type="radio"/>
33455655	49897007102	102 Buddy Miller	<input type="radio"/>
33455655	49897007103	103 Janet Jones	<input type="radio"/>
33455655	49897007110	110 Natalie Dubois	<input type="radio"/>
33455655	49897007111	111 Pierre Martin	<input type="radio"/>
33455655	49897007112	112 Claudia Ferraro	<input type="radio"/>
33455655	49897007113	113 Giovanni Rossi	<input type="radio"/>
33455655	49897007114	114 Carlos Alvarez	<input type="radio"/>
33455655	49897007115	115 Emilia Gonzales	<input type="radio"/>
33455655	49897007120	120 Isabel Ferreira	<input type="radio"/>
33455655	49897007121	121 Paolo DaSilva	<input type="radio"/>
33455655	49897007122	122 Ivan VanDenBerg	<input type="radio"/>
33455655	49897007123	123 Robert DeJong	<input type="radio"/>

- a) To do this, select an internal call number in the appropriate line from the **Internal Call Number** drop-down list.
- b) If subscribers without Internet telephony phone numbers or members of a call group are to be allowed to make external calls via the Internet, the radio button **Use as PABX number for outgoing calls** must be activated. The radio button can be activated for only one single Internet telephony phone number.

24) Click **OK & Next**. You will again see an overview of the possible ITSPs here. The enabled ITSPs are identified with a check mark in the **Enable Provider** column. With Display Status you can check the connection status. If you are having connection problems with an already activated ITSP, you can register it again with **Restart ITSP** on this page.

25) Click **OK & Next**.

26) Enter the upload speed of your Internet connection in the **Upstream up to (Kbps)** field. Please do not confuse this with the download speed!

---

**INFO:** The number of simultaneous Internet calls permitted is displayed in the **Number of Simultaneous Internet calls** field. If the voice quality deteriorates due to the network load, you will need to reduce the number.

---

27) Click **OK & Next**.

28) Enter the special numbers you want in the **Dialed digits** column.



Special phone numbers		
Special phone number	Dialed digits	Dial over Pr
1	0C112	ISDN
2	0C110	ISDN
3	0C0137Z	ISDN
4	0C0138Z	ISDN
5	0C0900Z	ISDN
6	0C118Z	ISDN
7	0C116116	ISDN
8		ISDN
9		ISDN
10		ISDN
11		ISDN
12		ISDN
13		ISDN
14		ISDN
15		ISDN

The following station number entries are valid:

0 to 9: allowed digits

-: Field separator

X: Any digit from 0 to 9

N: Any digit from 2 to 9

Z: One or more digits to follow up to the end of dialing

C: Simulated dial tone (can be entered up to three times)

**29)** Use the **Dial over Provider** column to specify whether the special number should be dialed via ISDN or an ITSP. Only the active ITSP is displayed.

---

**INFO:** Ensure that emergency numbers can always be dialed. If you want to dial emergency numbers via an Internet Telephony Service Provider, you must make sure that the ITSP supports this feature.

---

**30)** Click **OK & Next**. The status of your ITSP will be displayed.

**31)** Click **Next** followed by **Finish**. Following this step, please run the **CO Trunk ISDN / Analog / ITSP** wizard to set the prioritization for the exchange line seizure (for example: Exchange Line Seizure First over ITSP and Next over ISDN).

### 9.2.1.2 How to Add a New ITSP

The **Internet Telephony** wizard can be used to configure and activate a new Internet Telephony Service Provider (ITSP). You can configure one or several accounts for each ITSP.

**Prerequisites**

- The Internet connection is operational.
- You are logged on to the WBM with the **Advanced** profile.
- The following ITSP-specific Internet access data is available:

Field	Description	Value from ISP
<b>Gateway Domain Name</b>	Gateway Domain Name of the ITSP Usually identical to the host name (e.g., sip-voice.de)	
<b>Provider Registrar</b>		
<b>Use Registrar</b>	Predefined by the ITSP and generally always set (not required for ITSPs which use static IP authentication).	
<b>IP address/Host name</b>	Host name or IP address of the Registrar server (e.g., sip-voice.de).	
<b>Port</b>	Port number of the Registrar server (e.g., 5060).	
<b>Reregistration Interval at Provider (sec)</b>	Interval (in seconds) at which ITSP registration is repeated. The value of the interval must not be 0 and must not be set too high because on repeating the registration at the ITSP, a dropped connection can also be detected, and an alternate route (via ISDN or an alternate Provider) may be selected if required. Default value: 120 seconds.	
<b>Provider Proxy</b>		
<b>IP address/Host name</b>	Host name or IP address of the proxy server (e.g., sip-voice.de). This is usually identical with the Provider Registrar entry.	
<b>Port</b>	Port number of the proxy server (e.g., 5060). This is usually identical with the Provider Registrar port number.	
<b>Provider Feature</b>		
<b>Call deflection</b>	Visible only if the selected Base template support Call deflection	
<b>Provider Outbound Proxy</b>		
<b>Use Outbound Proxy</b>	Only set if the ITSP uses an outbound proxy.	
<b>IP address/Host name</b>	Host name or IP address of the outbound proxy	
<b>Port</b>	Port number of the outbound proxy	
<b>Provider Inbound Proxy</b>		
<b>Use Inbound Proxy</b>	Only set if the ITSP uses a second proxy.	

Field	Description	Value from ISP
<b>IP address/Host name</b>	Host name or IP address of the second proxy	
<b>Port</b>	Port number of the second proxy	
<b>Provider STUN</b>		
<b>Use STUN</b>	Used only if STUN functionality is required. Also enables global STUN mode.	
<b>IP address/Host name</b>	STUN IP address if the ITSP is using a STUN server.	
<b>Port</b>	STUN port number if the ITSP is using a STUN server.	

### Step by Step

- 1) In the navigation bar, click on **Setup**.
- 2) In the navigation tree, click **Wizards > Central Telephony**.
- 3) Click **Edit** to start the **Internet Telephony** wizard.
- 4) Clear the **No call via Internet** check box. A country-specific list of the possible ITSPs is displayed. The list contains the predefined ITSPs for the selected country and any already created ITSPs.
- 5) If required, click **Display Status** to check which ITSPs have already been activated and which Internet telephony subscribers have already been configured under each ITSP. You can activate a maximum of 8 ITSPs. Click **OK** when finished.
- 6) Click **Add** to set up a new ITSP. A configuration window for the new ITSP appears.
- 7) Select a **Base Template** from the drop-down list. This option makes possible to have the same ITSP configured in several routes.
- 8) Assign a name of your choice for the ITSP in the **Provider Name** field.

---

**INFO:** The maximum limit of characters is 10.

---

- 9) Activate the check box **Enable Provider**.
- 10) Enter the values provided by your ITSP in the remaining areas (see table immediately after prerequisites).

---

**INFO:** The values under the "Extended SIP Provider Data" may only be changed by authorized service personnel, in collaboration with Development!

---

- 11) Click **OK & Next**.

- 12) Click **Add** to configure your ITSP accounts with the corresponding Internet telephony numbers. The fields that will then be displayed are provider-specific.

Setup - Wizards - Central Telephony - Internet Telephony

Internet Telephony Station for Sipgate

Internet telephony station:

Authorization name:

Password:

Confirm Password:

Call number assignment

Use public number (DID) ▼

ITSP-multiple route:

Default Number:

**Default Number**  
ITSP as primary CO access  
Enter one of the call numbers supplied by your network provider here. This will be used in outgoing calls as the calling party number in case no other available for the respective call.  
All call numbers supplied by your network provider are to be entered within the trunk and telephones configuration (DID field) primary CO access.

Help Abort Back OK & Next Delete Data

- 13) Enter the credentials for your account in the **Internet Telephony Station** field. You received this data from your ITSP. Depending on the ITSP, different designations are used for this, for example: SIP User, SIP ID, etc.

More details can be found at [http://wiki.unify.com/index.php/Collaboration\\_with\\_VoIP\\_Providers](http://wiki.unify.com/index.php/Collaboration_with_VoIP_Providers)

- 14) Enter the authorization name in the **Authorization name** field. You received this data from your ITSP. If you have not received any authorization name, enter the same data you entered under **Internet Telephony Station**.

- 15) Enter the password you received from the ITSP in the **New Password** and **Confirm Password** fields. Depending on the ITSP, different designations are used for this, for example: Password, SIP Password, etc.

- 16) Assignment of Internet telephony phone numbers - Option 1:

**Use public number (DID):** the Internet telephony phone numbers (DID) of your Internet telephony connection are configured in the stations setup (in the **DID** fields). No mapping configuration during the ITSP configuration is necessary.

Setup - Wizards - Central Telephony - Internet Telephony

Internet Telephony Station for Sipgate

Internet telephony station:

Authorization name:

Password:

Confirm Password:

**Call number assignment**

Use public number (DID)

ITSP-multiple route:

Default Number:

**Default Number**  
ITSP as primary CO access  
Enter one of the call numbers supplied by your network provider here. This will be used in outgoing calls as the calling party number in case available for the respective call.  
All call numbers supplied by your network provider are to be entered within the trunk and telephones configuration (DID field) primary CO a

**ITSP route prefixes**

Add

Enter all prefixes assigned to this ITSP route.

Help Abort Back OK & Next Delete Data

- a) Select the option field **Use public number (DID)** in the **Call number assignment** area.
- b) Under **Default Number**, enter the phone number to be used for outgoing calls to subscribers who do not have their own phone number.
- c) If your ITSP supports the "Mobile Extension (MEX)" feature, enter the MEX number provided by the ITSP (8 positions, digits only) under **MEX Number**.
- d) Activate the check box **ITSP-multiple route**.
- e) Enter the **ITSP route prefixes** assigned to the route and click on **Add**.

---

**INFO:** In order to configure multiple routes the above steps have to be repeated. More information can be found in the Unify wiki at: [http://wiki.unify.com/index.php/Collaboration\\_with\\_VoIP\\_Providers#General\\_Configuration\\_guides](http://wiki.unify.com/index.php/Collaboration_with_VoIP_Providers#General_Configuration_guides)

---

#### 17) Assignment of Internet telephony phone numbers - Option 2:

**Use internal number (Callno) / Single entries:** You have an ITSP which needs SIP registration for each call number (e.g. 70005555, 70005556,...). For each call number an Internet Telephony Station must be created and a

single call number needs to be assigned. If your ITSP allows multiple call numbers with one registration Option 1 should be used.

- a) Select the option field **Use internal number (Callno) / Single entries** in the **Call number assignment** area.
- b) In the **Internet Telephony Phone Numbers** area, enter one of the Internet telephony phone numbers provided by the ITSP in the field next to the **Add** button and then click **Add**.
- c) To assign further Internet telephony numbers to the account, repeat step b).

**18) Assignment of Internet telephony phone numbers - Option 3:**

**Use internal number (Callno) / Range entry:** the use of this option is deprecated, for DID configuration option 1 should be used.

You have an Internet telephony point-to-point connection and have received a call number range as Internet telephony phone numbers (e.g., +49) 89 7007-100 to (+49) 89 7007-147. You then assign the call numbers from the call number range as the internal call numbers of the subscribers.

- a) Select the option field **Use internal number (Callno) / Range entry** in the **Call number assignment** area.
- b) Enter the system phone number under **System phone number (prefix)**.
- c) Enter the desired DID number range for the Internet telephony station in the 'from' and 'to' fields after Direct inward dialing band. The range entered by default is 100 - 147.

**19) Click OK & Next.**

**20) If you want to configure additional accounts, repeat steps 12 through 19.**

**21) Click OK & Next.** You will see an overview of which Internet telephony phone numbers are assigned to accounts.

**22) Assign one internal station number each to every Internet telephony phone number.**

This step is not required if you have selected option 1 for the assignment of the Internet telephony phone numbers. In this case, the assignment is made when the configuring the stations (i.e., the telephones and subscribers) in the **DID** field. The screen is also visible in this case but not editable.

Call Number Assignment for Sipgate			
So that an internal participant or members of a call group can telephone via Internet without an "Internet Telephony Phone Number", the "Internet Telephony Phone Number" must be "Use as PABX number for outgoing calls".			
Name of Internet Telephony Station	Internet Telephony Phone Number	Internal Call Number	Use as PABX number for outgoing calls
33455655	49897007100	100 Andreas Richter	<input checked="" type="radio"/>
33455655	49897007101	101 Susanne Mueller	<input type="radio"/>
33455655	49897007102	102 Buddy Miller	<input type="radio"/>
33455655	49897007103	103 Janet Jones	<input type="radio"/>
33455655	49897007110	110 Natalie Dubois	<input type="radio"/>
33455655	49897007111	111 Pierre Martin	<input type="radio"/>
33455655	49897007112	112 Claudia Ferraro	<input type="radio"/>
33455655	49897007113	113 Giovanni Rossi	<input type="radio"/>
33455655	49897007114	114 Carlos Alvarez	<input type="radio"/>
33455655	49897007115	115 Emilia Gonzales	<input type="radio"/>
33455655	49897007120	120 Isabel Ferreira	<input type="radio"/>
33455655	49897007121	121 Paolo DaSilva	<input type="radio"/>
33455655	49897007122	122 Ivan VanDenBerg	<input type="radio"/>
33455655	49897007123	123 Robert DeJong	<input type="radio"/>

- a) To do this, select an internal call number in the appropriate line from the **Internal Call Number** drop-down list.
- b) If subscribers without Internet telephony phone numbers or members of a call group are to be allowed to make external calls via the Internet, the radio button **Use as PABX number for outgoing calls** must be activated. The radio button can be activated for only one single Internet telephony phone number.

**23) Click OK & Next.** You will again see an overview of the possible ITSPs here. The enabled ITSPs are identified with a check mark in the **Enable Provider** column. With Display Status you can check the connection status. If you are having connection problems with an already activated ITSP, you can register it again with **Restart ITSP** on this page.

**24) Click OK & Next.**

**25) Enter the upload speed of your Internet connection in the Upstream up to (Kbps) field.** Please do not confuse this with the download speed!

---

**INFO:** The number of simultaneous Internet calls permitted is displayed in the **Number of Simultaneous Internet calls** field. If the voice quality deteriorates due to the network load, you will need to reduce the number.

---

**26) Click OK & Next.**

27) Enter the special numbers you want in the **Dialed digits** column.

The following station number entries are valid:

0 to 9: allowed digits

-: Field separator

X: Any digit from 0 to 9

N: Any digit from 2 to 9

Z: One or more digits to follow up to the end of dialing

C: Simulated dial tone (can be entered up to three times)

28) Use the **Dial over Provider** column to specify whether the special number should be dialed via ISDN or an ITSP. Only the active ITSP is displayed.

---

**INFO:** Ensure that emergency numbers can always be dialed. If you want to dial emergency numbers via an Internet Telephony Service Provider, you must make sure that the ITSP supports this feature.

---

29) Click **OK & Next**. The status of your ITSP will be displayed.

30) Click **Next** followed by **Finish**. Following this step, please run the **CO Trunk ISDN / Analog / ITSP** wizard to set the prioritization for the exchange line seizure (for example: Exchange Line Seizure First over ITSP and Next over ISDN).

### 9.2.1.3 How to Configure Multi-Sites over ITSPs

Using the **Multisite Management** wizard, you can define up to 8 sites for the communication system and then assign an ITSP registration and multiple stations to each of them.

#### *Prerequisites*

- There are as many registrations set up at one or more ITSPs as the number of sites to be configured.
- All sites are located within one country.
- You are logged on to the WBM with the **Advanced** profile.

#### *Step by Step*

- 1) In the navigation bar, click on **Setup**.
- 2) In the navigation tree, click on **Wizards > Central Telephony**.
- 3) Click on **Edit** to start the **Multisite Management** wizard.
- 4) Under **Area Code**, enter an area code for each site (incl. a leading zero, e.g., 069 for Frankfurt and 030 for Berlin). Different area codes or even the same area code may be entered.



- 5) Under **Area**, enter a name for each site a name (e.g., the cities matching the area codes, i.e., `Frankfurt` and `Berlin`, for example, or department designations such as `Service` and `Sales` if the area code is the same ).
- 6) Assign a route to each site in the **Dedicated Route** selection list. For each ITSP registration, one route is automatically reserved (up to 8 are possible).
- 7) sites column and click **Save**. Click **OK & Next**.
- 8) Assign the stations and groups to the sites:
  - a) Mark the desired stations and groups.

---

**INFO:** You can search for stations and groups by entering a search term in the **Call no**, **DID** or **Name** search fields and then clicking on the magnifying glass icon. You can display all stations and groups by leaving all search fields empty and then clicking on the magnifying glass icon.

The **Type** option can be used to display all station types (e.g., **SIP Clients** or **System Clients**).

The found stations and groups can be optionally marked individually in the **Selection** column or collectively via the **Select all** check box.

---

- b) Select the desired site under **to Area**.
  - c) Click **Save**.
  - d) Repeat the preceding steps for other sites.
- 9) If required, you can also assign stations and groups of one site to another site:
  - a) To do this, first select the site from which you want to reassign stations and groups to a different site under **Move selection from area**. All stations and groups of the site are displayed.
  - b) Select the desired stations either individually in the **Selection** column or collectively via the **Select all** check box.
  - c) Select the new site under **to Area**.
  - d) Click **Save**.
  - e) Repeat the preceding steps for other sites.
- 10) Click **OK & Next**.

#### 9.2.1.4 How to Save a Preconfigured ITSP Template as a New Template

##### *Prerequisites*

- You are logged into the WBM with the **Expert** profile.

### Step by Step

- 1) In the navigation bar, click on **Expert Mode**.
- 2) In the navigation tree, click on **Telephony > Voice Gateway**.
- 3) In the menu tree, click on **Internet Telephony Service Provider**.
- 4) Click on the **Add Internet Telephony Service Provider** tab.
- 5) Select the desired ITSP template from the **Base Template** list.
- 6) Enter the desired name for the new ITSP template in the **Provider Name** field.
- 7) Edit the values of the template to suit your needs. An explanation of the values can be found under [Voice Gateway > Internet Telephony Service Provider](#).
- 8) Click on **Apply** followed by **OK**.

## 9.2.1.5 How to Customize a Preconfigured ITSP Template

### Prerequisites

- You are logged into the WBM with the **Expert** profile.

### Step by Step

- 1) In the navigation bar, click on **Expert Mode**.
- 2) In the navigation tree, click on **Telephony > Voice Gateway**.
- 3) In the menu tree, click **Internet Telephony Service Provider**.
- 4) Click on the desired ITSP template in the menu tree.
- 5) Click on the **Edit Internet Telephony Service Provider** tab.
- 6) Edit the values of the template to suit your needs. An explanation of the values can be found under [Voice Gateway > Internet Telephony Service Provider](#).

---

**INFO:** You can reset your edited values to the default values of the template with the **Reset Default Values** button. If the ITSP of the template has already been enabled, all accounts of the ITSP are immediately logged off and re-registered with the default values.

---

---

**INFO:** The **Update** button can be used to update the default values in cases where a software update containing more recent default values for this template was performed.

---

- 7) Click on **Apply** followed by **OK**.

## 9.2.1.6 How to Manually Update a Preconfigured ITSP Template

### *Prerequisites*

- The ITSP of this template is enabled.
- You are logged into the WBM with the **Expert** profile.

### *Step by Step*

- 1) In the navigation bar, click on **Expert Mode**.
- 2) In the navigation tree, click on **Telephony > Voice Gateway**.
- 3) In the menu tree, click **Internet Telephony Service Provider**.
- 4) Click on the desired ITSP template in the menu tree.
- 5) Click on the **Edit Internet Telephony Service Provider** tab.
- 6) Make a note of the template values that you have changed as compared to the default values (for example, using a screenshot).
- 7) Click on **Refresh**. The default values of the template are updated if a software update of the system was performed and if there are more recent default values for this template in that update.
- 8) Edit the values of the template again to suit your needs. An explanation of the values can be found under [Voice Gateway > Internet Telephony Service Provider](#).

---

**INFO:** You can reset your edited values to the default values of the template with the **Reset Default Values** button. This causes all accounts of the ITSP to be immediately logged off and re-registered with the default values.

---

- 9) Click on **Apply** followed by **OK**.

## 9.2.2 STUN (Simple Traversal of UDP through NAT)

When operating the communication system behind a NAT router, STUN determines its own public IP address/port (which is required for some ITSPs). The functionality is made available on the Internet on STUN servers, whose addresses must be stored in the configuration of the communication system.

The required STUN mode depends on the ITSP infrastructure and the used Internet router. STUN is not required for ITSPs that resolve NAT traversal using infrastructure components in the provider network such as the session border controller.

The following STUN modes can be set at the communication system:

- **Automatic (Default)**  
If no ITSP is active, STUN is fully disabled. With an active ITSP, STUN determines the used firewall type (NAT type) at system startup and detects IP address changes during runtime. Depending on the detected NAT type, STUN changes certain parameters in SIP messages (NAT traversal).

---

**INFO:** Symmetric NAT is not supported.

---

- **Always**  
STUN is always active, for example. Depending on the detected NAT type, some parameters in SIP messages are adapted.
- **Use static IP**  
The DSL modem or Internet router uses a static a static IP address (public IP address), and the ITSP requires a static IP authentication. The static IP address and port that is used by the modem or router must be specified in addition.
- **Port Preserving router**  
The public IP address is determined using STUN. The port is entered in SIP messages unchanged.

### 9.2.2.1 How to Set the STUN Mode

#### Prerequisites

- You are logged into the WBM with the **Expert** profile.

#### Step by Step

- 1) In the navigation bar, click on **Expert Mode**.
- 2) In the navigation tree, click on **Telephony > Voice Gateway**.
- 3) In the menu tree, click **Internet Telephony Service Provider**.
- 4) Click on the **Edit STUN Configuration** tab.



- 5) Select the desired STUN mode from the **STUN Mode** drop-down list.
- 6) If you have selected the STUN mode **Use static IP**, enter the static IP address and the port of the DSL modem or Internet router under **Public IP Address** and **Public SIP Port**, respectively.
- 7) Click on **Apply**, followed by **OK**.

## 9.3 CO Access over Digital and Analog Lines

The CO Access over ISDN or analog lines connects the hardware platforms with the public network (PSTN).

Wizards are available to facilitate the configuration of an ISDN outside line or analog outside line.

### 9.3.1 Trunks

Trunks connect the hardware platforms with the public network (PSTN). Every trunk must be assigned a route through which different properties can be assigned to the trunk.

By default, all trunks are assigned a seizure code and a route. These assignments can be changed by the administrator.

In the case of an ISDN trunk connection, the trunks are also referred to as B-channels.

#### Trunk code

Using the trunk code, the communication system seizes the specific trunk assigned to that trunk code. The trunk code is also used to program a trunk key or to test a trunk.

#### MSN Allocation

The service provider assigns one or more MSN (Multiple Subscriber Number) to each ISDN point-to-multipoint (PMP) connection. These can be assigned directly to a line.

#### System Phone Numbers

System phone numbers include the international prefix, the country code and area code, and the PABX number or one or more MSNs.

#### ISDN Protocol

The ISDN protocol used depends on the country code. It should only be changed if the PSTN connection explicitly requires some other deviant protocol. Several protocol templates, which can be adapted to individual requirements, are available. The requisite information for this can be obtained from your Service Provider.

#### B Channel Seizure Mode

Individual B channels of an ISDN trunk can be blocked for outgoing and/or incoming traffic.

The following B channel seizure modes are possible:

- outgoing only

- incoming only
- outgoing and incoming (default)

The B channel seizure mode is only evaluated when the communication system must offer a B-channel. The applies in the following situations:

S <sub>2</sub> outgoing:	The communication system must offer a B-channel.
S <sub>2</sub> incoming:	The remote station must offer a B-channel. This B-channel is accepted by the communication system without checking the setting. It is thus of no direct significance.
S <sub>0</sub> outgoing:	Since the communication system does not pre-assign a B-channel (any channel), this setting is of no direct significance.
S <sub>0</sub> incoming:	When the remote station sets up a call without specifying a B-channel, the communication system offers a B-channel, while taking the set B channel seizure mode into account.

### Dialing Method for Analog CO Trunks (MSI)

The dialing method is automatically detected by the communication system whenever the line is seized. For special cases, the dialing method can also be set directly to Dual Tone Multifrequency (DTMF) or Dial Pulsing (DP).

## 9.3.1.1 How to Configure an ISDN Outside Line

Use the **CO Trunk ISDN / Analog / ITSP** wizard to configure the ISDN outside line. Depending on which ports are present for CO trunks in the communication system (ISDN or analog), the wizard goes through different steps.

### Prerequisites

- You are logged on to the WBM with the **Advanced** profile.
- The communication system is connected to an ISDN trunk.

### Step by Step

- 1) In the navigation bar, click on **Setup**.
- 2) In the navigation tree, click **Wizards > Central Telephony**.
- 3) Click on **Edit** to start the **CO Trunk ISDN / Analog / ITSP** wizard. The wizard displays an overview of the box(es), slot(s) and S<sub>0</sub> ports.
- 4) In the **Country Code** field, enter the country code prefix, e.g., 49 for Germany or 1 for the U.S.
- 5) Enter the local area code, e.g., 89 for Munich, in the **Local area code** field.
- 6) For point-to-point connections, enter the system phone number of your trunk connection, e.g., 7007 (your connection number) in the **PABX number** field.

- 7) Change the **International Prefix** field only if required. The applicable values for Germany and the United States are 00 and 011, respectively.

For international calls, the phone number is preceded by the international prefix and the country code, e.g., 00-1 for calls from Germany to the USA and 011-49 for calls from the USA to Germany.

- 8) Click on **OK & Next**.
- 9) Select one of the following connection types for the relevant connection (box, slot and S<sub>0</sub> port):
  - If you want to configure a point-to-point connection, select the **Point-to-point connection** radio button.
  - If you want to configure a point-to-multipoint connection, select the **Point-to-multipoint connection** radio button.
- 10) Click on **OK & Next**.
- 11) If a point-to-multipoint connection is involved, enter the MSN for the relevant connection (box, slot and S<sub>0</sub> port) and click **OK & Next**.
- 12) Leave the setting of the **No call via Internet** check box unchanged and click **Skip**.
- 13) Select the preferred trunk (CO) access in the **First over** drop-down list and then click **OK & Next**.
- 14) Click on **OK & Next** followed by **Finish**.

### 9.3.1.2 How to Configure an Analog Outside Line

Use the **CO Trunk ISDN / Analog / ITSP** wizard to configure the analog outside line.

#### *Prerequisites*

- You are logged on to the WBM with the **Advanced** profile.
- Your communication system is connected to an analog trunk.

#### *Step by Step*

- 1) In the navigation bar, click on **Setup**.
- 2) In the navigation tree, click **Wizards > Central Telephony**.
- 3) Click on **Edit** to start the **CO Trunk ISDN / Analog / ITSP** wizard. The wizard displays an overview of the box(es), slot(s) and analog ports.
- 4) In the **Country Code** field, enter the country code prefix, e.g., 49 for Germany or 1 for the U.S.
- 5) Enter the local area code, e.g., 89 for Munich, in the **Local area code** field.
- 6) For point-to-point connections, enter the system phone number of your trunk connection, e.g., 7007 (your connection number) in the **PABX number** field.

- 7) Change the **International Prefix** field only if required. The applicable values for Germany and the United States are 00 and 011, respectively.  
  
For international calls, the phone number is preceded by the international prefix and the country code, e.g., 00-1 for calls from Germany to the USA and 011-49 for calls from the USA to Germany.
- 8) Click on **OK & Next**.
- 9) Click on **Skip ISDN**.
- 10) Leave the setting of the **No call via Internet** check box unchanged and click **Skip**.
- 11) Select the protocol for displaying the phone number (service provider dependent) from the **Protocol** drop-down list:
  - If you want to use Frequency Shift Keying, select **FSK**.
  - If you want to use Dual Tone Multifrequency (DTMF), select **DTMF**.
  - If you do not want to use station number display (calling line ID), select **None**.
- 12) Click on **OK & Next**.
- 13) Click on **Edit** to configure the properties of the relevant trunk. If required, edit the values for the **Dialing method**, **CO call identification**, **Flash**, **Line Length** and **Flags** and then click **OK**.
- 14) Click on **OK & Next**.
- 15) Click on **Skip** and then, if necessary, on **OK & Next**.
- 16) Select the preferred trunk (CO) access in the **First over** drop-down list and then click **OK & Next**.
- 17) Click on **OK & Next** followed by **Finish**.

### 9.3.1.3 How to Display All Trunks

#### *Prerequisites*

- You are logged into the WBM with the **Expert** profile.

#### *Step by Step*

- 1) In the navigation bar, click on **Expert Mode**.
- 2) In the navigation tree, click **Telephony > Trunks/Routing**.
- 3) Click on **Trunks/Routing > Trunks** in the menu tree. Depending on the configuration of the communication system, all possible trunks, including the trunk code and route, will be displayed.



### 9.3.1.4 How to Display Individual Trunks

#### *Prerequisites*

- You are logged into the WBM with the **Expert** profile.

#### *Step by Step*

- 1) In the navigation bar, click on **Expert Mode**.
- 2) In the navigation tree, click **Telephony > Trunks/Routing**.
- 3) Navigate in the menu tree under **Trunks/Routing > Trunks > ...** to the desired line. The trunk connected to the communication system, including the trunk code and route, will be displayed.
- 4) Click on **OK**.

### 9.3.1.5 How to Change the Trunk Code

#### *Prerequisites*

- You are logged into the WBM with the **Expert** profile.

#### *Step by Step*

- 1) In the navigation bar, click on **Expert Mode**.
- 2) In the navigation tree, click **Telephony > Trunks/Routing**.
- 3) Navigate in the menu tree under **Trunks/Routing > Trunks > ...** to the desired line.
- 4) Click on the **Change Line** tab.
- 5) Enter the desired value in the **Code** field.

---

**INFO:** If no value is entered as the code, this trunk has no trunk code.

---

- 6) Click on **Apply** followed by **OK**.

### 9.3.1.6 How to Assign an MSN to a Trunk

#### *Prerequisites*

- You are logged into the WBM with the **Expert** profile.

#### *Step by Step*

- 1) In the navigation bar, click on **Expert Mode**.
- 2) In the navigation tree, click **Telephony > Trunks / Routing**.

- 3) Click **Trunks/Routing > MSN assign** in the menu tree.
- 4) Click on the entry that you want to edit under **MSN assign** in the menu tree.
- 5) Enter the **MSN**.
- 6) Select the route that you want to assign from the **Trunk** drop-down list.
- 7) Click on **Apply** followed by **OK**.

### 9.3.1.7 ISDN protocol, modify

#### *Prerequisites*

- You are logged into the WBM with the **Expert** profile.

#### *Step by Step*

- 1) In the navigation bar, click on **Expert Mode**.
- 2) In the navigation tree, click **Telephony > Trunks / Routing**.
- 3) Navigate in the menu tree under **Trunks/Routing > Trunks > ...** to the desired port.
- 4) Click on the **Change ISDN Flags** tab.
- 5) Select the desired protocol from the drop-down list in the **Protocol: Description** area.
- 6) Click on **Apply** followed by **OK**.

### 9.3.1.8 How to Change the B Channel Seizure Mode

#### *Prerequisites*

- You are logged into the WBM with the **Expert** profile.

#### *Step by Step*

- 1) In the navigation bar, click on **Expert Mode**.
- 2) In the navigation tree, click **Telephony > Trunks / Routing**.
- 3) Navigate in the menu tree under **Trunks/Routing > Trunks > ...** to the desired port.
- 4) Click on the **Change B-Channel** tab.
- 5) Clear the check boxes for each channel in the **outgoing** and **incoming** columns as desired.
- 6) Click on **Apply** followed by **OK**.

### 9.3.1.9 How to Change the Dialing Method

#### *Prerequisites*

- You are logged into the WBM with the **Expert** profile.

#### *Step by Step*

- 1) In the navigation bar, click on **Expert Mode**.
- 2) In the navigation tree, click **Telephony > Trunks / Routing**.
- 3) Navigate in the menu tree under **Trunks/Routing > Trunks > ...** to the desired port.
- 4) Click on the **Edit MSI Flags** tab.
- 5) Set the dialing method to Dual Tone Multifrequency (DTMF) or Dial Pulsing (DP).
- 6) Click on **Apply** followed by **OK**.

### 9.3.2 Routes

Routes enable trunks (B channels) to be grouped. Separate parameters can be configured for each trunk group (= route).

Each trunk can be assigned to exactly one route. By default, all trunks are assigned to route 1.

For each route, a name and a seizure code can be assigned.

---

**INFO:** Seizure codes only work for outgoing trunk seizures if LCR has not been activated.

---

#### **B Channel Allocation**

The allocation of B channels to different trunk groups is also called B-channel allocation. For ISDN trunk connections with multiple B-channels, e.g., S<sub>2M</sub> ports, it may be useful to allocate B channels to different trunk groups (called B-channel allocation).

For outgoing calls, only B-channels that are included in the trunk group can be selected (e.g., trunk group selected via the seizure code, overflow trunk group or trunk group selected using LCR)

Incoming calls are always accepted, regardless of the trunk group. As a rule, the B-channel offered by the peer is seized. Consequently, the B-channel allocation configured in the system must also be supported on the peer side (system or public network). If this is not the case, the correct allocation of the call to the correct trunk group cannot be guaranteed.

### **Trunk group key**

A subscriber can program a trunk group key on the telephone. One trunk group key is reserved for outbound calls. Calls placed via trunk group keys are subject to COS toll restriction levels and rules.

When a subscriber presses a trunk group key (or dials a seizure code), the communication system seizes an available trunk that is assigned to the appropriate route. The telephone shows the trunk number in the display. If all trunks of the route are seized, the corresponding LED lights up, even in the case of a successful overflow.

### **Overflow Route with LCR Disabled**

For each route, the administrator can also define an overflow route. If all the trunks of a route are busy during a seizure attempt, the search for trunks continues among all trunks in the overflow route. If all the trunks in the overflow route are busy as well, no further overflow occurs.

### **Overflow Route with LCR Enabled**

As part of the LCR configuration, the administrator configure up to 16 entries per route table that are then processed sequentially within the context of an overflow.

### **Type of Seizure**

For an outgoing route seizure, the administrator can specify the criteria to be used by the communication system when searching for an available trunk in the required direction. This is done by defining the type of seizure as follows:

- cyclic:  
after the last outbound seized trunk - search begins at the next higher trunk number, as of the last outgoing trunk reserved for that direction. Consequently, all trunks are used with similar frequency.
- linear:  
always the first free trunk - search begins at the lowest trunk number assigned to that route.

### **Entering a PABX Number, Incoming and Outgoing**

The administrator can configure the PABX number incoming and the PABX number outgoing separately. Thus, the own number for outgoing calls can be represented differently than is needed for accessibility by incoming calls. The portions for the country code, local area code and the PABX number must each be entered separately in this case. Different entries for the PABX number incoming and outgoing require the availability of the "CLIP no screening" feature at the Central Office. If no PABX number outgoing is configured, the communication system always uses the data of the PABX number incoming.

In the case of an incoming seizure on an ISDN line, the communication system truncates the PABX number portion (left-aligned) from the received phone number in accordance with the incoming phone number type (Type Of Number = TON, see table below Caller ID) and interprets the remaining portion as the Direct Inward Dialing number. For call number information to the PSTN, the communication system automatically inserts the outgoing PABX number portion

as the leading portion of the call number in accordance with the configured type of number (TON). In Germany, the PABX number portion must be specified at the trunk connection without the local area code and the intercept code (0).

### Station Number Transmission

The station number that is sent to the PSTN and to the receiver can be composed as follows:

Type Of Number (TON), outgoing	Station number transmitted to the PSTN
Unknown TON = Unknown	only DID number (default setting)
PABX number TON = Subscriber	PABX number + DID number
Local area code TON = National	+ Local area code + PABX number + DID number
Country code TON = International	Country code + Local area code + PABX number + DID number
Internal TON=Internal	Only for networked system: number prefixes may not be added for closed numbering plans. Call number prefixes are suppressed here.

In addition, you can specify which call number information is to be transmitted from the dialing station to the destination station.

Call number type	Call number transmitted to the PSTN
Internal	In this case, only the internal call number is transmitted. If the destination is an external station, either no number is transmitted or only that of the Attendant Console. The internal call number can be displayed when the destination is an internal station.
Direct inward dialing	In this case, only the DID number is transmitted. The internal call number is not provided for display at internal destinations in other nodes. The call number information is sufficient for external destinations.
Internal / DID	This setting is useful for networking purposes. Both the internal call number and the DID call number are transmitted to the destination station. If an internal station is called within the network, the internal call number of the caller can be displayed for this station. If the internal destination station has activated call forwarding to an external destination, for example, a DID number can also be transmitted in this case.

In addition, the desired handling of the route prefix can be configured:

- Incoming call  
The caller's number is supplemented with the seizure code (-> dialable format for callback) or passed through transparently when it is transmitted to the S0 bus. Default: enabled.

- **Outgoing call**  
The display of the dialed phone number on the system telephone occurs with or without the route prefix. Default: enabled.

### **Second CO Code**

A second trunk code (CO code) is defined if the communication system is a subsystem of another communication system or is networked with several other communication systems. It is only relevant for networking routes (route type = PABX). In this case, the second trunk code is the seizure code for the main system. Within a network, the codes for the trunk seizure, the route seizure code(s) and the second CO code must be configured uniformly. The default in Germany is 0.

## **9.3.2.1 How to Change a Route Assignment**

### ***Prerequisites***

- You are logged into the WBM with the **Expert** profile.

### ***Step by Step***

- 1) In the navigation bar, click on **Expert Mode**.
- 2) In the navigation tree, click **Telephony > Trunks/Routing**.
- 3) Navigate in the menu tree under **Trunks/Routing > Trunks > ...** to the desired line.
- 4) Click on the **Change Line** tab.
- 5) Select the route that you want to assign to the trunk from the **Routes** drop-down list.
- 6) Click on **Apply** followed by **OK**.

## **9.3.2.2 How to Change the Route Name**

### ***Prerequisites***

- You are logged into the WBM with the **Expert** profile.

### ***Step by Step***

- 1) In the navigation bar, click on **Expert Mode**.
- 2) In the navigation tree, click **Telephony > Trunks/Routing**.
- 3) Click **Trunks/Routing > Route** in the menu tree.
- 4) Click on the entry that you want to edit under **Route** in the menu tree.
- 5) Enter the desired value in the **Route Name** field.
- 6) Click on **Apply** followed by **OK**.

### 9.3.2.3 How to Change the Seizure Code

#### *Prerequisites*

- You are logged into the WBM with the **Expert** profile.

---

**INFO:** Seizure codes only work if LCR has not been activated.

---

#### *Step by Step*

- 1) In the navigation bar, click on **Expert Mode**.
- 2) In the navigation tree, click **Telephony > Trunks/Routing**.
- 3) Click **Trunks/Routing > Route** in the menu tree.
- 4) Click on the entry that you want to edit under **Route** in the menu tree.
- 5) Enter the desired value in the **Seizure code** field.
- 6) Click on **Apply** followed by **OK**.

### 9.3.2.4 How to Configure an Overflow Route with LCR Disabled

#### *Prerequisites*

- You are logged into the WBM with the **Expert** profile.

#### *Step by Step*

- 1) In the navigation bar, click on **Expert Mode**.
- 2) In the navigation tree, click **Telephony > Trunks / Routing**.
- 3) Click **Trunks / Routing > Route** in the menu tree.
- 4) Click on the entry that you want to edit under **Route** in the menu tree.
- 5) Select the desired item from the **Overflow route** drop-down list.
- 6) Click on **Apply** followed by **OK**.

### 9.3.2.5 How to Configure an Overflow Route with LCR Enabled

When LCR is enabled, overflow treatment is performed by processing the individual entries of an LCR table successively in the context of the LCR configuration (see [LCR \(Least Cost Routing\)](#)).

### 9.3.2.6 How to Configure the Type of Seizure

#### *Prerequisites*

- You are logged into the WBM with the **Expert** profile.

#### *Step by Step*

- 1) In the navigation bar, click on **Expert Mode**.
- 2) In the navigation tree, click **Telephony > Trunks/Routing**.
- 3) Click **Trunks/Routing > Route** in the menu tree.
- 4) Click on the route that you want to edit under **Route** in the menu tree.
- 5) Click on the **Change Routing Parameters** tab.
- 6) In the **Type of seizure** drop-down list, select either **cyclic** or **linear**.
- 7) Click on **Apply** followed by **OK**.

### 9.3.2.7 How to Enter the PABX Number Incoming and Outgoing

#### *Prerequisites*

- You are logged into the WBM with the **Expert** profile.

#### *Step by Step*

- 1) In the navigation bar, click on **Expert Mode**.
- 2) In the navigation tree, click **Telephony > Trunks / Routing**.
- 3) Click **Trunks / Routing > Route** in the menu tree.
- 4) Click on the entry that you want to edit under **Route** in the menu tree.
- 5) In the **PABX number incoming** area, enter the appropriate values without leading zeros in the fields **Country Code**, **Local area code** and **PABX number**.
- 6) In the **PABX number Outgoing** area, enter the appropriate values without leading zeros in the fields **Country Code**, **Local area code** and **PABX number**.
- 7) Select one of the following options:
  - If you want to suppress the station number, enable the **Suppress station number** check box.
  - If you do not want to suppress the station number, leave the **Suppress station number** disabled.
- 8) Click on **Apply** followed by **OK**.



### 9.3.2.8 How to Configure the Format of the Transmitted Call Number

#### *Prerequisites*

- You are logged into the WBM with the **Expert** profile.

#### *Step by Step*

- 1) In the navigation bar, click on **Expert Mode**.
- 2) In the navigation tree, click **Telephony > Trunks/Routing**.
- 3) Click **Trunks/Routing > Route** in the menu tree.
- 4) Click on the route that you want to edit under **Route** in the menu tree.
- 5) Click on the **Change Routing Parameters** tab.
- 6) Select the desired format of the transmitted call number from the **No. and type, outgoing** drop-down list.
- 7) Click on **Apply** followed by **OK**.

### 9.3.2.9 How to Configure the Type of the Transmitted Call Number

#### *Prerequisites*

- You are logged into the WBM with the **Expert** profile.

#### *Step by Step*

- 1) In the navigation bar, click on **Expert Mode**.
- 2) In the navigation tree, click **Telephony > Trunks/Routing**.
- 3) Click **Trunks/Routing > Route** in the menu tree.
- 4) Click on the route that you want to edit under **Route** in the menu tree.
- 5) Click on the **Change Routing Parameters** tab.
- 6) In the **Call number type** drop-down list, select the item **Internal, Direct inward dialing** or **Internal/DID**.
- 7) Click on **Apply** followed by **OK**.

### 9.3.2.10 How to Configure the Direction Prefix

#### *Prerequisites*

- You are logged into the WBM with the **Expert** profile.

### **Step by Step**

- 1) In the navigation bar, click on **Expert Mode**.
- 2) In the navigation tree, click **Telephony > Trunks/Routing**.
- 3) Click **Trunks/Routing > Route** in the menu tree.
- 4) Click on the route that you want to edit under **Route** in the menu tree.
- 5) Click on the **Change Routing Parameters** tab.
- 6) Select one of the following options:
  - If you want the seizure code to be added to the Calling Line ID for inbound calls, select the check box **Add direction prefix incoming** in the **Routing flags** area.
  - If you do not want the seizure code to be added to the Calling Line ID for inbound calls, clear the check box **Add direction prefix incoming** in the **Routing flags** area.
  - If you want the seizure code to be added to the Calling Line ID for outbound calls, select the check box **Add direction prefix outgoing** in the **Routing flags** area.
  - If you do not want the seizure code to be added to the Calling Line ID for outbound calls, clear the check box **Add direction prefix outgoing** in the **Routing flags** area.
- 7) Click on **Apply** followed by **OK**.

## **9.3.2.11 How to Define a Route for Networking and Enter a Second CO Code**

### **Prerequisites**

- You are logged into the WBM with the **Expert** profile.

### **Step by Step**

- 1) In the navigation bar, click on **Expert Mode**.
- 2) In the navigation tree, click **Telephony > Trunks/Routing**.
- 3) Click **Trunks/Routing > Route** in the menu tree.
- 4) Click on the entry that you want to edit under **Route** in the menu tree.
- 5) Enter the desired value in the field **CO code (2nd trunk code)**.
- 6) Click on the **Change Routing Parameters** tab.
- 7) Select the item **PABX** in the **Route type** drop-down list.
- 8) Click on **Apply** followed by **OK**.

### 9.3.3 Dial Tone Monitoring

When setting up a connection over an analog trunk line, the dialed digits can be sent to the Central Office only when a dial tone (audible signal) has been detected. Since the time until the arrival of the dial tone varies depending on the network provider and network state, the arrival of the dial tone can be monitored.

The dial tone monitoring time and the digit dialing time are configured using Manager E.

#### Delay Period for Dial Tone Monitoring

The monitoring of the dial tone can be done immediately or only after a pause. In some cases, additional tones may need to be played back to the subscriber after the line is seized, for example, to inform him or her that call forwarding has been enabled at the Central office. For such cases, a delay period for the dial tone monitoring (Analog trunk seizure, 1-9 seconds) can be programmed. The dialed digits will then be sent to the CO only after this pause.

---

**INFO:** Notes for Brazil:

If the DTMF dialing method is used from analog phone devices in conjunction with analog trunks (TLAx and TML8W) and pulse dialing after the dial tone monitoring, problems may arise with toll restriction when the country code is set to Brazil. In this case, the DTMF signals from the analog devices go directly to the analog trunk lines. All DTMF signals that were dialed before receiving the dial tone are lost. Consequently, for such cases, least cost routing (LCR) must be enabled for the dialing method and toll restriction to operate properly at the device.

---

#### Dial tone monitoring time

This parameter indicates how long the system will wait for the dial tone and is configurable. If no dial tone is detected during the configured dial tone monitoring time, the line is taken out of service. The system checks at cyclical intervals whether the dial tone is once again present. If this is the case, the line in question is put back into operation.

#### Digit dialing time

This parameter defines how many seconds after detection of the dial tone the first dialed digit is to be sent to the Central Office (default setting: 0 s).

#### Analysis of the Second Dial Tone

The communication system can recognize an additional dial tone (2nd dial tone). This is relevant for public network providers who transmit at a second dial tone for international calls, e.g., for Belgium after 00 and for France after 16 or 19. For Germany, this feature is not relevant.

### 9.3.3.1 How to Configure a Delay Period for Dial Tone Monitoring

#### *Prerequisites*

- An analog port with the analog outside line is available.
- You are logged into the WBM with the **Expert** profile.

#### *Step by Step*

- 1) In the navigation bar, click on **Expert Mode**.
- 2) In the navigation tree, click **Telephony > Trunks/Routing**.
- 3) Click **Trunks/Routing > Route** in the menu tree.
- 4) Click on the analog route that you want to edit under **Route** in the menu tree.
- 5) Click on the **Change Routing Parameters** tab.
- 6) If the dial tone monitoring is to take place immediately, enable the radio button **no pause** in the **Analog trunk seizure** area.
- 7) If the dial tone monitoring is to take place only after a delay period, select the delay period in seconds in the **Analog trunk seizure** area.
- 8) Click on **Apply** followed by **OK**.

### 9.3.3.2 How to Configure the Dial Tone Monitoring Time

#### *Prerequisites*

- An analog trunk board is plugged in.

#### *Step by Step*

- 1) Log into Manager E at the admin PC.
- 2) Click on **File | Transmit** in the menu bar.
- 3) Select the **Communication** tab.
- 4) In the **Access** area, enable the appropriate radio button, depending on the type of connection from the admin PC to the communication system.
- 5) Enable the radio button **Read/write CDB** and click on **System -> PC**.
- 6) Click on **OK**. The CDB will be transferred from the communication system to Manager E.
- 7) After the successful transfer, click **OK** and then on **Close**.
- 8) Click in Manager E in the menu tree of the system view on **Settings > System Parameters > Time Parameters**.
- 9) In the list below **Dial tone monitoring time**, set the maximum time to wait for a dial tone under **Base** and **Factor** (default = base 1s, Factor = 10).
- 10) Click on **Apply**.

- 11) Click on **File | Transmit** in the menu bar.
- 12) Select the **Communication** tab.
- 13) Click on **PC > System** followed by **OK**. The settings are transferred to the communication system.
- 14) Then click **OK** and **Close**.

### 9.3.3.3 How to Configure the Digit Dial Time

#### *Prerequisites*

- An analog trunk board is plugged in.

#### *Step by Step*

- 1) Log into Manager E at the admin PC.
- 2) Click on **File | Transmit** in the menu bar.
- 3) Select the **Communication** tab.
- 4) In the **Access** area, enable the appropriate radio button, depending on the type of connection from the admin PC to the communication system.
- 5) Enable the radio button **Read/write CDB** and click on **System -> PC**.
- 6) Click on **OK**. The CDB will be transferred from the communication system to Manager E.
- 7) After the successful transfer, click **OK** and then on **Close**.
- 8) Click in Manager E in the menu tree of the system view on **Settings > System Parameters > Time Parameters**.
- 9) In the list below **Time between HT analysis and dialing of trunk main station interface**, set the time under **Base** and **Factor** to specify how many seconds after the detection of the dial tone, the first dialed digit is to be sent to the Central Office (default: Base = 10 ms, Factor = 0).
- 10) Click on **Apply**.
- 11) Click on **File | Transmit** in the menu bar.
- 12) Select the **Communication** tab.
- 13) Click on **PC > System** followed by **OK**. The settings are transferred to the communication system.
- 14) Then click **OK** and **Close**.

### 9.3.3.4 How to Enable or Disable the Analysis of the Second Dial Tone

#### *Prerequisites*

- An analog port with the analog outside line is available.
- You are logged into the WBM with the **Expert** profile.

#### *Step by Step*

- 1) In the navigation bar, click on **Expert Mode**.
- 2) In the navigation tree, click **Telephony > Trunks/Routing**.
- 3) Click **Trunks/Routing > Route** in the menu tree.
- 4) Click on the analog route that you want to edit under **Route** in the menu tree.
- 5) Click on the **Change Routing Parameters** tab.
- 6) If you want to enable the analysis of the second dial tone, select the **Analysis of second dial tone** check box in the **Routing flags** area.
- 7) If you want to disable the analysis of the second dial tone, clear the **Analysis of second dial tone** check box in the **Routing flags** area.
- 8) Click on **Apply** followed by **OK**.

## 9.4 Prioritizing the Exchange Line Seizure with LCR Enabled

The prioritization for exchange line seizure defines in what order different network providers (ISDN/analog or ITSPs) are selected.

The exchange line seizure normally occurs by dialing the prefix "0". Within this code, different providers are prioritized (depending on what is preset). For example, an outbound call may be first routed via an ITSP and, if the exchange line seizure fails, be then sent via ISDN.

### 9.4.1 How to Prioritize the Seizure of Exchange Lines

The **CO Trunk ISDN / Analog / ITSP** wizard can be used to configure the order in which exchanges lines are seized over ISDN/analog providers and ITSPs.

#### *Prerequisites*

- You are logged on to the WBM with the **Advanced** profile. Different ITSPs have been set up.

#### *Step by Step*

- 1) In the navigation bar, click on **Setup**.
- 2) In the navigation tree, click **Wizards > Central Telephony**.

- 3) Click on **Edit** to start the **CO Trunk ISDN / Analog / ITSP** wizard. The wizard displays an overview of the box(es), slot(s) and analog ports.
- 4) Click on **OK & Next**.
- 5) Continue clicking on **OK & Next** as often as needed until you reach the **Prioritization for Exchange Line Seizure** window.
- 6) In the **Try to get 'Outside line Seizure'** area, select the preferred network provider over which the communication system should first try to obtain a free CO trunk (i.e., an exchange line) from the **First over** drop-down list.
- 7) Then select a second network provider over which the next attempt to seize an exchange line should be made from the **Next over** drop-down list.
- 8) Finally, select a third network provider over which an attempt to seize an exchange line should be made from the following **Next over** drop-down list.
- 9) Click on **OK & Next** followed by **Finish**.

## 10 Stations

A subscriber or station is a communication partner connected to the communication system. In general, every station (apart from virtual stations) is assigned a terminal. A terminal is, for example, a telephone, a PC or fax device. The stations may also be users of the UC Clients.

The following types of stations exist:

- IP stations (also known as IP clients)
- SIP stations (a subset of IP stations)
- UP0 stations
- DECT stations
- ISDN stations
- Analog stations
- Mobility stations (mobile stations, see [Mobility](#))
- Virtual stations

The data of subscribers (name, station number, DID number, e-mail address, etc.) can be imported as an XML file during the initial installation (see [Individual Dial Plan](#)). In addition, the subscriber data can also be exported to an XML file (see [Exporting Subscriber Data](#)).

### Licensing Procedure for Stations

All stations are subject to licensing. To begin with, stations can be set up during the initial installation or later by using the Station wizards. After a successful setup, the subscribers can make internal calls. In the next step, the station licenses must be activated and assigned to the stations. Once the licenses have been assigned successfully, the subscribers can also make external calls.

---

### Related Topics

- [Licensing](#)
- [Mobility](#)

## 10.1 Dial Plan

A dial plan, which is also called a numbering plan, is a list of all phone numbers and codes available in the communication system. It includes, among other things, the internal call numbers, DID numbers and group call numbers. In the communication system, the call numbers and codes are preset with default values. However, these values can be adapted to suit individual requirements as needed.

When setting up call numbers or codes, error messages may be produced if the desired number is already being used. The dial plan can be used to check which call numbers can still be assigned.



## 10.1.1 Default Dial Plan

The default dial plan includes all call numbers and codes that are predefined in the communication system with default values.

These default values can be edited as necessary. Some numbers can be also deleted completely so that they no longer appear in a dial plan overview.

Default dial plan for the hardware platforms and the softswitch:

Type of call numbers	X1	X3/X5/X8/S	Action
Internal station numbers	11-30	100-742	deletable
User direct inward dialing numbers	11 -30	100-742	deletable
Group call numbers 1-90	31-40	350-439	deletable
Group call numbers 91-800	-	not preset	
Trunk station number	700-703	from 7801 onward	deletable
Seizure codes (external codes):			only editable
Trk. Grp 1 (trunk: ISDN, analog)	0 = World / 9 = USA	0 = World / 9 = USA	
Rte. 8 (UC Suite)	-	851	
Trk. Grp 12-15 (trunk: ITSP)	not preset	855-858	
Rte. 16 (Networking)	not preset	859	
Attendant code (Intercept position), Internal	9 = World 0 = USA	9 = World 0 = USA	only editable
Attendant code (Intercept position), Direct inward dialing	0 = ROW - = USA	0 = ROW - = USA	only editable
Station numbers for online users	not preset	749	only editable
Call number for remote access	not preset	not preset	only editable
Call number for voicemail			
UC Smart	351	351	only editable
UC Suite	-	not preset	only editable
Conference call numbers	-	not preset	only editable
Call number for parking	-	not preset	only editable
AutoAttendant numbers	-	not preset	only editable
Station number for Attendant Console	9 = World 0 = USA	9 = World 0 = USA	only editable
Substitution for "#" (for service codes)	75	75	deletable
Substitution for "#" (for service codes)	76	76	deletable
Service codes			only editable

## 10.1.2 Individual Dial Plan

The communication system allows you to set up an individual dial plan by editing the default values of the call numbers and codes. A reload of the communication system resets the values to the defaults.

The following actions are useful for this purpose:

- Delete defaults: apart from some exceptions (special default numbers), default call numbers can be deleted. These call numbers are identified as "deletable" in the "Action" column of the default dial plan table.
- Edit special defaults: these call numbers must not be deleted. However, their values may be edited. These call numbers are identified as "only editable" in the "Action" column of the default dial plan table.
- Import call numbers and station data: station data can be imported via an XML file during the initial installation. The call numbers and DID numbers of the stations are imported as well. This is usually performed during the initial installation.

### Importing Station Data via an XML File

An individual dial plan can be imported into the communication system via an XML file in UTF-8 format during the initial installation.

The OpenScope Business Assistant administration program makes the file `csv-templates.zip` available under **Service Center > Documents > CSV Templates**. This zip file contains, among other things, the following files, including descriptions:

- `portdata_xml_import_empty.xml`  
This template contains registers without sample records. New records can be entered using Microsoft Excel, for example.
- `portdata_xml_import_example.xml`  
This template contains registers with sample records. These records can be edited using Microsoft Excel, for example. Data records that are no longer needed should be deleted.
- `portdata_xml_import_syntax.txt`  
Descriptions in German and English on how to create records correctly.

### 10.1.2.1 How to Delete or Edit Default Phone Numbers

You can delete some of the default call numbers and then redefine them via the wizards. For special default call numbers, you can edit and change the default values.

#### *Prerequisites*

- You are logged on to the WBM with the **Advanced** profile.

### Step by Step

- 1) In the navigation bar, click on **Setup**.
- 2) Click on **Edit** to start the **Basic Installation** wizard.
- 3) Click on **Next**.

---

**INFO:** You can have an overview of all configured station numbers displayed by enabling the radio button **Display station configuration** and then clicking **Execute function**.

---

- 4) Enable the radio button **Delete All station call numbers**.
- 5) Enable the check box **Delete all station call numbers** in the confirmation prompt.
- 6) Click on **Execute function**.

Change preconfigured call and functional numbers

• Please keep in mind, that these numbers are not available for station or group dialing use.

Preconfiguration for Internet Telephony	<input type="text" value="855"/>	<input type="text" value="856"/>	<input type="text" value="857"/>	<input type="text" value="858"/>
Integrated Voicemail call number (IVM)	<input type="text" value="350"/>			
Voicemail call number (Smart VM)	<input type="text" value="351"/>			
Autoattendant call number (Smart VM)	<input type="text" value="352"/>			
Attendant code	<input type="text" value="9"/>			
Remote Admin call number	<input type="text" value="-"/>			
Licensing call number	<input type="text" value="-"/>			

- 7) Edit the default values in the fields of the special default call numbers if required.
- 8) Click on **OK**. The call numbers are deleted, and any other changes made to the special default call numbers are applied.
- 9) Click on **Abort** to end the **Basic Installation** wizard.

## 10.1.2.2 How to Edit Special Default Call Numbers

You can change the predefined call numbers for special functions.

### Prerequisites

- You are logged on to the WBM with the **Advanced** profile.

### Step by Step

- 1) In the navigation bar, click on **Setup**.
- 2) Click on **Edit** to start the **Basic Installation** wizard.
- 3) Click on **Next**.

---

**INFO:** You can have an overview of all configured station numbers displayed by enabling the radio button **Display station configuration** and then clicking **Execute function**.

---

- 4) Enable the radio button **Change pre-configured call and functional numbers**.
- 5) Click on **Execute function**.

Change preconfigured call and functional numbers				
• Please keep in mind, that these numbers are not available for station or group dialing use.				
Preconfiguration for Internet Telephony	855	856	857	858
Integrated Voicemail call number (IVM)	350			
Voicemail call number (Smart VM)	351			
Autoattendant call number (Smart VM)	352			
Attendant code	9			
Remote Admin call number	-			
Licensing call number	-			

- 6) Enter the desired call numbers and codes in the fields and click **OK**. The new call numbers and codes are saved.

---

**INFO:** Note that the call numbers configured here cannot be assigned as station numbers, DID numbers or group call numbers.

---

- 7) Click on **Cancel** to end the **Basic Installation** wizard.

### 10.1.2.3 How to Import Call Numbers and Station Data

You can import predefined station data via an XML file you created earlier.

#### **Prerequisites**

- You are logged on to the WBM with the **Advanced** profile.
- An XML file with the entered data is available in UTF-8 format. An XML template can be found under **Service Center > Documents > CSV Templates**.

#### **Step by Step**

- 1) In the navigation bar, click on **Setup**.
- 2) Click on **Edit** to start the **Basic Installation** wizard.
- 3) Click **Next**.

---

**INFO:** You can have an overview of all configured station numbers displayed by enabling the radio button **Display station configuration** and then clicking **Execute function**.

---

- 4) Enable the radio button **Import XML file with station data**.
- 5) Click on **Execute function**.
- 6) Use **Browse** to select the created XML file and click **Open**.
- 7) Click **OK** when finished. The station data is imported.
- 8) Click **Cancel** to end the **Basic Installation** wizard.

## 10.2 LAN Telephony Requirements

The term LAN telephony refers to the communication between IP stations in an internal network (LAN). To ensure the quality of the voice transmission in LAN telephony, the IP networks being used and the communication system must meet certain requirements. The voice quality and voice communication reliability always depend on the network technology in use.

To guarantee loss-free transmission and good voice quality, voice signals are digitized using audio codecs and marked using special procedures (Quality of Service) so that voice transmission has priority over data.

### Requirements

- LAN with at least 100 Mbps and full duplex
- Every component in the IP network must be connected to a separate port on a switch or to a router; a hub should not be used.
- Not more than 50 msec delay in one direction (One Way Delay); not more than 150 msec total delay
- Max. 3% packet loss; if a fax/modem via G.711 is used, the packet loss must not exceed 0.05%.
- Not more than 20 msec jitter
- Support for Quality of Service (QoS): IEEE 802.p, DiffServ (RFC 2474) or ToS (RFC 791)
- Maximum 40% network load

### 10.2.1 Audio Codecs

An audio codec is a program that encodes and decodes voice in digital data packets (IP packets). The data compression rate can vary depending on the audio codec used. The bandwidth requirement for transferring an IP packet is lower if the packet is compressed. The decoding of data packets can, however, have a negative impact on voice quality and the playback continuity.

The recipient and sender must use the same codec to ensure that the data can be correctly decoded back into voice after transport.

### **Supported Audio Codecs**

The following audio codecs are supported:

- G.729A, G.729AB: voice encoding at 8 Kbps - good voice quality.
- G.711 (A-law and  $\mu$ -law): voice encoding at 56 or 64 Kbps - very high voice quality. G.711 is also used in fixed networks (ISDN).

The audio codecs can be assigned priorities between 1 (high) and 4 (low). The communication automatically tries to use the audio codec with the highest priority available for every connection. Using an audio codec with low voice compression (good voice quality) increases network load. In the case of intensive IP telephony, this can lead to diminished voice quality in a network already overloaded by data transfers.

The communication system can enable voice activity detection (VAD) for certain codecs. This can reduce network load during long voice pauses.

You can specify a frame size (IP packet size) of 10 to 90 msec for every codec. This specifies the sampling rate at which the audio codec splits the voice signal into IP packets. While a higher value (90 msec, for instance) results in a better relationship between payload and the IP packet overhead, it also increases the transfer delay.

It is possible to disable the resource-hungry G.729 codecs and to only use the G.711 codecs. This optimizes the number of possible simultaneous calls. If this function is enabled, the system must be restarted.

## **10.2.1.1 How to Configure Audio Codec Parameters**

### ***Prerequisites***

- You are logged into the WBM with the **Expert** profile.

### ***Step by Step***

- 1)** In the navigation bar, click on **Expert Mode**.
- 2)** In the navigation tree, click **Telephony > Voice Gateway**.
- 3)** In the menu tree, click **Codec Parameters**.

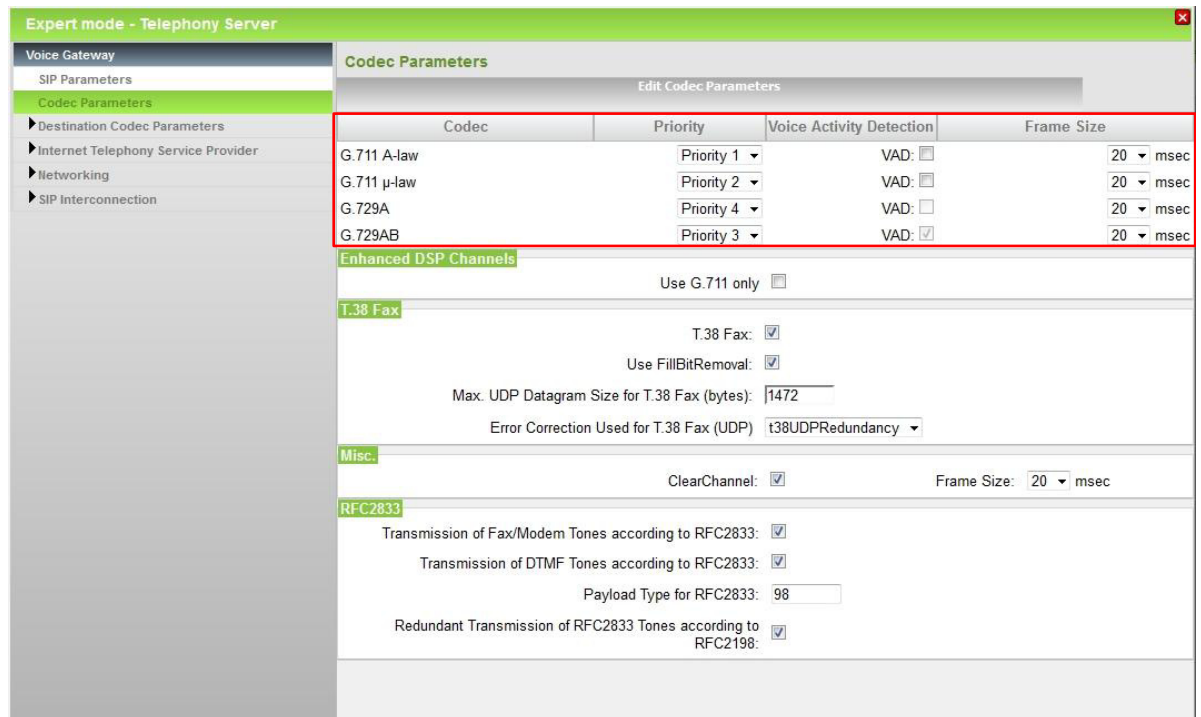

- 4) Assign priority 1 (high) through 4 (low) to the required audio codecs via the **Priority** drop-down list.
- 5) Activate or deactivate the radio button **Voice Activity Detection (VAD)** for the desired audio codecs.
- 6) Use the **Frame Size** field for the desired audio codecs to define the frame size into which the audio codec splits the IP voice packets.

---

**INFO:** You must enter the same value for all codecs, e.g. 20 msec. It is not supported to configure different values for each codec.

---

- 7) If you want to use only the two G.711 audio codecs, select the **Use G.711 only** check box in the **Enhanced DSP Channels** area.
- 8) Click on **Apply**, followed by **OK**.

### 10.2.1.2 How to Assign Audio Codec Parameters to a Destination

#### Prerequisites

- You are logged into the WBM with the **Expert** profile.

#### Step by Step

- 1) In the navigation bar, click on **Expert Mode**.
- 2) In the navigation tree, click **Telephony > Voice Gateway**.

3) In the menu tree, click **Destination Codec Parameters**.

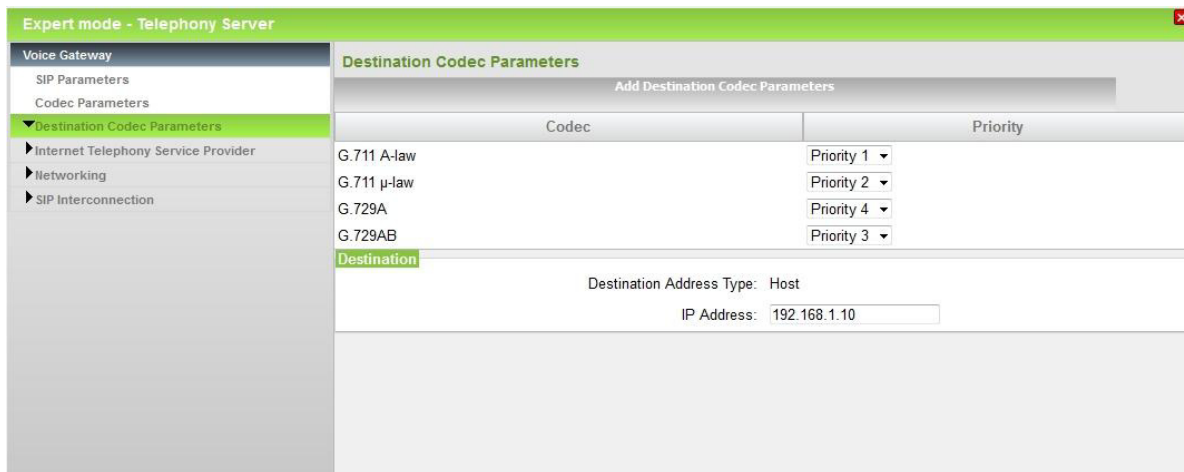

- 4) Assign priority 1 (high) through 4 (low) to the required audio codecs via the **Priority** drop-down list.
- 5) Under **IP address**, enter the IP address of the destination to which the previously set priorities of the audio codec are to be assigned (for example, 192.168.1.10).
- 6) Click on **Apply** followed by **OK**.

## 10.2.2 Transmission of Tones According to RFC 2833

The transmission of DTMF tones and fax/modem tones according to RFC 2833 can be enabled or disabled.

### 10.2.2.1 How to Enable or Disable Transmission of Fax/Modem Tones According to RFC2833

#### *Prerequisites*

- You are logged into the WBM with the **Expert** profile.

#### *Step by Step*

- 1) In the navigation bar, click on **Expert Mode**.
- 2) In the navigation tree, click **Telephony > Voice Gateway**.
- 3) In the menu tree, click **Codec Parameters**.



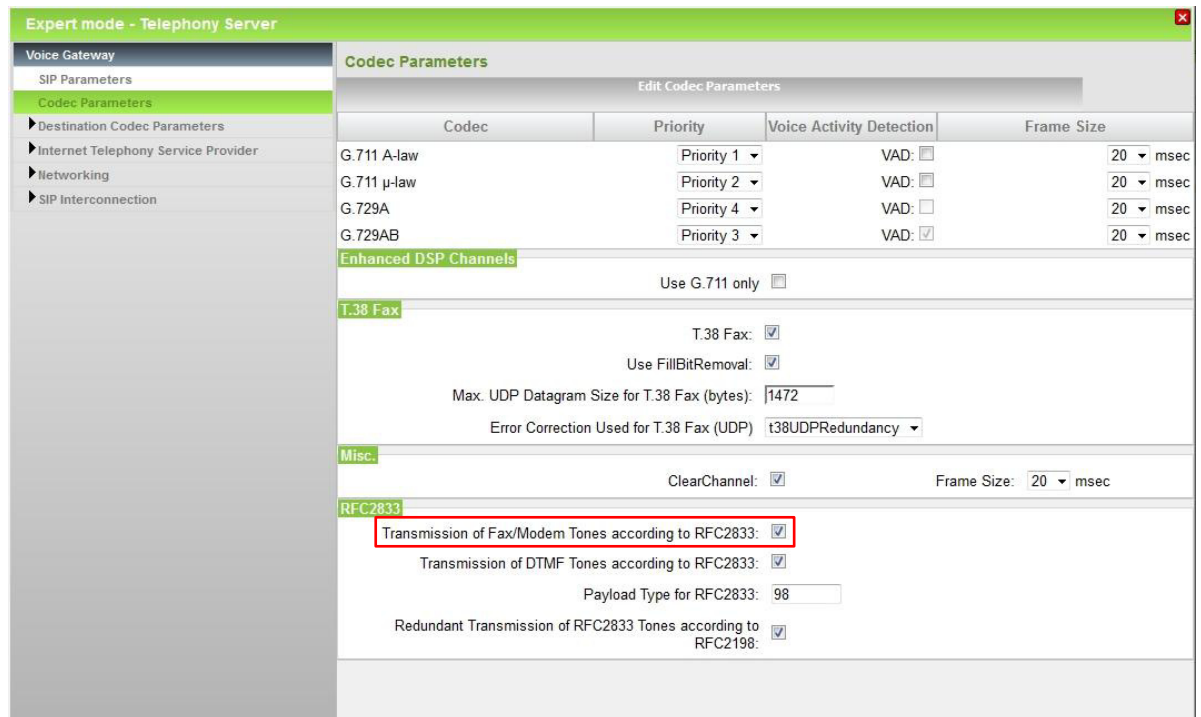

- 4) Select one of the following options:
  - If you want to enable the function, select the **Transmission of Fax/Modem Tones according to RFC2833** check box.
  - If you want to disable the function, clear the **Transmission of Fax/Modem Tones according to RFC2833** check box.
- 5) Click on **Apply** followed by **OK**.

### 10.2.2.2 How to Enable or Disable Transmission of DTMF Tones According to RFC2833

#### Prerequisites

- You are logged into the WBM with the **Expert** profile.

#### Step by Step

- 1) In the navigation bar, click on **Expert Mode**.
- 2) In the navigation tree, click **Telephony > Voice Gateway**.
- 3) In the menu tree, click **Codec Parameters**.

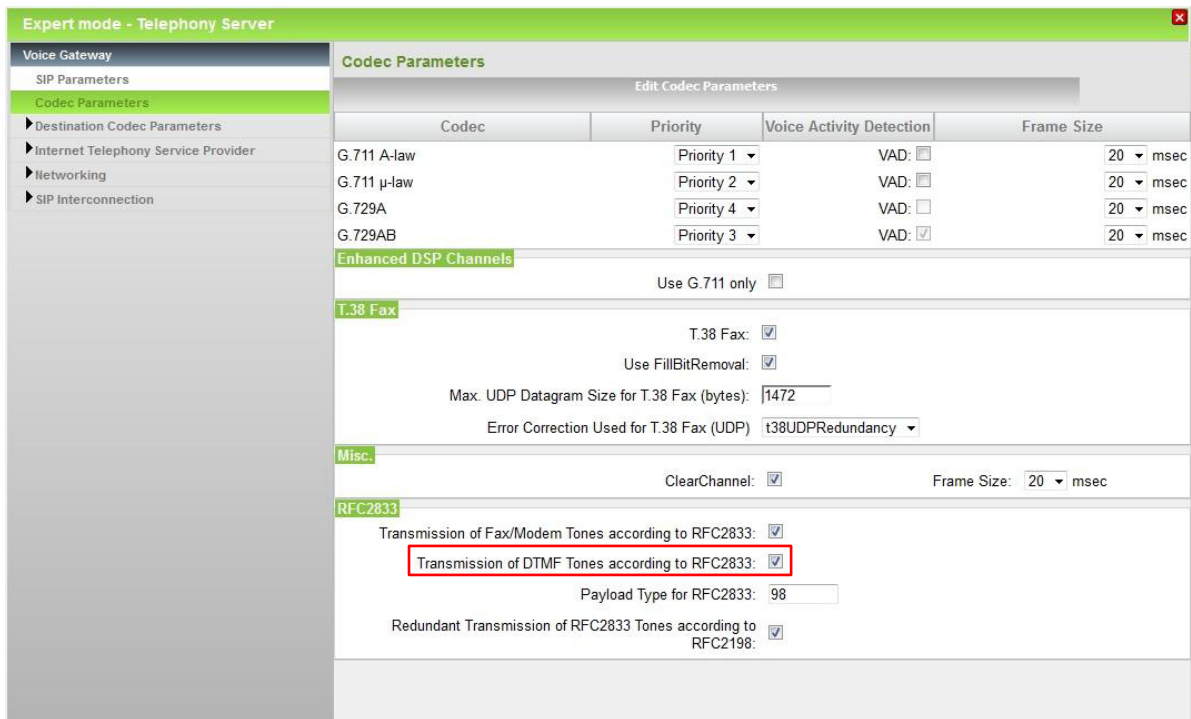

- 4) Select one of the following options:
  - If you want to enable the function, select the **Transmission of DTMF Tones according to RFC2833** check box.
  - If you want to disable the function, clear the **Transmission of DTMF Tones according to RFC2833** check box.
- 5) Click on **Apply** followed by **OK**.

## 10.2.3 Quality of Service

Quality of Service (QoS) encompasses various procedures for guaranteeing the highest possible quality and integrity during the transmission of data packets (IP packets). For good voice quality during voice transmission, QoS is used in the IP network to give IP voice packets priority over IP data packets from other applications.

The IP packets are assigned a special marker (code point) for prioritization. Categorization in different classes is performed based on priority information. If the components available in the IP network (communication system, SIP stations, and Internet routers, for instance) support QoS, you can assign different bandwidth to these classes and thus transport the IP voice packets first.

### Priority Classes According to DiffServ

For DiffServ-based prioritization, different code points are defined for the Type of Service (ToS) field so that IP-packet transmission can be split into different classes.

- Expedited Forwarding (EF) Code point: guarantees constant bandwidth. The bandwidth is always the same for IP packets marked with this code point. Once the set value is reached, all IP packets that exceed this bandwidth are dropped.
- Assured Forwarding (AF) Code point: guarantees minimum bandwidth. IP packets that are marked with this code point have a lower priority than EF and must share the bandwidth not used by EF. Once the set value is reached, all IP packets that exceed this bandwidth are rejected.  
Four classes are reserved for AF: AF1x (low priority), AF2x, AF3x and AF4x (high priority), where "x" stands for one of three dropping levels: low (1), medium (2) and high (3). In the case of "low", packets are buffered over an extended period, in the case of "high", packets are promptly rejected if they cannot be forwarded.
- Best Effort (BE): Unmarked IP packets (Type of Service (ToS) field=00) are handled in the same way as the lowest priority.

### Priority Classes According to IP Precedence

In addition to the DiffServ method, there are several older definitions, which perform the prioritization based on the ToS field. To achieve the best possible adaptation of the communication system to any required settings in the customer network, classes 3 to 7 (CS3-CS7) can be selected for IP Precedence, for example.

### Individual Priority Classes

If none of the preset options is used in the customer network, the ToS value can also be set directly and manually. The set value is set to decimal 0-63 and transferred to the upper 6 bits of the ToS byte (e.g., 41 = 101-001-00 = 0xA4).

**Table of Possible Priority Classes**

Priority class	ToS value, binary	ToS value, hexadecimal
<b>AF (Assured Forwarding)</b>		
AF11	001-010-00	28
AF12	001-100-00	30
AF13	001-110-00	38
AF21	010-010-00	48
AF22	010-100-00	50
AF23	010-110-00	58
AF31	011-010-00	68
AF32	011-100-00	70
AF33	011-110-00	78
AF41	100-010-00	88
AF42	100-100-00	90
AF43	100-110-00	98

Priority class	ToS value, binary	ToS value, hexadecimal
<b>EF (Expedited Forwarding)</b>		
EF	101-110-00	B8
<b>Best Effort (BE)</b>		
BE	000-000-00	00
<b>CS (Class Selector)</b>		
CS3	011-000-00	60
CS4	100-000-00	80
CS5	101-000-00	A0
CS6	110-000-00	C0
CS7	111-000-00	E0
<b>Manual entry</b>	xxx-xxx-00	0-63 (decimal)

### 10.2.3.1 How to Configure Quality of Service (QoS)

#### Prerequisites

- You are logged into the WBM with the **Expert** profile.

#### Step by Step

- 1) In the navigation bar, click on **Expert Mode**.
- 2) Click **Telephony > Basic Settings** in the navigation tree.
- 3) In the menu tree, click **Quality of Service**.

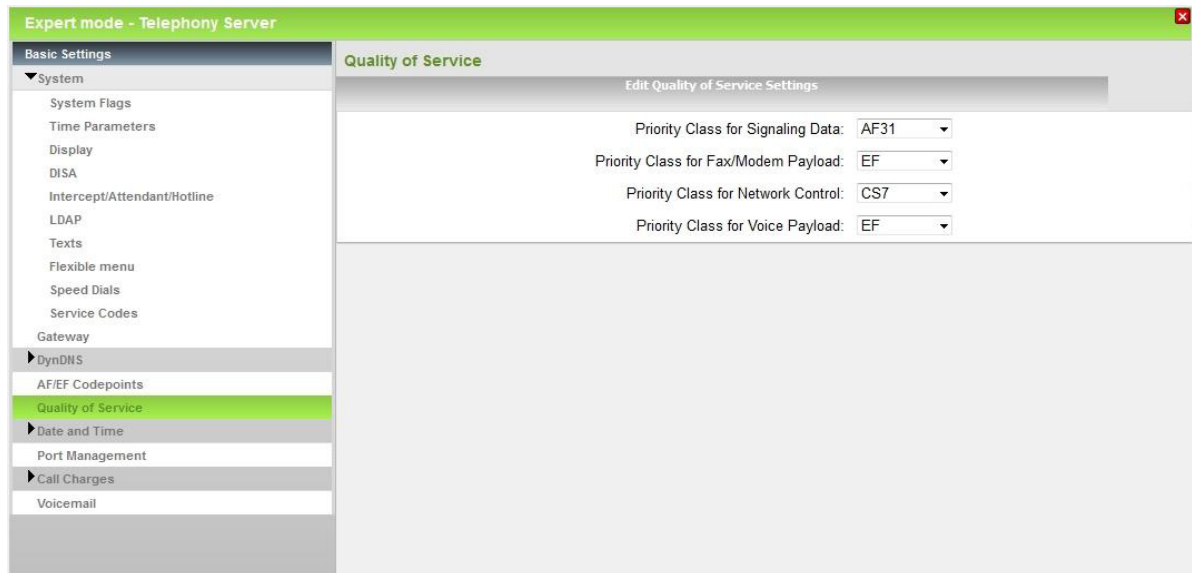

- 4) Select the priority class you want in the **Priority Class for Signaling Data** drop-down list.

- 5) Select the priority class you want in the **Priority Class for Fax/Modem Payload** drop-down list.
- 6) Select the priority class you want in the **Priority Class for Network Control** drop-down list.
- 7) Select the priority class you want in the **Priority Class for Voice Payload** drop-down list.
- 8) Click on **Apply**, followed by **OK**.

## 10.3 IP Stations

IP stations are connected to the communication system via the LAN. An IP station is generally a LAN or WLAN phone.

The following IP protocols are supported:

- **Vendor-specific communication system protocol**  
The communication system uses CorNet-IP (CorNet Internet Protocol) for LAN telephony within the internal network. CorNet-IP, which was developed on the basis of H.323, supports all telephone features of the communication system.
- **SIP (Session Initiation Protocol)**  
SIP is usually used in Internet telephony but is not restricted to it. It can also be used for telephony in the internal network, for example. However, SIP does not support all telephony features associated with the communication system.

The following types of IP stations exist:

- **System Client:** A system client is an IP station that can use all the features of the communication system via CorNet-IP. This can be an IP system phone such as an OpenStage 60 HFA, for instance, or a PC with CTI software such as OpenScape Personal Edition.
- **SIP client:** A SIP client is an IP station that uses the SIP protocol. It can access only limited functionality of the communication system via SIP. A SIP client is a SIP phone such as the OpenStage 15 S, for example.
- **Deskshare User:** A Deskshare User is an IP user who can log in at another IP system telephone (mobile login) and then use this phone as his or her own phone (including the call number).
- **RAS User:** A RAS user (Remote Access Service user) is granted access to the IP network via the ISDN connection. This allows the communication system to be maintained remotely.

For each connected IP station, an "IP User" station license is required.

Two IP stations are reserved for the Online User and for remote access via ISDN. These IP stations do not require a station license. If one or several of these three reserved IP stations are not required, these stations can be converted to normal IP stations in Expert mode. However, station licenses are then required for these IP stations.

### Configuring IP Stations

The following configurations can be performed for an IP station:

- Configuration of standard parameters with the IP Telephones wizard (see [How to Configure IP Stations](#)).
- Configuration of all parameters (standard and advanced parameters in Expert mode (see [Station > Station > IP Clients](#))).

OpenScape Desk Phone IP system phones are supplied with the SIP software by default. As soon as an OpenScape Desk Phone IP system phone is configured in the WBM as a **System Client**, the HFA software stored in the communication system is automatically loaded onto the IP system phone.

## 10.4 SIP Stations

SIP stations are IP stations that use the Session Initiation Protocol (SIP) for communication. SIP stations can use this protocol to access a limited number of the communication system's functions. SIP stations, like IP stations, are connected to the communication system over the LAN.

A SIP station is a WLAN phone or a LAN phone such as the OpenStage 15 S, for example.

For each connected SIP station, an "IP User" station license is required.

### SIP Authentication

In order to ensure the security of the internal network, it is important that SIP subscribers are authenticated at the communication system with the values described below. These values must be configured in the WBM of the communication system for each SIP subscriber and also at every SIP phone itself. To protect against SIP attacks, authentication is strongly recommended!

- Password  
Password for authentication: assigned freely; at least 8 characters up to a maximum of 20 characters. The password should contain at least one uppercase letter, one lowercase letter, one digit and one special character. A separate password should be assigned for each SIP subscriber.
- SIP User ID / Username  
User name for authentication: preassigned; can be changed if required, maximum 20 characters. Each SIP subscriber has a different preassigned SIP User ID.
- Realm  
Zone or domain for authentication: assigned freely; can be changed if required, max. 20 characters. The realm for all SIP subscribers is preassigned with the same value. It can be changed as required, e.g., in the host name or domain name of the communication system.

### Configuration of SIP Stations in the Communication System

The following configurations can be performed in the WBM of the communication system for an IP station:

- Configuration of standard parameters with the IP Telephones wizard (see [How to Configure SIP Stations](#)).
- Configuration of all parameters (standard and advanced parameters in Expert mode (see [Station > Station > IP Clients](#))).

### Configuration of the SIP phone

The data used to authenticate a SIP subscriber at the communication system must be additionally entered directly at the SIP phone.

Configuration of authentication data at the SIP phone (see [Configuring the Authentication Data at the SIP Phone](#)).

### Features that can be used with SIP Telephones

The following features can be used with SIP telephones:

- Incoming and outgoing calls with display of call number and name
- Hold, Toggle/Connect, Consultation
- Call transfer (screened/unscreened)
- Take Call
- Immediate call forwarding, on busy and after timeout
- Three-party conference
- Call lists, message waiting indicator
- Ringer cutoff at phone, reject call, call forwarding
- Call waiting
- Membership in groups (without display of the group number)
- Different calls for internal, external and recall
- Mailbox LED - Message Waiting Indication
- DTMF dialing, e.g., for the operation of voicemail boxes
- Use of the UC clients
- Automatic software updates (when using the DLI)

---

**INFO:** Deployment with a multichannel Contact Center has not been released.

---

Depending on the telephone, there may be some restrictions on the available functions; see the wiki at: [http://wiki.unify.com/wiki/SIP\\_devices\\_configuration\\_examples](http://wiki.unify.com/wiki/SIP_devices_configuration_examples)

The following features, which are activated using codes with \* or #, can be used with SIP phones:

- Reset services: #0
- Join/Leave hunt group: \*85/#85
- Station number suppression (CLIR) on/off: \*86/#86
- Speed dial: \* 7nnnn (nnnn = speed dial number)
- Door opener: \*61

### **Features that can be used with SIP Telephones and myPortal/myAttendant**

SIP phones to be used with myPortal and myAttendant must meet the following requirements:

- 3PCC as per RFC 3725 is supported.
- The "call waiting" feature is supported.
- The local Do Not Disturb is disabled.

The full functionality of the features depends on the SIP phone used and cannot be guaranteed. A successful test of the features listed below was performed with the OpenStage SIP telephones.

Connection-/call-oriented features:

- Making Call
- Redirect call
- Take Call
- Resume call
- Application-controlled conference
- Place call on hold
- Alternate (Toggle/Connect)
- Consultation
- Disconnect
- Transfer

Phone-oriented features:

- Do Not Disturb
- Call forwarding

## **10.5 UP0 stations**

A UP0 station uses a U<sub>P0/E</sub> line to transmit digital signals. UP0 stations are connected to the communication system via UP0 interfaces and are system telephones such as an OpenStage 60T, for example. UP0 stations can therefore use the complete functional scope of the communication system.

The following connectivity options are available for UP0 stations:

- OpenScape Business X1  
To the U<sub>P0/E</sub> interfaces on the mainboard.
- OpenScape Business X3/X5  
To the U<sub>P0/E</sub> interfaces on the mainboard or, if several UP0 stations are involved, to an additionally inserted U<sub>P0/E</sub> board.
- OpenScape Business X8  
To additionally inserted U<sub>P0/E</sub> boards.
- OpenScape Business S  
No connection possible.



For each connected UP0 station, a "TDM User" station license is required. Even system telephones that are connected in slave mode require a station license.

### **Configuring the UP0 Stations**

The following configurations can be performed for a UP0 station:

- Configuration of standard parameters with the UP0 Devices wizard (see [How to Configure UP0 Stations](#)).
- Configuration of all parameters (standard and advanced parameters in Expert mode (see [Station > Station > UP0 Stations](#))).

## **10.6 DECT stations**

A DECT station uses a Cordless base station to transmit digital signals. A DECT station is a DECT telephone.

The following connection options are available for DECT stations:

- OpenScape Business X1/X3W/X3R/X5R  
Cordless base station to a UP0/E interface of the mainboard.
- OpenScape Business X5W  
Cordless base station to a UP0/E interface of the mainboard or to an SLC16N board.
- OpenScape Business X8  
Cordless base station to one or more SLCN boards.
- OpenScape Business S  
DECT IP base station on the LAN

The connection of a Cordless base station is called the integrated Cordless solution. This means that almost all functions of the communication system are available.

The integration of an IP DECT base station in the internal network is called Cordless IP. Since only the SIP protocol can be used in this case, not all communication system features are available.

For each connected DECT station, a "TDM User" station license is required.

For the description and configuration of the integrated Cordless solution, see [Integrated Cordless Solution](#).

### **Configuring DECT Stations**

The following configurations can be performed for a DECT station:

- Configuration of standard parameters with the DECT Devices wizard (see [How to Configure DECT Stations](#)).
- Configuration of all parameters (standard and advanced parameters in Expert mode (see [Station > Station > DECT Stations > DECT Stations](#))).

DECT IP stations are configured as normal SIP stations.

## 10.7 ISDN Stations

An ISDN station uses the  $S_0$  bus for transmitting digital signals and is therefore often referred to an  $S_0$  station. The ISDN station is connected to the communication system via the  $S_0$  interfaces.

The following connection options are available for an  $S_0$  station:

- OpenScape Business X1  
To an  $S_0$  interface of the mainboard.
- OpenScape Business X3/X5  
To an  $S_0$  interface of the mainboard or to an  $S_0$  board.
- OpenScape Business X8  
To one or more  $S_0$  boards.
- OpenScape Business S  
To additionally required gateways or adapters.

The following ISDN stations can be connected:

- ISDN phone
- Fax Group 4
- ISDN modem
- PC with ISDN card

The following types of ISDN stations can be defined:

- Default: for ISDN phone, Fax Group 4, ISDN modem or PC with ISDN card
- Fax: prerequisites for setting up the "Info from Fax/Answering Machine" key. If a PC with an ISDN card and Fax software is attached to the  $S_0$  bus and assigned the type "Fax", for example, then an "Info from Fax/Answering Machine" key could be set up on every device. When this key lights up, this indicates that a fax has been received.
- Answering machine: prerequisites for picking up a call when the answering machine has already accepted it. If a Gigaset ISDN phone with an answering machine is connected and assigned the type "Answering Machine", for example, a call that has already been accepted by the answering machine can be picked up at any terminal. To do this, the terminal must be programmed with the internal call number of the Gigaset.

For each connected ISDN station, a "TDM User" station license is required.

### Connecting ISDN Stations to the $S_0$ Port

To be able to connect an ISDN station to the communication system, you must configure at least one of the  $S_0$  ports that are used for the ISDN subscriber line or the ISDN point-to-point connection as an internal  $S_0$  bus ( $S_0$  EURO bus).

---

**INFO:** If there is more than one ISDN station connected to an  $S_0$  port (up to 8 ISDN stations are possible) in an ISDN point-to-multi-point connection, each individual ISDN station must be assigned

to a unique MSN. This assignment must be made in the configuration menu of the ISDN station.

---

### Configuring ISDN stations

The following configurations can be performed for an ISDN station:

- Configuration of standard parameters with the ISDN Devices wizard (see [How to Configure ISDN Stations](#)).
- Configuration of all parameters (standard and advanced parameters via Expert mode (see [Station > Station > ISDN Stations](#))).

### Allowing only Configured Numbers for MSNs

The administrator can specify that further MSNs at an S<sub>0</sub> bus may only be configured for call numbers that already exist there. This prevents subscribers from adding an MSN without authorization through an outgoing seizure of the S<sub>0</sub> bus with a further MSN. Without this restriction, the communication system would normally assign a free internal call number to the S<sub>0</sub> bus for that MSN.

### Terminal Portability

The communication system supports Terminal Portability (TP), that is, it lets you park a call on the S<sub>0</sub> bus, unplug the terminal, and plug it back in at a new location to resume the call. The parked station receives a message indicating that the user is porting. Three minutes are available for the entire operation.

The feature is not supported for services such as telefax, teletex or data transfer.

## 10.7.1 How to Configure the S<sub>0</sub> Interface for ISDN Stations

You can use the **CO Trunk ISDN / Analog / ITSP** wizard to configure one or more S<sub>0</sub> ports so that ISDN phones can be connected to them.

### Prerequisites

- One or more free S<sub>0</sub> interfaces are available.
- You are logged on to the WBM with the **Advanced** profile.

### Step by Step

- 1) In the navigation bar, click on **Setup**.
- 2) In the navigation tree, click **Wizards > Central Telephony**.
- 3) Click **Edit** in the **CO Trunk ISDN / Analog / ITSP** wizard.
- 4) Click on **OK & Next**. The existing S<sub>0</sub> interfaces (S<sub>0</sub> ports) are displayed.

Box	Slot	S0-Port	Board Type	Point-to-point connection	Point-to-multipoint connection	Internal S0 connection	Settings configured in expert mode
1	1	1	STLS2N	<input checked="" type="radio"/>	<input type="radio"/>	<input type="radio"/>	
1	1	2	STLS2N	<input type="radio"/>	<input type="radio"/>	<input checked="" type="radio"/>	

5) Do not alter the setting for the check box **No call via ISDN trunk line (S0)**.

6) Activate the **Internal S0 connection** radio button for the desired **S0** ports.

---

**INFO:** These S<sub>0</sub> ports can no longer be used for ISDN trunk access.

---

7) Keep clicking **OK & Next** until you receive a message that the editing of the feature has been completed.

8) Click on **Finish**.

## 10.7.2 How to Allow only Configured Numbers for MSNs

### Prerequisites

- You are logged into the WBM with the **Expert** profile.

### Step by Step

- In the navigation bar, click on **Expert Mode**.
- Click **Telephony > Basic Settings** in the navigation tree.
- In the menu tree, click **Basic Settings > System > System Flags**.

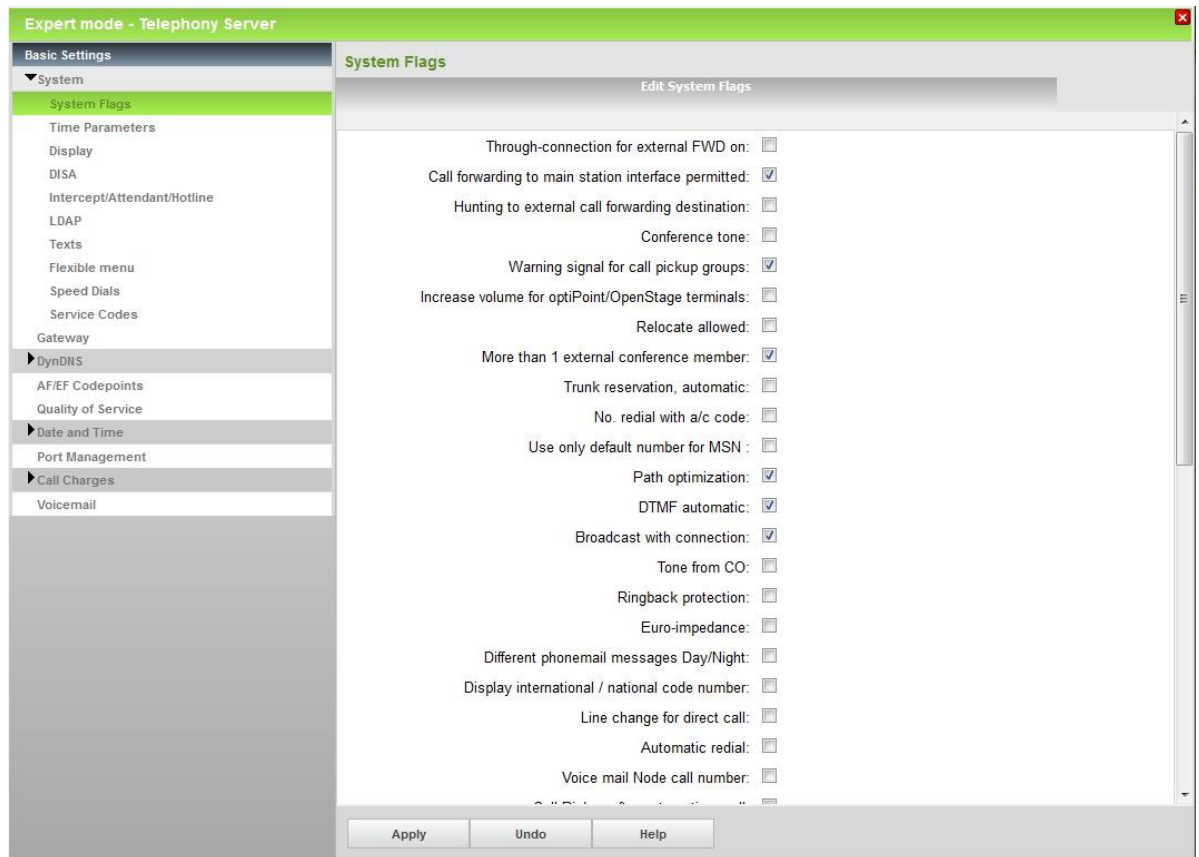

- 4) If you want to allow only configured numbers for MSNs, enable the check box **Use only default number for MSN**.
- 5) If you do not want to allow only configured numbers for MSNs, clear the check box **Use only default number for MSN**.
- 6) Click on **Apply** followed by **OK**.

## 10.8 Analog Stations

An analog station uses a two-core analog cable to transmit analog signals. The communication system connects the analog station via the analog ports.

The following connectivity options are available for analog stations:

- OpenScope Business X1  
To an analog interface of the mainboard.
- OpenScope Business X3/X5  
To an analog interface of the mainboard or to an analog board.
- OpenScope Business X8  
To one or more analog boards.
- OpenScope Business S  
To additionally required gateways or adapters

The following analog stations can be connected:

- Analog telephone
- Analog Fax (Group 3)
- Answering Machine
- Modem, 9600 bps or higher
- Entrance Telephone (Door Opener)
- Loudspeaker

The following types of analog stations can be defined:

- Standard: for analog phone, Group 3 fax, answering machine or loudspeakers
- Fax: prerequisites for setting up the "Info from Fax/Answering Machine" key. If a Fax Group 3 device is connected and assigned the type "Fax", for example, then an "Info from Fax/Answering Machine" key could be set up on every device. When this key lights up, this indicates that a fax has been received.
- Answering machine: prerequisites for picking up a call when the answering machine has already accepted it. If a Gigaset phone with an answering machine is connected and assigned the type "Answering Machine", for example, a call that has already been accepted by the answering machine can be picked up at any terminal. To do this, the terminal must be programmed with the internal call number of the Gigaset.
- Modem: Analog modems with a fixed speed of 56 kbps or higher are not supported, since speeds of 56 kbps or higher cannot be processed.

For each connected analog station, a "TDM User" station license is required.

### **Availability of an Analog Fax Device in the System with Previous Fax Number**

Since it is not possible to forward an analog fax device to a fax number in the system, the following workaround exists: The previous fax number is configured in the system and receives the incoming fax messages. For the analog fax device, a port is configured with the previous number as the CLIP. The Configurable CLIP check box must be selected for this purpose. Outbound fax messages show the previous number as the sender; internal recipients see the internal number of the fax machine.

### **Configuring Analog Stations**

The following configurations can be performed for an analog station:

- Configuration of standard parameters with the Analog Devices wizard (see [How to Configure Analog Stations](#)).
- Configuration of all parameters (standard and advanced parameters via Expert mode (see [Station > Station > Analog Stations](#))).

## **10.9 Virtual Stations**

Virtual stations behave like real stations, but have no physical telephones assigned to them.

Virtual stations are required for mobile phone integration and call forwarding no answer (CFNA), for example. These stations must be configured like real stations so that they can be used for the signaling of calls, for example.

### Configuring Virtual Stations

The parameters associated with a virtual station are configured in Expert mode (see [Station > Station > Virtual Stations](#)).

## 10.10 Key programming

Every system phone comes with a certain number of function keys. A number of these function keys are programmed by default with functions. You can modify this default setting and program the remaining function keys that were not preprogrammed.

The individual keys can be programmed as follows:

- Key programming via WBM  
The keys on connected system telephones can be programmed in the WBM via the **Key Programming** wizard.  
This wizard can also be used to program a key assignment for a subscriber even though no system telephone has been connected for that subscriber.
- Key programming via the UC clients  
Users of the UC clients **myPortal Smart**, **myPortal for Desktop**, **myPortal for Outlook** and **myAttendant** can also program the keys on their system telephone via these UC clients (see the respective User Guides for the UC clients).
- Key programming directly at the system telephone  
System phones with display allow you to program certain function keys directly at the phone.

### Programming Function Keys on Different Levels

The function keys of the system telephones can be programmed twice, that is, on the first and second levels. You can program all available functions on the first level. You can program external phone numbers on the second level. The Shift key must be programmed on the system phone before you can use the second level. The function key LEDs are always assigned to the first level.

---

**INFO:** In case of a \*\*user it is not possible to copy key programming as the automatic key assignment feature is MULAP specific and should not be copied at any station. The prefix \*\* should be removed manually from these users in order the key copy to be enabled.

---

## 10.10.1 How to Program the Function Keys on the System Phones

You can use the **Key Programming** wizard to configure the function keys on the system phones.

### Prerequisites

- You are logged on to the WBM with the **Advanced** profile.

### Step by Step

- 1) In the navigation bar, click on **Setup**.
- 2) In the navigation tree, click **Wizards > Telephones / Stations**.
- 3) Click **Edit** to start the **Key Programming** wizard. A list of all stations is displayed.
- 4) Click **Edit** in the row containing the station you want.
- 5) Assign the system phone to the station:
  - If a system telephone is already connected for the station, you will be presented with a simplified display of the system telephone.
  - If no system telephone is connected for the station as yet, select the system telephone to be connected from the drop-down list. You will then be presented with a simplified display of the system telephone.
- 6) Click in the simplified display of the system telephone on the desired key field. The function keys of the selected key field will be displayed with the currently assigned functions.

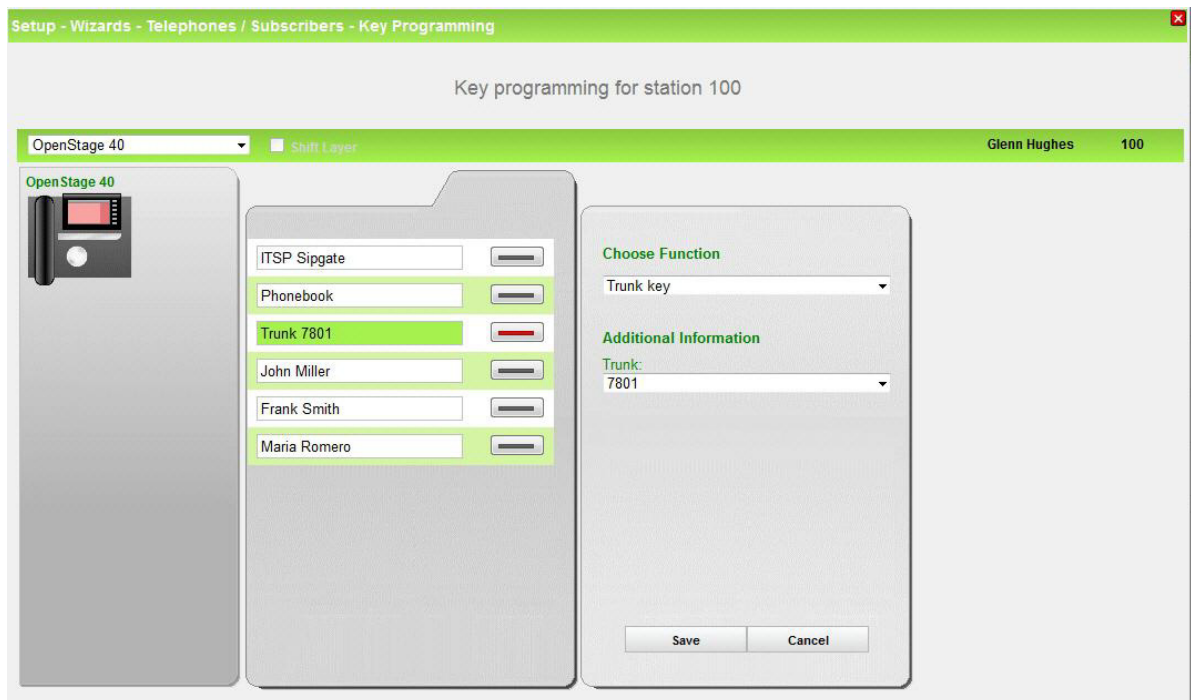



- 7) Assign functions to the function keys:
  - a) Click on the key symbol for the function key to be assigned. A drop-down list with the available functions appears.
  - b) Select one of the offered choices **Select Function** drop-down list.
  - c) Some functions require additional information. Select this as needed or enter the required data.
  - d) Click **Save**.
  - e) If required, edit the function key label in the **Change predefined label** field.

---

**INFO:** If you have a system telephone with automatic key labeling (such as an OpenStage 60 HFA, for example), this text will appear in the display of the system telephone.

---

- f) Click **Save**.
  - g) If you want to assign functions to further function keys, repeat step 7.
- 8) If you programmed a function key as the **Shift Key**, select the **Shift Key** check box. Program the second level of the function keys with the external call numbers as described below under step 7.
- 9) Click **Save Keypad**.
- 10) If you want to apply the key assignment just completed to several or all system telephones, enable the check box for the desired system phones and then click on **Apply**, **OK** and **OK & Next**.
- 11) If you want to apply the key assignment just completed to only the selected system telephone, first click on **Deselect all stations** to be on the safe side and then on **OK & Next**.
- 12) Click **Next** followed by **Finish**.

## 10.11 Station Profiles

The values and properties of subscribers are stored in profiles. One or more members can be assigned to a profile. The same values and properties then apply to all members of that profile.

Station profiles can be assigned to subscribers with system telephones. Up to 20 station profiles can be created. The station profiles can be exported or imported individually or collectively. The files are of type `xml`.

Every subscriber can be a member of exactly one profile. If the values and properties of a station that is a member of a profile are changed directly, i.e., not through the profile, the station is deleted from the profile.

## 10.12 Configuring Stations

You can define specific values (for example, phone number, name, and DID number) and properties (for example, type of call signaling) for the station.

Station configuration is split into standard configuration and advanced configuration. The default settings can be configured using wizards with the **Advanced** profile. The Advanced settings can only be configured in Expert mode with the **Expert** profile.

The default settings can be conveniently edited in a list for all stations of a station type (e.g., IP stations or analog stations). Additional settings (such as call signaling or the station flags, for example) can be changed individually for each subscriber.

Virtual stations are configured entirely in Expert mode (both the standard and the advanced settings).

Although the **Basic** profile cannot be used to configure stations, it can be used to edit the names of stations.

A dial plan (also called a numbering plan) should be available for the stations connected to the communication system. The station numbers, names and DID numbers of all configured subscribers can be displayed in Expert mode via **Stations > DDI Extensions**.

DID numbers which are not provided by the service provider and which are not used in the system should be deleted; otherwise, there may be conflicts with MSN or Internet telephony phone numbers. DID numbers that are provided by an Internet Telephony Service Provider (ITSP) must be assigned to the individual stations when configuring the ITSP (see [Configuring an ITSP](#)).

---

**IMPORTANT:** Whenever the phone number of a station is changed, the Smart VM (Voicemail) configured for that station is automatically reset. All personal voice messages, greetings and announcements are lost, and the password is reset.

---

### Default Settings

The default settings should be verified for every station and adapted if required.

- **Station Number, Name, DID Number**

Every station is assigned a station number by default (such as 101). The station can be reached internally under this call number. In system phones, this phone number appears both on the actual display and the communication partner's display. If a station number other than the actual station number is to be displayed at the external station called, this number can be defined here. You can also assign a DID number to each station. The station can be accessed directly from an external location with the DID number. The station can be reached internally via the call number 101, for example, and externally via the DID number 3654321 (MSN in a point-to-multipoint connection) or <PABX number>-101 (in a point-to-point connection). In the case of a point-to-point connection, you can configure whether the internal phone number

should be automatically entered as a DID number during initial installation. The DID number may also differ from the phone number. If you are using Internet telephony, you can also define a DID number that can be used to reach the station via Internet telephony. This phone number is made available by the Internet Telephony Service Provider.

You can also assign a name to each station. This name appears on the communication partner's display (system phones only).

If a dial plan exists, the phone numbers, DID numbers, and names of the subscribers should be adjusted based on the dial plan.

- **Type**

The station type can be selected for every station. For example, an IP station could have a station type of **System Client** or **SIP Client**; an analog station may be an analog phone or an analog fax machine, and an ISDN station could be an ISDN phone or ISDN fax.

- **Fax call number; Fax DID number**

If the a fax box is to be set up for a subscriber (which can be used with the UC clients myPortal for Desktop or myPortal for Outlook, for example), assign a fax call number (for receiving internal faxes) and a fax DID number (for receiving external faxes).

- **Classes of Service**

A station can be assigned one out of 15 possible classes of service. This determines whether a station may accept and make external calls, for example, or which numbers may be dialed by the station and which are not allowed (see [Classes of Service \(Toll Restriction\)](#)).

- **Call pickup group**

Every station can be assigned to a call pickup group.

- **Language, call signaling**

The language used for the menu controls of the attached system telephones can be set.

The ring tone for an internal or external call can be selected.

- **Voicemail box (only with UC Smart)**

With the UC solution UC Smart, you can set up a voicemail box for each subscriber and choose between different greetings. For more detailed information on the voicemail box, see [Voicemail Box \(SmartVM\)](#)

With the UC solution UC Suite, a voicemail box is assigned automatically to each subscriber. Consequently, there are no voicemail box settings in this case.

- **Station flags**

The station flags of each subscriber can be changed. For a description of the station flags, see [Station > Station > Station Parameters](#).

### **Advanced Settings**

You can configure all settings for all types of stations in Expert mode. The advanced settings can be left unaltered for default operation and only have to be changed if required. For information on the advanced settings, see [Station](#).

**Related Topics**

- [Classes of Service \(Toll Restriction\)](#)

## 10.12.1 How to Configure IP Stations

You can use the **IP Telephones** wizard to configure the IP stations (LAN phones and WLAN phones).

**Prerequisites**

- A functional wireless LAN network is needed to operate WLAN phones.
- You are logged on to the WBM with the **Advanced** profile.

**Step by Step**

- 1) In the navigation bar, click on **Setup**.
- 2) In the navigation tree, click **Wizards > Telephones / Subscribers**.
- 3) Click on **Edit** to start the **IP Telephones** wizard. A list of all IP stations appears.

Select a station -LAN Phones

Take DID from changed call number

Box Slot	Callno	Name	DID	Type	Fax Callno	Fax DID	Class of service	Call pickup
1 0	110	Natalie Dubois	110	System Client	-	-	International	-
1 0	111	Pierre Martin	111	System Client	-	-	International	-
1 0	112	Claudia Ferraro	112	System Client	-	-	International	-
1 0	113	Giovanni Rossi	113	System Client	-	-	International	-
1 0	114	Carlos Alvarez	114	System Client	-	-	International	-
1 0	115	Emilia Gonzales	115	System Client	-	-	International	-
1 0	120	Isabel Ferreira	120	SIP Client	-	-	International	-
1 0	121	Paolo DaSilva	121	SIP Client	-	-	International	-
1 0	122	Ivan VanDenBerg	122	SIP Client	-	-	International	-
1 0	123	Robert DeJong	123	SIP Client	-	-	International	-

- 4) If you want the internal call number to be automatically assigned to the station as the direct inward dialing number, activate the radio button **Take DID from changed call number**.
- 5) If you want a different direct inward dialing number for the station than the call number, enter a DID number for the station under **DID** in the row of the desired station:
  - Only for a point-to-point connection:  
Click in the desired field and type in the DID number using the keyboard. The DID number may also be identical to the internal station number.
  - Only for a point-to-multipoint connection:  
Select an MSN in the desired field via the drop-down list. The station can be internally reached via the internal station number 101, for example, and externally via the MSN 654321.

- For point-to-point and point-to-multipoint connections:  
Select the entry **xxx - modifiable** (xxx is the internal station number) via the drop-down list in the desired field and type in the DID number using the keyboard or select an MSN from the drop-down list.
- 6) If you want an Internet telephony phone number to be assigned to the station as the direct inward dialing number, leave the radio button **Take DID from changed call number** unselected, and select the Internet Telephony Service Provider from the list next to the radio button instead. Then select the Internet Telephony phone number from the **DID** drop-down list in the row of the desired station.
- 7) Enter the internal station number for the subscriber under **Call No** in the appropriate row of the desired subscriber. You can use the preset phone number or assign some other free number.
- 8) In the row of the desired station, under **Name**, enter a name in the format `Last Name, First Name Or First Name Last Name`.
- 9) Select the type of IP station (e.g., **System Client** or **DeskShare User**) from the **Type** drop-down list in the row of the desired station).
- 10) If you want to set up a fax box for the subscriber (which can be used with the UC clients **myPortal for Desktop** or **myPortal for Outlook**, for example), proceed as follows:
  - a) In the row of the desired station, in the **Fax No.** field, enter the desired internal fax number at which the user can receive internal fax messages.
  - b) If you want to configure a DID number for the fax box, enter the desired external fax number under which the subscriber can receive external fax messages in the **Fax DID** field in the row of the desired subscriber.
- 11) Choose the desired Class of Service group in the row of the desired subscriber from the **Class of Service** drop-down list.
- 12) To add the subscriber to a call pickup group, select a call pickup group from the **Call pickup group** drop-down list in the row of the desired subscriber.
- 13) Make any further settings if required:
  - a) Click in the row of the desired station on the pencil icon **Edit**.

**Stations**  
Configuring Stations

Change Station	
Station	Fax
Name: (for Subscriber):	Natalie Dubois
Call number:	110
Direct inward dialing: (Number for Direct Inward Dialing)	110
<b>direct inward dialing for Internet Telephony</b>	
Sipgate	4989565656114
<b>Parameter</b>	
Type	System Client
Device Type:	OpenStage 40
Clip/Lin:	-
Language:	German
Call signaling internal: (Ringer pitch for internal calls):	Ring type 1
Call signaling external: (Ringer pitch for external calls):	Ring type 1

- b) Assign one **Mobile Call number** and select the **Web Feature ID** from the drop-down list in the **Mobility** area.
- c) In the **Clip/Lin** field, enter a phone number (DID number or MSN) to be displayed at the called party's extension instead of the own phone number in the case of an external call.

---

**INFO:** This feature must be released by the network provider.

---

- d) Select the language for the menu controls on the phone from the **Language** drop-down list.
- e) From the **Call signaling internal** drop-down list, select and assign one of a total of eight possible acoustic call signals for internal calls. The station then will then send the modified ringing tone to other internal stations, thus enabling its calls to be distinguished from other internal stations (default: Ring type 1).
- f) From the **Call signaling external** drop-down list, select and assign one of a total of three possible acoustic call signals for external calls (default: Ring type 1).
- g) In the **ITSP Loc-ID** field, enter the index number of the ITSP Location ID.
- h) Only with UC Smart: Select whether the subscriber is to receive a default mailbox or an attendant mailbox (AutoAttendant) in the **UC Smart Mailbox type** drop-down list.
- i) Only with UC Smart and default mailbox: If a caller may leave a message in the voicemail box, select the **Recording** check box.
- j) Only with UC Smart: Select a greeting from the **Greeting** drop-down list.
- k) Only with UC Smart: If the password of the voicemail box is to be reset, select the **Password Reset** check box.

---

**INFO:** The **Password Reset** check box must be cleared when setting up a new voicemail box. It is used to reset the password of the voicemail box. When a new voicemail box is created, the subscriber must change the initial password anyway when accessing his or her voicemail box for the first time.

---

- l)* If the station is connected to the internet, Authentication **MUST** be activated and you **MUST** enter strong passwords for all IP stations. Check the **Authentication active** flag list and complete the **New password** and **Confirm password** fields.
  - m)* Click on **OK & Next**.
  - n)* Change the station flags as needed. For a description of the station flags, see [Station > Station > Station Parameters](#).
  - o)* Click on **OK & Next**.
- 14)** If you want to configure another station, repeat steps [5](#) through [13](#).
- 15)** Click on **OK & Next**. A list of all configured IP stations appears. If required, you can print the list of IP stations with **Print**.
- 16)** Click on **OK & Next** followed by **Finish**.

## 10.12.2 How to Configure SIP Stations

You can use the **IP Telephones** wizard to configure the SIP stations (LAN phones and WLAN phones).

### *Prerequisites*

- A functional wireless LAN network is needed to operate WLAN phones.
- You are logged on to the WBM with the **Advanced** profile.

### *Step by Step*

- 1)** In the navigation bar, click on **Setup**.
- 2)** In the navigation tree, click **Wizards > Telephones / Subscribers**.
- 3)** Click on **Edit** to start the **IP Telephones** wizard. A list of all IP stations appears. This list also includes all SIP stations.

**Stations**  
Configuring Stations

Select a station -LAN Phones

Take DID from changed call number

Box Slot	Callno	Name	DID	Type	Fax Callno	Fax DID	Class of service	Call pickup
1 0	110	Natalie Dubois	110	System Client	-	-	International	-
1 0	111	Pierre Martin	111	System Client	-	-	International	-
1 0	112	Claudia Ferraro	112	System Client	-	-	International	-
1 0	113	Giovanni Rossi	113	System Client	-	-	International	-
1 0	114	Carlos Alvarez	114	System Client	-	-	International	-
1 0	115	Emilia Gonzales	115	System Client	-	-	International	-
1 0	120	Isabel Ferreira	120	SIP Client	-	-	International	-
1 0	121	Paolo DaSilva	121	SIP Client	-	-	International	-
1 0	122	Ivan VanDenBerg	122	SIP Client	-	-	International	-
1 0	123	Robert DeJong	123	SIP Client	-	-	International	-

- 4) If you want the internal call number to be automatically assigned to the station as the direct inward dialing number, activate the radio button **Take DID from changed call number**.
- 5) If you want a different direct inward dialing number for the station than the call number, enter a DID number for the station under **DID** in the row of the desired station:
  - Only for a point-to-point connection:  
Click in the desired field and type in the DID number using the keyboard. The DID number may also be identical to the internal station number.
  - Only for a point-to-multipoint connection:  
Select an MSN in the desired field via the drop-down list. The station can be internally reached via the internal station number 101, for example, and externally via the MSN 654321.
  - For point-to-point and point-to-multipoint connections:  
Select the entry **xxx - modifiable** (xxx is the internal station number) via the drop-down list in the desired field and type in the DID number using the keyboard or select an MSN from the drop-down list.
- 6) If you want an Internet telephony phone number to be assigned to the station as the direct inward dialing number, leave the radio button **Take DID from changed call number** unselected, and select the Internet Telephony Service Provider from the list next to the radio button instead. Then select the Internet Telephony phone number from the **DID** drop-down list in the row of the desired station.
- 7) Enter the internal station number for the subscriber under **Call No** in the appropriate row of the desired subscriber. You can use the preset phone number or assign some other free number.
- 8) In the row of the desired station, under **Name**, enter a name in the format Last Name, First Name OR First Name Last Name.
- 9) Select **SIP Client** from the **Type** drop-down list in the row of the desired station.



- 10) If you want to set up a fax box for the subscriber (which can be used with the UC clients **myPortal for Desktop** or **myPortal for Outlook**, for example), proceed as follows:
  - a) In the row of the desired station, in the **Fax No.** field, enter the desired internal fax number at which the user can receive internal fax messages.
  - b) If you want to configure a DID number for the fax box, enter the desired external fax number under which the subscriber can receive external fax messages in the **Fax DID** field in the row of the desired subscriber.
- 11) Choose the desired Class of Service group in the row of the desired subscriber from the **Class of Service** drop-down list.
- 12) To add the subscriber to a call pickup group, select a call pickup group from the **Call pickup group** drop-down list in the row of the desired subscriber.
- 13) Configure the data for SIP:
  - a) Click in the row of the desired station on the pencil icon **Edit**.

Change Station

	Station	Fax
Name: (for Subscriber):	<input type="text" value="Paolo DaSilva"/>	
Call number:	<input type="text" value="121"/>	<input type="text"/>
Direct inward dialing: (Number for Direct Inward Dialing)	<input type="text" value="121"/>	<input type="text"/>
<b>Mobility</b>		
Mobile Call number:	<input type="text" value="0016012345678"/>	
Web Feature ID:	<input type="text" value="(SIP Client) 121"/>	
<b>direct inward dialing for Internet Telephony</b>		
Sipgate	<input type="text" value="4989565656111"/>	<input type="text"/>
<b>Parameter</b>		
Type	<input type="text" value="SIP Client"/>	
Device Type:	SIP Extension	
Clip/Lin:	<input type="text"/>	
Language:	<input type="text" value="German"/>	
Call signaling internal: (Ringer pitch for internal calls):	<input type="text" value="Ring type 1"/>	
Call signaling external: (Ringer pitch for external calls):	<input type="text" value="Ring type 1"/>	
<b>Security</b>		
Authentication active:	<input checked="" type="checkbox"/>	
Password:	<input type="password" value="*****"/>	
Confirm password:	<input type="password" value="*****"/>	
SIP User ID / Username:	<input type="text" value="SIP-121"/>	
Realm:	<input type="text" value="SOBIZ-SIP"/>	

- b) In the **Security** area, enable the check box **Authentication active**.
- c) Enter the password for the authentication of the SIP station in the **Password** and **Confirm password** fields.
- d) Assign a user name of your choice for the authentication of SIP station, e.g., SIP-120, in the **SIP User ID / Username** field.
- e) Under **Realm**, assign a name of your choice for the associated zone, e.g., OSBIZ-SIP. This value should be the same for all SIP stations.

---

**INFO:** The values defined here for the password, SIP user ID and realm must also be entered at the SIP phone.

---

**14) Make any further settings if required:**

- a)** If this SIP phone is to be operated in conjunction with a dual-mode mobile phone, enter the dialout prefix followed by the telephone number of the mobile phone (e.g., 0016012345678) in the Mobility area under Mobile phone number. In addition, select this SIP client from the Web Feature ID drop-down list. (see [Dual-Mode Telephony](#)).
- b)** Assign one DID number each for Internet telephony to the station and, if desired, to its fax box in the **Direct inward dialing for Internet Telephony** area. To do this, select the DID numbers from the drop-down lists of the desired ITSPs. For every active ITSP, you will be presented with one drop-down list for the station and one drop-down list for its fax box.

---

**INFO:** The **DID for Internet Telephony** field is not visible if Internet telephony is not configured or if no Internet Telephony Service Provider has been activated.

---

- c)** In the **Clip/Lin** field, enter a phone number (DID number or MSN) to be displayed at the called party's extension instead of the own phone number in the case of an external call.

---

**INFO:** This feature must be released by the network provider.

---

- d)** Select the language for the menu controls on the phone from the **Language** drop-down list.
- e)** From the **Call signaling internal** drop-down list, select and assign one of a total of eight possible acoustic call signals for internal calls. The station then will then send the modified ringing tone to other internal stations, thus enabling its calls to be distinguished from other internal stations (default: Ring type 1).
- f)** From the **Call signaling external** drop-down list, select and assign one of a total of three possible acoustic call signals for external calls (default: Ring type 1).
- g)** Only with UC Smart: Select whether the subscriber is to receive a default mailbox or an attendant mailbox (AutoAttendant) in the **UC Smart Mailbox type** drop-down list.
- h)** Only with UC Smart and default mailbox: If a caller may leave a message in the voicemail box, select the **Recording** check box.
- i)** Only with UC Smart: Select a greeting from the **Greeting** drop-down list.
- j)** Only with UC Smart: If the password of the voicemail box is to be reset, select the **Password Reset** check box.

---

**INFO:** The **Password Reset** check box must be cleared when setting up a new voicemail box. It is used to reset the password of the voicemail box. When a new voicemail box is created, the subscriber must change the initial password anyway when accessing his or her voicemail box for the first time.

---

- k) Click on **OK & Next**.
  - l) Change the station flags as needed. For a description of the station flags, see [Station > Station > Station Parameters](#).
  - m) Click on **OK & Next**.
- 15) If you want to configure another station, repeat steps 5 through 14.
- 16) Click on **OK & Next**. A list of all configured IP stations appears. If required, you can print the list of IP stations with **Print**.
- 17) Click on **OK & Next** followed by **Finish**.

### 10.12.3 How to Configure UP0 Stations

You can use the **UP0 Devices** wizard to configure the UP0 stations.

#### Prerequisites

- You are logged on to the WBM with the **Advanced** profile.

#### Step by Step

- 1) In the navigation bar, click on **Setup**.
- 2) In the navigation tree, click **Wizards > Telephones / Subscribers**.
- 3) Click on **Edit** to start the **UP0 Devices** wizard. A list of all UP0 stations appears.

Select a station -UP0 Phones

Take DID from changed call number

Box	Slot	UP0-Port	Callno	Name	DID	Fax Callno	Fax DID	Class of service	Call pickup
	1	2	1 M	100	Andreas Richter	100	-	International	-
	1	2	2 M	101	Susanne Mueller	101	-	International	-
	1	2	3 M	102	Buddy Miller	102	-	International	-
	1	2	4 M	103	Janet Jones	103	-	International	-
	1	2	5 M	-	-	-	-	International	-
	1	2	6 M	-	-	-	-	International	-
	1	2	7 M	-	-	-	-	International	-
	1	2	8 M	-	-	-	-	International	-
	1	2	1 S	-	-	-	-	International	-
	1	2	2 S	-	-	-	-	International	-

- 4) If you want the internal call number to be automatically assigned to the station as the direct inward dialing number, activate the radio button **Take DID from changed call number**.

- 5) If you want a different direct inward dialing number for the station than the call number, enter a DID number for the station under **DID** in the row of the desired station:
  - Only for a point-to-point connection:  
Click in the desired field and type in the DID number using the keyboard. The DID number may also be identical to the internal station number.
  - Only for a point-to-multipoint connection:  
Select an MSN in the desired field via the drop-down list. The station can be internally reached via the internal station number 101, for example, and externally via the MSN 654321.
  - For point-to-point and point-to-multipoint connections:  
Select the entry **xxx - modifiable** (xxx is the internal station number) via the drop-down list in the desired field and type in the DID number using the keyboard or select an MSN from the drop-down list.
- 6) If you want an Internet telephony phone number to be assigned to the station as the direct inward dialing number, leave the radio button **Take DID from changed call number** unselected, and select the Internet Telephony Service Provider from the list next to the radio button instead. Then select the Internet Telephony phone number from the **DID** drop-down list in the row of the desired station.
- 7) Enter the internal station number for the subscriber under **Call No** in the appropriate row of the desired subscriber. You can use the preset phone number or assign some other free number.
- 8) In the row of the desired station, under **Name**, enter a name in the format `Last Name, First Name Or First Name Last Name`.
- 9) If you want to set up a fax box for the subscriber (which can be used with the UC clients **myPortal for Desktop** or **myPortal for Outlook**, for example), proceed as follows:
  - a) In the row of the desired station, in the **Fax No.** field, enter the desired internal fax number at which the user can receive internal fax messages.
  - b) If you want to configure a DID number for the fax box, enter the desired external fax number under which the subscriber can receive external fax messages in the **Fax DID** field in the row of the desired subscriber.
- 10) Choose the desired Class of Service group in the row of the desired subscriber from the **Class of Service** drop-down list.
- 11) To add the subscriber to a call pickup group, select a call pickup group from the **Call pickup group** drop-down list in the row of the desired subscriber.
- 12) Make any further settings if required:
  - a) Click in the row of the desired station on the pencil icon **Edit**.

Change Station	
<b>Station</b>	Name: <input type="text" value="Andreas Richter"/> (for Subscriber): Call number: <input type="text" value="100"/> Direct inward dialing: (Number for Direct Inward Dialing) <input type="text" value="100"/>
<b>direct inward dialing for Internet Telephony</b>	Sipgate: <input type="text" value="4989565656100"/> Application Suite: <input type="text"/>
<b>Parameter</b>	Device Type: OpenStage 40 Clip/Lin: <input type="text" value="-"/> Language: <input type="text" value="German"/> Call signaling internal: (Ringer pitch for internal calls): <input type="text" value="Ring type 1"/> Call signaling external: (Ringer pitch for external calls): <input type="text" value="Ring type 1"/>

- b)** Select a DID number from the drop-down list in the **Direct inward dialing for Internet Telephony** area. A drop-down list is displayed for every active ITSP.

---

**INFO:** The **DID for Internet Telephony** field is not visible if Internet telephony is not configured or if no Internet Telephony Service Provider has been activated.

---

- c)** In the **Clip/Lin** field, enter a phone number (DID number or MSN) to be displayed at the called party's extension instead of the own phone number in the case of an external call.

---

**INFO:** This feature must be released by the network provider.

---

- d)** Select the language for the menu controls on the phone from the **Language** drop-down list.
- e)** From the **Call signaling internal** drop-down list, select and assign one of a total of eight possible acoustic call signals for internal calls. The station then will then send the modified ringing tone to other internal stations, thus enabling its calls to be distinguished from other internal stations (default: Ring type 1).
- f)** From the **Call signaling external** drop-down list, select and assign one of a total of three possible acoustic call signals for external calls (default: Ring type 1).
- g)** Only with UC Smart: Select whether the subscriber is to receive a default mailbox or an attendant mailbox (AutoAttendant) in the **UC Smart Mailbox type** drop-down list.
- h)** Only with UC Smart and default mailbox: If a caller may leave a message in the voicemail box, select the **Recording** check box.
- i)** Only with UC Smart: Select a greeting from the **Greeting** drop-down list.

- j) Only with UC Smart: If the password of the voicemail box is to be reset, select the **Password Reset** check box.

---

**INFO:** The **Password Reset** check box must be cleared when setting up a new voicemail box. It is used to reset the password of the voicemail box. When a new voicemail box is created, the subscriber must change the initial password anyway when accessing his or her voicemail box for the first time.

---

- k) Click on **OK & Next**.
  - l) Change the station flags as needed. For a description of the station flags, see [Station > Station > Station Parameters](#).
  - m) Click on **OK & Next**.
- 13) If you want to configure another station, repeat steps 5 through 12.
- 14) Click on **OK & Next**. A list of all configured UP0 stations appears. If required, you can print the list of UP0 stations with **Print**.
- 15) Click on **OK & Next** followed by **Finish**.

## 10.12.4 How to Configure DECT Stations

You can use the **DECT Devices** wizard to configure the DECT stations (DECT phones).

### Prerequisites

- A base station is connected to a UP0 interface or to an installed SLC board.
- You are logged on to the WBM with the **Advanced** profile.

### Step by Step

- 1) In the navigation bar, click on **Setup**.
- 2) In the navigation tree, click **Wizards > Telephones / Subscribers**.
- 3) Click on **Edit** to start the **DECT Phones** wizard. A list of all DECT stations appears.

Select a station -DECT Phones

Take DID from changed call number

	Box	Slot	Dect-Port	Callno	Name	DID	Fax Callno	Fax DID	Class of service
	1	2	1	2120	DECT 2120	2120	-	-	International
	1	2	2	2121	DECT 2121	2121	-	-	International
	1	2	3	2122	DECT 2122	2122	-	-	International
	1	2	4	2123	DECT 2123	2123	-	-	International
	1	2	5	2124	DECT 2124	2124	-	-	International

- 4) If you want the internal call number to be automatically assigned to the station as the direct inward dialing number, activate the radio button **Take DID from changed call number**.
- 5) If you want a different direct inward dialing number for the station than the call number, enter a DID number for the station under **DID** in the row of the desired station:
  - Only for a point-to-point connection:  
Click in the desired field and type in the DID number using the keyboard. The DID number may also be identical to the internal station number.
  - Only for a point-to-multipoint connection:  
Select an MSN in the desired field via the drop-down list. The station can be internally reached via the internal station number 101, for example, and externally via the MSN 654321.
  - For point-to-point and point-to-multipoint connections:  
Select the entry **xxx - modifiable** (xxx is the internal station number) via the drop-down list in the desired field and type in the DID number using the keyboard or select an MSN from the drop-down list.
- 6) If you want an Internet telephony phone number to be assigned to the station as the direct inward dialing number, leave the radio button **Take DID from changed call number** unselected, and select the Internet Telephony Service Provider from the list next to the radio button instead. Then select the Internet Telephony phone number from the **DID** drop-down list in the row of the desired station.
- 7) Enter the internal station number for the subscriber under **Call No** in the appropriate row of the desired subscriber. You can use the preset phone number or assign some other free number.
- 8) In the row of the desired station, under **Name**, enter a name in the format `Last Name, First Name Or First Name Last Name`.
- 9) If you want to set up a fax box for the subscriber (which can be used with the UC clients **myPortal for Desktop** or **myPortal for Outlook**, for example), proceed as follows:
  - a) In the row of the desired station, in the **Fax No.** field, enter the desired internal fax number at which the user can receive internal fax messages.
  - b) If you want to configure a DID number for the fax box, enter the desired external fax number under which the subscriber can receive external fax messages in the **Fax DID** field in the row of the desired subscriber.
- 10) Choose the desired Class of Service group in the row of the desired subscriber from the **Class of Service** drop-down list.
- 11) To add the subscriber to a call pickup group, select a call pickup group from the **Call pickup group** drop-down list in the row of the desired subscriber.
- 12) If you want to change the DECT phone code (PIN), enter the new code in the row of the desired subscriber under **Mobile code**. The DECT subscribers must log on at the base station again with this code.

**13) Make any further settings if required:**

- a) Click in the row of the desired station on the pencil icon **Edit**.

Change Station

Station	Station	Fax
Name: (for Subscriber):	<input type="text" value="DECT 2120"/>	
Call number:	<input type="text" value="2120"/>	<input type="text"/>
Direct inward dialing: (Number for Direct Inward Dialing)	<input type="text" value="2120"/>	<input type="text"/>
<b>direct inward dialing for Internet Telephony</b>		
	toplink: <input type="text" value=""/>	<input type="text" value=""/>
<b>Parameter</b>		
Device Type:	Comfort PP	
Clip/Lin:	<input type="text"/>	
Language:	<input type="text" value="German"/>	
Call signaling internal: (Ringer pitch for internal calls):	<input type="text" value="Ring type 1"/>	
Call signaling external: (Ringer pitch for external calls):	<input type="text" value="Ring type 1"/>	

- b) Select a DID number from the drop-down list in the **Direct inward dialing for Internet Telephony** area. A drop-down list is displayed for every active ITSP.

---

**INFO:** The **DID for Internet Telephony** field is not visible if Internet telephony is not configured or if no Internet Telephony Service Provider has been activated.

---

- c) In the **Clip/Lin** field, enter a phone number (DID number or MSN) to be displayed at the called party's extension instead of the own phone number in the case of an external call.

---

**INFO:** This feature must be released by the network provider.

---

- d) Select the language for the menu controls on the phone from the **Language** drop-down list.
- e) From the **Call signaling internal** drop-down list, select and assign one of a total of eight possible acoustic call signals for internal calls. The station then will then send the modified ringing tone to other internal stations, thus enabling its calls to be distinguished from other internal stations (default: Ring type 1).
- f) From the **Call signaling external** drop-down list, select and assign one of a total of three possible acoustic call signals for external calls (default: Ring type 1).
- g) Only with UC Smart: Select whether the subscriber is to receive a default mailbox or an attendant mailbox (AutoAttendant) in the **UC Smart Mailbox type** drop-down list.
- h) Only with UC Smart and default mailbox: If a caller may leave a message in the voicemail box, select the **Recording** check box.
- i) Only with UC Smart: Select a greeting from the **Greeting** drop-down list.



- j) Only with UC Smart: If the password of the voicemail box is to be reset, select the **Password Reset** check box.

---

**INFO:** The **Password Reset** check box must be cleared when setting up a new voicemail box. It is used to reset the password of the voicemail box. When a new voicemail box is created, the subscriber must change the initial password anyway when accessing his or her voicemail box for the first time.

---

- k) Click on **OK & Next**.
- l) Change the station flags as needed. For a description of the station flags, see [Station > Station > Station Parameters](#).
- m) Click on **OK & Next**.

14) If you want to configure another station, repeat steps 5 through 13.

15) Click on **OK & Next**. A list of all configured DECT stations appears. If required, you can print the list of DECT stations with **Print**.

16) Click on **OK & Next** followed by **Finish**.

## 10.12.5 How to Configure ISDN Stations

The **ISDN Devices** wizard can be used to configure the ISDN stations (e.g., ISDN phone or ISDN fax).

### Prerequisites

- At least one free S<sub>0</sub> interface is available. If one of the S<sub>0</sub> ports of a hardware platform is used, this must be set up as an internal S<sub>0</sub> port.
- You are logged on to the WBM with the **Advanced** profile.

### Step by Step

- 1) In the navigation bar, click on **Setup**.
- 2) In the navigation tree, click **Wizards > Telephones / Subscribers**.
- 3) Click on **Edit** to start the **ISDN Devices** wizard. A list of all ISDN stations appears.

Select a station -ISDN Devices

Take DID from changed call number

Box Slot	S0-Port	Callno	Name	DID	Fax Callno	Fax DID	Class of service	Call pickup
1	1	2	130	FAX ISDN	130	131	131	International

- 4) If you want the direct inward dialing number of the station to be automatically adapted to its call number, activate the radio button **Take DID from changed call number**.

- 5) If you want a different direct inward dialing number for the station than the call number, enter a DID number for the station under **DID** in the row of the desired station:
  - Only for a point-to-point connection:  
Click in the desired field and type in the DID number using the keyboard. The DID number may also be identical to the internal station number.
  - Only for a point-to-multipoint connection:  
Select an MSN in the desired field via the drop-down list. The station can be internally reached via the internal station number 101, for example, and externally via the MSN 654321.
  - For point-to-point and point-to-multipoint connections:  
Select the entry **xxx - modifiable** (xxx is the internal station number) via the drop-down list in the desired field and type in the DID number using the keyboard or select an MSN from the drop-down list.
- 6) Enter the internal station number for the subscriber under **Call No** in the appropriate row of the desired subscriber. You can use the preset phone number or assign some other free number.
- 7) In the row of the desired station, under **Name**, enter a name in the format Last Name, First Name OR First Name Last Name.
- 8) Choose one of the Class of Service groups in the row of the desired subscriber from the **Class of Service** drop-down list:
- 9) To add the subscriber to a call pickup group, select a call pickup group from the **Call pickup group** drop-down list in the row of the desired subscriber.
- 10) Make any further settings if required:
  - a) Click in the row of the desired station on the pencil icon **Edit**.

Change Station

<b>Station</b>	Name: (for Subscriber): <input type="text" value="FAX ISDN"/> Call number: <input type="text" value="130"/> Direct inward dialing: (Number for Direct Inward Dialing) <input type="text" value="130"/>
<b>direct inward dialing for Internet Telephony</b>	Siggate: <input type="text" value="49895656114"/> <input type="button" value="v"/> Application Suite: <input type="button" value="v"/>
<b>Parameter</b>	Device Type: S0 Extension Clip/Lin: <input type="text" value=""/> Access: STLS2N 1-2-1 Extension Type: <input type="text" value="Fax"/> <input type="button" value="v"/> Language: <input type="text" value="German"/> <input type="button" value="v"/> Call signaling internal: (Ringer pitch for internal calls): <input type="text" value="Ring type 1"/> <input type="button" value="v"/> Call signaling external: (Ringer pitch for external calls): <input type="text" value="Ring type 1"/> <input type="button" value="v"/>

- b) Select a DID number from the drop-down list in the **Direct inward dialing for Internet Telephony** area. A drop-down list is displayed for every active ITSP.

---

**INFO:** The **DID for Internet Telephony** field is not visible if Internet telephony is not configured or if no Internet Telephony Service Provider has been activated.

---

- c) In the **Clip/Lin** field, enter a phone number (DID number or MSN) to be displayed at the called party's extension instead of the own phone number in the case of an external call.

---

**INFO:** This feature must be released by the network provider.

---

- d) Select the type of ISDN terminal from the **Extension Type** drop-down list (Standard or Fax).
- e) Do not change the default selection in the **Language** drop-down list. This setting has no relevance for ISDN terminals.
- f) From the **Call signaling internal** drop-down list, select and assign one of a total of eight possible acoustic call signals for internal calls. The station then will then send the modified ringing tone to other internal stations, thus enabling its calls to be distinguished from other internal stations (default: Ring type 1).
- g) From the **Call signaling external** drop-down list, select and assign one of a total of three possible acoustic call signals for external calls (default: Ring type 1).
- h) Only with UC Smart: Select whether the subscriber is to receive a default mailbox or an attendant mailbox (AutoAttendant) in the **UC Smart Mailbox type** drop-down list.
- i) Only with UC Smart and default mailbox: If a caller may leave a message in the voicemail box, select the **Recording** check box.
- j) Only with UC Smart: Select a greeting from the **Greeting** drop-down list.
- k) Only with UC Smart: If the password of the voicemail box is to be reset, select the **Password Reset** check box.

---

**INFO:** The **Password Reset** check box must be cleared when setting up a new voicemail box. It is used to reset the password of the voicemail box. When a new voicemail box is created, the subscriber must change the initial password anyway when accessing his or her voicemail box for the first time.

---

- l) Click on **OK & Next**.
- m) Change the station flags as needed. For a description of the station flags, see [Station > Station > Station Parameters](#).
- n) Click on **OK & Next**.

**11)** If you want to configure another station, repeat steps 5 through 10.

12) Click on **OK & Next**. A list of all configured ISDN stations appears. If required, you can print the list of ISDN stations with **Print**.

13) Click on **OK & Next** followed by **Finish**.

## 10.12.6 How to Configure Analog Stations

You can use the **Analog Devices** wizard to configure analog stations (e.g., analog phone or fax).

### Prerequisites

- At least one free analog interface is available.
- DTMF is enabled at the analog devices.
- You are logged on to the WBM with the **Advanced** profile.

### Step by Step

- 1) In the navigation bar, click on **Setup**.
- 2) In the navigation tree, click **Wizards > Telephones / Subscribers**.
- 3) Click on **Edit** to start the **Analog Terminals** wizard. A list of all analog stations appears.

Select a station -A/B Phones									
<input checked="" type="checkbox"/> Take DID from changed call number									
Box	Slot	a/b-Port	Callno	Name	DID	Fax Callno	Fax DID	Class of service	Call pickup
	1	3	1	140	Polyspan Analog	140	-	International	-
	1	3	2	141	FAX Analog	141	142	International	-
	1	3	3	-	-	-	-	International	-
	1	3	4	-	-	-	-	International	-

- 4) If you want the direct inward dialing number of the station to be automatically adapted to its call number, activate the radio button **Take DID from changed call number**.
- 5) If you want a different direct inward dialing number for the station than the call number, enter a DID number for the station under **DID** in the row of the desired station:
  - Only for a point-to-point connection:  
Click in the desired field and type in the DID number using the keyboard. The DID number may also be identical to the internal station number.
  - Only for a point-to-multipoint connection:  
Select an MSN in the desired field via the drop-down list. The station can be internally reached via the internal station number 101, for example, and externally via the MSN 654321.

- For point-to-point and point-to-multipoint connections:  
Select the entry **xxx - modifiable** (xxx is the internal station number) via the drop-down list in the desired field and type in the DID number using the keyboard or select an MSN from the drop-down list.
- 6) Enter the internal station number for the subscriber under **Call No** in the appropriate row of the desired subscriber. You can use the preset phone number or assign some other free number.
  - 7) In the row of the desired station, under **Name**, enter a name in the format Last Name, First Name OR First Name Last Name.
  - 8) Choose one of the Class of Service groups in the row of the desired subscriber from the **Class of Service** drop-down list:
  - 9) To add the subscriber to a call pickup group, select a call pickup group from the **Call pickup group** drop-down list in the row of the desired subscriber.
  - 10) Make any further settings if required: - For an analog modem, the station type **Modem** must be selected here:
    - a) Click in the row of the desired station on the pencil icon **Edit**.

Change Station

<b>Station</b>	Name: (for Subscriber): FAX Analog
	Call number: 141
	Direct inward dialing: (Number for Direct Inward Dialing) 141
<b>direct inward dialing for Internet Telephony</b>	Sipgate: 4989565656115
	Application Suite:
<b>Parameter</b>	Device Type: analog
	Clip/Lin: -
	Access: 4SLAV 3-2
	Extension Type: Fax
	Language: German
	Call signaling internal: (Ringer pitch for internal calls): Ring type 1
	Call signaling external: (Ringer pitch for external calls): Ring type 1

- b) Select a DID number from the drop-down list in the **Direct inward dialing for Internet Telephony** area. A drop-down list is displayed for every active ITSP.

---

**INFO:** The **DID for Internet Telephony** field is not visible if Internet telephony is not configured or if no Internet Telephony Service Provider has been activated.

---

- c) In the **Clip/Lin** field, enter a phone number (DID number or MSN) to be displayed at the called party's extension instead of the own phone number in the case of an external call.

---

**INFO:** This feature must be released by the network provider.

---

- d)** Select the analog terminal type (fax, for instance) in the **Extension Type** drop-down list.  
  
If an analog modem is to be set up, the station type **Modem** must be selected here.
- e)** Do not change the default selection in the **Language** drop-down list. This setting has no relevance for analog terminals.
- f)** From the **Call signaling internal** drop-down list, select and assign one of a total of eight possible acoustic call signals for internal calls. The station then will then send the modified ringing tone to other internal stations, thus enabling its calls to be distinguished from other internal stations (default: Ring type 1).
- g)** From the **Call signaling external** drop-down list, select and assign one of a total of three possible acoustic call signals for external calls (default: Ring type 1).
- h)** Only with UC Smart: Select whether the subscriber is to receive a default mailbox or an attendant mailbox (AutoAttendant) in the **UC Smart Mailbox type** drop-down list.
- i)** Only with UC Smart and default mailbox: If a caller may leave a message in the voicemail box, select the **Recording** check box.
- j)** Only with UC Smart: Select a greeting from the **Greeting** drop-down list.
- k)** Only with UC Smart: If the password of the voicemail box is to be reset, select the **Password Reset** check box.

---

**INFO:** The **Password Reset** check box must be cleared when setting up a new voicemail box. It is used to reset the password of the voicemail box. When a new voicemail box is created, the subscriber must change the initial password anyway when accessing his or her voicemail box for the first time.

---

- l)** Click on **OK & Next**.
  - m)** Change the station flags as needed. For a description of the station flags, see [Station > Station > Station Parameters](#).
  - n)** Click on **OK & Next**.
- 11)** If you want to configure another station, repeat steps **5** through **10**.
- 12)** Click on **OK & Next**. A list of all configured analog stations appears. If required, you can print the list of analog stations with **Print**.
- 13)** Click on **OK & Next** followed by **Finish**.

## 10.12.7 How to Edit Station Names

The **Station Name and Release** wizard can be used to edit the names of stations.

**Prerequisites**

- You are logged in at the WBM.

**Step by Step**

- 1) In the navigation bar, click on **Setup**.
- 2) In the navigation tree, click **Wizards > User Telephony**.
- 3) Click on **Edit** to start the **Station Name and Release** wizard.

Name Configuration and Unlock for Stations and Groups		
Call number	Name	System telephone lock reset
**555	Mobil	Function not available
100	Andreas Richter	<input type="checkbox"/>
101	Susanne Mueller	<input type="checkbox"/>
102	Buddy Miller	<input type="checkbox"/>
103	Janet Jones	<input type="checkbox"/>
110	Natalie Dubois	<input type="checkbox"/>
111	Pierre Martin	<input type="checkbox"/>
112	Claudia Ferraro	<input type="checkbox"/>
113	Giovanni Rossi	<input type="checkbox"/>
114	Carlos Alvarez	<input type="checkbox"/>
115	Emilia Gonzales	<input type="checkbox"/>
120	Isabel Ferreira	<input type="checkbox"/>
121	Paolo DaSilva	<input type="checkbox"/>
122	Ivan VanDenBerg	<input type="checkbox"/>

- 4) Click in the **Name** column in the field of the desired subscriber and edit a subscriber name in the format Last Name, First Name or First Name Last Name.
- 5) If you want to edit the names of further stations, repeat step 4.
- 6) Click on **OK & Next**, followed by **Finish**.

## 10.13 Configuring Station Profiles

The values and properties of IP stations are stored in station profiles.

Using the **Profiles** wizard, an administrator with the **Advanced** profile can perform the following configuration tasks:

- Create a new profile
- Display profiles and their members
- Add members to a profile
- Delete members from a profile
- Export or import a single profile

In Expert mode, an administrator with the **Expert** profile can also perform the following configuration tasks:

- Change values and settings of a station profile
- Export or import all profiles

Station profiles that have already been created cannot be deleted, but can be overwritten.

### 10.13.1 How to Create a New Station Profile

#### Prerequisites

- You are logged on to the WBM with the **Advanced** profile.

#### Step by Step

- 1) In the navigation bar, click on **Setup**.
- 2) In the navigation tree, click **Wizards > User Telephony**.
- 3) Click on **Edit** to start the **Station Profiles** wizard. All existing station profiles are displayed.

Station Profiles		Profile	Name
Assign Stations	Import/Export Profile	Profile-1	<input type="text" value="Profil OSBiz 1"/>
Assign Stations	Import/Export Profile	Profile-2	<input type="text" value="-"/>
Assign Stations	Import/Export Profile	Profile-3	<input type="text" value="-"/>
Assign Stations	Import/Export Profile	Profile-4	<input type="text" value="-"/>
Assign Stations	Import/Export Profile	Profile-5	<input type="text" value="-"/>
Assign Stations	Import/Export Profile	Profile-6	<input type="text" value="-"/>
Assign Stations	Import/Export Profile	Profile-7	<input type="text" value="-"/>
Assign Stations	Import/Export Profile	Profile-8	<input type="text" value="-"/>
Assign Stations	Import/Export Profile	Profile-9	<input type="text" value="-"/>
Assign Stations	Import/Export Profile	Profile-10	<input type="text" value="-"/>
Assign Stations	Import/Export Profile	Profile-11	<input type="text" value="-"/>
Assign Stations	Import/Export Profile	Profile-12	<input type="text" value="-"/>

- 4) In the row of the desired station profile, in the **Name** column, enter a name of your choice for the profile (max. 16 characters).
- 5) Click **Assign Stations** in the row of the desired station profile.





- 6) Select the desired members from the **Profile Members** table (multiple selections are allowed) and click on **Add**. These stations are now assigned to the station profile and cannot be assigned to any further station profile.
- 7) Click on **OK**.
- 8) Click on **OK & Next**. All existing station profiles and their members are displayed.
- 9) Click on **OK & Next** followed by **Finish**.

## 10.13.2 How to Display Station Profiles and their Members

### *Prerequisites*

- You are logged on to the WBM with the **Advanced** profile.

### *Step by Step*

- 1) In the navigation bar, click on **Setup**.
- 2) In the navigation tree, click **Wizards > User Telephony**.
- 3) Click on **Edit** to start the **Station Profiles** wizard. All existing station profiles are displayed.
- 4) Click on **OK & Next**. All existing station profiles and their members are displayed.

## 10.13.3 How to Add Members to a Station Profile

### *Prerequisites*

- You are logged on to the WBM with the **Advanced** profile.

**Step by Step**

- 1) In the navigation bar, click on **Setup**.
- 2) In the navigation tree, click **Wizards > User Telephony**.
- 3) Click on **Edit** to start the **Station Profiles** wizard. All existing station profiles and their members are displayed.
- 4) Click **Assign Stations** in the row of the desired station profile.

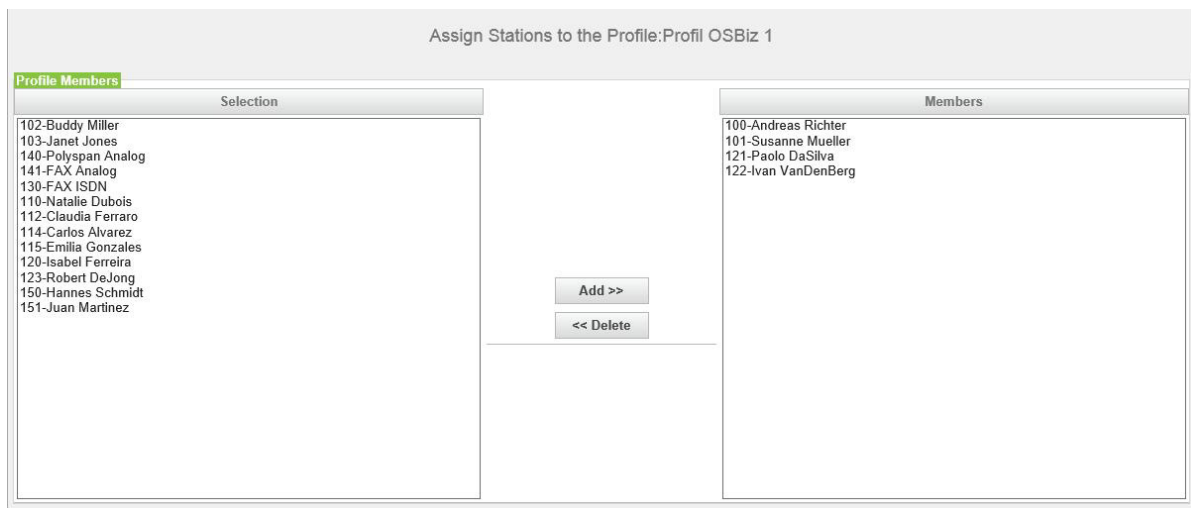

- 5) Select the desired members from the **Profile Members** list (multiple selections are allowed) and click on **Add**. These stations are now assigned to the station profile and cannot be assigned to any further station profile.
- 6) Click on **OK**.
- 7) Click on **OK & Next**. All existing station profiles and their members are displayed.
- 8) Click on **OK & Next** followed by **Finish**.

### 10.13.4 How to Delete Members from a Station Profile

**Prerequisites**

- You are logged on to the WBM with the **Advanced** profile.

**Step by Step**

- 1) In the navigation bar, click on **Setup**.
- 2) In the navigation tree, click **Wizards > User Telephony**.
- 3) Click on **Edit** to start the **Station Profiles** wizard. All existing station profiles and their members are displayed.
- 4) Click **Assign Stations** in the row of the desired station profile.

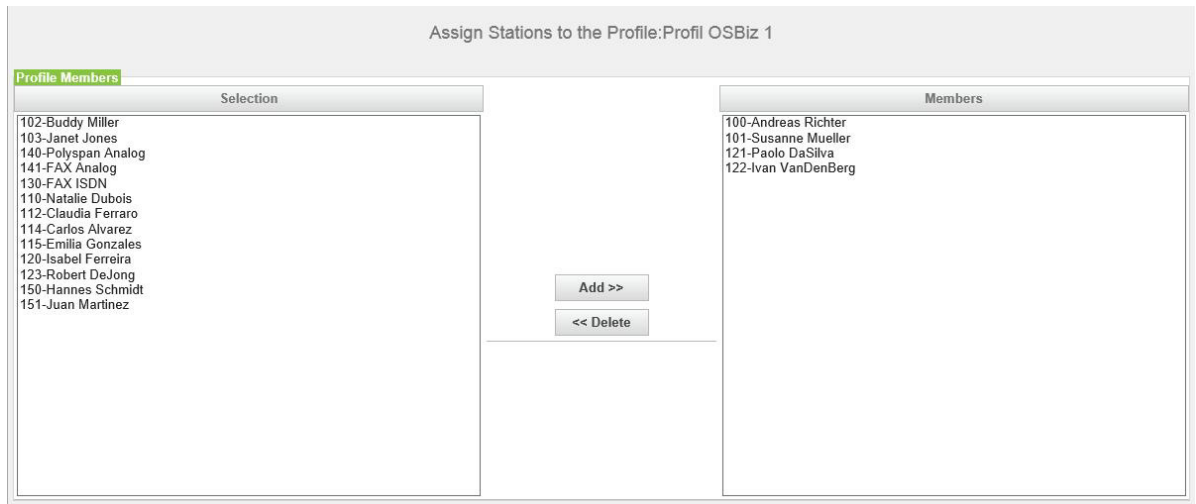

- 5) Select the desired members from the **Members** list (multiple selections are allowed) and click on **Delete**. These subscribers can now be reassigned to another station profile.
- 6) Click on **OK**.
- 7) Click on **OK & Next**. All existing station profiles and their members are displayed.
- 8) Click on **OK & Next** followed by **Finish**.

## 10.13.5 How to Export or Import a Single Station Profile

### Prerequisites

- You are logged on to the WBM with the **Advanced** profile.

### Step by Step

- 1) In the navigation bar, click on **Setup**.
- 2) In the navigation tree, click **Wizards > User Telephony**.
- 3) Click on **Edit** to start the **Station Profiles** wizard. All existing station profiles and their members are displayed.
- 4) Click **Import/Export Profile** in the row of the desired station profile.
- 5) If you want to export the station profile to a file, click on **Download** and save the file in a directory of your choice.
- 6) If you want to import a station profile from a file, click **Browse**, navigate to the storage location of the file and load the file into the communication system.
- 7) Click on **OK**.
- 8) Click on **OK & Next**. All existing station profiles and their members are displayed.
- 9) Click on **OK & Next** followed by **Finish**.

## 10.13.6 How to Change Values and Settings of a Station Profile

### Prerequisites

- You are logged into the WBM with the **Expert** profile.

### Step by Step

- In the navigation bar, click on **Expert Mode**.
- In the navigation tree, click **Telephony > Stations**.
- In the menu tree, click **Stations > Profiles/Templates**.
- In the menu tree, click on a station profile number (1156-1175).

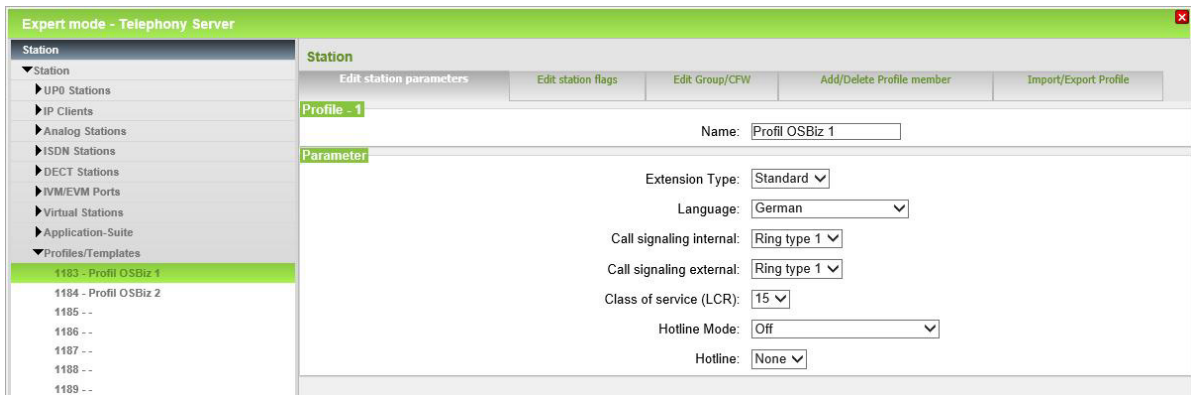

- If required, edit the name of the station profile (up to 16 characters are possible) on the **Station Parameters** tab in **Name** field and click **Apply**.
- If required, edit the desired station parameters for the station profile on the **Station Parameters** tab and click **Apply**.

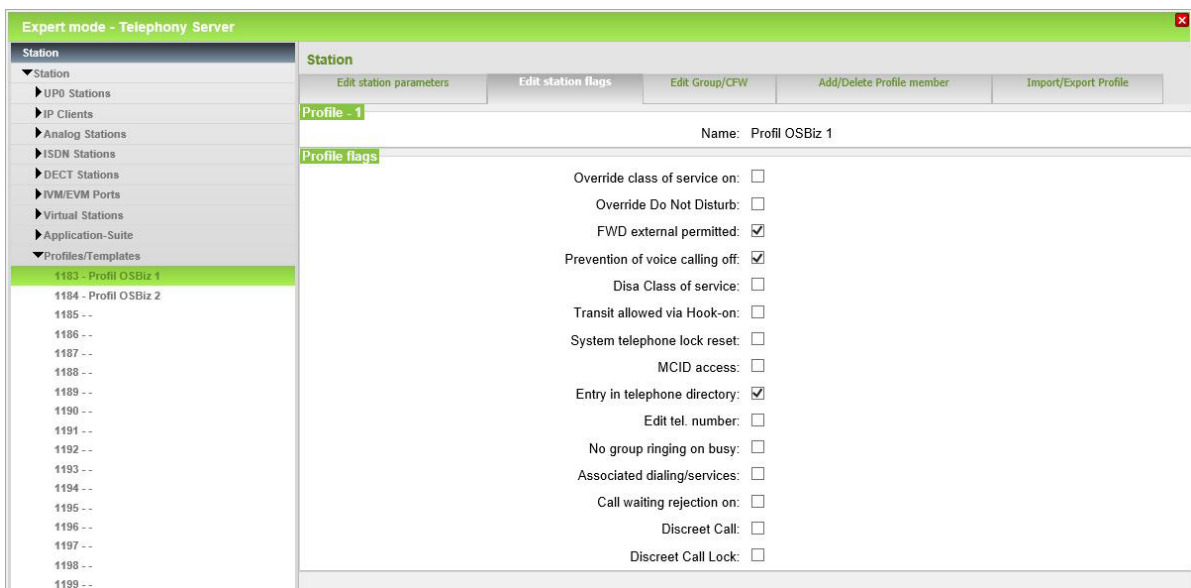

- 7) If required, edit the desired station flags for the station profile on the **Station Flags** tab and click **Apply**.

- 8) If required, edit the desired call forwardings for the station profile on the **Groups/RNA** tab and click **Apply**.
- 9) Click on **Apply**.

## 10.13.7 How to Export or Import all Station Profiles

### Prerequisites

- You are logged into the WBM with the **Expert** profile.

### Step by Step

- In the navigation bar, click on **Expert Mode**.
- In the navigation tree, click **Telephony > Stations**.
- In the menu tree, click **Stations > Profiles/Templates**.
- Click on the **Import/Export All Profiles** tab.
- If you want to export all station profiles to a file, click on **Download** and save the file in a directory of your choice.
- If you want to import all station profiles from a file, click **Browse**, navigate to the storage location of the file and load the file into the communication system.

## Stations

Configuring the Authentication Data at the SIP Phone

# 10.14 Configuring the Authentication Data at the SIP Phone

The data used to authenticate a SIP subscriber at the communication system must also be entered directly at the SIP phone. This must be done by using the data that was entered in the WBM for each SIP subscriber.

The following data must be taken from the WBM and entered at the SIP phone (separately for each SIP phone):

- Password  
Password for authentication.
- SIP User ID / Username  
User name for authentication.
- Realm  
Zone or domain for authentication.

The configuration can be performed via the WBM of the SIP phone or directly on the display of the SIP phone.

## 10.14.1 How to Configure the Authentication Data via the WBM of the SIP Phone

### Prerequisites

- The SIP phone is integrated in the LAN.
- The admin PC has access to the WBM of the SIP telephone.
- You know the IP address of the SIP phone.
- The configuration uses an OpenStage 60 SIP as an example.

### Step by Step

- 1) Start the web browser on the admin PC and open the login page of the WBM of the SIP telephone at the following address:

```
https://<IP address of the SIP telephone>
```

---

**INFO:** If the WBM cannot be started, check the LAN connection and repeat the call. If it still cannot be started, check whether the IP address has been blocked by your firewall. More detailed information can be found in the documentation of your firewall

---

- 2) If the browser reports a problem with a security certificate, install the certificate (using the example of Internet Explorer V10).
  - a) Close the web browser.
  - b) Open the web browser with administrator rights by clicking the right mouse button on the web browser icon and selecting the menu item **Run as administrator** from the context menu.

- c) Allow the User Account Control.
  - d) Open the login page of the WBM of the SIP telephone at the following address:  

```
https://<IP address of the SIP telephone>
```
  - e) Click on **Continue to this website**.
  - f) Click on the message **Certificate Error** in the navigation bar of the web browser.
  - g) Click on **View Certificates**.
  - h) Click on **Install Certificate** (only visible with administrator rights).
  - i) Select the option **Local Computer** and confirm with **Next**.
  - j) Select the option **Place all certificates in the following store**, click **Browse** and specify **Trusted Root Certification Authorities**.
  - k) Confirm with **OK** and then with **Next** and **Finish**.
  - l) Confirm the certificate import with **OK** and close the certificate window **OK**.
  - m) Close the web browser.
  - n) Start the web browser again (without administrator rights) and open the login page of the WBM of the SIP telephone at the following address:  

```
https://<IP address of the SIP telephone>
```
- 3) When you log in for the first time, you are prompted to enter a password.
- a) Enter a new password in the **New Password** and **Confirm Password** fields to protect the system against misuse. Note case usage and the status of the **Num** key. The password is displayed as a string of asterisks (\*).
- 
- INFO:** The password must be at least 6 characters long and include a digit. Make sure that you remember your new password.
- 
- 4) Click on **OK**.
  - 5) Click on the **Administrator Pages (Admin)** tab.
  - 6) Enter the administrator password (default password: 123456) and click **Login**.
  - 7) Navigate to **System > Registration**.

## Stations

### Configuring the Authentication Data at the SIP Phone

Registration	
<b>SIP Addresses</b>	
SIP server address	192.168.1.2
SIP registrar address	192.168.1.2
SIP gateway address	192.168.1.2
<b>SIP Session</b>	
Session timer enabled	<input type="checkbox"/>
Session duration (seconds)	0
Registration timer (seconds)	3600
Server type	Genesys
Realm	SMART-SIP
User ID	SIP-120
Password	••••••
MLPP base	Local
MLPP Domain	dsn+uc
Other Domain	
<b>SIP Survivability</b>	
Backup registration allowed	<input checked="" type="checkbox"/>
Backup proxy address	
Backup registration timer (seconds)	3600
Backup transport	UDP
Backup OBP flag	<input type="checkbox"/>
<input type="button" value="Submit"/> <input type="button" value="Reset"/>	

- 8) Select the entry **Genesys** from the **Server type** drop-down list in the **SIP Session** area.
- 9) In the **Realm** field, enter the realm entry that you specified when configuring SIP stations in the WBM of the communication system (e.g., `SMART-SIP`).
- 10) In the **User ID** field, enter the user ID that you specified when configuring SIP stations in the WBM of the communication system (e.g., `SIP-120`).
- 11) In the **Password** field, enter the password that you specified when configuring SIP stations in the WBM of the communication system.
- 12) Click on **Submit**. The changes are saved.
- 13) Log out from the WBM with the **Logoff** button.

## 10.14.2 How to Configure the Authentication Data on the Display of the SIP Phone

### Prerequisites

- The required authentication data (user ID, password, and realm) is known to you.
- The configuration uses an OpenStage 80 SIP as an example.



### **Step by Step**

- 1) To reach the administration mode of the system telephone, press the appropriate key for the `Settings/Applications` menu on the phone.
- 2) Scroll through the `Settings` options until `Admin` and confirm this with the OK key.
- 3) Enter administrator password (123456 by default) and confirm your selection with the OK key.
- 4) Scroll to `System` and confirm your selection with the OK key.
- 5) Scroll to `Registration` and confirm your selection with the OK key.
- 6) Scroll to `SIP Session` and confirm your selection with the OK key.
- 7) Scroll to `Server type` and confirm your selection with the OK key.
- 8) Scroll to the `Genesys` entry and confirm your selection with the OK key.
- 9) Scroll to `Realm` and confirm your selection with the OK key.
- 10) Enter the realm entry that you specified when configuring SIP stations in the WBM of the communication system (e.g., `SMART-SIP`). Click OK to confirm.
- 11) Scroll to `User ID` and confirm your selection with the OK key.
- 12) Enter the user ID that you specified when configuring SIP stations in the WBM of the communication system (e.g., `SIP-120`). Click OK to confirm.
- 13) Scroll to `Password` and confirm your selection with the OK key.
- 14) Enter the password that you specified when configuring SIP stations in the WBM of the communication system. Click OK to confirm.
- 15) After saving the changes, confirm the prompt by selecting `Save select` and confirming it with the OK button.
- 16) Use the Back key to go back to the `Admin` menu.
- 17) If the system telephone needs to be restarted due to the changes made, the menu item `Restart` will appear in the `Admin` menu. Confirm the `Restart` with the OK key and then also confirm `Yes` with the OK key. The system telephone performs a reboot and logs in to the communication system.

## **10.15 Exporting Subscriber Data**

Important subscriber data can be exported to an XML file.

In addition to the user data, such as the names and phone numbers of the subscribers, e-mail addresses and phone types, for example, the XML file may also contain additional information such as group phone numbers and license assignments.

The XML file can be edited using a spreadsheet program such as Microsoft Office Excel, for example.

A template with sample data sets and a description thereof can be found in the file `csv-templates.zip` under **Service Center > Documents > CSV Templates**.

## 10.15.1 How to Export the Station Data

### *Prerequisites*

- You are logged into the WBM with the **Expert** profile.

### *Step by Step*

- 1) In the navigation bar, click on **Expert Mode**.
- 2) Click **Maintenance > Configuration** in the navigation tree.
- 3) Click on **Configuration > Port Configuration** in the menu tree.
- 4) Click on the **Export Configuration** tab.
- 5) Click on the **Download** button.
- 6) Confirm the prompt with **OK**.
- 7) Click on **Save** and select the storage location of the XML file.
- 8) Then click **Save**.

# 11 UC Smart

UC Smart is integrated in all OpenScape Business models (with and without the UC Booster) and offers unified communications features such as presence status and voice messages as well as conferencing, for example.

## Clients for UC Smart

The UC Smart features can be used with the following clients:

- myPortal Smart
- myPortal to go (as Mobile UC App or Web Edition)
- myPortal for OpenStage
- Application Launcher
- OpenScape Business Attendant / BLF
- 3rd Party WSI Clients

The capacity limits (for expansion) depend on the OpenScape Business model being used and any possibly installed OpenScape Business UC Booster variants.

## Special Aspects of UC Smart with OpenScape Business S

Due to the system architecture, the following restrictions apply to OpenScape Business S:

- The number of voicemail messages is not shown on the phone's display (MWI).
- No fax, busy or idle detection is supported for the voicemail box (SmartVM). Incoming fax calls cannot be switched to a default fax device after being answered by the SmartVM. The SmartVM records for 2 minutes.
- When connections are switched by the Company AutoAttendant to busy subscribers, the caller receives a busy signal. There is no way to leave a voice message.
- If, when checking a voice message, you want to be redirected to the phone number stored in the SmartVM (calling party number), this number must be identical to the phone number of the user that was configured for the SmartVM.
- For connections to the voicemail box (SmartVM), SIPQ trunks are occupied at the UC Booster Server and OpenScape Business S. No trunk licenses are required for this.
- MEB channels are occupied for simultaneous announcements.
- Sixty MEB channels are available for voice connections to the voicemail box (SmartVM) or AutoAttendant.

---

**INFO:** After changes in configuration of Stations, Groups, Mobility or other system parameters like trunk access codes, the UC Data for either UC Smart or UC Suite need to be synchronized. Synchronization occurs five minutes after the last configuration change. If a later configuration change occurs before the 5 minutes timer, the timer is restarted. UC Data may outdated until

synchronization starts. During the synchronization the UC Application and the Web Services Interface API are not available and any connected UC clients lose their connection until UC Data synchronization is finished. Connections are restored automatically after UC Data Synchronization is finished.

---

---

#### **Related Topics**

- [UC Features \(Overview\)](#)

## **11.1 Basic Settings for UC Smart**

The basic settings for UC Smart can be customized.

UC Smart can be enabled or disabled. If UC Smart is used, UC Suite must be disabled.

#### **Password Settings**

The administrator must assign an initial password for all users of UC Smart and communicate this password to the users. The initial password may be the same for all users or different for each user. The initial password must be changed by the user when logging in at a UC Smart client for the first time. Without the assignment of an initial password, the user cannot log into a UC Smart client.

The new password assigned by the user should meet stringent password policies.

#### **Advanced Settings for Application-controlled Conferences (Optional)**

During the basic installation, the administrator must set up the **Functional number for MeetMe Conferencing** (MeetMe dial-in number) and at least one **Functional number for Conferencing** (conference room) in the WBM.

For OpenScape Business X systems, the MeetMe dial-in number must be assigned a call destination list in which the first entry is empty and the second entry matches the call number of the voicemail box (SmartVM).

For OpenScape Business S systems, the MeetMe dial-in number must be assigned a call destination list in which the first entry matches the call number of the voicemail box (Route: Application Suite).

Finally, the MeetMe dial-in number must also be assigned a standard voicemail box.

The description of the configuration can be found here: [How to Configure Application-controlled Conferences](#),

#### **License Assignments**

The administrator must assign a UC Smart User license to each UC Smart user.

Additional licenses can be optionally assigned for:

- Voicemail (also usable without UC Smart)

- Conference
- Application Launcher

## 11.1.1 How to Activate UC Smart

### *Prerequisites*

- You are logged into the WBM with the **Expert** profile.

### *Step by Step*

- 1) In the navigation bar, click on **Expert Mode**.
- 2) Click in the navigation tree on **Applications > Application Selection**.
- 3) If you want to use UC Smart without the UC Booster Server, click on **Package with UC Smart**,
- 4) If want to use UC Smart with the UC Booster Server, click on **Package with UC Smart on OSBiz UC Booster Server** and, in addition, enter the IP address of the external Linux server in the **IP address of the OSBiz UC Booster Server** field.
- 5) Click on **Apply**.

### *Next steps*

How to Configure UC Smart

## 11.1.2 How to Configure UC Smart

### *Prerequisites*

- You are logged on to the WBM with the **Advanced** profile.
- The **Package with UC Smart** has been activated under **Application Selection** in Expert mode.

### *Step by Step*

- 1) In the navigation bar, click on **Setup**.
- 2) In the navigation tree, click on **Wizards > UC Smart**.
- 3) Click on **Edit** to start the **UC Smart** wizard.
- 4) Click on **Administration > Basic Settings** in the menu tree.
- 5) Under **Enable / Disable UC Smart**, select the check box **Active**.
- 6) Assign initial password under **Password Policy**:
  - a) Go to **System-wide initial UC Smart Password**, and click **Configure**.
  - b) Enter the initial password for all UC Smart users in the **System-wide initial UC Smart password** field..

c) Click on **Apply**.

7) Specify password policies under **Password Policy**:

---

**INFO:** For detailed information on the password policies, click on the icon **i**.

---

- If you want to enforce a strict password policy for user passwords (recommended), select the check box **Force user to choose secure password**.
- If you do not want to enforce a strict password policy for user passwords (not recommended), clear the check box **Force user to choose secure password**.

8) Specify access to the system under **Access Rules**:

- If you want to enable encrypted access from UC Smart clients to the system (recommended when using myPortal to go via the Internet), select the **HTTPS** check box.
- If you want to enable unencrypted access from UC Smart clients to the system (not recommended when using myPortal to go via the Internet), select the **HTTP** check box.

9) Select the check box **Save login data for devices** if the login credentials are to be additionally stored in the phone.

10) Click on **Apply**.

### 11.1.3 How to Configure Application-controlled Conferences

#### *Prerequisites*

- You are logged on to the WBM with the **Advanced** profile.
- The **Package with UC Smart** has been activated under **Application Selection** in Expert mode.

#### *Step by Step*

- 1) In the navigation bar, click on **Setup**.
- 2) Click on **Edit** to start the **Basic Installation** wizard.
- 3) Skip the **Overview** window with **OK & Next**. The **Central Functions for Stations** window appears.
- 4) Enable the radio button **Change pre-configured call and functional numbers**.
- 5) Click **Execute function**. The **Change preconfigured call and functional numbers** window appears.
- 6) If necessary, change the **Functional number for MeetMe Conferencing** to suit your requirements.

- 7) Assign at least one **Functional number for Conferencing** for the conference room.
- 8) Click **OK** when finished. You are taken back to the **Central Functions for Stations** window.
- 9) Click **OK & Next**.
- 10) Exit the wizard by skipping all other windows with **OK & Next**.
- 11) In the navigation bar, click on **Expert Mode**.
- 12) In the navigation tree, click **Telephony Server > Incoming Calls**.
- 13) Click **Incoming Calls > Call Forwarding** in the menu tree.
- 14) Click on the **Call dest. list - Definition** tab.
- 15) For OpenScape Business X, you define the call destination list for the MeetMe dial-in number as follows:
  - a) Under **Call dest. list**, select a free call destination list, e.g., 500.
  - b) Select **No entry** as the first destination and select the call number of the voicemail box (e.g., 351 VOICEMAIL Group) as the second destination.
- 16) For OpenScape Business S., you define the call destination list for the MeetMe dial-in number as follows:
  - a) Under **Call dest. list**, select a free call destination list, e.g., 500.
  - b) Select External Destination as First Destination (Route: Application Suite) and enter the call number of the voicemail box in "External Destination" field.
- 17) Click on **Apply** followed by **OK**.
- 18) Close the window.
- 19) In the navigation bar, click on **Expert Mode**.
- 20) Click on **Telephony > Auxiliary Equipment** in the navigation tree.
- 21) Click on **Auxiliary Equipment > SmartVM** in the menu tree.
- 22) Click on the **Edit SmartVM Mailboxes** tab.
- 23) In the **Mailbox call no.** column, enter the MeetMe dial-in number for which the mailbox is to be added in any free field.
- 24) Click on **Apply** followed by **OK**.

## 11.1.4 How to Determine the IP Addresses of the System Components

### *Prerequisites*

- You are logged into the WBM with the **Expert** profile.

### Step by Step

- 1) In the navigation bar, click on **Expert Mode**.
- 2) Click in the navigation tree on **Applications > Application Selection**.

Under **Application Selection**, the IP addresses of various components are shown, including, for example, **UC Smart, Application Launcher, CSTA Connector, Open Directory Service, UC Suite / XMPP, GateView** and **Web Collaboration**.

## 11.1.5 How to Determine the Status of C Smart

### Prerequisites

- You are logged on to the WBM with the **Advanced** profile.
- The **Package with UC Smart** has been activated under **Application Selection** in Expert mode.

### Step by Step

- 1) In the navigation bar, click on **Setup**.
- 2) In the navigation tree, click on **Wizards > UC Smart**.
- 3) Click on **Edit** to start the **UC Smart** wizard.
- 4) Click on **Administration > Status** in the menu tree.

Status information on UC Smart is displayed under **Application Server**, including, for example: **Status, Version, Telephone System, Database, EVM, Pending Monitors, Active Users, Active Connections, Active HTTPS Connections, Mobility Entry Users, Users Without Device** and **Blocked Users**.

## 11.2 UC Smart Clients

UC Smart clients provide subscribers with convenient user interfaces for unified communications.

The system offers the following UC Smart clients for the following devices:

Client type	Client	Device
Communications Client	myPortal Smart	PC
	myPortal for OpenStage (UC Smart)	OpenStage telephone
Mobile Client	myPortal to go (UC Smart) (see <a href="#">Mobility</a> )	Smartphone, Tablet PC
Communications Client	OpenScape Desk Phone CP 400/600 HFA(integrated Client to phone software)	OpenScape Desk Phone CP 400/600 HFA



## 11.2.1 myPortal Smart

myPortal Smart is an Adobe AIR-based PC application (Microsoft Windows and Mac OS X) for unified communications using the UC solution UC Smart. Besides convenient dialing aids via phone directories and favorites and information on the presence status of colleagues, you can, for example, also access your voicemails.

Depending on the licenses assigned to you, the scope of the available features may vary slightly.

myPortal Smart supports the following features:

- Presence status
- Status-based call forwarding
- Directories
- Favorites List
- Journal
- Search by phone number and name
- Call Functions
- One Number Service (ONS)
- Voicemail
- Text messages

---

**INFO:** Some features such as consultation holds and conferencing are not available in myPortal Smart in conjunction with SIP telephones.

---

## 11.2.2 myPortal for OpenStage

myPortal for OpenStage is the user portal for accessing unified communications functions on your system telephone.

The configuration of myPortal for OpenStage is possible directly on the system telephone via the administrator settings or via the WBM of the system telephone.

myPortal for OpenStage provides the following features:

- Presence status

## 11.2.3 Prerequisites for myPortal Smart

In order to use the UC client, the client PC must be equipped with the appropriate hardware and software configurations. Depending on the configuration, administration rights are required for the installation and automatic updates. The available functionality depends on the licenses being used.

---

**INFO:** Please make sure that you refer to the latest information in the Experts wiki.

---

---

**INFO:** In case of Windows OS, TLS 1.2 in Internet Options (in control panel) must be activated and the latest patches from Microsoft must be installed or activated manually.

If above actions are not performed then HTTPS access will be rejected.

---

### Telephones

myPortal Smart can be used in combination with the following telephones:

- OpenStage HFA and SIP
- OpenScape Desk Phone IP 35G/55G HFA and SIP
- OpenScape Desk Phone IP 35G Eco HFA and SIP
- OpenScape Desk Phone CP 200/205/400/600 HFA and SIP
- SIP phones with 3PCC support
- Analog telephones
- ISDN Phones
- OpenScape Personal Edition HFA and SIP
- OpenStage S5/M3/SL4 (OpenScape Business Cordless)
- optiPoint WL3 professional SIP

Older devices (such as optiPoint 410/420/500, Gigaset M2/SL3/S4 and optiPoint WL2 SIP) are supported. Optiset E devices cannot be operated. For details on the tested and released devices, please refer to the Release Notice.

---

**INFO:** OpenScape Desk Phone CP 400/600 HFA integrated Client does not have any special prerequisites, apart from the standard client configuration and license.

"Favorites" in phone menu contains Free Programmable Keys and does not relate to UC Favorites. Details for those keys and how to, are available within the device documentation.

---

---

**INFO:** Some features such as consultation holds and conferencing are not available in myPortal Smart in conjunction with SIP telephones.

---

---

**INFO:** For analog and DECT telephones, the Message Waiting Indication (MWI) is not supported, and only limited support is available for displaying information on the phone.

---

#### Additional Software

- Adobe AIR V16.0 or later

#### Minimum Hardware Requirements

According to the requirements of Adobe AIR.

#### Web Browsers

The following web browsers have been released for programming telephone keys via the UC client:

- Microsoft Internet Explorer Version 10 (or later)
- Mozilla Firefox Version 19 (or later)
- Google Chrome

#### Installation Files

The administrator can download the installation files from the **Service Center > Software** and make them available to users via a network drive, for example.

---

#### Related Topics

- [Licenses](#)

## 11.2.4 Prerequisites for myPortal for OpenStage

In order to use myPortal for OpenStage, the phone must be equipped with the appropriate hardware and software.

#### Telephones

myPortal for OpenStage can be used with the following telephones:

- OpenStage 60/80
- OpenScape Desk Phone IP 55G

#### Web Browsers

myPortal for OpenStage can be used in combination with the following web browsers (for configuration and administration):

- Microsoft Internet Explorer Version 10 (or later)
- Mozilla Firefox Version 19 (or later)
- Google Chrome

## 11.3 Users of UC Smart

Users of UC Smart are subscribers who use the UC Clients of UC Smart.

The following settings for UC Smart clients are available in UC Smart Assistant:

Settings	Explanation
<b>Settings</b>	
Users	The setting is only displayed here.
Name	The setting is only displayed here.
Password	Password for UC Smart clients and UC Smart Assistant.
Language	Language of the user interface.
The user must assign a new password	The setting is only displayed here.
UC Smart Assistant access	User permission for the use of UC Smart Assistant in the web browser for configuration tasks.
Configured as Mobility stations	The setting is only displayed here.
Voicemail licence	The setting is only displayed here.
Associated Services	The setting is only displayed here.
<b>Profile details</b>	
Mobile phone number	Mobile phone number of the subscriber in canonical format (e.g., + 49 173 1234567).
Private/External phone number	Additional phone number of the subscriber in canonical format (e.g., + 49 89 987654321).
E-mail Address	E-mail address of the subscriber.
Voicemail to e-mail	Enable/disable the e-mail notification when a new voice message is received.
Presence visibility	Setting that determines whether the presence status is visible to both internal and external subscribers or just to internal subscribers or not visible to any subscribers.
<b>Licence information</b>	
Display of licenses assigned to the user	

## 11.3.1 How to Configure UC Smart Users

### *Prerequisites*

- You are logged on to the WBM with the **Advanced** profile.
- The **Package with UC Smart** has been activated under **Application Selection** in Expert mode.

### *Step by Step*

- 1) In the navigation bar, click on **Setup**.
- 2) In the navigation tree, click on **Wizards > UC Smart**.
- 3) Click on **Edit** to start the **UC Smart** wizard.

- 4) Click on **Administration > User Management** in the menu tree.
- 5) Select the desired user in the **Users** list.
- 6) Enter the data of the user in the **Settings** area and the **Profile Details** area.
- 7) Click **Apply**.
- 8) If you want to configure another user, repeat steps 5 through 7.

## 11.3.2 How to Change the Password for a UC Smart User

### Prerequisites

- You are logged on to the WBM with the **Advanced** profile.
- The **Package with UC Smart** has been activated under **Application Selection** in Expert mode.

---

**INFO:** Please note that a UC Smart user must change his or her password again by default after the administrator has changed it. If this is not desired, the flag "User must change the password" must be disabled after changing the password.

---

### Step by Step

- 1) In the navigation bar, click on **Setup**.
- 2) In the navigation tree, click on **Wizards > UC Smart**.
- 3) Click on **Edit** to start the **UC Smart** wizard.
- 4) Click on **Administration > User Management** in the menu tree.
- 5) Select the relevant user in the **Users** area.

---

**INFO:** A password, which consists of 5 stars (\*\*\*\*\*), will not be accepted by the system for security reasons.

---

- 6) Enter the new password under **Password** in the **Settings** area.
- 7) Click on **Apply**.
- 8) If you want to reset the password of another user, repeat steps 5 through 7.

### Next steps

Notify the affected user(s) about the new password.

## 11.4 Presence Status (Presence)

The Presence status in the internal directory provides information on the availability of internal subscribers (including Mobility Entry stations). The

Presence status also controls the availability of internal subscribers using status-based call forwarding.

As a subscriber, you can change your Presence status in myPortal Smart, myPortal to go or myPortal for OpenStage. For every change in the presence status (except for **Office**), you can also define the scheduled time of your return to the **Office** status if required.

As a subscriber, you can select the following statuses:

- **Office**
- **Meeting**
- **Sick**
- **Break**
- **Gone Out**
- **Vacation**
- **Lunch**
- **Gone Home**
- **Do Not Disturb** (not available on MULAP configurations)

Using the status-based call forwarding, calls can be forwarded to the personal voicemail box, for example. Subscribers who have no personal voicemail boxes can forward calls to a group mailbox or a system mailbox. However, they have no access to these voicemail boxes via myPortal Smart.

## 11.5 Directories and Journal

Directories and the Journal organize contacts and calls.

### 11.5.1 Directories

Directories are used to organize the contacts of subscribers. Subscribers can access these contacts with UC Smart clients.

The system provides the following directories, which support the following functions and with the below priority for lookup number (lookup number will be supported only for external call and in case that CO/ITSP does not provide the name):

Directory	UC Smart Clients	System telephone with a display
Personal directory	Outlook contacts imported via the Personal Assistant.	
Internal directory	Contains all internal subscribers and groups (with their phone numbers) for which the display has been activated in the system. Internal subscribers with system telephones are shown with presence status. The Presence status of a subscriber can only be shown if allowed by that subscriber.	Contains all internal subscribers and groups for which the display has been activated in the system.
Favorites list	Contains the contacts selected by the subscriber from his or her personal contacts and the internal directory. Internal subscribers with system telephones are shown with their respective presence statuses. The Presence status of a subscriber can only be shown if allowed by that subscriber.	
System Directory	Contains all central speed-dial numbers.	

---

**INFO:** Phone numbers in directories should always be entered in canonical format wherever possible.

---

### 11.5.1.1 How to Configure Directories for System Telephones

#### Prerequisites

- You are logged into the WBM with the **Expert** profile.

You can select which directories are to be made available on system telephones with displays.

#### Step by Step

- In the navigation bar, click on **Expert Mode**.
- Click **Telephony Server > Basic Settings** in the navigation tree.
- In the menu tree, click on **System > Display**.
- Select one of the following options in the **Directory (phone book)** drop-down list:
  - If all the personal contacts, the internal, external and networking directory and the LDAP directory are to be made available, select **All**.
  - If only the personal contacts, the internal, external and networking directory is to be made available, select **Internal**.
  - If only the LDAP directory is to be made available, select **LDAP**.

- If no directory is to be made available, select **No**.

---

**INFO:** The user can activate the search/lookup requests to be handled as requests to the Unified directory, by selecting the **Internal Phonebook via Unified Directory**. When the flag is deactivated and there is no access to Unified Directory, the list view at the phone-book menu, implemented for the OpenScope Desk Phone CP 200/205, is not available.

---

- 5) Click **Apply**.

### **Next steps**

If you have selected **All** or **LDAP**, make sure that an appropriate LDAP directory (e.g., Open Directory Service) is available for the system telephones.

## **11.5.2 Internal Directory**

The internal directory contains the contact details of the internal subscribers and MULAP groups of the communication system. UC Smart clients can access the internal directory.

As an administrator, you have unrestricted access to all data in the internal directory. As a subscriber, you can dial from the internal directory.

The station parameter **Entry in telephone directory** (which can be set in the WBM via the Stations wizard) determines whether or not internal subscribers and groups are displayed in the internal directory.

In an internetwork, the internal directory applies across all nodes.

---

### **Related Topics**

- [Group Call](#)

### **11.5.2.1 How to Enable or Disable the Display of Stations in the Internal Directory**

#### **Prerequisites**

- You are logged into the WBM with the **Expert** profile.

#### **Step by Step**

- 1) In the navigation bar, click on **Expert Mode**.
- 2) In the navigation tree, click **Telephony > Stations**.
- 3) Navigate in the menu tree under **Stations > Station > ...** down to the desired station (Index - Station Number - Name).
- 4) Click on the **Edit Station Flags** tab.



- 5) Select one of the following options:
  - If you want the name of the subscriber to be displayed in the internal directory, enable the check box **Entry in telephone directory**.
  - If you do not want the name of the subscriber to be displayed in the internal directory, clear the **Entry in telephone directory** check box.
- 6) Click on **Apply**, followed by **OK**.

### 11.5.3 Favorites List

The Favorites list contains the contacts selected by the subscriber from the personal contacts and the internal directory. UC Smart clients have access to the Favorites list.

A UC Smart user can call a contact directly from the Favorites list. When an internal subscriber receives a call, the ringing state of the subscriber is displayed. The UC Smart user can then accept this call. In addition, the presence status for internal subscribers is displayed.

### 11.5.4 System Directory

The system directory contains all central speed-dial numbers for which a name was assigned. UC Smart clients can access the system directory.

The administrator individually disable the display for every subscriber and every speed-dial number with a name.

### 11.5.5 Unified Directory

OpenScape Business provides different data sources to store and to retrieve user or contact related data, starting with the internal user data in the internal user configuration, via the internal speed dial list, up to the different directories of the UC applications.

Each data source within OpenScape Business is used by a specific client application either located within the system SW itself in the phone devices or within a UC client application. Depending on the used data sources and the used clients, the retrieved data and their presentation is different.

The "Unified Directory" service within OpenScape Business comprises the existing OpenScape Business data sources for common search and name resolution functions. It provides the same search result or name resolution information to all system devices and OpenScape Business clients.

The Unified Directory service can either be accessed via the Web Service Interface (WSI) from externally located clients like myPortal to go or internally via

the call processing mechanisms (e.g. from OpenStage

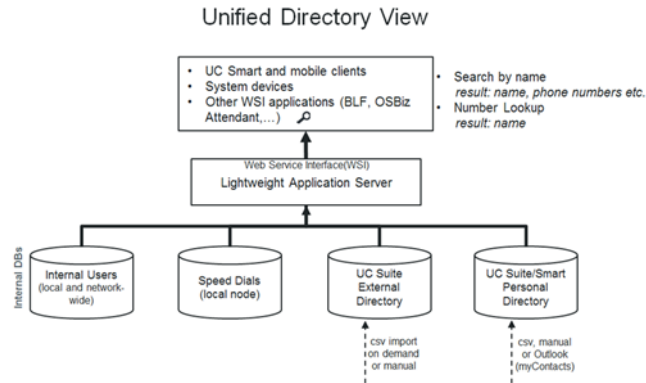

Phones).

Unified Directory uses following internal databases and directories of OpenScape Business:

- Internal user directory (network wide)
- Speed dial lists
- UC Smart Personal Directory (optional)
- UC Suite External Directory (optional)
- Personal Outlook Contacts (if imported via myContacts)

The Unified Directory service is available within every OpenScape Business system from V2R2 on. It does not require specific HW-SW or license prerequisites.

In order to get best results when using the Unified Directory some rules regarding phone number formats and writing of names have to be followed.

### 11.5.5.1 Features

Unified Directory Service provides:###P###

- Directory Search in several internal data sources of OpenScape Business
- Unified offering of the search result to all supported clients
- Phone number Look-Up / Name Resolution in several internal data sources
- Unified offering of name resolution results for all supported clients
- External data access via the WebServices Interface (WSI)

The features are available for single node systems as described in the following. Within OpenScape Business networks, the availability of the features depends mainly on the kind of connection of the trunks, devices and clients within the network.

#### Supported Devices / Clients

Unified Directory supports following clients / system devices of Unify using the indicated interfaces:

Device/Client	Used Interface/Protocol	Remarks
OpenStage phones	Call Processing / HFA protocol	WSI / HTTP(S) is optional on OpenStage 60/80 for caller images
OpenScape Deskphone IP	Call Processing / HFA protocol	WSI / HTTP(S) is optional on DeskPhone IP 55 for caller images
Cordless (CMI) devices	Call Processing / CMI protocol	
CP200	Call Processing / HFA protocol	
DeskPhone CP400/CP600	WSI / HTTP(S)	
myPortal Smart	WSI / HTTP(S)	
myPortal to go	WSI / HTTPS	
Openscape Business Attendant/BLF	Call Processing / CorNet protocol	WSI / HTTP(S) is optional

---

**INFO:** The UC Suite myPortal, myAttendant and myAgent clients use their own mechanisms for directory search and name resolution.

---

### Search function

The Unified Directory search is always performed by using the specific device / client user interface. The search criterions and the used character set could be restricted, depending on the used clients.

After the search criterion is entered the search is performed within subsequent directories

- Internal user directory (network wide)
- Speed dial lists
- UC Smart Personal Directory (optional)
- UC Suite External Directory (optional)
- Personal Outlook Contacts (if imported via myContacts)

All matches within the directories above are shown as search results together with their origin. The matches contain either the full contact data set or only parts of it. The information depth of the results depends on the data source.

The matches are presented at the devices or clients depending on display capabilities.

	Internal UserDirector y	SpeedDials	UC SmartPerso nalDirectory	UC SuiteExterna IDirectory	PersonalOut lookContact s (viamyConta cts)
Last Name	X	---	X	X	X
First Name	X	---	X	X	X
Short/ Displayname	X	X	---	---	---
Office Phone No.	---	---	X	X	X
Home/Ext. PhoneNo.	---	---	X	---	X
Mobile Phone No.	---	---	X	X	X
XMPPID	---	---	---	X	---
Email-Adr.	---	---	X	X	X
Company name	---	---	X	X	X
City	---	---	---	---	---
Contact Picture	---	---	X	---	X
Contact Pictureprevie w	---	---	X	---	X

### Phone Number Look-Up

Unified Directory Phone number Look-Up resolves the transferred calling party (CLI) by a number search in all supported internal data sources . The search is performed within following phone number fields:

- Office number
- Mobile number
- Home number

The Phone number Look-Up is triggered in case of incoming or outgoing calls in general, whereas specific routing and forwarding features are considered in addition.

A fixed prioritization of the data sources that are used for Phone number Look-Up is implemented in order to get the result as fast as possible. The result contains either only lastname, firstname, displayname or ,if available, the full related contact data.

**Table:** Supported Data Sources and Prioritization

Priority	Data Sources	Remark
1	CO/ITSP name (as sent by provider)	Prerequisite is to enable flag "Name in CO".
2	Speed dial list	
3	Personal Contacts	
4	UC User detail	

The retrieved data are presented on the user's device and/or in the UC client. The information depth depends on the display capabilities.

- **Incoming calls**

Supported scenario for single node systems:

- Basic call
- Group call/ MULAP call
- Ringing Group
- Single Step Call Transfer (SSCT)
- Attended/Supervised/Consultation Transfer
- Call Forwarding Unconditional (CFU)
- Call Forwarding No Reply (CFNR)
- Call Forwarding Busy (CFB)
- Blind transfer
- Call Pickup

Supported scenario for multi node (network) scenarios is a Gateway Call.

- **Outgoing call**

In case of an Outgoing Call the Phone number Look-Up of the called party number happens only once.

Supported scenario for single node systems is a Basic Call to external number.

The presentation of the Phone number Look-Up result depends on display capabilities of the phones.

## 11.5.5.2 Rules and Conventions

Some conventions regarding number and name formats within the data sources have to be observed in order to get optimal results using the Unified Directory service.

### Supported Number Format

All external phone numbers within the data sources must be entered in the canonical format including country and area code. e.g.+4989700712345

---

**INFO:** Speed Dial list supports only system dialable format e.g. 0089700712345 or 0004989700712345

---

### Supported Name Formats

The following conventions regarding name formats and character sets have to be observed:

- **Speed dial name format**  
Name search within the Speed Dial List is supported only with specific configuration rules. The first and last names have to be entered within the existing name field using the following pattern:  
<Last Name>, <First Name> (comma separated)
- **Internal Users in case of Migrations**  
Migration to V2R1 and onwards with internal users that do not follow these configuration rules will not be supported in the expected way. This means the administrator should convert internal names to the following pattern before migration:  
<Last Name>, <First Name> (comma separated)

### Availability of directory changes

After creating, updating or deleting contacts in the various data sources it can take up to 10 minutes until all changes appear on Phone number Look-Up results.

## 11.5.5.3 Functional Boundaries

The following functional boundaries do exist regarding Unified Directories:

### Name Search

- Group name support  
Group names (not MULAP names) can currently not be searched in all kind of configurations
- Support of special characters  
On most phone devices the user can only search for standard characters "a-z". Special (diacritical) characters like German characters Ää, Öö, Üü, ß are not accessible via phone device user interface. Therefore special characters are not supported in search filter.  
Names including special characters cannot be searched via the Unified Directory.
- Support of Speed Dial Name format  
Name search within the Speed Dial List is supported only with specific configuration rules. The first- and last names have to be entered within the existing name field using one of the following patterns
  - <Last Name>, <First Name> (comma separated )
  - <First Name> <Last Name> (space separator on this case)

### Name Presentation

Personal Contacts in UC Smart and from external offline directory, with length of first name plus length of last name greater than 24 characters, will be truncated to 24 characters length to fit the display length of the devices.

### Phone number Look-up

The Phone number Look-Up feature (retrieve contact name from calling party number) is not supported in Unified Directory for SIP and S0 devices.

## 11.5.5.4 Unified Directory in Networked Systems

The Unified Directory Service is active within every node of an OpenScape Business Network and uses the datasources of the own system. Phone Devices and Client use always the Unified Directory Service within their own node.

Therefore it depends on the kind of datasource content if netwide contacts are available.

**Table:** Local and Netwide Datasource

Data source	Local data	Netwide data
Internal user directory	X	X
Speed dial lists	X	---
UC Smart Personal Directory	X	---
UC Smart Personal Directory	X	---
Personal Outlook Contacts (via myContacts)	X	---

### Phone number Look-up

In Networking scenarios the Phone number Look-Up functionality is not used. In such scenarios the name is transported via normal networking mechanisms between the network nodes.

For internal users the configured Display Name is used so Lookup is not required.

## 11.5.6 Journal

The journal is the list of all incoming and outgoing calls of a subscriber. It enables subscribers to quickly and easily respond to missed calls and call back their contacts or call them again directly from within the journal.

A maximum of the last 100 calls are displayed to UC Smart users.

### Folder for Call Types

The calls can be arranged in the following groups:

- **Open**
- **Missed**
- **Accepted**
- **All Calls**

### Call Details

Every call is shown with the Date and Time and, if available, with the call number. If a directory contains further details on the call number such as the **Last Name** and **First Name**, then this information is also shown. In addition, the **direction** and **duration** of the calls are displayed, as well as any redirections and call pickups that may have occurred.

## 11.6 Calls

For calls, the call number format is of particular importance.

### 11.6.1 Call Number Formats

Call numbers can be specified in different formats.

Format	Description	Example
Canonical	Begins with + and always includes the country code, area code and the full remaining station number. Blanks and the special characters + ( ) / - : ; are allowed.	+49 (89) 7007-98765
Dialable	Exactly as you would dial the call number on the system telephone in your office, always with the trunk access code.	<ul style="list-style-type: none"><li>• 321 (internal)</li><li>• 0700798765 (own local network)</li><li>• 0089700798765 (external local network)</li><li>• 0004989700798765 (international)</li></ul>

---

**INFO:** If possible, you should always use the canonical call number format. This ensures that a phone number is always complete, unique and consistent for networking and mobile stations in every situation.

---

When dialing an external station (dialable format) manually, the CO access code must always be dialed as well.



When dialing an external phone number in dialable format from a directory (and when using the Desktop Dialer and Clipboard Dialer for certain UC clients), the communication system automatically adds the CO access code (route 1).

---

**INFO:** For calls within the USA via CSTA to a number in canonical format, phone numbers are converted to the dialable format.

---

## 11.7 Conferences

In a conference, multiple participants (including external parties) can communicate with one another at the same time. The Conference Management function enables you to quickly and easily host conferences and also to schedule them in advance.

### Phone-controlled and Application-controlled Conferences

As a subscriber, you can initiate conferences both via the phone and via the myPortal Smart application.

You can initiate a phone-controlled conference in the following ways, and then control that conference via the phone:

- Call the desired conference participant and connect him or her to the conference
- Extend a consultation call into a conference
- Extend a second call into a conference

You can initiate, control and manage application-controlled conferences via the Conference Management of myPortal Smart. A Conference license is required for the use of Conference Management.

Differences between the conference types:

	Phone-controlled conference	Application-controlled conference
Direction of connection setup from the viewpoint of the system	• Outbound	• Inbound (dial-in by the participant)
Authentication of conference participants	-	• Personal PIN (conference ID) • Guest PIN (optional)
Predefined invitation to the conference participants	-	• Conference Name • Dial-in number (MeetMe) • Personal PIN (conference ID) • Guest PIN (optional)
Max. number of participants per conference	8	16

### Scheduled Conference

Scheduled conferences are created as permanent conferences. The conference can be used as needed at any time without further scheduling. Scheduled

conferences do not occupy any conference channel so long as no participant has dialed into the conference. The order of dialing in determines the assignment of the conference channels.

Administrators can change the specified dial-in number (MeetMe) for conferences via the WBM during the initial setup. The dial-in number with which the participants can dial into the conference is shown to the participants. They are then required to authenticate themselves with their personal PIN or with the general guest PIN if allowed.

### Moderators

The initiator of a conference is automatically the moderator and can:

- Create, edit and delete scheduled conferences.
- Add and remove conference participants.  
Removed participants do not remain in the conference.
- Disconnect conference participants.  
Disconnected participants can dial back into the conference.
- Specify another internal participant on the same node as the moderator
- Leave the conference without ending it immediately.  
If the last moderator leaves the conference, it ends after 5 minutes.
- End active conferences.
- Start a web collaboration session in an active conference.
- Send predefined invitations to all or individual conference participants.



All internal participants within a node can be moderators. However, a conference license is required for this.

Conference participants whose contact details were entered manually are treated as external participants and cannot be set as moderators.

### Conference Participants

Conference participants can leave the conference and dial-in again. In addition, they can participate in a web collaboration session has already been started. As long as a conference has only one participant, the participant hears music on hold. The maximum number of external conference participants is limited, inter alia, by the number of available trunks.

Symbol	Status	Description
	Inactive	The participant is not in the conference. No conference channel is used.

Symbol	Status	Description
	Dialing in	The participant is just dialing into the conference.
	Waiting	The participant is in the conference and is currently listening to music on hold.
	Active	The participant is in the conference. A conference channel is in use.

#### Automatic Termination without a Moderator

If the last moderator leaves the conference, the other participants are notified with an info text that the conference will end after about 5 minutes.

#### Notification of Conference Participants

The moderator can send all or some conference participants an invitation by email. This requires an email program to have been installed on the client PC. Known email addresses are automatically added to the distribution list. In an invitation to all conference participants, only the general guest PIN (if allowed) is included; for individual invitations, the personal PIN is also sent.

Alternatively, a predefined invitation text can be copied to the clipboard for further use in other programs (e.g., a chat program).

## 11.8 Web Collaboration

myPortal Smart supports the integration of the separate product Web Collaboration for simultaneous multi-media collaboration during phone calls and conferences. This provides quick access to functions such as desktop and application sharing, file sharing, co-browsing, whiteboarding, URL push, IM chat and video chat with multiple participants.

Web collaboration can be started by a subscriber during a phone call via the Call window of the UC PC client or by the moderator of an active conference from within the conference. A Web page from which the download of the web collaboration client can be initiated is opened. A local installation of Web Collaboration on the UC PC client is not required. If an email program is available on the UC PC client, an email with the link to the web collaboration client can be sent to the communication partners. Detailed information on web collaboration can be found in the Web Collaboration product documentation.

On deleting or ending a conference, the associated web collaboration session is automatically deleted as well.

#### Integration of Web Collaboration

In order to integrate web collaboration, the license number and password for the hosted web collaboration connection must be entered by the administrator in the

WBM. The vendor offers the web collaboration server as a service on the Internet (Public Server). The license number and password are transmitted over a secure https connection. By default, TCP port 5100 is used for this purpose. Local web collaboration servers are not supported.

---

**INFO:** In order to use web collaboration, the UC PC clients and the communication system require an Internet connection. Connections via a proxy are not supported by the communication system.

---

### Instant Messaging and Web Collaboration

Note that Instant Messaging of the system and Instant Messaging of a web collaboration session are mutually independent, i.e., the instant messages from a UC PC client do not appear in a web collaboration session of the same participant, and vice versa.

## 11.8.1 How to Configure the Connection to the Web Collaboration Server (Public Server)

### Prerequisites

- You are logged into the WBM with the **Expert** profile.
- Internet access is available.
- You need a license number and a password for the secure connection to the web collaboration server (public server).

### Step by Step

- 1) In the navigation bar, click on **Expert Mode**.
- 2) In the navigation tree, click on **Applications > Web Services**.
- 3) Navigate in the menu tree down to **Web Services > Web Collaboration**.
- 4) Select the **Public Server** radio button.
- 5) Enter the license number for the secure connection to the web collaboration server (public server) in the **Licence Number** field.
- 6) Enter the password for the secure connection to the web collaboration server (public server) in the **Password** field.

---

**INFO:** If you want to test the Web Collaboration for 5 minutes, you can select the radio button **Public Server (Demo Mode/ Evaluation Mode)**. No license number and password are required for this purpose.

---

- 7) Click on **Apply** followed by **OK**.

## 11.8.2 How to Disable the Connection to the Web Collaboration Server

### *Prerequisites*

- You are logged into the WBM with the **Expert** profile.

### *Step by Step*

- 1) In the navigation bar, click on **Expert Mode**.
- 2) In the navigation tree, click on **Applications > Web Services**.
- 3) Navigate in the menu tree down to **Web Services > Web Collaboration**.
- 4) Select the radio button **No Web Collaboration Server**.
- 5) Click on **Apply** followed by **OK**. The option to start a web collaboration session is disabled in the UC client.

## 11.9 Instant Messaging

Instant Messaging refers to communicating with instant messages (usually called a chat).

### 11.9.1 Instant Messaging

Using instant messaging, you can chat with other users of UC Smart.

The sent and received instant messages are presented to the communication partners as an interactive dialog. On selecting a recipient, the client shows whether the communication partner is currently online. If a communication partner is offline, no instant message can be transmitted to him or her. The IM overview page displays the most recent streams. The system stores a limited number of instant messages. A maximum of up to 100 of the last instant messages of a user are displayed.

### 11.10 Voicemail Box (SmartVM)

The voicemail box (also called SmartVM) plays a greeting to callers and offers them the option of recording a message or being routed to another number. Internal subscribers can access the voicemail box via a telephone and with the UC Smart client myPortal Smart. Subscribers who want to use a voicemail box require a voicemail license.

#### **Voicemail Box Types**

The following different voicemail box types exist:

- **Standard voicemail box:**  
The standard voicemail box is the personal voicemail box of a subscriber. It accepts the call, greets the caller with a personal or standard announcement and offers the caller the option to leave a message. The standard voicemail box can be configured by the subscriber (by recording a personal greeting, for example) via the telephone or via myPortal Smart.
- **Group voicemail box:**  
The group voicemail box has the same features as the standard voicemail box, except that it is not assigned to a single user, but a group of users. Messages can be recorded for a group voicemail box only if at least one member of the group has a voicemail license. The info of the voicemail box is displayed to all group members with a voicemail license. Message playback is possible through the phone menu of the personal voicemail box of the group members.
- **Attendant voicemail boxes (AutoAttendant / Company AutoAttendant):**  
The Attendant voicemail box offers callers a greeting with or without subsequent routing options. A special form of the AutoAttendant voicemail box is the Company AutoAttendant. Here, the caller can be optionally forwarded automatically (to the switchboard, for example) or selectively to another station (e.g., to the service or hotline) by dialing an internal call number or speed dial number (digits 0-9). These dialing options must, of course, be explained with a corresponding announcement. It is also possible to configure an intercept destination to which the caller will be redirected if he or she fails to enter a digit or enters an invalid (i.e., unassigned) digit. The administrator can configure up to 100 Attendant voicemail boxes.
- **Announcement voicemail box:**  
The announcement function is configured by assigning an announcement index to an announcement port and configuring a voicemail box with the call number of the announcement port. The greeting of the mailbox is used as the announcement. Depending on the type of announcement, the playback may occur once (outgoing message) or cyclically (music). The phone menu of an announcement voicemail box can only be used from a different phone, since there is no associated phone. Consequently, a different PIN must be used for the announcement voicemail box than for the voicemail box of the used telephone.
- **System voicemail box:**  
The voicemail box with the call number of the hunt group of the SmartVM is used as a system voicemail box. The system voicemail box must be a standard voicemail box (not an AutoAttendant) with voice recording enabled. The info of the voicemail box is displayed to the owner of the voicemail box with index 1 and can also be checked from there. This first voicemail box should not be a Group, Attendant or Announcement voicemail box. If the system voicemail box is not to be used, then no voicemail box should be configured with the call number of the SmartVM hunt group.

### **Features of the Voicemail Box**

- Checking and control via a telephone  
(from external location: own telephone number required)
- Manual or automatic selection of different greetings

- Phone menu (Telephone User Interface, TUI) with a system-wide switchable menu structure:
  - Phone menu, UC Smart: **SmartVM** (similar to Xpressions Compact / EVM)
  - Phone menu, UC Suite: **OSO** (similar to UC Suite)
- Up to 320 voicemail boxes can be set up per system
- Up to 32 hours of voice recording capacity per system
- Up to 100 stored messages per voicemail box
- Up to 2 minutes of recording time for a voicemail per voicemail box
- Up to 10 simultaneously possible switching and call answering operations
- Announcement/music before answering
- Playback of individual announcements
- Forwarding of fax calls through automatic fax tone recognition to a preconfigured fax destination

---

**INFO:** Details on the phone menu can be found in the two Quick Reference Guides, UC Smart Telephone User Interface (TUI) and UC Suite Telephone User Interface (TUI).

---

### Code Number Settings

Before the first use of the voicemail box, every subscriber must change the preassigned code number (default: 123456).

The code number consists of a six digit sequence. Repeated digits (e.g., 333333) and digit sequences in ascending or descending order (e.g., 987654) are not allowed. After an invalid code number has been entered six times, access to the corresponding voicemail box is locked until the password is reset by the administrator. After two incorrect entries of the password via the phone menu, the connection is dropped.

### Ports

The voicemail box uses the S<sub>0</sub> ports 500 to 509, which are assigned the call numbers 739 to 748, respectively. The ports 504 and 505 are assigned by default to the Company AutoAttendant (call number 352), and the remaining 8 ports are assigned to the voicemail box of the hunt group (call number 351). The call number 351 is the general call number of the voicemail box via which the phone menu is accessible.

### Toll restriction

For security reasons, the ports of the voicemail box only have outward-restricted trunk access by default. The following features require the assignment of a COS group with direct trunk access:

- Call sender of a voice message
- Mobility users can listen to voice messages via callback
- Messages are transferred to an external destination using the Company AutoAttendant

### Greetings / Announcements

Custom greetings (= announcements) can be either recorded from a phone or loaded into the system with the WBM. The configuration of a custom greeting via the phone occurs by dialing the voicemail box number and then using the user prompts of the voicemail box to record a new greeting over the phone.

Greetings can, however, also be loaded into the system separately for each voicemail box and subsequently saved or deleted in Expert mode.

---

**INFO:** For voicemail playback via external phone numbers (e.g. playback via mobile phone triggered by myPortal to go or myPortal Smart), the class-of-service of the Smart VM ports has to be adjusted. It is recommended to use an "allowed list" for such well-known numbers.

---

## 11.10.1 Configuring the Voicemail Box (SmartVM)

Configuring the voicemail box (SmartVM) includes the configuration of standard/group voicemail boxes and the Attendant voicemail boxes.

The general settings for the voicemail box (SmartVM) such as the adaptation of the voicemail box call number to a 4-digit dial plan, for example, are made via the **SmartVM** wizard.

The special settings for the voicemail box (SmartVM) and the setup of standard/group voicemail boxes and Attendant voicemail boxes are performed in Expert mode.

---

**INFO:** Changing a call number resets the voicemail box of the corresponding subscriber. All personal voice messages, greetings and announcements are lost, and the password is reset.

---

You can also load individual greetings into the SmartVM, save and delete them, as well as back up and restore the greetings and messages of individual or all voicemail boxes. In addition you can check the loaded languages of the user prompts and display the 10 voicemail boxes with the most messages as well as the amount of storage space used by the messages and greetings.

The setup of Attendant voicemail boxes can be found in the section Attendants - AutoAttendants - Company AutoAttendant (UC Smart).

### Assigning the Mailbox to Subscribers

Once the voicemail box (SmartVM) has been configured, the subscribers can be assigned their default mailboxes. This is possible through

- call forwarding for the subscriber with the aid of a call destination list (set up by the administrator). In this case, the call is forwarded sequentially to the selected call destinations (e.g., first to the subscriber and then - after a definable time period - to the mailbox).



- Call forwarding set up at the phone of the subscriber (which can be done by the subscribers themselves). In this case, the call goes immediately to the mailbox.  
If the subscriber is a member of a hunt group and the hunt group is called, the call is not redirected to the voicemail box of the hunt group.

### 11.10.1.1 How to Disable or Enable the Voicemail Box

#### *Prerequisites*

- You are logged into the WBM with the **Expert** profile.
- UC Smart has been activated.

#### *Step by Step*

- 1) In the navigation bar, click on **Expert Mode**.
- 2) Click on **Telephony > Auxiliary Equipment** in the navigation tree.
- 3) Click on **Auxiliary Equipment > SmartVM** in the menu tree.
- 4) Click on the **Edit SmartVM Parameters** tab.
- 5) If you want to deactivate the voicemail box, select the **EVM Deactivation** check box.
- 6) If you want to activate the voicemail box, clear the **EVM Deactivation** check box.
- 7) Click on **Apply** followed by **OK**.

### 11.10.1.2 How to Configure the Voicemail Box (SmartVM)

#### *Prerequisites*

- You are logged on to the WBM with the **Advanced** profile.

#### *Step by Step*

- 1) In the navigation bar, click on **Setup**.
- 2) In the navigation tree, click on **Wizards > Central Telephony**.
- 3) Click on **Edit** to start the **SmartVM** wizard.
- 4) Select the **Activate SmartVM** check box.
- 5) If required, change the general settings for the system mailbox under the **Voicemail** column:
  - a) If required, change the call number of the voicemail box in the **Call number** field (default: 351) to adapt it to a 4-digit dial plan, for example.
  - b) If required, change the direct inward dialing number of the voicemail box in the **DID** field (default: 351) to adapt it to a 4-digit dial plan, for example.

- c) If required, change the name of the voicemail box in the **Name** field (default: VOICEMAIL).
- 6) If required, change the general settings for the Attendant mailbox under the **AutoAttendant** column:
  - a) If required, change the call number of the voicemail box in the **Call number** field (default: 352) to adapt it to a 4-digit dial plan, for example.
  - b) If required, change the direct inward dialing number of the voicemail box in the **DID** field (default: 352) to adapt it to a 4-digit dial plan, for example.
  - c) If required, change the name of the AutoAttendant box in the **Name** field (default: AutoAttendant).
- 7) Click on **OK & Next**.
- 8) If required, change the call number of the port in the **Call no** field in the row of the desired port (default: 739-748) to adapt to a 4-digit dial plan, for example.
- 9) If required, change the port name in the row of the desired port in the **Name** field (default: SmartVM 1-10).
- 10) If required, change the type of the port in the **Type** drop-down list in the row of the desired port.
  - **Phone mail (Callno. 5 digits)**: The port is assigned to the standard voicemail boxes and the Attendant voicemail boxes of type AutoAttendant. Ports of this type are automatically included in the hunt group 351.
  - **Standard**: The port is assigned to the Attendant voicemail boxes of type Company AutoAttendant and the announcement mailboxes. Ports of this type are automatically included in the hunt group 352.
- 11) If required, change the mode of the port in the **Mode** drop-down list in the row of the desired port.
  - **Announcement**: A greeting/announcement is played once.
  - **Music On Hold**: The greeting/announcement/music is played in a loop.
  - **Company AutoAttendant**: After playing a greeting/announcement, further switching is possible.
- 12) Click on **OK & Next**.
- 13) Select the desired mailbox in the **Mailbox selection** drop-down list. The fields for configuring the greetings will then appear.
- 14) If you want to use your own greetings for the selected mailbox, click on **Browse**, navigate to the storage location of the files (format: wave, PCM, 16 bit, 8 kHz, mono) and click on **Load**. The selected greetings are loaded into the system.

---

**INFO:** Previously loaded greetings can be saved or deleted.

---

- 15) If you want to set up greetings for further mailboxes, repeat steps 13 through 14.
- 16) Click on **OK & Next**.
- 17) You should change the general parameters only if required. For a description of the general parameters, see [Auxiliary Equipment > SmartVM](#).
- 18) Click on **OK & Next** and then on **Finish**.

### 11.10.1.3 How to Add a Standard Voicemail Box for a Subscriber

#### *Prerequisites*

- You are logged into the WBM with the **Expert** profile.
- The corresponding subscriber has been assigned a voicemail license.

#### *Step by Step*

- 1) In the navigation bar, click on **Expert Mode**.
- 2) Click on **Telephony > Auxiliary Equipment** in the navigation tree.
- 3) Click on **Auxiliary Equipment > SmartVM** in the menu tree.
- 4) Click on the **Edit SmartVM Mailboxes** tab.
- 5) In the **Mailbox call no.** field, enter the call number of the subscriber for whom the voicemail box is to be added.
- 6) Select a greeting from the **Greeting** drop-down list.
- 7) If a caller may leave a message in the voicemail box, select the **Recording** check box.
- 8) Make sure that the **AutoAttendant** check box is selected.
- 9) The **Password Reset** check box must be cleared when setting up a new voicemail box. It is used to reset the password of the voicemail box. When a new voicemail box is created, the subscriber must change the initial password anyway when accessing his or her voicemail box for the first time.
- 10) Click on **Apply** followed by **OK**.

### 11.10.1.4 How to Change the COS Group for a Voicemail Box Port

#### *Prerequisites*

- You are logged into the WBM with the **Expert** profile.
- UC Smart has been activated.

### ***Step by Step***

- 1) In the navigation bar, click on **Expert Mode**.
- 2) Click on **Telephony > Classes of Service** in the navigation tree.
- 3) Click in the menu tree on **Classes of Service > Stations > IVM/EVM Ports > EVM** and then on the desired voicemail box port.
- 4) Select the the desired COS groups for the day and night service on the **Edit COS Group** tab from the **Class of Service Group Day** and **Class of Service Group Night** drop-down lists, respectively.
- 5) Click on **Apply**, followed by **OK**.

## **11.10.1.5 How to Change the Structure of the Phone Menu for the Voicemail Box**

### ***Prerequisites***

- You are logged into the WBM with the **Expert** profile.
- UC Smart has been activated.

### ***Step by Step***

- 1) In the navigation bar, click on **Expert Mode**.
- 2) Click on **Telephony > Auxiliary Equipment** in the navigation tree.
- 3) Click on **Auxiliary Equipment > SmartVM** in the menu tree.
- 4) Click on the **Edit SmartVM Parameters** tab.
- 5) If you want the structure of the phone menu to be similar to Xpressions Compact, select the entry **SmartVM** in the **Telephone User Interface** drop-down list.
- 6) If you want the structure of the phone menu to be similar to OpenScope Office, select the entry **OSO** in the **Telephone User Interface** drop-down list.
- 7) Click on **Apply** followed by **OK**.

## **11.10.1.6 How to Load, Save and Delete Individual Greetings**

### ***Prerequisites***

- You are logged into the WBM with the **Expert** profile.
- UC Smart has been activated.

### ***Step by Step***

- 1) In the navigation bar, click on **Expert Mode**.
- 2) Click **Maintenance > Configuration** in the navigation tree.

- 3) Click in the menu tree on **Configuration > SmartVM Configuration > File Operations**.
- 4) Click on the **Greetings** tab.
- 5) Select the desired voicemail box from the **Mailbox selection** drop-down list.
- 6) If you want to load a previously saved greeting or a wave file into the SmartVM, click at the desired greeting on **Browse** and navigate to the storage location of the greeting. Then click **Load**.

---

**INFO:** The wave file to be loaded must have the following format: PCM, 8 kHz, 16 bit, mono. The wave file is converted on loading. Depending on the size of the wave file, this may take some time to complete.

---

- 7) If you want to save an existing greeting, click at the desired greeting on **Save** and save the vma file to a location of your choice.
- 8) If you want to delete an existing greeting, click at the desired greeting on **Delete** and confirm this with **OK**.

### 11.10.1.7 How to Back up and Restore Greetings and Messages

#### *Prerequisites*

- You are logged into the WBM with the **Expert** profile.
- UC Smart has been activated.

#### *Step by Step*

- 1) In the navigation bar, click on **Expert Mode**.
- 2) Click **Maintenance > Configuration** in the navigation tree.
- 3) Click in the menu tree on **Configuration > SmartVM Configuration > File Operations**.
- 4) If you want to back up greetings and messages:
  - a) Click on the **Backup** tab.
  - b) Select the **Messages** check box if the messages are to be backed up in addition to the greetings.
  - c) Transfer the voicemail boxes to be backed up from the **Available Mailboxes** list to the **Mailboxes for backup** list.
  - d) Click on **Apply**. The greetings (and messages if the **Messages** flag was enabled) of the voicemail boxes to be backed up are saved in a backup file (\*.tar). Save the file to a location of your choice.
- 5) If you want to restore greetings and messages:
  - a) Click on the **Restore** tab.

- b) Click on **Browse**, navigate to the storage location of your backup file (\*.tar) and click on **Open**.
- c) Click on **Load** followed by **OK**. The voicemail boxes contained in the backup file are displayed.
- d) Transfer the voicemail boxes to be restored from the **Available Mailboxes** list to the **Mailboxes for restore** list.
- e) Select the **Messages** check box if not only the greetings of the selected voicemail boxes, but also the messages are to be restored.
- f) If the **Override** check box is cleared, only the greetings of the selected voicemail boxes that are present in the backup data will be overwritten. If the **Messages** check box is also selected, the messages contained in the backup data are included as well. The existing messages are retained
- g) If the **Override** check box is selected, all the greetings and messages of the selected voicemail boxes in the SmartVM will be deleted before the restore. If voicemail boxes which are not contained in the backup data are selected, these will also be deleted! The greetings contained in the backup data are transferred. If the **Messages** check box is also selected, the messages contained in the backup data are transferred as well.
- h) Click on **Load** followed by **OK**. The greetings and messages of the selected voicemail boxes are restored.

## 11.10.2 Notification Service for Messages

The system can optionally notify a UC Smart user about a new voicemail by e-mail.

### Prerequisites for the Notification Service

- The delivery of e-mails (e-mail forwarding) has been configured by the administrator in the system.
- The user's e-mail address must be known to the system. The administrator can import all e-mail addresses in the WBM during the initial installation via an XML file or enter an e-mail address for each user in the UC Smart Assistant (see [How to Configure UC Smart Users](#)). Alternatively, users can specify their own e-mail addresses in their UC Smart client.
- A Voicemail licence is assigned to the user.
- The Voicemail to e-mail feature is enabled. The administrator can activate the feature for each user in the UC Smart Assistant ([How to Enable or Disable E-mail Notifications](#)). Alternatively, users can activate the feature themselves in their UC Smart client.

The UC Smart user receives an e-mail with the voicemail as an attached WAV file (16 bit, mono), together with the date and time of receipt, duration of the voicemail and, if available, the phone number and name of the sender.

## 11.10.2.1 How to Enable or Disable E-mail Notifications

### *Prerequisites*

- You are logged on to the WBM with the **Advanced** profile.
- The **Package with UC Smart** has been activated under **Application Selection** in Expert mode.
- The e-mail address of the user is entered in his or her profile details.

### *Step by Step*

- 1) In the navigation bar, click on **Setup**.
- 2) In the navigation tree, click on **Wizards > UC Smart**.
- 3) Click on **Edit** to start the **UC Smart** wizard.
- 4) Click on **Administration > User Management** in the menu tree.
- 5) Select the desired user in the **Users** list.
- 6) Select one of the following options:
  - a) If you want to enable the notification service for new messages, select the **Voicemail to e-mail** check box in the **profile details** area.
  - b) If you want to enable the notification service for new messages, clear the **Voicemail to e-mail** check box in the **profile details** area.
- 7) Click **Apply**.
- 8) If you want to configure another user, repeat steps 5 through 7.

## 12 UC Suite

The UC Suite provides unified communications features such as the Presence status and CallMe, conferencing, as well as voicemail and fax functionality in the myPortal for Desktop and myPortal for Outlook clients. myAttendant also provides Attendant Console functions.

---

**INFO:** For the OpenScape Business hardware models X3/X5/X8, the UC solution UC Suite requires the UC Booster hardware (UC Booster Card or UC Booster Server). With OpenScape Business S (softswitch), the UC solution UC Suite is already integrated.

---

---

**INFO:** After changes in configuration of Stations, Groups, Mobility or other system parameters like trunk access codes, the UC Data for either UC Smart or UC Suite need to be synchronized. Synchronization occurs five minutes after the last configuration change. If a later configuration change occurs before the 5 minutes timer, the timer is restarted. UC Data may outdated until synchronization starts. During the synchronization the UC Application and the Web Services Interface API are not available and any connected UC clients lose their connection until UC Data synchronization is finished. Connections are restored automatically after UC Data Synchronization is finished.

---

### 12.1 Basic Settings for UC Suite

The basic settings for UC Suite can be customized.

UC Suite can be enabled or disabled. If UC Suite is used, UC Smart must be disabled.

In addition, for all UC calls initiated by the system (e.g., via the Call-Me service), a check can be performed before dialing to determine whether the requesting UC user has the requisite class of service for that call. If the UC user does not have the required class of service, the call is not executed.

---

#### Related Topics

- [How to Determine the IP Addresses of the System Components](#)



## 12.1.1 How to Activate UC Suite

### *Prerequisites*

- You are logged into the WBM with the **Expert** profile.

### *Step by Step*

- 1) In the navigation bar, click on **Expert Mode**.
- 2) Click in the navigation tree on **Applications > Web Services**.
- 3) In the menu tree, click on **Application Selection > Application Selection**.
- 4) Select one of the following options:
  - If you want to use the UC Suite with the UC Booster Card, click on **Package with UC Suite**.
  - If want to use the UC Suite with the UC Booster Server, click on **Package with UC Suite on OSBiz UC Booster Server** and, in addition, enter the IP address of the external Linux server in the **IP address of the OSBiz UC Booster Server** field.
- 5) Click on **Apply**.

## 12.1.2 How to Restrict the Authorization for UC Calls Initiated by the System

### *Prerequisites*

- You are logged into the WBM with the **Expert** profile.

### *Step by Step*

- 1) In the navigation bar, click on **Expert Mode**.
- 2) Click in the navigation tree on **Telephony Server > Basic Settings**.
- 3) In the menu tree, click **Basic Settings > System > System Flags**.
- 4) If an authorization check before dialing is to be performed for system-initiated UC calls to verify whether the requesting UC Suite user has the required class of service for that call, select the **Restriction for UC calls** check box in the **Restriction for UC calls** area.
- 5) If no authorization check before dialing is to be performed for system-initiated UC calls to verify whether the requesting UC Suite user has the required class of service for that call, clear the **Restriction for UC calls** check box in the **Restriction for UC calls** area.
- 6) Click on **Apply**.

## 12.2 UC Suite Clients

UC Suite clients provide subscribers with convenient user interfaces for comprehensive unified communications functions.

The system offers the following UC Suite clients for the following devices:

Client type	Client	Device
Communications Client	myPortal for Desktop	PC
	myPortal for Outlook	
	Fax Printer	
	myAttendant	
	myPortal for OpenStage (UC Suite)	OpenStage telephone
Mobile Client	myPortal to go (UC Suite) (see <a href="#">Mobility</a> )	Smartphone, Tablet PC
Contact Center Client	myAgent (see <a href="#">Multimedia Contact Center</a> )	PC
	myReports (see <a href="#">Multimedia Contact Center</a> )	

Subscribers with a configured e-mail address receive a welcome e-mail with Getting Started instructions.

### Custom Settings

The custom (i.e., subscriber-specific) settings for myPortal for Desktop are stored in ini files on the PC. A separate ini file is created for every user. The custom settings for myPortal for Outlook, myAttendant and Fax Printer are stored in the registry of the PC. This enables different users to use the myPortal for Desktop, myPortal for Outlook, myAttendant and Fax Printer applications on a single PC (Desk Sharing) and also the deployment in Windows Terminal Server and Citrix Server environments. This allows different users to access the applications from their PCs without a local installation.

### 12.2.1 myPortal for Desktop

myPortal for Desktop is a client for unified communications on your PC. Besides convenient dialing aids via phone directories and favorites and information on the presence status of other subscribers, users can, for example, also access their voicemails and fax messages.

myPortal for Desktop provides the following features:

- Directories
- Favorites List
- Journal

- Desktop Dialer
- Screen Pops
- Presence status
- CallMe service with ONS (One Number Service)
- Status-based call forwarding
- Personal AutoAttendant
- Conference management
- Recording conferences
- Record calls
- Instant Messaging
- Voice and fax messages

### 12.2.1.1 How to Customize an an Alternative Modern User Interface for myPortal for Desktop

#### *Prerequisites*

- You are logged on to the WBM with the **Advanced** profile.

You can customize the appearance of the alternative modern user interface for myPortal for Desktop by performing the following steps:

#### *Step by Step*

- 1) In the navigation bar, click on **Setup**.
- 2) Click in the navigation tree on **Wizards > UC Suite**.
- 3) Click on **Edit** to start the **Skin Settings** wizard.
- 4) Click on **Browse** and select the desired file.
- 5) Click on **Upload**.
- 6) Select one of the following options for the font color to be used:
  - If you want to use the white font, select the **Use white font** check box.
  - If you want to use the black font, select the **Use black font** check box.

### 12.2.1.2 How to Delete the Alternative Modern User Interface for myPortal for Desktop

#### *Prerequisites*

- You are logged on to the WBM with the **Advanced** profile.

#### *Step by Step*

- 1) In the navigation bar, click on **Setup**.
- 2) Click in the navigation tree on **Wizards > UC Suite**.

- 3) Click on **Edit** to start the **Skin Settings** wizard.
- 4) Click on **Delete**.

## 12.2.2 myPortal for Outlook

myPortal for Outlook is the client for unified communications in Microsoft Outlook (plug-in) and is analogous to myPortal for Desktop.

myPortal for Outlook provides the following features in addition to those of myPortal for Desktop:

- How to Call an Outlook Contact
- How to Create an Outlook Contact from the Sender of a Voice Message
- How to Send a Voice Message as an E-mail
- How to Send a Fax Message as an E-mail

## 12.2.3 Fax Printer

Fax Printer is a Windows application for sending fax messages with individually created cover sheets from other Windows applications such as Microsoft Word, for example.

Fax Printer consists of the following components:

- Fax Printer Cover Editor
- Fax Printer Driver - with the following features:
  - Sending faxes to individual recipients
  - Directories
  - Use of central cover sheets
  - Using predefined headers
  - Merge fax
  - Control via the user interface
  - Control via the command line

## 12.2.4 myAttendant

myAttendant is a unified communications solution for Attendant functions. Besides convenient Attendant functions, dialing aids via phone directories and information on the presence status of other subscribers, myAttendant can, for example, also be used to access voicemails and faxes. Instant Messaging supports the communication with internal subscribers.

myAttendant provides the following features:

- Attendant functions
- Directories

- Journal
- Pop-up windows
- Change the presence status of subscribers
- Record calls
- Message Center
- User Buttons
- Manage voice and fax messages
- Instant Messaging
- Team functions
- Conference management

## 12.2.5 myPortal for OpenStage

myPortal for OpenStage is the user portal for accessing unified communications functions of the system on your system telephone.

The configuration of myPortal for OpenStage is possible directly on the system telephone via the administrator settings or via the WBM of the system telephone.

myPortal for OpenStage provides the following features:

- Presence status
- Voicemail

## 12.2.6 Prerequisites for UC Suite PC Clients

In order to use UC Suite PC clients, the client PC must be equipped with the appropriate hardware and software configurations. Depending on the configuration, administrator rights are required for the installation and automatic updates. The available functionality depends on the licenses being used.

---

**INFO:** Please make sure that you refer to the current notes in the `ReadMe first` file, which is located in the storage directory of the install files.

---

### Telephones

The UC clients can be used in combination with the following telephones:

- OpenStage HFA and SIP
- OpenScape Desk Phone IP 35G/55G HFA and SIP
- OpenScape Desk Phone IP 35G Eco HFA and SIP
- OpenScape Desk Phone CP 200/205/400/600 HFA and SIP
- SIP phones with 3PCC support
- Analog telephones

- ISDN Phones
- OpenScape Personal Edition HFA and SIP
- OpenStage S5/M3/SL4 (OpenScape Business Cordless)
- optiPoint WL3 professional SIP

Older devices (such as optiPoint 410/420/500, Gigaset M2/SL3/S4 and optiPoint WL2 SIP) are supported. Optiset E devices cannot be operated. For details on the tested and released devices, please refer to the Release Notice.

---

**INFO:** OpenScape Desk Phone CP 400/600 HFA integrated Client does not have any special prerequisites, apart from the standard client configuration and license.

"Favorites" in phone menu contains Free Programmable Keys and does not relate to UC Favorites. Details for those keys and how to, are available within the device documentation.

---

---

**INFO:** For analog and DECT telephones, the Message Waiting Indication (MWI) is not supported, and only limited support is available for displaying information on the phone.

---

## Operating Systems

The UC Suite PC clients can be used in conjunction with the following operating systems:

- Apple Mac OS X 10.10 / 10.9 / 10.8 / 10.7
- Microsoft Windows 10 / 8.1 / 8 / 7 (both 32-bit or 64-bit are possible)
- Microsoft Windows Vista (32 bit)
- Office 365 (local installation = Office 2013)

---

**INFO:** The used operating system always requires the latest version of all available updates (Service Packs and patches).

---

Support for the UC Suite PC clients for Microsoft Office 2003, Microsoft Windows XP and Microsoft Windows Server 2003 will end at the same time as the end of support for these products by Microsoft. The product will still be supported, but will no longer be tested in detail.

Local administrator rights on a client PC are required for the installation under Windows, but not for automatic updates. The Russian and Chinese user interfaces of myPortal for Outlook require a corresponding Russian or Chinese Windows installation.

myPortal for desktop for Apple MAC is available with same interface as under Microsoft Windows. However, due to the Apple MAC OS system architecture, the following functions are currently not supported:

- Sending faxes
- Outlook, Entourage Integration

myPortal for Outlook is supported in Microsoft Office 365 environments. Microsoft Office 365 is a cloud application It includes, among other things, an Exchange server for the centralized distribution of e-mails as well as the traditional Microsoft Office products. OpenScope Business supports Microsoft Office 365.

The following functions can be used under Microsoft Office 365:

- Exchange Calendar Integration
- E-Mail Forwarding

### Web Browsers

The following web browsers have been released for programming telephone keys via the UC clients:

- Microsoft Internet Explorer Version 10 (or later)
- Mozilla Firefox Version 19 (or later)
- Google Chrome

### Additional Software

Additional Software	myPortal for Desktop	myAttendant	myPortal for Outlook
Oracle Java: latest version (32 bit / 64 bit)	X	X	
Microsoft Office 16, including Outlook (32 bit / 64 bit) or Microsoft Office 2013 / 2010 (32 bit / 64 bit) or Microsoft Office 2007 (32 bit) or Microsoft Office 365			X
Access to Microsoft Exchange Server (for Outlook contacts and appointments) Exchange 2015 / 2013 / 2010 (64 Bit) Exchange 2007 (32 bit)	X		X
Microsoft .NET Framework >= 3.5 (as of Outlook 2007) or Microsoft .NET Framework >= 4.0 (as of Outlook 2010)			X

---

**INFO:** In order to use the Exchange Calendar integration with Microsoft Small Business Server, FBA (Form Based Authentication) may need to be disabled there under some circumstances.

---

### Note about Oracle Java 32 bit or 64 bit

In order to use the myPortal for Desktop function "Import Outlook Contacts at Startup" in conjunction with the 64-bit version of Microsoft Office 2013, an installation of the 64-bit variant of Oracle Java is required. If this function is not used, the Oracle Java 32 bit version is recommended, since the memory

requirements for it are significantly lower. For this reason, the 32-bit version of Oracle Java is generally recommended for all other installations as well.

### Minimum Hardware Requirements

- 2 GHz CPU
- RAM: 2 GB
- 100 Mbps LAN (1 Gbps LAN recommended)
- XGA (1024x768) screen resolution, myPortal for Outlook: SVGA (800x600) screen resolution

---

**INFO:** 4K monitors are not supported for myPortal and myAttendant.

---

### Microsoft Terminal Server, Citrix XenApp Server

The UC Suite PC clients can be used in Microsoft Terminal Server and Citrix Server environments under the following preconditions:

---

**INFO:** Terminal Server and Citrix Server environments, including hosted services and virtual environments are the responsibility of the customer.

---

---

**INFO:** Citrix server environments can decode some regional characters (e.g., German umlauts) correctly.

---

Operating systems:

- Microsoft Windows Server 2015 (32 bit / 64 bit) as Microsoft Terminal Server
- Microsoft Windows Server 2012 (32 bit / 64 bit) as Microsoft Terminal Server
- Microsoft Windows Server 2008 R2 (64 bit) as Microsoft Terminal Server
- Microsoft Windows Server 2008 R2 (64 bit) with Citrix XenApp 6.5 Server (Desktop Mode)

Office applications:

- Microsoft Office 16, including Outlook (32 bit / 64 bit)
- Microsoft Office 2013 (32 bit / 64 bit)
- Microsoft Office 2010 (32 bit / 64 bit)
- Microsoft Office 2007 (32 bit)

Hardware Prerequisites: The number of installable clients depends on the server performance and on the amount of available memory. If the server is also being used for other applications, their memory requirements must also be taken into account.

More information on the configuration of Citrix XenApp Server can be found under:

[http://wiki.unify.com/wiki/OpenScape\\_Business](http://wiki.unify.com/wiki/OpenScape_Business).



### Installation Files

The following options are available for providing installation files to users:

- The administrator downloads the installation files from the **Service Center** and makes them available to users via a network drive, for example.

## 12.2.7 Prerequisites for myPortal for OpenStage

In order to use myPortal for OpenStage, the phone must be equipped with the appropriate hardware and software.

### Telephones

myPortal for OpenStage can be used with the following telephones:

- OpenStage 60/80
- OpenScape Desk Phone IP 55G

### Web Browsers

myPortal for OpenStage can be used in combination with the following web browsers (for configuration and administration):

- Microsoft Internet Explorer Version 10 (or later)
- Mozilla Firefox Version 19 (or later)
- Google Chrome

## 12.2.8 Silent Installation/Uninstallation for UC Suite PC Clients

Silent installation/uninstallation is a command-line based method to automatically install, uninstall or modify UC Suite PC clients on a PC without requiring any further user inputs.

---

**INFO:** Please make sure that you refer to the notes in the `ReadMe first.rtf` file.

---

The silent installation/uninstallation option is available as of V3 and requires local administration rights on the relevant PC. The silent installation/uninstallation process can also be logged in a file.

The following parameters are available for silent installations / uninstalls:

Parameters	Components
ALL	<ul style="list-style-type: none"> <li>• myPortal for Desktop / myAttendant</li> <li>• myPortal for Outlook</li> <li>• Fax Printer</li> <li>• myAgent</li> <li>• Automatic Updates</li> </ul>
myPortal	myPortal for Desktop / myAttendant
OutlookIntegration	myPortal for Outlook
FaxPrinter	Fax Printer
myAgent	myAgent

## 12.2.8.1 How to Perform a Silent Installation

### Prerequisites

- Your PC meets the requirements described under [Prerequisites for UC Suite PC Clients](#).
- You have local administration rights on the client PC.
- The file `CommunicationsClients.exe` is available on the client PC.

---

**INFO:** Please make sure that you refer to the notes in the `ReadMe` first file.

---

Use the command line in accordance with the following patterns in a batch file or in a window with the DOS command prompt.

### Step by Step

- 1) If you do not want to log the process, select one of the following command lines:

---

**INFO:** Note the correct notation for parameters in uppercase and lowercase letters.

---

- If you want to install all components:  
`CommunicationsClients.exe /passive ADDLOCAL=ALL`
- If you want to install multiple components, specify their corresponding parameters as a comma-separated list after `ADDLOCAL=`, e.g., myPortal for Desktop / myAttendant and Fax Printer:  
`CommunicationsClients.exe /passive  
ADDLOCAL=myPortal,FaxPrinter`

- If you want to install only one component, enter the appropriate parameter after ADDLOCAL=, e.g., myPortal for Desktop / myAttendant:  
`CommunicationsClients.exe /passive ADDLOCAL=myPortal`
- 2) If you want to log the process in a file, e.g., in C:\ccinstall.log, select one of the following command lines:

---

**INFO:** Note the correct notation for parameters in uppercase and lowercase letters.

---

- If you want to install all components:  
`CommunicationsClients.exe /passive /L*V  
"C:\ccinstall.log" ADDLOCAL=ALL`
- If you want to install multiple components, specify their corresponding parameters as a comma-separated list after ADDLOCAL=, e.g., myPortal for Desktop / myAttendant and Fax Printer:  
`CommunicationsClients.exe /passive /L*V  
"C:\ccinstall.log" ADDLOCAL=myPortal,FaxPrinter`
- If you want to install only one component, enter the appropriate parameter after ADDLOCAL=, e.g., myPortal for Desktop / myAttendant:  
`CommunicationsClients.exe /passive /L*V  
"C:\ccinstall.log" ADDLOCAL=myPortal`

## 12.2.8.2 How to Perform a Silent Uninstallation

### *Prerequisites*

- Your PC meets the requirements described under [Prerequisites for UC Suite PC Clients](#).
- You have local administration rights on the client PC.
- The file `CommunicationsClients.exe` is available on the client PC.

---

**INFO:** Please make sure that you refer to the notes in the `ReadMe` first file.

---

Use the command line in accordance with the following patterns in a batch file or in a window with the DOS command prompt.

### *Step by Step*

- 1) If a system update was performed after the last silent installation, repeat exactly the same command line with the new `CommunicationsClients.exe` file as was done with the earlier `CommunicationsClients.exe` file (i.e., as if you wanted to reinstall the

components installed earlier with the new `CommunicationsClients.exe` file. It is only then that a silent uninstallation will be possible.

- 2) If you do not want to log the process, select one of the following command lines:

---

**INFO:** Note the correct notation for parameters in uppercase and lowercase letters.

---

- If you want to uninstall all the components:  
`CommunicationsClients.exe /passive REMOVE=ALL`
- If you want to uninstall multiple components, specify their corresponding parameters as a comma-separated list after `REMOVE=`, e.g., `myPortal` for Desktop / `myAttendant` and Fax Printer:  
`CommunicationsClients.exe /passive REMOVE=myPortal,FaxPrinter`
- If you want to uninstall only one component, enter the appropriate parameter after `REMOVE=`, e.g., `myPortal` for Desktop / `myAttendant`:  
`CommunicationsClients.exe /passive REMOVE=myPortal`

- 3) If you want to log the process in a file, e.g., in `C:\ccuninstall.log`, select one of the following command lines:

---

**INFO:** Note the correct notation for parameters in uppercase and lowercase letters.

---

- If you want to uninstall all the components:  
`CommunicationsClients.exe /passive /L*V "C:\ccuninstall.log" REMOVE=ALL`
- If you want to uninstall multiple components, specify their corresponding parameters as a comma-separated list after `REMOVE=`, e.g., `myPortal` for Desktop / `myAttendant` and Fax Printer:  
`CommunicationsClients.exe /passive /L*V "C:\ccuninstall.log" REMOVE=myPortal,FaxPrinter`
- If you want to uninstall only one component, enter the appropriate parameter after `REMOVE=`, e.g., `myPortal` for Desktop / `myAttendant`:  
`CommunicationsClients.exe /passive /L*V "C:\ccuninstall.log" REMOVE=myPortal`

## 12.2.9 Automatic Updates

Automatic updates ensure that the UC clients are always kept up-to-date with the latest version.

If a new version is available, the update will either be installed automatically or you will be notified that an update is available. If necessary, a message is

displayed indicating that one or more applications must be closed to perform the update.

---

**INFO:** We recommend that you always perform the updates offered. This also applies to software that is required for certain UC clients.

---

## 12.3 Users and User Profiles of the UC Suite

Users of UC Suite are the subscribers who use the UC clients of UC Suite. User profiles store the settings of the users of UC Suite.

### 12.3.1 Users of UC Suite

UC Suite users use the UC clients of UC Suite. The settings of the UC Suite users are configurable in the user directory.

The user directory contains all the subscribers in the system. In order to use the UC clients, additional user data must be configured in the user directory.

---

**INFO:** Circuit users are not visible to the user directory as no license per user is assigned.

---

The following information is displayed in the user directory for every user:

- **Symbol for presence status**  
The administrator can change the presence status for every user.
- **Extension**
- **User name**  
Freely definable.
- **Name**  
First and last name, as configured for the subscriber.
- **Department**  
If a department is assigned to the user.
- **E-mail**  
E-mail address
- **Is Agent**  
Agent level for Multimedia Contact Center.
- **Voicemail**  
The user can receive voicemail.
- **Call Forwarding**  
Call forwarding is configured for the user.

Search functionality is also available for the user directory fields.

The following settings can be configured:

Values and settings	Keywords
<b>Personal details</b>	
My Personal Details	Own name, user name, password, e-mail address, department, additional phone number, XMPP ID
My Picture	My Picture
User Level	Receiving voicemails: see <a href="#">Stations</a> User as Attendant Console: see <a href="#">Stations</a> User as agent: see <a href="#">Stations</a>
<b>My Preferences</b>	
Presentation	Skin colors, language of the user interface
Notifications	Screen Pops
Calendar connectivity	Automatic creation of Outlook appointments when absent, automatic update of presence status via Outlook/iCal appointments
Hotkeys	Hotkey for functions
Miscellaneous	Automatic reset of the presence status, transfer method, retention period for Journal entries, server address, function keys of the telephone
<b>Call Rules</b>	
Forwarding destinations	Status-based Call Forwarding
Rules Engine	Rule-Based Call Forwarding
<b>Communications</b>	
Voicemail settings	Recording or announcement mode, language of the voicemail box
VM Notification	Notification Service for Messages
Fax Notification	Notification Service for Messages
<b>Profiles</b>	
Busy, No Answer, Meeting, Sick, Break, Away, Vacation, Lunch, Home Ph.	profile for personal AutoAttendant
<b>Sensitivity</b>	
Security and Access	Retrieval of your voice and fax messages by the Attendant; password check for the voicemail box
Presence Visibility	Visibility of your Presence Status for Others
VoiceMail Presence	Announcement of your presence status for external callers; announcement of your presence status for specific callers
<b>myAttendant</b>	

Values and settings	Keywords
LAN Messages	Text module for Instant Messaging
DIDs	MSN
Communications	Call forwardings

Additional information on user settings can be found in the User Guides of the UC clients and under the keywords listed in the table.

The password for UC clients consists of six digits by default. The password length can be adapted as required (6-10 characters). The maximum number of repeated characters is two and the maximum number of sequential characters is three. The account name (reversed or not) cannot be part of the password and the password change requires knowledge of the old password. The user is forced to change the default password after the first use. The maximum number of erroneous login attempts is five. An administrator with the **Advanced** profile can change the password of a user (if the user has forgotten it, for example).

---

**INFO:** The First Name and Last Name of a user are overwritten in the User Directory when they are changed by using a wizard or in Expert mode. By contrast, if the First Name and Last Name of a user are changed in the User Directory, the user data displayed when using a wizard or in Expert mode are not overwritten. This results in the existence of two different user names for the same user. Additionally, if the length of first name and the length of last name is greater than 16 characters in total, then it will be truncated to 16 in order to fit to display of the device.

---

Subscribers for whom an e-mail address has been configured and who use myPortal for Desktop receive a welcome e-mail with Getting Started Instructions.

### Resetting User Data

The settings of a user can be reset to default values. All the user's voicemail messages, personal greetings for the voicemail box, journal entries, scheduled conferences, e-mails and faxes are deleted in the process.

## 12.3.1.1 How to Configure UC Suite Users

### Prerequisites

- You are logged on to the WBM with the **Advanced** profile.

### Step by Step

- 1) In the navigation bar, click on **Setup**.
- 2) Click in the navigation tree on **Wizards > UC Suite**.
- 3) Click on **Edit** to start the **User Directory** wizard. All users are displayed.
- 4) Mark the desired user and click **Edit**.

- 5) Edit the data of the user.
- 6) Click on **Save**. The window is automatically closed. All users are displayed.
- 7) If you want to configure another user, repeat steps 4 through 6.

### 12.3.1.2 How to Reset UC Suite Users

#### *Prerequisites*

- You are logged on to the WBM with the **Advanced** profile.

#### *Step by Step*

- 1) In the navigation bar, click on **Setup**.
- 2) Click in the navigation tree on **Wizards > UC Suite**.
- 3) Click on **Edit** to start the **User Directory** wizard. All users are displayed.
- 4) Mark the desired user and click **Reset User**.
- 5) Click on **Save**. The window is automatically closed. All users are displayed.
- 6) If you want to reset another user, repeat steps 4 through 5.

### 12.3.1.3 How to Configure UC Suite Users as Agents (myAgent)

#### *Prerequisites*

- You are logged on to the WBM with the **Advanced** profile.

#### *Step by Step*

- 1) In the navigation bar, click on **Setup**.
- 2) Click in the navigation tree on **Wizards > UC Suite**.
- 3) Click on **Edit** to start the **User Directory** wizard. All users are displayed.
- 4) Click in the row with the relevant user.
- 5) Click **Edit**.
- 6) Click on **Personal Details > User Level**.
- 7) Select one of the following options:  
  
If the agent is to be permanently available, select the **Permanently available agent** check box. The agent will then remain available for calls, faxes and e-mails even when he or she does not accept a call, fax or e-mail.  
  
If the agent is not to be permanently available, clear the **Permanently available agent** check box. The agent will then be assigned the status Unavailable when he or she does not accept a call, fax or e-mail.
- 8) In the **Level** drop-down list, select the desired role for this agent: **Agent**, **Supervisor** or **Administrator**.



- 9) Click **Save**.
- 10) If you want to configure another user as an agent, repeat steps 4 through 9.

### 12.3.1.4 How to Change the Presence Status for a UC Suite User

#### *Prerequisites*

- You are logged on to the WBM with the **Advanced** profile.

#### *Step by Step*

- 1) In the navigation bar, click on **Setup**.
- 2) Click in the navigation tree on **Wizards > UC Suite**.
- 3) Click on **Edit** to start the **User Directory** wizard. All users are displayed.
- 4) Select the desired user.
- 5) Select the relevant presence status from the drop-down list and, if necessary, enter the time of return in the format `yyyy/mm/dd hh:mm`, e.g., `2012/12/12 12:00`.
- 6) Click on **OK**.
- 7) If you want to change the presence status for another user, repeat steps 4 through 6.
- 8) Close the window.

### 12.3.1.5 How to Change the Password for a UC Suite User

#### *Prerequisites*

- You are logged on to the WBM with the **Advanced** profile.

#### *Step by Step*

- 1) In the navigation bar, click on **Setup**.
- 2) Click in the navigation tree on **Wizards > UC Suite**.
- 3) Click on **Edit** to start the **User Directory** wizard. All users are displayed.
- 4) Mark the corresponding user and click **Edit**.
- 5) Under **Password**, click on **Change**.
- 6) Enter the new password under **New**.
- 7) Enter the new password under **Confirm**.
- 8) Click on **OK**. The window is automatically closed. All users are displayed.
- 9) If you want to change the password of another user, repeat steps 4 through 8.

**Next steps**

Notify the affected user(s) about the new password.

### 12.3.1.6 How to Change the Password Length for UC Suite Users

**Prerequisites**

- You are logged into the WBM with the **Expert** profile.

**Step by Step**

- 1) In the navigation bar, click on **Expert Mode**.
- 2) In the navigation tree, click on **Applications > OpenScape Business UC Suite**.
- 3) Click on **Server**.
- 4) Click on **General Settings**.
- 5) Enter the minimum required password length (6-10) for the future in the **Password Length** field.
- 6) Click on **Save**.

### 12.3.2 User Profiles for the UC Suite

User profiles of the UC Suite store the settings of the UC Suite users. One or more users (members) can be assigned to a user profile. All members of this profile have the same settings.

Every user can be a member of no more than one user profile. Direct changes to the settings of a user - i.e., not via the assigned profile - automatically delete the user from the profile.

If a user is unassigned from a profile they retain the settings that are represented by this profile.

If an entire profile is deleted, users that were assigned to this profile also retain profile's settings.

The following values and settings can be configured:

Menu items	Values and settings for
<b>Personal details</b>	
My Personal Details	Visibility of phone numbers
<b>My Preferences</b>	
Appearance	Skin colors, language of the user interface
Notifications	Screen pops

Menu items	Values and settings for
Outlook connectivity	Automatic creation of Outlook appointments when absent, automatic update of presence status via Outlook/iCal appointments
Miscellaneous	Automatic reset of the presence status, transfer method, retention period for Journal entries, server address
<b>Call Rules</b>	
Forwarding destinations	Status-based call forwarding
<b>Communications</b>	
Voicemail settings	Recording or announcement mode, language of the voicemail box
VM Notification	Notification Service for Messages
Fax Notification	Notification Service for Messages
<b>Profiles</b>	
Busy, No Answer, Meeting, Sick, Break, Away, Vacation, Lunch, Home Ph.	Profile for personal AutoAttendant
<b>Sensitivity</b>	
Security and Access	Retrieval of your voice and fax messages by the Attendant; password check for the voicemail box
Presence Visibility	Visibility of your Presence Status for Others
VoiceMail Presence	Announcement of your presence status for external callers; announcement of your presence status for specific callers

Additional information on user profile settings can be found in the User Guides of the UC clients and under the keywords listed in the table.

### 12.3.2.1 How to Add a UC Suite User Profile

#### *Prerequisites*

- You are logged on to the WBM with the **Advanced** profile.

#### *Step by Step*

- 1) In the navigation bar, click on **Setup**.
- 2) Click in the navigation tree on **Wizards > UC Suite**.
- 3) Click on **Edit** to start the **Profiles** wizard. All user profiles and their members are displayed.
- 4) Click on **Add**.
- 5) Enter the desired name for the profile under **Name**.

## UC Suite

### Users and User Profiles of the UC Suite

- 6) Click on **Save**.
- 7) Configure the desired settings for the user profile.
- 8) Click on **Save** and close the window.

#### 12.3.2.2 How to Edit a User Profile of the UC Suite

##### *Prerequisites*

- You are logged on to the WBM with the **Advanced** profile.

##### *Step by Step*

- 1) In the navigation bar, click on **Setup**.
- 2) Click in the navigation tree on **Wizards > UC Suite**.
- 3) Click on **Edit** to start the **Profiles** wizard. All profiles and their users are displayed.
- 4) Select the desired profile.
- 5) Click on **Edit**.
- 6) Change the desired values and settings.

---

**INFO:** Click on **Save** before you switch to a different menu item so that your changes are applied.

---

- 7) Then click **Save** and close the window.

#### 12.3.2.3 How to Display the User Profiles of the UC Suite

##### *Prerequisites*

- You are logged on to the WBM with the **Advanced** profile.

##### *Step by Step*

- 1) In the navigation bar, click on **Setup**.
- 2) Click in the navigation tree on **Wizards > UC Suite**.
- 3) Click on **Edit** to start the **Profiles** wizard. All user profiles and their members are displayed.

#### 12.3.2.4 How to Add Members to a UC Suite User Profile

##### *Prerequisites*

- You are logged on to the WBM with the **Advanced** profile.

### **Step by Step**

- 1) In the navigation bar, click on **Setup**.
- 2) Click in the navigation tree on **Wizards > UC Suite**.
- 3) Click on **Edit** to start the **Profiles** wizard. All user profiles and their members are displayed.
- 4) Select the desired user profile and click **Assign Users**.
- 5) Select the desired members from the **Available Users** list.
- 6) Click on <- to transfer them to the **Assigned Users** list.  
All station profiles and their members are displayed.
- 7) Close the window.

## **12.3.2.5 How to Delete Members from a UC Suite User Profile**

### **Prerequisites**

- You are logged on to the WBM with the **Advanced** profile.

### **Step by Step**

- 1) In the navigation bar, click on **Setup**.
- 2) Click in the navigation tree on **Wizards > UC Suite**.
- 3) Click on **Edit** to start the **Profiles** wizard. All user profiles and their members are displayed.
- 4) Select the desired user profile and click **Assign Users**.
- 5) Select the relevant members from the **Assigned Users** list.
- 6) Click on -> transfer them to the **Available Users** list.  
All station profiles and their members are displayed.
- 7) Close the window.

## **12.3.2.6 How to Delete a UC Suite User Profile**

### **Prerequisites**

- You are logged on to the WBM with the **Advanced** profile.

### **Step by Step**

- 1) In the navigation bar, click on **Setup**.
- 2) Click in the navigation tree on **Wizards > UC Suite**.
- 3) Click on **Edit** to start the **Profiles** wizard. All user profiles and their members are displayed.

- 4) Select the desired user profile.
- 5) Click on **Remove**.
- 6) Click **OK** to confirm your selection. All station profiles and their members are displayed.
- 7) Close the window.

## 12.4 Presence Status and CallMe Service

The Presence status and CallMe service display and optimize the availability of subscribers. The Presence status enables simple status-based call forwarding as well as rule-based call forwarding, which can be flexibly configured with myPortal for Desktop or myPortal for Outlook.

### 12.4.1 Presence Status (Presence)

The Presence status indicates the availability of internal subscribers (including mobile stations) in the Favorites list, the internal directory, the virtual conference room and via voicemail announcements. In addition, the Presence status controls the availability of internal subscribers with status-based call forwarding, rule-based call forwarding and the personal AutoAttendant.

As a subscriber, you can change your Presence status in myPortal for Desktop and myPortal for Outlook or via the menu controls of the voicemail box. Deactivating call forwarding at the telephone returns you to the **Office** presence status. For every change in the Presence status (except for **Office** and **CallMe**), you also define the scheduled time of your return to the **Office** or **CallMe** status.

As a subscriber, you can select the following statuses:

- **Office**
- **Meeting**
- **Sick**
- **Break**
- **Gone Out**
- **Vacation**
- **Lunch**
- **Gone Home**
- **Do Not Disturb** (not available for Mobility Entry or MULAP)

#### Mapping of the External XMPP Status Internally

Subscribers can see the presence status of external XMPP communication partners in the Favorites list or in the external directory, for example, provided XMPP has been configured. The following mappings apply (from left to right):

XMPP status	Represented as presence status
Online	Office
DND	Meeting
Away	Out of the Office
Extended Away	Vacation

---

**INFO:** Outlook contacts must include the XMPP ID in the IM address in accordance with the following pattern:

`xmpp:john.public@oso.example-for-a-domain.`

---

### Mapping of the Internal Presence Status Externally

External XMPP communication partners can see the XMPP status of internal subscribers, provided XMPP has been configured. The following mappings apply (from left to right):

Presence status	Represented as XMPP status
Office	Online
Meeting	DND
Sick	Away
Break	Away
Out of the Office	Away
Lunch	Away
Gone Home	Away
Vacation	Extended Away

### Call Forwarding to the Voicemail Box

If Presence status of a subscriber is not **Office** or **CallMe**, the communication system redirects calls for him or her to the voicemail box by default and notifies the callers via status-based announcements about the nature of absence and the scheduled time for return.

### Info Text

You can enter any info text for your current presence status, e.g., "I am in Room No. ..." when attending a meeting. The info text is displayed in the Favorites list, in the internal directory and in the virtual conference room. The info text is deleted when you change your presence status.

### Automatic Reset of the Presence Status

As a subscriber, you can have your Presence status automatically reset to **Office** at the end of your scheduled absence. Otherwise, the system extends the current Presence status in increments of 15 minutes until you change it yourself.

### Visibility of your Presence Status

As a subscriber, you can specify for each subscriber in the internal directory whether or not that subscriber can see your Presence status other than **Office** and **CallMe** as well as the scheduled time of your return and any info text you may have entered.

### Automatic Update of Presence Status via Outlook / iCal Appointments

As a subscriber, you can automatically control your Presence status via appointments (but not for those that have been proposed or declined) by using the specific keywords in the Subject line. You can choose between the following calendars:

- Exchange calendar (on the Microsoft Exchange Server)  
The automatic update of the presence status via Outlook appointments occurs independently, regardless of whether or not your PC is running. The administrator must configure the Exchange Calendar Integration for this function.

---

**INFO:** Information on the usage of the various Microsoft Exchange servers can be found in the Unify Experts wiki at [http://wiki.unify.com/wiki/OpenScape\\_Business#Microsoft\\_Exchange\\_Server](http://wiki.unify.com/wiki/OpenScape_Business#Microsoft_Exchange_Server).

---

- Outlook calendar  
The automatic update of the presence status via Outlook appointments requires myPortal for Desktop or myPortal for Outlook to have been started on your PC.
- iCal calendar (myPortal for Desktop)

You can use the following keywords:

- **Meeting**
- **Sick**
- **Break**
- **Gone Out**
- **Vacation**
- **Lunch**
- **Gone Home**

The keywords depend on the language set for the user interface. The keywords may be located anywhere in the Subject line. If the Subject line contains more than one such keyword, only the first takes effect. When this function is enabled, your Presence status changes automatically at the start and end time of the relevant appointment. The check for calendar appointments occurs at 30-second intervals.

---

**NOTICE:** When enabling this function, please bear in mind that any appointments with corresponding keywords in the Subject



line could lead to undesirable changes in your Presence status. Consequently, you may need to change the Subject line if needed.

---

### **Automatic Creation of Outlook Appointments when Absent)**

As a subscriber, you can have appropriate Outlook appointments created automatically when you are absent by a change in your Presence status. The Subject line of the corresponding Outlook appointment consists of your Presence status and the text "(Auto)", for example: "Meeting (Auto)". The start and end times for the appointment involved correspond to your entries in myPortal for Desktop or myPortal for Outlook. The end time of the Outlook appointment remains unchanged in the event of a possibly delayed return. You can define whether the Outlook appointments should be stored in the local PST file or on the Exchange server. If you are using a local PST file, your Outlook must be open when creating the Outlook appointments. If you are using a PST file on the Exchange server, the Outlook appointments are created, regardless of whether or not your Outlook is open. The administrator must configure the Exchange Calendar Integration for this function.

---

**INFO:** Information on the usage of the various Microsoft Exchange servers can be found in the Unify Experts wiki at [http://wiki.unify.com/wiki/OpenScape\\_Business#Microsoft\\_Exchange\\_Server](http://wiki.unify.com/wiki/OpenScape_Business#Microsoft_Exchange_Server).

---

### **Screen Pops on Changing the Presence Status**

As a subscriber, you can have changes to your Presence status indicated by a screen pop.

## **12.4.2 CallMe Service**

The CallMe service enables subscribers to define any phone at an alternative workplace as the CallMe destination at which they can be reached through their own internal phone numbers. The subscriber can use myPortal for Desktop or myPortal for Outlook at his or her alternative workplace exactly as in the office and thus also make outgoing calls from the CallMe destination.

### **Inbound Calls**

Inbound calls to the internal phone number are forwarded to the CallMe destination. The internal phone number of the called subscriber is displayed to the caller. Unanswered calls are forwarded to the voicemail box after 60 seconds.

### **Outbound Calls**

For outbound calls with myPortal for Desktop or myPortal for Outlook, the communication system sets up two connections. It first calls the subscriber at the CallMe destination. If the call is answered, the communication system then calls

the desired destination and connects the subscriber with it. The internal phone number of the caller is displayed at the destination (One Number Service).

### **Presence Status**

When the CallMe service is enabled, the message "CallMe active" appears in the display of the relevant phone (not for analog and DECT phones). Other subscribers see the presence status **Office**.

### **Activation**

As a subscriber, you can activate the CallMe service manually. In addition, the Call-Me service is also reActivated by an automatic reset of the Presence status following an absence, provided it was active earlier. Then following types of CallMe destinations are not supported:

- Group
- Redirected telephone

### **Displaying the CallMe Destination in the Favorites List**

As a subscriber, you can have the number of your CallMe destination displayed in the Favorites list of other subscribers instead of your own phone number.

### **Deactivation**

The CallMe service remains active until your Presence status changes.

---

**NOTICE:** CallMe function should not be used when dialing or calling in an open conference.

---

## **12.4.3 Status-based Call Forwarding**

Status-based call forwarding enables subscribers to forward calls based on their Presence status to one of their additional phone numbers or their voicemail box.

As a subscriber, you can configure status-based call forwarding for every presence status except **Office**, **CallMe** and **Do Not Disturb**. When you change your Presence status, the communication system activates call forwarding to the destination defined by you for this purpose. For example, if you are away from the office, to your mobile phone or if you are on vacation, to your representative.

## **12.4.4 Rule-Based Call Forwarding**

Rules-based call forwarding enables subscribers to forward calls based on numerous conditions and exceptions even more flexibly than with status-based call forwarding.

In addition, rule-based call forwarding also supports:

- Any destinations

- Presence status **Office**, **CallMe** and **Do Not Disturb**

As a subscriber, you can define rules and activate or deactivate them at any time by using the Rules wizard. A rule can only be active if your phone has not been forwarded. Status-based call forwarding (except to the voicemail box) overrides rule-based call forwarding.

When a call forwarding rule is active, "**rule active**" appears on the display of your telephone.

When an inbound call is received, the communication system checks the applicability of the active rule in accordance with its sequential order in the Rules wizard. Only the first applicable rule is executed. In this case, your phone will ring once, and the communication system will then forward your call to the defined destination.

You can define several types of conditions and exceptions (except when ...) in one rule. However, you cannot define a condition with an exception of the same type. For example, it is not possible to define a condition of the type "On certain weekdays" together with an exception of the type "Except on certain weekdays".

#### Types of Conditions and Exceptions

- (except) for certain Presence status
- (except) from certain people (in the internal directory, external directory, personal directory or from any station number)
- (except) when transferred to you from certain people (in the internal directory, external directory, personal directory or from any station number)
- (except) from a certain type, i.e., **internal**, **external** or **Unknown Contact**
- (except) on a certain date (also on multiple dates)
- (except) on certain weekdays
- (except) between a certain Start and End date
- (except) between a certain Start and End time

## 12.5 Directories and Journal

Directories, the Favorites List and the Journal organize contacts and calls.

### 12.5.1 Directories

Directories are used to organize the contacts of subscribers. Subscribers can access these contacts with UC Suite clients and via system phones with displays.

The system provides the following directories, which support the following functions and with the below priority for lookup number (lookup number will be supported only for external call and in case that CO/ITSP does not provide the name):

Directory	myPortal for Desktop, my Attendant, Fax Printer	myPortal for Outlook	System telephone with a display
Outlook Contacts MAC OS contacts (myPortal for Desktop )	If required, the subscriber can import Outlook/Mac OS contacts on starting myPortal for Desktop when using Microsoft Windows.	Contains the personal Outlook contacts of a subscriber. Only the subscriber involved has write access to this data.	Contains the personal Outlook contacts of a subscriber. Only the subscriber involved has write access to this data.
Personal directory	The subscriber can either import Outlook/Mac OS contacts on starting myPortal for Desktop or maintain personal contacts manually. Imported contacts cannot be edited.	-	Outlook contacts imported via the Personal Assistant.
Internal directory	The internal directory of UC Smart offers additional features with the UC Suite. Contains all internal subscribers, and groups for which the display has been activated in the system, possibly with additional phone numbers, provided the subscriber has made this information visible to other internal subscribers. Internal subscribers (with system telephones) are displayed with their Presence status and can be contacted through Instant Messaging. The Presence status of a subscriber can only be shown if allowed by that subscriber. If relevant, the scheduled time of return and any info text that may have been entered by the subscriber are also displayed. A subscriber is only provided read-access to this directory.		Contains all internal subscribers and groups for which the display has been activated in the system.
External directory	Contains contacts from a corporate directory and must be configured by the administrator. A subscriber is only provided read-access to this directory.		-
Public Exchange folder (not usable with Office 365)	Contains contacts of the public Exchange folder if configured by the administrator. These are shown in the external directory.  Information on the usage of the various Microsoft Exchange servers can be found in the Unify Experts wiki at <a href="http://wiki.unify.com/wiki/OpenScape_Business#Microsoft_Exchange_Server">http://wiki.unify.com/wiki/OpenScape_Business#Microsoft_Exchange_Server</a> .		-
External Offline Directory (LDAP)	Contains contacts from the LDAP corporate directory and must be configured by the administrator. The external offline directory can only used for searches. The administrator can enable and disable the display of the external offline directory for system telephones.		
System Directory	-		Includes all internal stations and all central speed-dial numbers. The administrator can enable and disable the display of a subscriber in the system directory.

---

**INFO:** Phone numbers in directories should always be entered in canonical format wherever possible.

---

---

**NOTICE:** In case the number is called from system phones it must be configured in canonical or diable format.

---

### Simple Search

As a subscriber, you can search the directories by **First Name**, **Last Name** or a call number. The directories are searched in the order shown in the table above. The search can be conducted using whole words and also with partial search terms such as a part of a station number, for example. The set search options remain in effect for subsequent searches. All search terms used are saved. You can optionally delete the list of search terms used.

### Advanced Search

You can selectively search in the **Title**, **First Name**, **Last Name**, **Company**, **Extension**, **Company Ph.**, **Business Ph. 1**, **Business Ph. 2**, **Home Ph. 1**, **Home Ph. 2**, **Mobile Number** and **Email** fields and limit the maximum number of hits. The modern interface of myPortal for Desktop does not support the advanced search. In a device only **Business Ph. 1**, **Home Ph. 1**, **Mobile Number** are supported.

### Sorting

The contacts of a myPortal for Desktop and myPortal for Outlook directory can be sorted by any column in ascending or descending alphanumeric order. The modern interface of myPortal for Desktop does not support sorting.

## 12.5.1.1 How to Configure Directories for System Telephones

### Prerequisites

- You are logged into the WBM with the **Expert** profile.

You can select which directories are to be made available on system telephones with displays.

### Step by Step

- 1) In the navigation bar, click on **Expert Mode**.
- 2) Click **Telephony Server > Basic Settings** in the navigation tree.
- 3) In the menu tree, click on **System > Display**.
- 4) Select one of the following options in the **Directory (phone book)** drop-down list:
  - If all the personal contacts, the internal, external and networking directory and the LDAP directory are to be made available, select **All**.
  - If only the personal contacts, the internal, external and networking directory is to be made available, select **Internal**.

- If only the LDAP directory is to be made available, select **LDAP**.
- If no directory is to be made available, select **No**.

---

**INFO:** The user can activate the search/lookup requests to be handled as requests to the Unified directory, by selecting the **Internal Phonebook via Unified Directory**. When the flag is deactivated and there is no access to Unified Directory, the list view at the phone-book menu, implemented for the OpenScape Desk Phone CP 200/205, is not available.

---

- 5) Click **Apply**.

### **Next steps**

If you have selected **All** or **LDAP**, make sure that an appropriate LDAP directory (e.g., Open Directory Service) is available for the system telephones.

## **12.5.2 Internal Directory**

The internal directory contains the contact details of the internal subscribers of the communication system. UC Suite clients can access the system directory.

As an administrator, you have unrestricted access to all data in the internal directory. As a subscriber, you can dial from the internal directory.

The administrator can disable the display for all analog stations or for analog stations without an associated name. Subscribers whose names begin with - are not displayed in the latter case.

### **12.5.2.1 How to Enable or Disable the Display of Analog Stations in the Internal Directory**

#### **Prerequisites**

- You are logged into the WBM with the **Expert** profile.

#### **Step by Step**

- 1) In the navigation bar, click on **Expert Mode**.
- 2) In the navigation tree, click on **Applications > OpenScape Business UC Suite**.
- 3) Click **Servers** in the menu tree.
- 4) Click on the **General Settings** tab.
- 5) In the **Analog Extensions** area, select one of the following options from the **Analog User Mode** drop-down list.
  - If all the analog stations are to be displayed in the internal directory, select **Show all**.

- If only analog stations with a name are to be displayed in the internal directory, select **Show named only**.

---

**INFO:** Analog stations with names beginning with '-' are not displayed in the latter case.

---

- If no analog stations are to be displayed in the internal directory, select **Not shown**.

6) Click **Save**.

### 12.5.2.2 How to Enable or Disable Searching the Internal Directory only

When dialing by name, you can configure either limiting the search only in the internal directory, or searching all directories in the network environment. The system is configured by default to search only in the internal directory.

#### *Prerequisites*

- You are logged into the WBM with the **Expert** profile.

#### *Step by Step*

- 1) In the navigation bar, click on **Expert Mode**.
- 2) In the navigation tree, click on **Applications> OpenScape Business UC Suite**.
- 3) Click **Servers** in the menu tree.
- 4) Click on the **General Settings** tab.
- 5) To enable searching only in the internal directory, select the check box **Dial by Name Search Local Extension only**.

---

**INFO:** The check box **Dial by Name Search Local Extension only** is enabled by default.

---

The system now searches only the internal directory when dialing by name. When the local extension is reached, the system plays the receiver's name, as long as it has been previously recorded.

- 6) To disable searching only in the internal directory, clear the check box **Dial by Name Search Local Extension only**.

The system now searches all directories in the network environment when dialing by name.

### 12.5.3 External Directory

The external directory includes contacts from outside the communication system.

The data of the external directory is available to all subscribers in all UC Suite clients and the phone display. Subscribers can dial from the external directory. Users with the UC Suite clients myAttendant and myAgent can also edit data in the external directory.

### Importing a CSV File

As an administrator, you can import contacts from a CSV file in UTF-8 encoding from the local file system or a network share into the external directory.

A header in the CSV file allows the mapping of field names in the CSV file to fields in the system. A typical CSV file may be structured as follows:

- Header line:  
"Customer ID","Last Name","First Name","Company Phone Number","Company Name":
- Data line:  
"987654","Dubios","Natalie","+498977712345","Company"

You can map the data being imported from the CSV file to the following fields in the system:

- Customer ID
- Title
- First Name
- Last Name
- Company
- Business Ph.
- Business Ph2
- Mobile Ph.
- Home
- XMPP ID
- Fax Ph.
- E-mail
- City

After processing the CSV template, the file must be saved in UTF-8 format in order to ensure the correct import of any existing special characters.

If you want the import to overwrite data, the corresponding **Customer IDs** should be identical.

---

**INFO:** A CSV template and a description of the syntax required for importing data into the external directory can be found under **Service Center > Documents > CSV Templates**.

---



### 12.5.3.1 How to Import a CSV File from the Local File System into the External Directory

#### *Prerequisites*

- You are logged on to the WBM with the **Advanced** profile.
- A suitable CSV file in UTF-encoding with data for the external directory is available in the local file system.

#### *Step by Step*

- 1) In the navigation bar, click on **Setup**.
- 2) Click in the navigation tree on **Wizards > UC Suite**.
- 3) Click **Edit** to start the **External Directory** wizard.
- 4) Select one of the following options:
  - If you want to load the CSV file from the local file system, select the **Local file** radio button and navigate to the CSV file in the **File Upload** area.
  - If you want to load the CSV file from a network share, select the **Common directory** radio button and enter the network share access data (name of the CSV file, domain name as well as user name and password for the share) in the **Common directory** area.  
Verify your input by clicking on **Test**.
- 5) Click in the **Source File** area on **Browse** and select the desired file.
- 6) Enter the number of header rows in the CSV file in the **Header Rows** field.
- 7) Enter the **Field separator** used in the CSV file.
- 8) Select one of the following options:
  - If you want to delete the existing data from the external directory, select the check box **Remove directory before Import**.
  - If you do not want to delete the existing data from the external directory, clear the check box **Remove directory before Import**.
- 9) In the **Processing identical customer IDs** area, select how the system should respond when trying to import data with existing customer IDs:
  - If you want the existing contacts to be overwritten by the data from the CSV file, select **Update contacts**.
  - If you want to keep the existing contacts, select **Retain existing contacts**.
- 10) Click **Next**.
- 11) Select the fields of the CSV file to be mapped to corresponding fields in the system sequentially from the drop-down lists. If the appropriate fields do not exist or if you do not want to import the data, click on **No Mapping**.
- 12) Click **Next**.
- 13) Click **Import**. Do not close this window while the data is still being imported. On completing the import, the number of imported records is displayed.

### 12.5.3.2 How to Add Access to an External Database for the External Directory

#### *Prerequisites*

- You are logged on to the WBM with the **Advanced** profile.
- The required data for accessing the external database is available.

#### *Step by Step*

- 1) In the navigation bar, click on **Setup**.
- 2) Click in the navigation tree on **Wizards > UC Suite**.
- 3) Click on **Edit** to start the **External Directory** wizard.
- 4) Click in the **Source File** area on **Browse** and select the desired file.

### 12.5.4 External Offline Directory (LDAP)

The external offline directory (LDAP) contains contacts from an LDAP server for myPortal for Desktop, myAgent, Fax Printer, myPortal for Outlook and for system telephones with displays.

The system supports LDAP Version 2 with authentication.

LDAP (Lightweight Directory Access Protocol) is a TCP/IP-based directory access protocol for accessing network directory services. LDAP has a unique format world-wide in which all names can be represented. It provides for different layouts and enables unique associations between names and their internal representation. This data is defined by the administrator together with the IT administrator of the customer when planning and setting up a project. LDAP can be used under the MS Windows and Linux operating systems.

In a Microsoft environment, the Active Directory Server (ADS) or the Exchange Server also serves as the LDAP server. Under Microsoft Windows, user data can be administered with the Active Directory (AD) application or ESTOS Metadir, for example. The administration of this data is generally performed by the IT administrator of the customer.

Under Linux, the user data can be administered with OpenLDAP, for example.

Setting up an LDAP directory service can be simplified with an LDAP browser (e.g., the freeware from Softerra).

Phone numbers on the LDAP server may only include "-" and blanks as delimiters. Other delimiters cannot be filtered out by the system.

As an administrator, you can adapt the mapping of fields to the names of the used LDAP server during the configuration of an external offline directory. Deleted fields are ignored when searching for names via phone numbers. The search always occurs with the last 4 positions of the phone number preceded by a

wildcard. You can deactivate the search for names via phone numbers for incoming calls.

If the default port 389 is already being used, some other port must be configured

---

**INFO:** More information can be found on the Internet at <http://wiki.unify.com>.

---

The data of the external directory is available to subscribers in myPortal for Desktop, myAttendant, Fax Printer and myPortal for Outlook during the search.

### System Telephones with Displays

As a subscriber, you can select between the internal directory and the LDAP directory via the menu., provided these have been configured for system telephones. The LDAP directory supports searches in the appropriate contacts and the subsequent calling of a contact.

The name information provided by the LDAP server is not displayed in ringing or call status. The call numbers for incoming calls are also not replaced by the name information provided by the LDAP server (as when call numbers are replaced by SSD names).

A system subscriber can only be reached from the LDAP directory if a DID number was configured for him or her and if this entry corresponds to the entry in the LDAP database. Call numbers provided by the LDAP server can only be routed within the network if the internal call number and the DID number are identical.

## 12.5.4.1 How to Add the External Offline Directory (LDAP) for PC Clients

### Prerequisites

- You are logged into the WBM with the **Expert** profile.
- You know the required access data for LDAP server.

### Step by Step

- 1) In the navigation bar, click on **Expert Mode**.
- 2) In the navigation tree, click on **Applications > OpenScape Business UC Suite**.
- 3) Click the **External Providers Config** tab.
- 4) Select one of the following options:
  - If you want to enable the resolution of phone numbers into names in the journal for external incoming calls, select the **Search by phone number** check box.

- If you want to disable the resolution of phone numbers into names in the journal for external incoming calls, clear the **Search by phone number** check box.
- 5) Click **Add**.
  - 6) Enter the access data of the LDAP server.
    - a) Enter a name for this external offline directory under **Name**.
    - b) Enter the name or the IP address of the LDAP server under **Server**.
    - c) Enter the port number of the LDAP server under **Port**.
    - d) Under **LDAP Basic DN**, enter the LDAP Base Distinguished Name, e.g., `dc=example-for-a-domain, dc=net`.
    - e) Enter the **User Name**.
    - f) Enter the **Password**.
  - 7) Enter the corresponding field designation of the LDAP server for the following fields: **Title, First Name, Last Name, Business Ph. 1, Business Ph. 2, Home, Mobile, Company, Company Ph., Postal Address, State, province or county, Country, Postal Code, E-mail, Pager, Fax Number, XMPP-ID** and **City**.
  - 8) Click **Save**.

#### 12.5.4.2 How to Delete the External Offline Directory (LDAP) for PC Clients

##### *Prerequisites*

- You are logged into the WBM with the **Expert** profile.

##### *Step by Step*

- 1) In the navigation bar, click on **Expert Mode**.
- 2) In the navigation tree, click on **Applications > OpenScope Business UC Suite**.
- 3) Click the **External Providers Config** tab.
- 4) Click on the external offline directory to be deleted.
- 5) Click **Remove**.

#### 12.5.4.3 How to Add an External Offline Directory (LDAP) for System Telephones

##### *Prerequisites*

- You are logged into the WBM with the **Expert** profile.
- You know the required access data for LDAP server.

### Step by Step

- 1) In the navigation bar, click on **Expert Mode**.
- 2) Click **Telephony Server > Basic Settings** in the navigation tree.
- 3) In the menu tree, click on **System > LDAP**.
- 4) Enter the **IP address of the LDAP server**.
- 5) Enter the **Port number for LDAP access**.
- 6) Enter the **User Name**.
- 7) Enter the **Password**.
- 8) Enter the password again in the **Confirm password** field.
- 9) Under **Basic DN**, enter the LDAP Base Distinguished Name of the LDAP server, e.g., `dc=example-for-a-domain, dc=net`.
- 10) Under **Search query**, enter the search string for the LDAP server, e.g.:  
`cn=$*`.
- 11) Enter the **Result attribute, Name** for the LDAP server, e.g.: `cn`.
- 12) Enter the **Result attribute, Station number** for the LDAP server, e.g.:  
`telephoneNumber`.
- 13) Select one of the following options for sorting the search results:
  - If you want to have the search results sorted, select the **Sort search results** check box.
  - If you do not want to have the search results sorted, clear the **Sort search results** check box.
- 14) Enter the **LDAP seizure code**.
- 15) Enter the **LDAP station number prefix**.
- 16) Click on **Apply**.

### Next steps

*How to Configure Directories for System Telephones*

## 12.5.5 System Directory

The system directory contains all internal stations. UC Suite clients can access the system directory.

The administrator individually disable the display for every subscriber and every speed-dial number with a name.

## 12.5.6 Unified Directory

OpenScape Business provides different data sources to store and to retrieve user or contact related data, starting with the internal user data in the internal user

configuration, via the internal speed dial list, up to the different directories of the UC applications.

Each data source within OpenScope Business is used by a specific client application either located within the system SW itself in the phone devices or within a UC client application. Depending on the used data sources and the used clients, the retrieved data and their presentation is different.

The "Unified Directory" service within OpenScope Business comprises the existing OpenScope Business data sources for common search and name resolution functions. It provides the same search result or name resolution information to all system devices and OpenScope Business clients.

The Unified Directory service can either be accessed via the Web Service Interface (WSI) from externally located clients like myPortal to go or internally via the call processing mechanisms (e.g. from OpenStage

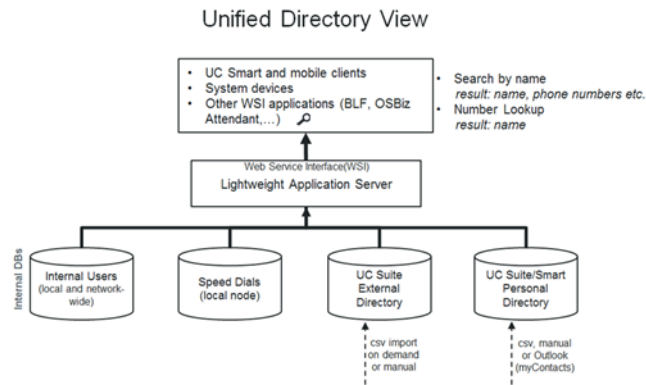

Phones).

Unified Directory uses following internal databases and directories of OpenScope Business:

- Internal user directory (network wide)
- Speed dial lists
- UC Smart Personal Directory (optional)
- UC Suite External Directory (optional)
- Personal Outlook Contacts (if imported via myContacts)

The Unified Directory service is available within every OpenScope Business system from V2R2 on. It does not require specific HW-SW or license prerequisites.

In order to get best results when using the Unified Directory some rules regarding phone number formats and writing of names have to be followed.

### 12.5.6.1 Features

Unified Directory Service provides:###P###

- Directory Search in several internal data sources of OpenScope Business
- Unified offering of the search result to all supported clients

- Phone number Look-Up / Name Resolution in several internal data sources
- Unified offering of name resolution results for all supported clients
- External data access via the WebServices Interface (WSI)

The features are available for single node systems as described in the following. Within OpenScope Business networks, the availability of the features depends mainly on the kind of connection of the trunks, devices and clients within the network.

### Supported Devices / Clients

Unified Directory supports following clients / system devices of Unify using the indicated interfaces:

Device/Client	Used Interface/Protocol	Remarks
OpenStage phones	Call Processing / HFA protocol	WSI / HTTP(S) is optional on OpenStage 60/80 for caller images
OpenScope Deskphone IP	Call Processing / HFA protocol	WSI / HTTP(S) is optional on DeskPhone IP 55 for caller images
Cordless (CMI) devices	Call Processing / CMI protocol	
CP200	Call Processing / HFA protocol	
DeskPhone CP400/CP600	WSI / HTTP(S)	
myPortal Smart	WSI / HTTP(S)	
myPortal to go	WSI / HTTPS	
Openscape Business Attendant/BLF	Call Processing / CorNet protocol	WSI / HTTP(S) is optional

---

**INFO:** The UC Suite myPortal, myAttendant and myAgent clients use their own mechanisms for directory search and name resolution.

---

### Search function

The Unified Directory search is always performed by using the specific device / client user interface. The search criterions and the used character set could be restricted, depending on the used clients.

After the search criterion is entered the search is performed within subsequent directories

- Internal user directory (network wide)
- Speed dial lists
- UC Smart Personal Directory (optional)
- UC Suite External Directory (optional)
- Personal Outlook Contacts (if imported via myContacts)

All matches within the directories above are shown as search results together with their origin. The matches contain either the full contact data set or only parts of it. The information depth of the results depends on the data source.

The matches are presented at the devices or clients depending on display capabilities.

	Internal UserDirectory	SpeedDials	UC SmartPersonalDirectory	UC SuiteExternalDirectory	PersonalOutlookContacts (viamyContacts)
Last Name	X	---	X	X	X
First Name	X	---	X	X	X
Short/Displayname	X	X	---	---	---
Office Phone No.	---	---	X	X	X
Home/Ext. PhoneNo.	---	---	X	---	X
Mobile Phone No.	---	---	X	X	X
XMPPID	---	---	---	X	---
Email-Adr.	---	---	X	X	X
Company name	---	---	X	X	X
City	---	---	---	---	---
Contact Picture	---	---	X	---	X
Contact Picturepreview	---	---	X	---	X

**Phone Number Look-Up**

Unified Directory Phone number Look-Up resolves the transferred calling party (CLI) by a number search in all supported internal data sources. The search is performed within following phone number fields:

- Office number
- Mobile number
- Home number

The Phone number Look-Up is triggered in case of incoming or outgoing calls in general, whereas specific routing and forwarding features are considered in addition.

A fixed prioritization of the data sources that are used for Phone number Look-Up is implemented in order to get the result as fast as possible. The result contains



either only lastname, firstname, displayname or ,if available, the full related contact data.

**Table:** Supported Data Sources and Prioritization

Priority	Data Sources	Remark
1	CO/ITSP name (as sent by provider)	Prerequisite is to enable flag "Name in CO".
2	Speed dial list	
3	Personal Contacts	
4	UC User detail	

The retrieved data are presented on the user's device and/or in the UC client. The information depth depends on the display capabilities.

- **Incoming calls**

Supported scenario for single node systems:

- Basic call
- Group call/ MULAP call
- Ringing Group
- Single Step Call Transfer (SSCT)
- Attended/Supervised/Consultation Transfer
- Call Forwarding Unconditional (CFU)
- Call Forwarding No Reply (CFNR)
- Call Forwarding Busy (CFB)
- Blind transfer
- Call Pickup

Supported scenario for multi node (network) scenarios is a Gateway Call.

- **Outgoing call**

In case of an Outgoing Call the Phone number Look-Up of the called partynumber happens only once.

Supported scenario for single node systems is a Basic Call to externalnumber.

The presentation of the Phone number Look-Up result depends on display capabilities of the phones.

## 12.5.6.2 Rules and Conventions

Some conventions regarding number and name formats within the data sources have to be observed in order to get optimal results using the Unified Directory service.

### Supported Number Format

All external phone numbers within the data sources must be entered in the canonical format including country and area code. e.g.+4989700712345

---

**INFO:** Speed Dial list supports only system dialable format e.g. 0089700712345 or 0004989700712345

---

### Supported Name Formats

The following conventions regarding name formats and character sets have to be observed:

- **Speed dial name format**  
Name search within the Speed Dial List is supported only with specific configuration rules. The first and last names have to be entered within the existing name field using the following pattern:  
<Last Name>, <First Name> (comma separated)
- **Internal Users in case of Migrations**  
Migration to V2R1 and onwards with internal users that do not follow these configuration rules will not be supported in the expected way. This means the administrator should convert internal names to the following pattern before migration:  
<Last Name>, <First Name> (comma separated)

### Availability of directory changes

After creating, updating or deleting contacts in the various data sources it can take up to 10 minutes until all changes appear on Phone number Look-Up results.

## 12.5.6.3 Functional Boundaries

The following functional boundaries do exist regarding Unified Directories:

### Name Search

- Group name support  
Group names (not MULAP names) can currently not be searched in all kind of configurations
- Support of special characters  
On most phone devices the user can only search for standard characters "a-z". Special (diacritical) characters like German characters Ää, Öö, Üü, ß are not accessible via phone device user interface. Therefore special characters are not supported in search filter.  
Names including special characters cannot be searched via the Unified Directory.
- Support of Speed Dial Name format  
Name search within the Speed Dial List is supported only with specific configuration rules. The first- and last names have to be entered within the existing name field using one of the following patterns
  - <Last Name>, <First Name> (comma separated )
  - <First Name> <Last Name> (space separator on this case)

### Name Presentation

Personal Contacts in UC Smart and from external offline directory, with length of first name plus length of last name greater than 24 characters, will be truncated to 24 characters length to fit the display length of the devices.

### Phone number Look-up

The Phone number Look-Up feature (retrieve contact name from calling party number) is not supported in Unified Directory for SIP and S0 devices.

## 12.5.6.4 Unified Directory in Networked Systems

The Unified Directory Service is active within every node of an OpenScape Business Network and uses the datasources of the own system. Phone Devices and Client use always the Unified Directory Service within their own node.

Therefore it depends on the kind of datasource content if netwide contacts are available.

**Table:** Local and Netwide Datasource

Data source	Local data	Netwide data
Internal user directory	X	X
Speed dial lists	X	---
UC Smart Personal Directory	X	---
UC Smart Personal Directory	X	---
Personal Outlook Contacts (via myContacts)	X	---

### Phone number Look-up

In Networking scenarios the Phone number Look-Up functionality is not used. In such scenarios the name is transported via normal networking mechanisms between the network nodes.

For internal users the configured Display Name is used so Lookup is not required.

## 12.5.6.5 How to Import Contacts to Unified Directory

Import contacts wizard offers the functionality to import directory contacts from a csv file.

### Prerequisites

- You are logged into the WBM with the **Expert** profile.

### Step by Step

- 1) In the navigation bar, click on **Setup**.
- 2) In the navigation tree, click **Wizards > Unified Directory**.
- 3) Click on **Edit** next to **Import Contacts**, to proceed with the importing of the contacts to the Global Directory.
- 4) Under **File Upload** section, click on **Choose File** and select the desired csv file to upload.

---

**INFO:** The maximum amount of entries per import is 100,000 (30,000 for embedded systems).

---

- 5) Under **Options** section, enter the **File separator**. ';' or ',' are valid entries.
- 6) Click **OK & Next**.
- 7) Backend processes the file, reads the headers and presents the headers together with the predefined categories of the Master Directory into the **CSV Header Mapping** page. Then the user can match the entries of the csv files in order to import the relative data to desired categories other than the predefined.
- 8) Click **OK & Next**.
- 9) Into the **Overview of Import** page:
  - a) Select one of the following options about the imported csv file:
    - Append global directory contacts
    - Delete all global directory contacts imported via CSV
    - Delete all global directory contacts
  - b) Regarding **Duplicated Customer ID** select one of the following options:
    - Update existing customer
    - Stop importing current record

The entries which will be added and the entries which failed to be validated are presented into two corresponding tables.

---

**INFO:** Duplicate records are identified by combination of First Name, Last Name, Business Phone and Email fields. These fields cannot be automatically updated by choosing "**Update existing customer**". In order to update these fields, see Chapter "How to Edit or Add new Unified Directory Contacts" or choose to delete first older records in step 9a.

---

- 10) Click **OK & Next**. Several minutes may be required for this process.
- 11) **Import Finished** page informs regarding the number of the entries which were imported.
- 12) Click on **Finish**.

## 12.5.6.6 How to Edit or Add new Unified Directory Contacts

Edit contacts wizard offers the functionality to edit the already imported contacts or add a new one.

### *Prerequisites*

- You are logged into the WBM with the **Expert** profile.

### *Step by Step*

- 1) In the navigation bar, click on **Setup**.
- 2) In the navigation tree, click **Wizards > Unified Directory**.
- 3) Click on **Edit** next to **Edit Contacts**, to proceed with the editing of the contacts of the Global Directory.
- 4) Edit the desired fields of the contacts. Only when an entry is edited then **Apply** button becomes available.
- 5) Click on **Add** to manually add a new contact.
- 6) Fill the desired fields of the new contact and click on the **Apply** button.

## 12.5.7 Departments

Departments classify subscribers in the internal directory into groups based on their organizational affiliation. The internal directory allows you to search and sort by department.

### 12.5.7.1 How to Add a Department

#### *Prerequisites*

- You are logged on to the WBM with the **Advanced** profile.

#### *Step by Step*

- 1) In the navigation bar, click on **Setup**.
- 2) Click in the navigation tree on **Wizards > UC Suite**.
- 3) Click on **Edit** to start the **Departments** wizard.
- 4) Click on **Add**.
- 5) Enter the **Name** of the Department.
- 6) Enter the **Group number**.
- 7) Click on **Save**.

## 12.5.7.2 How to Assign Stations to a Department

### *Prerequisites*

- You are logged on to the WBM with the **Advanced** profile.

### *Step by Step*

- 1) In the navigation bar, click on **Setup**.
- 2) Click in the navigation tree on **Wizards > UC Suite**.
- 3) Click on **Edit** to start the **User Directory** wizard.
- 4) Select the relevant station.
- 5) Click on **Edit**.
- 6) Select the desired department from the list box in the **Dept** field.
- 7) Then click **Save**.

## 12.5.7.3 How to Edit a Department

### *Prerequisites*

- You are logged on to the WBM with the **Advanced** profile.

### *Step by Step*

- 1) In the navigation bar, click on **Setup**.
- 2) Click in the navigation tree on **Wizards > UC Suite**.
- 3) Click on **Edit** to start the **Departments** wizard.
- 4) Click in the list of departments on the appropriate department.
- 5) Click on **Edit**.
- 6) Enter the **Name** of the Department.
- 7) Enter the **Group number**.
- 8) Click on **Save**.

## 12.5.7.4 How to remove a Department

### *Prerequisites*

- You are logged on to the WBM with the **Advanced** profile.

### *Step by Step*

- 1) In the navigation bar, click on **Setup**.
- 2) Click in the navigation tree on **Wizards > UC Suite**.

- 3) Click on **Edit** to start the **Departments** wizard.
- 4) Click in the list of departments on the appropriate department.
- 5) Click on **Remove**.
- 6) Click on **OK**.

## 12.5.8 Favorites List

The Favorites list provides you (as a subscriber) with a constant view of selected contacts. These contacts can also be called very easily directly from the Favorites list. All internal subscribers with system telephones and external XMPP communication partners are shown together with their Presence status and can be contacted via instant messaging.

As a subscriber, you can add contacts from all directories to the Favorites list. For favorites that do not come from the internal directory, instead of the symbol for the Presence status, the symbol for the source of the contact is displayed.

The Favorites list manages contacts in groups. The contacts in all groups can be sorted by First Name, Last Name or their original sorting order.

When an internal subscriber is absent, you can determine the scheduled time of his or her return by positioning the mouse pointer over the entry for that subscriber, provided the subscriber has allowed his or her Presence status to be visible to you.

For favorites with multiple phone numbers, you can specify a default number with which the contact is to be called. The default phone number of a favorite can be determined in the context menu from the symbol with the activated check box.

## 12.5.9 Journal

The journal is the list of all incoming and outgoing calls of a subscriber. It enables subscribers to quickly and easily respond to missed calls and call back their contacts or call them again directly from within the journal.

### Folder for Call Types

The calls are arranged in the following groups:

- **Open**  
Contains the unanswered missed calls for which a call number was transmitted. As soon as one of these calls is answered, all associated entries with that call number are dropped from the list.
- **All calls**
- **Missed**
- **Answered**
- **Internal**
- **External**

- **Inbound**
- **Outbound**
- **Scheduled**

Contains all the calls that you (as a subscriber) have scheduled for specific dates/times. The Scheduled Calls feature is not available to Contact Center agents. In order for the communication system to execute a scheduled call, myPortal for Desktop or myPortal for Outlook must be open at the scheduled time; your presence status must be **Office** or **CallMe**, and you must confirm the execution of the call in a dialog. If you are busy at the time the scheduled call is to be made, the system defers the scheduled call until you are free again. myPortal for Desktop or myPortal for Outlook informs you of any pending scheduled calls on exiting the program. On starting the application, myPortal for Desktop or myPortal for Outlook notifies you about any scheduled calls for which the scheduled time has elapsed. You can then either delete such calls or save them with a new scheduled time.

Not all folders for call types are available in the modern user interface myPortal for Desktop.

### **Retention Period**

The system saves a record of the calls in the Journal for a maximum period of time, which can be configured by the administrator. As a subscriber, you can reduce this time. After the retention period expires, the system automatically deletes all associated entries.

---

**INFO:** The retention period also determines the maximum time period for evaluations with myReports.

---

### **Grouped by time period**

The calls in each group are arranged by time, e.g.: Today, Yesterday, etc., Last Week, Last Month and Older. Your administrator can set the duration for which calls should be saved in the Journal. After this set time period expires, the entries are automatically deleted. The grouping by time period is not available in the modern user interface of myPortal for Desktop.

### **Call Details**

Every call is shown with the Date and Time and, if available, with the call number. If a directory contains further details on the call number such as the **Last Name**, **First Name** and **Company**, then this information is also shown. In addition, the **Direction**, **Duration** and **Call Complete** columns are also displayed in most folders. Not all call details are available in the modern user interface of myPortal for desktop.

### **Sorting**

You can sort the calls in the Journal by any column in ascending or descending alphanumeric order.

You can jump within the Journal to the first call whose entry begins with a specific character in the sorted column, e.g., to the first Last Name beginning with "P". By



entering subsequent characters, you can then narrow the search. Sorting is not available in the modern user interface of myPortal for Desktop.

### Export

As a subscriber, you can export the journal as a CSV file using myPortal for Desktop or myPortal for Outlook:

## 12.5.9.1 How to Change the Maximum Retention Period for the Journal

### Prerequisites

- You are logged into the WBM with the **Expert** profile.

### Step by Step

- 1) In the navigation bar, click on **Expert Mode**.
- 2) In the navigation tree, click on **Applications > OpenScape Business UC Suite**.
- 3) Click on **Server**.
- 4) Click on **Maintenance**.
- 5) Enter the desired duration in days in the **Keep call history for** field.

---

**INFO:** The retention period also determines the maximum time period for evaluations with myReports.

---

- 6) Click on **Save**.

## 12.6 Calls

For calls, convenient features such as a desktop dialer, screen pops and the option to record calls and conferences are available to subscribers.

### 12.6.1 Desktop Dialer and Clipboard Dialer

The Desktop Dialer and Clipboard Dialer enable users with myPortal for Desktop (Windows) or myPortal for Outlook to call a selected destination or a destination copied to the Windows clipboard via a key combination from many Windows applications, e.g., from an Outlook e-mail.

Depending on the type of string used, the Dialer works as follows:

- A phone number in canonical format is dialed directly.

- A station number in dialable format is dialed directly if the communication system can decide whether an internal or external destination is involved. Otherwise, the user is asked to make the appropriate selection.
- A string containing letters is searched in the directories as a first name or company.

The Desktop Dialer and Clipboard Dialer are executed after a definable time period. During this period, the dialing can still be canceled. If the preset value of 3s is changed to 0s, the dialing will be executed immediately. The value is changed in the settings of the UC Suite clients.

Windows applications that were implemented with standard Windows-compliant components usually support the Desktop Dialer and Clipboard Dialer, but 16-bit applications do not. The Desktop Dialer is only supported by 32-bit applications.

## 12.6.2 Screen Pops

Screen pops in the UC Suite clients offer you convenient ways to respond to incoming calls or new voicemails with a single mouse click, for example.

Screen pops appear in the lower right corner of the screen. There are different types of screen pops. Screen pops for calls and messages show phone number, name and image of the caller, if possible. The buttons in the screen pops change, depending on the situation.

Screen pops can be minimized to a tray icon. As soon as more than three screen pops are opened for calls, they are automatically minimized and shown as icons on the task bar.

## 12.6.3 Record calls

A subscriber can record calls. Recorded calls appear in the voicemail box.

---

**INFO:** Note that in most countries you are legally required to notify the other party that you are recording the call. In some countries (such as France, for example), the other party is automatically notified by the system.

---

As an administrator, you can allow or prevent the recording of calls and conferences on a system-wide basis. In addition, you can optionally configure the playback of an announcement or warning tone at the start of the recording.

As a subscriber, you can control the recording of calls via myPortal for Desktop or myPortal for Outlook. Recorded calls are identified in the voicemail box with a red dot and show the call number of the other party if available.

Ongoing recordings are automatically stopped by a consultation hold, placing a call on hold, transfers and the initiation of a conference.

---

**INFO:** DTMF is not supported during call recording.

---

### 12.6.3.1 How to Activate or Deactivate the Recording of Calls

#### *Prerequisites*

- You are logged into the WBM with the **Expert** profile.

#### *Step by Step*

- 1) In the navigation bar, click on **Expert Mode**.
- 2) In the navigation tree, click on **Applications > OpenScape Business UC Suite**.
- 3) Click on **Server**.
- 4) Click on **General Settings**.
- 5) Select one of the following options:
  - If you want to allow the recording of calls and conferences, select the **Record Call** check box.
  - If you want to prevent the recording of calls and conferences, clear the **Record Call** check box.
- 6) Click on **Save**.

---

**INFO:** Calls that have this functionality activated or any other conference based call cannot be transferred or held.

---

### 12.6.3.2 How to Activate or Deactivate the Recording Announcement

#### *Prerequisites*

- You are logged into the WBM with the **Expert** profile.

#### *Step by Step*

- 1) In the navigation bar, click on **Expert Mode**.
- 2) In the navigation tree, click on **Applications > OpenScape Business UC Suite**.
- 3) Click on **Server**.
- 4) Click on **General Settings**.
- 5) Select one of the following options:
  - If you want to play an announcement at the start of a recording, select the **Play prompt before recording** check box.

- If you do not want to play an announcement at the start of a recording, clear the **Play prompt before recording** check box.
- 6) Click on **Save**.

### 12.6.3.3 How to Activate or Deactivate the Warning Tone for Recording

#### *Prerequisites*

- You are logged into the WBM with the **Expert** profile.

#### *Step by Step*

- 1) In the navigation bar, click on **Expert Mode**.
- 2) In the navigation tree, click on **Applications > OpenScape Business UC Suite**.
- 3) Click on **Server**.
- 4) Click on **General Settings**.
- 5) Select one of the following options:
  - If you want to play a warning tone at the start of a recording, select the **Play pip tone before recording** check box.
  - If you do not want to play a warning tone at the start of a recording, clear the **Play pip tone before recording** check box.
- 6) Click on **Save**.

## 12.7 Conferences

In a conference, multiple participants (including external parties) can communicate with one another at the same time.

### 12.7.1 Conference Management

Conference management enables subscribers to use different types of conferences.

#### **Types of Conferences**

The different types of conferences offer the following features:

	Ad-hoc	Scheduled	Permanent	Open
Usage	<ul style="list-style-type: none"> <li>Phone-controlled</li> <li>application-controlled</li> </ul>	<ul style="list-style-type: none"> <li>application-controlled</li> </ul>	<ul style="list-style-type: none"> <li>application-controlled</li> </ul>	<ul style="list-style-type: none"> <li>application-controlled</li> </ul>
Start	<ul style="list-style-type: none"> <li>Manually</li> </ul>	<ul style="list-style-type: none"> <li>Scheduled</li> </ul>	<ul style="list-style-type: none"> <li>Manually</li> </ul>	<ul style="list-style-type: none"> <li>Manually</li> </ul>
End	<ul style="list-style-type: none"> <li>Manually</li> </ul>	<ul style="list-style-type: none"> <li>Scheduled</li> <li>Manually</li> </ul>	<ul style="list-style-type: none"> <li>Manually</li> </ul>	<ul style="list-style-type: none"> <li>Manually</li> </ul>
Duration of the reservation of conference channels	<ul style="list-style-type: none"> <li>1 hour by default</li> </ul>	<ul style="list-style-type: none"> <li>Scheduled</li> </ul>	<ul style="list-style-type: none"> <li>Until the deactivation or deletion of the conference</li> </ul>	<ul style="list-style-type: none"> <li>Until the deactivation or deletion of the conference</li> </ul>
Extension	x	x	-	-
Recurrence	<ul style="list-style-type: none"> <li>Manually</li> </ul>	<ul style="list-style-type: none"> <li>Scheduled</li> </ul>	-	-
Direction of connection setup from the viewpoint of the system	<ul style="list-style-type: none"> <li>Outbound</li> </ul>	<ul style="list-style-type: none"> <li>Outbound</li> <li>Inbound</li> </ul>	<ul style="list-style-type: none"> <li>Inbound</li> </ul>	<ul style="list-style-type: none"> <li>Inbound</li> </ul>
Set of participants	<ul style="list-style-type: none"> <li>Fixed</li> </ul>	<ul style="list-style-type: none"> <li>Fixed</li> </ul>	<ul style="list-style-type: none"> <li>Fixed</li> </ul>	<ul style="list-style-type: none"> <li>Open</li> </ul>
Authentication of conference participants	-	<ul style="list-style-type: none"> <li>Individual conference ID (optional)</li> <li>Password (optional)</li> </ul>	<ul style="list-style-type: none"> <li>Individual conference ID (optional)</li> <li>Password (optional)</li> </ul>	<ul style="list-style-type: none"> <li>Shared conference ID (optional)</li> </ul>
Recording, if enabled in the system	<ul style="list-style-type: none"> <li>Manually (On Demand Conference Recording)</li> </ul>	<ul style="list-style-type: none"> <li>Automatically (Auto Conference Recording)</li> <li>Manually (On Demand Conference Recording)</li> </ul>	<ul style="list-style-type: none"> <li>Automatically (Auto Conference Recording)</li> <li>Manually (On Demand Conference Recording)</li> </ul>	<ul style="list-style-type: none"> <li>Automatically (Auto Conference Recording)</li> <li>Manually (On Demand Conference Recording)</li> </ul>
Invitation by E-mail with:	<ul style="list-style-type: none"> <li>Conference Name</li> <li>Link for Web Collaboration session</li> </ul>	<ul style="list-style-type: none"> <li>Conference Name</li> <li>Dial-in number</li> <li>Conference ID</li> <li>Password</li> <li>Date and time of the start and end of the conference</li> <li>Link for Web Collaboration session</li> </ul>	<ul style="list-style-type: none"> <li>Conference Name</li> <li>Dial-in number</li> <li>Conference ID</li> <li>Password</li> <li>Link for Web Collaboration session</li> </ul>	<ul style="list-style-type: none"> <li>Conference Name</li> <li>Dial-in number</li> <li>Conference ID</li> <li>Password</li> </ul>
Outlook appointment as an e-mail attachment (.ics)	-	x	-	-

### **Application-controlled Conference**

As a subscriber, you can initiate, control and manage a conference with the Conference Management feature of myPortal for Desktop or myPortal for Outlook.

### **Phone-controlled Conference**

As a subscriber, you can initiate a phone-controlled conference and then control it via the phone by the following methods:

- Call the desired conference participant and connect him or her to the conference
- Extend a consultation call into a conference
- Extend a second call into a conference

### **Virtual conference room**

The virtual conference room enables you to follow a conference and its participants in a graphical environment (for application-controlled conferences) and to also manage the conference if you are the conference controller. The virtual conference room shows the phone number, name and presence status to the conference participants, where available.

### **Dial-in Number**

As an administrator, you can change the conference dial-in numbers that were set up during basic installation. As a subscriber, you can display the dial-in number for a conference.

### **Conference Controller**

The initiator of the conference is automatically the conference controller until this is explicitly changed. Depending on the type of conference, the controller can:

- Add or remove conference participants (for application-controlled conferences):  
Removed participants do not remain in the conference.
- Disconnect or reconnect conference participants:  
Disconnected participants remain in the conference. When the conference controller is connecting a conference participant, all other conference participants remain connected to one another. If there is only one participant connected, that participant will hear music on hold.
- Record a conference  
Recorded conferences are identified in the voicemail box with a red dot and show the call number of the first conference participant, if available. Conferences in which a participant is on hold cannot be recorded.
- Set another internal participant on the same node as the conference controller
- Extend the conference
- Leave the conference without ending it:  
The longest attending internal participant of the conference automatically becomes the conference controller.
- End the conference

### Conference Participants

Conference participants can leave the conference and optionally dial-into it again (scheduled and permanent conferences). As long as a conference has only one participant, the participant hears music on hold. As an administrator, you can specify whether multiple external conference participants are allowed. The maximum number of external conference participants is determined, among other things, by the number of available trunks.

### Conference tone

When connecting or disconnecting a conference participant, the other participants hear the conference tone. As an administrator, you can activate or deactivate the conference tone.

### Automatic Termination without a Conference Controller

If there are only external subscribers left in a conference, the participants will hear an alert tone after a specified time period. Following a further timeout, the conference is automatically terminated by the system. As an administrator, you can edit these time values.

### Notification by E-mail and Outlook Appointment

The system can automatically notify conference participants by e-mail and, for scheduled conferences, additionally through an Outlook appointment as an attachment (.ics):

Event	Notified conference participants	Outlook appointment
New conference	all	Automatic creation
Delete the conference		Automatic deletion
Reschedule the conference		Automatic update
Adding conference participants	Those affected	Automatic creation (those affected)
Remove conference participants		Automatic deletion (those affected)

This requires the administrator to have configured the sending of e-mails. In addition, an internal conference participant must have specified his or her e-mail address. For external conference participants, the initiator of the conference must enter their individual e-mail addresses.

---

**INFO:** For e-mail notifications, no return acknowledgments are obtained for failed deliveries or absence messages, since the e-mails are sent directly from the system due to the integration of Web Collaboration.

---

### Further Calls

While participating in a conference, making a call or accepting another call disconnects the participant from the conference.

### Park, Toggle/Connect

The Park and Toggle/Connect features are not available in a conference.

### Call Charges

Toll charges are assigned to the party who set up the toll call. When a conference is transferred to another conference controller, all further charges are assigned to that controller.

### System Load

As an administrator, you can display both active and saved conferences. Inactive conferences can be deleted.

---

**INFO:** Permanent conferences occupy system resources permanently. Since every subscriber can configure permanent conferences with myPortal for Desktop or myPortal for Outlook, you should, as the administrator, review the saved conferences regularly to avoid resource bottlenecks.

---

### Video Monitoring

Any ongoing video transmission must be terminated before participating in a conference.

## 12.7.1.1 How to Change the Dial-in Number for a Virtual Conference Room

### Prerequisites

- You are logged into the WBM with the **Expert** profile.

### Step by Step

- 1) In the navigation bar, click on **Expert Mode**.
- 2) Click on **Telephony > Stations** in the navigation tree.
- 3) Navigate in the menu tree to **Stations > UC Applications > Conference**.  
The call numbers of the virtual conference room is displayed in the work area. The last of these is the one for scheduled and permanent conferences.
- 4) In the menu tree, click on the relevant entry (Index - Call number).
- 5) Click on the **Edit Station Parameters** tab.
- 6) Enter the new dial-in number in the **Phone Number** field. The dial-in number may only include the digits 0-9.



- 7) Click on **Apply** followed by **OK**.

### 12.7.1.2 Allowing or Preventing Multiple External Conference Participants

#### *Prerequisites*

- You are logged into the WBM with the **Expert** profile.

#### *Step by Step*

- 1) In the navigation bar, click on **Expert Mode**.
- 2) Click **Telephony > Basic Settings** in the navigation tree.
- 3) Navigate in the menu tree to **System > System Flags**.
- 4) Select one of the following options:
  - If you want to allow multiple external conference participants, enable the check box **More than 1 external conference member**.
  - If you want to prevent multiple external conference participants, clear the check box **More than 1 external conference member**.
- 5) Click on **Apply** followed by **OK**.

### 12.7.1.3 How to Activate or Deactivate the Conference Tone

#### *Prerequisites*

- You are logged into the WBM with the **Expert** profile.

#### *Step by Step*

- 1) In the navigation bar, click on **Expert Mode**.
- 2) Click **Telephony > Basic Settings** in the navigation tree.
- 3) Navigate in the menu tree to **System > System Flags**.
- 4) Select one of the following options:
  - If you want to activate the conference tone, enable the **Conference tone** check box.
  - If you want to deactivate the conference tone, clear the **Conference tone** check box.
- 5) Click on **Apply** followed by **OK**.

## 12.7.1.4 How to Change the Time Interval for the Automatic Termination of a Conference

### *Prerequisites*

- You are logged into the WBM with the **Expert** profile.

### *Step by Step*

- 1) In the navigation bar, click on **Expert Mode**.
- 2) Click **Telephony > Basic Settings** in the navigation tree.
- 3) Navigate in the menu tree to **System > Time Parameters**.
- 4) In the **Time until warning tone in main station interface transit connections** row, under **Base** and **Factor**, select the desired time period between the time the last conference controller leaves the conference and the alert tone.
- 5) In the **Time from warning tone until release...** row, select the desired time from the alert tone till the automatic termination of the conference.
- 6) Click on **Apply** followed by **OK**.

## 12.7.1.5 How to Check the Details of a Saved Conference

### *Prerequisites*

- You are logged on to the WBM with the **Advanced** profile.

### *Step by Step*

- 1) In the navigation bar, click on **Setup**.
- 2) Click in the navigation tree on **Wizards > UC Suite**.
- 3) Click on **Edit** to start the **Conferencing** wizard.
- 4) Click on the relevant user conference.
- 5) Click on **Display**.

## 12.7.1.6 How to Delete a Saved Conference

### *Prerequisites*

- You are logged on to the WBM with the **Advanced** profile.

### *Step by Step*

- 1) In the navigation bar, click on **Setup**.
- 2) Click in the navigation tree on **Wizards > UC Suite**.
- 3) Click on **Edit** to start the **Conferencing** wizard.

- 4) Click on the relevant user conference.
- 5) Click on **Delete** and confirm the security prompt.

### 12.7.1.7 How to Configure the Recording of Conferences

#### *Prerequisites*

- You are logged into the WBM with the **Expert** profile.

#### *Step by Step*

- 1) In the navigation bar, click on **Expert Mode**.
- 2) In the navigation tree, click on **Applications > OpenScape Business UC Suite**.
- 3) Click on **Server**.
- 4) Click on **Record Call**.
- 5) If you want to allow the recording of calls and conferences, select the **Record Call** check box. The two check boxes described below can then be activated.
- 6) If you want an appropriate announcement to be played before the recording of calls and conferences, select the check box **Play prompt before recording**.
- 7) If you want to enable the playback of an alert tone during the recording of calls and conferences on OpenScape Business S, select the check box **Play pip tone during recording**.
- 8) Click on **Save**.

### 12.7.2 Ad-hoc Conference

An ad-hoc conference occurs spontaneously and is started manually by the conference controller. The conference controller can save ad-hoc conferences in order to set them up again at some later point in time.

#### **Starting the Conference**

The system opens the window with the virtual conference room automatically for all internal conference participants, provided they have started myPortal for Desktop with the classic user interface or myPortal for Outlook. The system calls all conference participants simultaneously. On joining the conference, each conference participant hears a greeting announcement with the name of the conference controller.

#### **Recording the Conference**

Conference controllers can record a conference manually for themselves or for all connected internal conference participants, provided the live recording of calls has been activated in the system. Participants located in the own node receive

the recording in the voicemail box; participants in other nodes, via email. The duration of the recording is only limited by the available storage capacity of the system.

### Ending the Conference

The conference controller can end the conference in the client or simply hang up. Alternatively, the conference ends when all conference participants have left the conference.

### Expanding a Call to a Conference

An internal subscriber who is conducting a call can convert the call to an ad-hoc conference and add further subscribers. For this, the subscriber must have a UC Suite Conference license. This feature is not available for CallMe.

## 12.7.3 Scheduled Conference

A scheduled conference (Meet-Me conference) occurs at a pre-defined point in the future with a defined duration and may be set up to recur repeatedly at the same time.

A scheduled conference will run for the entire scheduled duration even if there are no connected participants. The conference controller saves a scheduled conference under a specified name.

### Options for Configuring a Scheduled Conference

The initiator of the conference can define the following properties:

- Start time and End time
- Recurring conference
- Presence of conference controller required
- Authentication of conference participants on joining the conference required (by entering a conference ID and password via the phone keypad).

---

**INFO:** Mobility Entry users must enter the code for DTMF suffix dialing before their authentication.

---

The default password for conferences is 123456. The conference controller can change this for the conference participants individually.

- Language of announcements before the conference begins
- Direction for the connection setup for each conference participant (default: **outbound**).

### Starting the Conference

The system opens the window with the virtual conference room at the scheduled time automatically for all internal conference participants, provided they have started myPortal for Desktop with the classic user interface or myPortal for Outlook. If the presence of the conference controller is required, the

system first calls the controller. After the successful authentication of the controller, all the other conference participants are called simultaneously. Conference participants who have forwarded their calls to their voicemail boxes or who are determined to be absent by their presence status are not called. Depending on how the connection setup has been configured, the system calls the conference participants or the participants can dial in themselves. The system announces every participant who joins the conference by name, as in: ". . . has joined the conference", provided the initiator has recorded his or her name announcement.

---

**INFO:** Conference participants of a scheduled conference without authentication can only hear the announcement with the name of the conference controller at the start of the conference, provided they have already initiated a conference with authentication earlier on one occasion.

---

### Dialing In

Every conference participant can use the dial-in number to dial into the conference within the scheduled time period, regardless of which direction for the conference setup was set for that participant. Attempts to dial into the conference outside the scheduled time period result in a corresponding announcement. To dial in via an ITSP, the ITSP must support RFC 2833 (DTMF characters).

### Forcing Authentication with the Star (\*) Key

The conference controller can set the conference so that each conference participant is forced to provide authentication by at least by pressing the \* key. This ensures that only the participants who are actually present are connected to the conference, as opposed to a voicemail box, for example.

### Extending the Conference

Ten minutes before the scheduled end of the conference, the participants hear an announcement indicating that the conference is about to end and are offered the option of extending the conference by dialing a specific digit. Any conference participant can extend the conference by dialing that specific digit. The conference controller can extend the conference in myPortal for Outlook at any time.

### Recording the Conference

Conference controllers can record a conference automatically or manually for themselves or for all connected internal conference participants, provided the live recording of calls has been activated in the system. Participants located in the own node receive the recording in the voicemail box; participants in other nodes, via e-mail. The duration of the recording is only limited by the available storage capacity of the system.

### Ending the Conference

The conference ends at the time scheduled for the end of the conference or if the conference controller terminates the conference.

## 12.7.4 Permanent Conference

A permanent conference is not subject to time restrictions. The conference participants can dial in at any time.

The conference controller saves a permanent conference under a specified name. The conference is retained until it is explicitly deleted.

### Options for Configuring a Scheduled Conference

The initiator of the conference can specify:

- whether the conference participants need to authenticate themselves by entering a conference ID and password via the phone keypad when joining the conference.

---

**INFO:** Mobility Entry users must enter the code for DTMF suffix dialing before their authentication.

---

The default password for conferences is 123456. The conference controller can change this for the conference participants individually.

- in which language the announcements before the start of then conference are to be made.

### Starting the Conference

As soon as the first conference participant dials in, the system opens the window with the virtual conference room automatically for all internal conference participants, provided they have started myPortal for Desktop or myPortal for Outlook. All conference participants dial in themselves. The system announces every participant who joins the conference, as in: ". . . has joined the conference."

### Dialing In

Every conference participant can use the dial-in number to dial into the conference at any time. To dial in via an ITSP, the ITSP must support RFC 2833 (DTMF characters).

### Recording the Conference

Conference controllers can record a conference for themselves or for all connected internal conference participants, provided the live recording of calls has been activated in the system. Participants located in the own node receive the recording in the voicemail box; participants in other nodes, via e-mail. The duration of the recording is only limited by the available storage capacity of the system. Permanent conference cannot be automatically recorded.

## 12.7.5 Open Conference

Open conferences are intended for a fixed number of arbitrary participants. Any participant who has the requisite access data can dial into them.

The conference controller saves an open conference under a specified name. The conference is retained until it is explicitly deleted.

### Options for Configuring an Open Conference

The initiator of the conference can specify:

- The number of conference participants (max. 16).
- whether the conference participants need to authenticate themselves by entering a conference ID and password via the phone keypad when joining the conference.

---

**INFO:** Mobility Entry users must enter the code for DTMF suffix dialing before their authentication.

---

The default password for conferences is 123456. The conference controller can change this for the conference participants individually.

- what common conference ID is valid for all conference participants.
- in which language the announcements before the start of then conference are to be made.

### Starting the Conference

All conference participants dial in themselves. The system announces every internal participant who joins the conference, as in: "... has joined the conference."

### Dialing In

Every conference participant can use the dial-in number to dial into the conference at any time. To dial in via an ITSP, the ITSP must support RFC 2833 (DTMF characters).

### Recording the Conference

Conference controllers can record a conference automatically or manually for themselves or for all connected internal conference participants, provided the live recording of calls has been activated in the system. Participants located in the own node receive the recording in the voicemail box; participants in other nodes, via e-mail. The duration of the recording is only limited by the available storage capacity of the system.

## 12.8 Web Collaboration

The UC PC clients myPortal for Desktop (Windows) and myPortal for Outlook support the convenient integration of the separate product OpenScape Web

Collaboration for simultaneous multi-media collaboration during phone calls and conferences. This provides quick access to functions such as desktop and application sharing, file sharing, co-browsing, whiteboarding, URL push, IM chat and video chat with multiple participants.

Web collaboration can be started by a subscriber during a phone call via the pop-up window of the UC PC client or by the conference controller of an active conference from within the conference. This opens the web collaboration session. A local installation of Web Collaboration on the UC PC client is not required. If an email program is available on the UC PC client, an email with the link to the web collaboration client can be sent to the communication partners. Detailed information on web collaboration can be found in the Web Collaboration product documentation.

When creating or editing a conference, the conference controller can also schedule a web collaboration session. On deleting or ending a conference, the associated web collaboration session is automatically deleted as well.

---

**INFO:** In order to enable UC PC clients to start web collaboration automatically, proxy authentication must be disabled whenever the UC PC clients access the Internet via a proxy server.

---

### Supported Types of Connections

The web collaboration integration supports phone calls and phone-controlled conferences as well as the following types of application-controlled conferences:

- Ad-hoc conference
- Scheduled conference
- Permanent conference

### Integration of Web Collaboration

For the integration of Web Collaboration, the address of the Web Collaboration server must be known to the communication system. The vendor offers the web collaboration server as a service on the Internet (Public Server). Alternatively, it may also be possible to use a Custom Server located on the customer's own network or with a partner. If the server is on the customer's own network, it is usually addressed by the communication system on TCP port 5004 using http. In the case of a hosted solution on the Internet (Public Server), a secure https connection is used instead, since the license number and password are transmitted over this connection. By default, TCP port 5100 is used for this purpose.

---

**INFO:** In order to use web collaboration, the communication system requires an Internet connection (default router and DNS server). Connections via proxy are not supported.

---

Internal conference participants with UC PC clients are automatically connected to the appropriate web collaboration session on starting the conference. To do this, FastViewer is automatically downloaded and opened in the background,



which may take several seconds. External conference participants with known email addresses receive an email with an appropriate link to the Web Collaboration session.

---

**INFO:** Users working under a MAC OS must close the alert dialog for the terminated session manually after completion of a web collaboration session.

---

For a scheduled conference, it is possible to connect to the Web Collaboration session as early as 5 minutes before the start of the scheduled conference.

### Instant Messaging and Web Collaboration

Note that Instant Messaging of the system and Instant Messaging of a Web Collaboration session are mutually independent, i.e.: the instant messages from a UC PC client do not appear in a web collaboration session of the same participant, and vice versa.

## 12.8.1 How to Configure the Connection to the Web Collaboration Server (Custom Server)

### Prerequisites

- You are logged into the WBM with the **Expert** profile.
- Internet access is available.
- You need a license number and a password for the secure connection to the web collaboration server (custom server).

### Step by Step

- 1) In the navigation bar, click on **Expert Mode**.
- 2) In the navigation tree, click on **Applications > Web Services**.
- 3) Navigate in the menu tree down to **Web Services > Web Collaboration**.
- 4) Select the **Custom Server** radio button.
- 5) If you want to set up a secure connection to the web collaboration server (custom server), proceed as follows:
  - a) In the **URL / IP address** field, enter the address of the web collaboration server (custom server) in accordance with the following pattern:

```
https://<URL Web Collaboration Server>:5100/  
xmlrpcsecure
```

or

```
https://<IP-Adresse Web Collaboration Server>:5100/  
xmlrpcsecure
```

- b) Enter the license number for the secure connection to the web collaboration server (custom server) in the **Licence Number** field.
- c) Enter the password for the secure connection to the web collaboration server (custom server) in the **Password** field.
- 6) If you want to set up an unsecured connection to the web collaboration server (custom server), proceed as follows:
  - a) In the **URL / IP address** field, enter the address of the web collaboration server (custom server) in accordance with the following pattern:  

```
http://<URL Web Collaboration Server>:5004/  
OscInterface
```

or

```
http://<IP-Adresse Web Collaboration Server>:5004/  
OscInterface
```
- 7) Click on **Apply** followed by **OK**.

## 12.8.2 How to Configure the Connection to the Web Collaboration Server (Public Server)

### *Prerequisites*

- You are logged into the WBM with the **Expert** profile.
- Internet access is available.
- You need a license number and a password for the secure connection to the web collaboration server (public server).

### *Step by Step*

- 1) In the navigation bar, click on **Expert Mode**.
- 2) In the navigation tree, click on **Applications > Web Services**.
- 3) Navigate in the menu tree down to **Web Services > Web Collaboration**.
- 4) Select the **Public Server** radio button.
- 5) Enter the license number for the secure connection to the web collaboration server (public server) in the **Licence Number** field.
- 6) Enter the password for the secure connection to the web collaboration server (public server) in the **Password** field.

---

**INFO:** If you want to test the Web Collaboration for 5 minutes, you can select the radio button **Public Server (Demo Mode/Evaluation Mode)**. No license number and password are required for this purpose.

---

- 7) Click on **Apply** followed by **OK**.

## 12.8.3 How to Disable the Connection to the Web Collaboration Server

### *Prerequisites*

- You are logged into the WBM with the **Expert** profile.

### *Step by Step*

- 1) In the navigation bar, click on **Expert Mode**.
- 2) In the navigation tree, click on **Applications > Web Services**.
- 3) Navigate in the menu tree down to **Web Services > Web Collaboration**.
- 4) Select the radio button **No Web Collaboration Server**.
- 5) Click on **Apply** followed by **OK**. The option to start a web collaboration session is disabled in the UC client.

## 12.9 Instant Messaging

Instant Messaging refers to communicating with instant messages (usually called a chat).

### 12.9.1 Instant Messaging

Instant Messaging enables you to chat with other peers. The system supports instant messaging with users of UC Smart and external communication partners via XMPP and multi-user chats (or a combination of both).

Instant Messaging is possible with the following clients:

- myPortal for Desktop
- myPortal for Outlook
- myAgent
- myAttendant

As an administrator, you can enable or disable instant messaging on a system-wide basis. The sent and received instant messages are presented to the communication partners as an interactive dialog. On selecting a recipient, the client shows whether the communication partner is currently online. If one of the communication partners is offline, the following occurs with the instant message, depending on the type of the selected recipient:

Recipients	Behavior
Individual subscribers	The instant message is displayed at the next login.
Group in Favorites	The instant message is never displayed for the subscribers who are offline.

### External Instant Messaging

As a subscriber, you can also chat with *one* external XPP communication partner (e.g., a Google Talk user).

### Multi-user chat

A multi-user chat is the exchange of instant messages with multiple communication partners. Here too, the system supports a maximum of one external XMPP communication partner.

### Instant Messaging and Web Collaboration

Note that Instant Messaging of the system and Instant Messaging of a Web Collaboration session are mutually independent, i.e.: the instant messages from a UC client do not appear in a Web Collaboration session of the same participant, and vice versa.

## 12.9.1.1 How to Enable or Disable Instant Messaging

### Prerequisites

- You are logged into the WBM with the **Expert** profile.

### Step by Step

- 1) In the navigation bar, click on **Expert Mode**.
- 2) In the navigation tree, click on **Applications > OpenScape Business UC Suite**.
- 3) Click on **Server**.
- 4) Click on **General Settings**.
- 5) Select one of the following options:
  - If you want to enable system-wide instant messaging, clear the **Disable instant messaging** check box.
  - If you want to disable system-wide instant messaging, select the **Disable instant messaging** check box.

---

**INFO:** Disabling instant messaging has no effect on currently existing IM windows.

---

- 6) Click on **Save**.

## 12.10 AutoAttendant

Depending on the presence status of the called party, the AutoAttendant offers callers options to route voice calls to fixed numbers or their voicemail box. Callers signal their choice by entering digits at the phone.

### 12.10.1 Personal AutoAttendant

The personal AutoAttendant is the customized AutoAttendant, which can be configured by subscribers.

#### Personal AutoAttendant

As a subscriber, you can do the following for your station number with myPortal for Desktop or with myPortal for Outlook:

- Record or import announcements for the personal AutoAttendant.
- Configure profiles for the personal AutoAttendant

The relevant calls are first handled by the central AutoAttendant.

## 12.11 Voice and fax messages

The Voicemail and Fax services integrated in the system enable subscribers to receive and manage voicemails and fax messages via myPortal for Desktop and myPortal for Outlook. Fax messages can be sent by subscribers using Fax Printer.

### 12.11.1 Voicemail Box

The voicemail box records central voicemail and recorded calls. Subscribers can access it by phone and via UC Smart clients.

Only voice messages longer than two seconds are recorded.

#### Managing Voicemail Messages

As a subscriber, you can listen to your voicemails:

- via a PC with myPortal for Desktop or myPortal for Outlook

- via your phone if your Presence status is **Office** or **CallMe**
- via any external telephone

Using myAttendant, the Attendant can also listen to voicemails of other subscribers who have explicitly allowed this.

The subscriber uses folders such as Inbox, Played, Saved or Deleted to manage incoming voicemail messages.

Voice messages can also be played back, paused and forwarded to another subscriber. The subscriber can also save voicemail messages in .wav format and redirect them to any selected email account.

The voicemail box can also be used by subscribers to manage recorded calls. Recorded calls are identified in the voicemail box by an appropriate symbol.

---

**INFO:** Information on the Phone menu can be found in the Quick Reference Guide documentation of the UC Suite Telephone User Interface (TUI).

---

### **Calling Back the Sender of a Voice Message**

When listening to a voicemail, the subscriber can directly call back the person who left a message.

As an administrator, you can configure on a system-wide basis whether or not callbacks can be executed from the voicemail box

- from any phone number
- only from the own phone numbers of a subscriber configured under My Personal Details in the myPortal for Desktop, myPortal for Outlook, myAttendant and/or myAgent clients (**Extension, Mobile number, External Number 1, External Number 2, Private Number and Assistant Number**).

### **Retention Period**

As an administrator, you can configure the retention period for voice messages.

### **Prioritizing voicemail messages**

Callers can flag their voicemail messages as normal, urgent or private.

In myPortal for Desktop and myPortal for Outlook, the prioritization of existing voicemail messages is represented by different colors.

Subscribers who listen to their voicemail messages through the phone are first notified how many messages are urgent, private and normal. Urgent messages are played back first.

If the voicemail messages are forwarded as emails, the voicemails identified as urgent are flagged as emails with high priority.

### **Functionality of the Voicemail Box**

The administrator can define the scope of the voicemail box. He or she can choose between:

- **Full**  
Full functionality of the voicemail box (default value)
- **Short Menu**
- After the status-based or personal announcement is made, a connection to the operator is offered.
- **No Menu**
- After the greeting announcement is played, the caller is directly taken to record a message.

### Displaying New Messages at the Telephone

Voicemail messages are signaled at the telephone. As soon as the voicemail has been played, the indicators are deleted.

The type of signaling used for new voicemail messages depends on the phone

- For all telephones, acoustic signaling occurs using a special dial tone.
- For system telephones without a display, the Mailbox key also lights up (if configured).
- For system telephones with a display, the Mailbox key lights up (if configured), and a message appears on the display.

### Notification Service

Subscribers who are using myPortal for Desktop or myPortal for Outlook can define whether the notification about the arrival of new voicemails should be forwarded and, if so, to what destination.

Subscribers can also define whether the message should be forwarded as an email. In addition, they can choose to be notified about the arrival of new voicemails by a phone call or an SMS.

### Language of the Voicemail Box

As an administrator, you can select the default language of the voicemail box for the menu prompts and the internal system announcements on a system-wide basis.

### Dependencies

Topic	Dependency
Playing a message over the phone	Subscribers can play back voicemails through the phone only in the <b>Office</b> or <b>CallMe</b> presence status. For all other settings, the message can only be played back via the PC.

## 12.11.1.1 How to Configure Station Numbers for Voicemail

### Prerequisites

- You are logged on to the WBM with the **Advanced** profile.

### ***Step by Step***

- 1) Click on **Setup** in the navigation bar.
- 2) In the navigation tree, click **Wizards > Central Telephony**.
- 3) Click **Edit** to start the **Voicemail** wizard.
- 4) Enter the **VoiceMail Number**.
- 5) Click **OK & Next** followed by **Finish**.

## **12.11.1.2 How to Configure Call Forwarding to a Voicemail Box**

You can use the **Call Forwarding** wizard to configure call forwarding for a subscriber to his or her voicemail box.

### ***Prerequisites***

- You are logged on to the WBM with the **Advanced** profile.

### ***Step by Step***

- 1) In the navigation bar, click on **Setup**.
- 2) In the navigation tree, click **Wizards > User Telephony**.
- 3) Click **Edit** to start the **Call Forwarding** wizard. The **Configure the 'Call Forwarding - No Answer' feature** window appears.
- 4) Select the desired station in the **Select Station / Group** area.
- 5) Drag the **Voicemail box** with the mouse and drop it into the **Edit Call Forwarding** area.
- 6) If required, edit the time until call forwarding occurs (default: 15 seconds).
- 7) Click **OK & Next** followed by **Finish**.

## **12.11.1.3 How to Configure the Parameters of the Voicemail Box**

### ***Prerequisites***

- You are logged into the WBM with the **Expert** profile.

### ***Step by Step***

- 1) In the navigation bar, click on **Expert Mode**.
- 2) In the navigation tree, click on **Applications > OpenScape Business UC Suite**.
- 3) Click on **Server**.
- 4) Click on the **Voice Message** tab.



- 5) Select the language for the menu controls and the predefined announcements of your voicemail box in the **VoiceMail Language** drop-down list.
- 6) In the field **Voicemail Message Play Order**, specify in which order the messages should be played.
- 7) Enter the duration in seconds in the **Voicemail message recording time** field.
- 8) Specify the scope of the voicemail box in the **VoiceMail Mode** field.
- 9) If you want callbacks to be executed from the voicemail box only to the call numbers that are entered in the UC clients under **My Personal Details**, select the check box **Allow callback from VM to known number only**.
- 10) If you want to switch off the last announcement which is played from the system, select the check box **Skip "please leave a message after the tone" prompt**. The system announcement will not be heard even if a professional record announcement is used.
- 11) Click on **Save**.

#### 12.11.1.4 How to Configure Retention Periods for Voicemail

##### *Prerequisites*

- You are logged into the WBM with the **Expert** profile.

##### *Step by Step*

- 1) In the navigation bar, click on **Expert Mode**.
- 2) In the navigation tree, click on **Applications > OpenScope Business UC Suite**.
- 3) Click on **Server**.
- 4) Click on **Maintenance**.
- 5) Enter the respective retention periods in days in the fields under **Message**.
- 6) Click on **Save**.

#### 12.11.1.5 How to Activate or Deactivate the Password Prompt for the Voicemail Box

##### *Prerequisites*

- You are logged into the WBM with the **Expert** profile

##### *Step by Step*

- 1) In the navigation bar, click on **Expert Mode**.
- 2) In the navigation tree, click on **Applications > OpenScope Business UC Suite**.

- 3) Click on **User Directory**.
- 4) Click on **Sensitivity**.
- 5) Click on **Security and Access**.
- 6) Select one of the following options:
  - If you want to activate the password prompt on calling your voicemail box, clear the **Bypass password when calling voicemail** check box.
  - If you want to deactivate the password prompt on calling your voicemail box, enable the **Bypass password when calling voicemail** check box.
- 7) Click on **Save**.

### 12.11.1.6 How to Configure an Info for Received Voicemails

#### *Prerequisites*

- You are logged into the WBM with the **Expert** profile.

#### *Step by Step*

- 1) In the navigation bar, click on **Expert Mode**.
- 2) Click **Telephony Server > Basic Settings** in the navigation tree.
- 3) Click **System** in the menu tree.
- 4) Click **Display** in the menu tree.
- 5) Enable the **Status display for info message** check box in the **Switches** area.
- 6) Click **Apply** followed by **OK**.

### 12.11.1.7 How to Configure a Mailbox Key to Check Voicemail

#### *Prerequisites*

- You are logged on to the WBM with the **Advanced** profile.

#### *Step by Step*

- 1) In the navigation bar, click on **Setup**.
- 2) In the navigation tree, click **Wizards > Telephones / Subscribers**.
- 3) Click **Edit** to start the **Key Programming** wizard.
- 4) Select the relevant station.
- 5) Select the relevant key in the first column.
- 6) Select the **Mailbox** function in the **Key feature** column.
- 7) Click **Apply** followed by **OK**.

## 12.11.2 Voicemail Announcements

Voicemail announcements notify callers about the Presence status of a subscriber, for example.

Standard announcements are available in all languages. As a subscriber, you can also record or import personal announcements for your voicemail box. The corresponding standard announcement is overwritten by the personal announcement in the process. As an administrator, you can change the standard announcements by importing different announcements. The personal announcements of subscribers are overwritten in the process. The system performs the automatic level control and normalization needed to meet the "USA / TIA 968 Signal Power Limitations" requirements.

---

**INFO:** Before using announcements or music from other sources, make sure that you do not infringe on any copyrights.

---

### System Language for Voicemail Announcements

The system language for the voicemail box is set at the country initialization. In addition, the subscriber can set the language of his or her own voicemail box. A caller will then hear the station-specific announcements in the language set by the subscriber and the system-specific announcements in the system language.

### Announcements Depending on Presence Status and Profile

Depending on the Presence status, the announcements for the voicemail box change automatically; for example, if the Presence status is **Meeting**, then the announcement may be something like: The subscriber is in a meeting until 3.00 p.m. today. If the entered end of a meeting is reached, but the subscriber has not yet changed his or her status back to "In Office", then the voicemail announcement is adapted automatically or the voicemail announcement reverts automatically to "In Office" (this is configurable by the subscriber).

The following table describes which greeting is heard by the caller, depending on the set Presence status and profile. The caller menu refers to the central AutoAttendant. The profile refers to the personal AutoAttendant of the subscriber here. The default greeting, name and custom greeting for profiles must be recorded by the subscriber. Depending on the configuration, the caller menu may vary in length or may not be available at all.

	<b>Busy No answer Do Not Disturb</b>	<b>Meeting Sick Break Gone Out ...</b>
Voicemail with Presence status	Default greeting + Caller menu	Name + Presence status + Caller menu
Voicemail box with blocked Presence status	Default greeting + Caller menu (if enabled)	
Profile with dynamic greeting	Custom Profile Greeting	Name + Presence status + Custom Profile Greeting
Profiles if dynamic greeting is to be skipped	Custom Profile Greeting	

If a subscriber has set his or her presence status to not be displayed to external callers, the external caller will always receive the "Busy" greeting for all presence states other than "Office" even if the called subscriber may not be actually busy in some cases. In this case, the subscriber should set up an announcement for the "Busy" greeting to indicate that he or she cannot accept the call.

### 12.11.2.1 How to Import Announcements for the Voicemail Box

#### *Prerequisites*

- You are logged on to the WBM with the **Advanced** profile.
- The audio files to be loaded are available as PCM files with the following properties: 8 kHz, 16 bit, Mono. The maximum length for the audio file name is 30 characters.

---

**INFO:** You can use the Audio Wizard to create audio files in advance, while mixing two sources, e.g., background music and announcements.

---



---

**INFO:** Before using announcements or music, make sure that you do not infringe on any copyrights.

---

#### *Step by Step*

- 1) In the navigation bar, click on **Setup**.
- 2) Click in the navigation tree on **Wizards > UC Suite**.

- 3) Click on **Edit** to start the **File Upload** wizard.
- 4) On the **Audio File Manager** tab, select the entry **Voicemail Greeting** as the **Upload Destination**.
- 5) If you want to import an audio file, proceed as follows:
  - a) Click on **Browse** to select an appropriate audio file.
  - b) In the **Audio File Details** area, you will see the properties of the audio file such as the file name, file size, bit rate, etc.
  - c) Click **Upload**.
- 6) If you want to record an announcement using a phone, proceed as follows:
  - a) Under **Extension**, select the phone with which the announcement is to be recorded.
  - b) Click on **Make Call**. The selected phone rings.
  - c) Lift the telephone handset and click **Record**.
  - d) Speak into the handset to record your announcement and click **Finish** at the end.
  - e) You can then listen to your recording again with **Play**.

### 12.11.2.2 How to Change the Language for Voicemail Announcements

#### *Prerequisites*

- You are logged into the WBM with the **Expert** profile.

#### *Step by Step*

- 1) In the navigation bar, click on **Expert Mode**.
- 2) In the navigation tree, click on **Applications > OpenScape Business UC Suite**.
- 3) Click on **Server**.
- 4) Click on **Voicemail**.
- 5) Select the **VoiceMail Language** from the drop-down list.
- 6) Click on **Save**.

### 12.11.3 Fax Box

The fax box enables subscribers to receive and send fax messages via myPortal for Desktop or myPortal for Outlook without a fax machine.

As an administrator, you can configure a fax box for licensed subscribers. In addition, you can connect fax devices or fax servers via the a/b or ISDN interface.

As a subscriber, you can access your fax messages via myPortal for Desktop or myPortal for Outlook. myAttendant can access the fax messages of subscribers who have explicitly allowed this.

### Managing Fax Messages

The subscriber can manage received fax messages by moving them to different folders (Saved or Deleted, for instance). The fax messages can also be forwarded to another subscriber. The subscriber can also save fax messages as PDF or TIFF files and redirect them to any selected e-mail account.

The administrator can configure whether the fax message is to be stored as a TIFF file (default) or as a PDF file on a system-wide basis.

### Retention Period for Fax Messages

The system automatically deletes fax messages for which the following retention periods are exceeded:

Fax message	Retention period (days)
New	120
Read	365
Sent	365
Deleted	60

## 12.11.3.1 How to Add a Fax Box for Stations

### Prerequisites

- You are logged on to the WBM with the **Advanced** profile.

### Step by Step

- 1) In the navigation bar, click on **Setup**.
- 2) In the navigation tree, click on **Wizards > Telephones/Subscribers**.
- 3) Click on **Edit** to start the **IP Telephones** wizard.
- 4) Click in the **Fax No.** field of the subscriber and enter the fax number under which the subscriber can receive fax messages (the preset hyphen must be deleted).
- 5) If a direct inward dialing number is to be configured for the fax box, click the **Fax Direct Inward Dialing** field and enter the Fax DID number (the preset hyphen must be deleted).
- 6) Click on **OK & Next**. If required, you can to print out a list of subscribers with the configured fax call numbers using **Print**.
- 7) Click on **OK & Next** and then **Finish** to complete the wizard.

### 12.11.3.2 How to Configure the File Type for Stored Fax Messages (UC Suite)

#### Prerequisites

- You are logged into the WBM with the **Expert** profile.

#### Step by Step

- In the navigation bar, click on **Expert Mode**.
- In the navigation tree, click on **Applications > OpenScape Business UC Suite**.
- Click on **Server**.
- Click on **General Settings**.
- If you want to enable the saving of fax messages as PDF files, select the check box **Use PDF as fax format** in the **Fax Format** area.
- If you want to enable the saving of fax messages as TIFF files, clear the check box **Use PDF as fax format** in the **Fax Format** area.
- Click on **Save**.

### 12.11.4 Sending Fax Messages with Fax Printer

Fax Printer is an application for sending fax messages with centrally provided or individually created cover sheets from Windows applications such as Microsoft Word, for example.

Fax Printer consists of the following components:

- Fax Printer Cover Editor
- Fax Printer Driver

Fax Printer can be used from all the usual Windows programs. Fax groups make distribution easier. Fax messages are sent as an e-mail or directly to the Desktop. A screen pop notifies the subscriber when the fax is sent successfully.

#### Header Rows

As an administrator, you can configure different header lines for Fax Printer users. You can also define a header line as the default. Header lines may include the following elements:

Details	Placeholder
<b>Date / Time</b>	{{date_time}}
<b>Company Name</b>	{{company_name}}
<b>User name</b>	{{user_name}}

Details	Placeholder
Company Ph.	{{company_number}}
Page number	{{page_number}}
Number der pages	{{page_count}}

The header lines of fax messages sent with Fax Printer may only include characters from the ANSI character set. In other words, no special or diacritical characters such as umlauts are allowed. Since the header line may basically include the sender's name, no special or diacritical characters should appear in the names of the subscribers as well.

### 12.11.4.1 How to Add a Central Cover Page

#### *Prerequisites*

- You are logged on to the WBM with the **Advanced** profile.
- A fax cover page is available as a .opc file.

#### *Step by Step*

- 1) In the navigation bar, click on **Setup**.
- 2) Click in the navigation tree on **Wizards > UC Suite**.
- 3) Click on **Edit** to start the **File Upload** wizard.
- 4) Click on the **Central Fax Cover Page Upload** tab.
- 5) Click on **Browse**.
- 6) Select a .opc file.
- 7) Click on **Open**.
- 8) Under **File Name**, enter a name for the fax cover page.
- 9) Enter a **Description** for the fax cover page.
- 10) Click on **Upload**.
- 11) Click **OK** once the upload has been completed.
- 12) If you want to use this fax cover page as default, click on it in the list of fax cover pages and then click on **Set As Default**.
- 13) Click on **Save**.

### 12.11.4.2 How to Edit a Central Cover Page

#### *Prerequisites*

- You are logged on to the WBM with the **Advanced** profile.



### **Step by Step**

- 1) In the navigation bar, click on **Setup**.
- 2) Click in the navigation tree on **Wizards > UC Suite**.
- 3) Click on **Edit** to start the **File Upload** wizard.
- 4) Click on the **Central Fax Cover Page Upload** tab.
- 5) Click in the list of fax cover pages on the desired cover page.
- 6) Click on **Edit**.
- 7) Under **File Name**, enter a name for the fax cover page.
- 8) Enter a **Description** for the fax cover page.
- 9) Click on **Save**.

## **12.11.4.3 How to Add a Header Line for the Fax Printer**

### **Prerequisites**

- You are logged on to the WBM with the **Advanced** profile.

### **Step by Step**

- 1) In the navigation bar, click on **Setup**.
- 2) Click in the navigation tree on **Wizards > UC Suite**.
- 3) Click on **Edit** to start the **Fax Headlines** wizard.
- 4) Click on **Add**.
- 5) Enter the **Name** for the fax headline.
- 6) To add details to the header line, click on the **Date / Time**, **Company Name**, **User name**, **Company Ph.**, **Page number** and **Number der Pages** buttons in the desired sequence. For each detail, a corresponding placeholder appears in the **Text** field.
- 7) To remove a detail from the header line, select the appropriate placeholder in the **Text** field, e.g., `{{page_count}}` (**Number der Pages**) and press the **Del** key.
- 8) If required, enter any additional text in the **Text** field, e.g., "from" between the placeholders `{{page_number}}` (**Page number**) and `{{page_count}}` (**Page count**).
- 9) Click on **Save**.

## **12.11.4.4 How to Edit a Header Line for Fax Printer**

### **Prerequisites**

- You are logged on to the WBM with the **Advanced** profile.

### **Step by Step**

- 1) In the navigation bar, click on **Setup**.
- 2) In the navigation tree, click on **Applications > UC Suite**.
- 3) Click on **Fax Headlines**.
- 4) Click in the list of fax headlines on the desired headline.
- 5) Click on **Edit**.
- 6) Enter the **Name** for the fax headline.
- 7) To add details to the header line, click on the **Date / Time**, **Company Name**, **User name**, **Company Ph.**, **Page number** and **Number der Pages** buttons in the desired sequence. For each detail, a corresponding placeholder appears in the **Text** field.
- 8) To remove a detail from the header line, select the appropriate placeholder in the **Text** field, e.g., `{{page_count}}` (**Number der Pages**) and press the **Del** key.
- 9) If required, enter any additional text in the **Text** field, e.g., "from" between the placeholders `{{page_number}}` (**Page number**) and `{{page_count}}` (**Page count**).
- 10) Click on **Save**.

## **12.11.4.5 How to Delete a Header Line for Fax Printer**

### **Prerequisites**

- You are logged on to the WBM with the **Advanced** profile.

### **Step by Step**

- 1) In the navigation bar, click on **Setup**.
- 2) Click in the navigation tree on **Wizards > UC Suite**.
- 3) Click on **Edit** to start the **Fax Headlines** wizard.
- 4) Click in the list of fax headlines on the desired headline.
- 5) Click on **Remove**.

## **12.11.5 Notification Service for New Messages (UC Suite)**

The system can optionally notify you (as a subscriber) about a new message by e-mail, by phone or with an SMS.

The Notification Service works as follows:

Notification	for voicemail	for fax message	Prerequisites
E-mail	You receive an e-mail with the message as a WAV file, the date and time it was received, the duration of the message and, if available, the phone number and name of the sender. If the size of the WAV file exceeds 10 MB (average 1MB/min), it is not attached to the e-mail. Voicemails with "urgent" priority are flagged as e-mails with "High" importance. E-mails with a voicemail have a separate symbol in Outlook. If you are using an IMAP mailbox that shows only the e-mail headers, the usual e-mail icon will appear instead.	You receive an e-mail with the message as a PDF or TIFF file, the date and time it was received, the number of pages and, if available, the phone number and name of the sender. If the size of the PDF or TIFF file exceeds 10 MB, it is not attached to the e-mail. E-mails with a Fax message have a separate symbol in Outlook. If you are using an IMAP mailbox that shows only the e-mail headers, the usual e-mail icon will appear instead.	The delivery of e-mails has been configured in the system. The corresponding address is used as the sender.
SMS	You receive an SMS about the received message at the phone number defined by you.		The SMS template has been configured.
by phone	Your voicemail box calls you at the number you have specified and plays back the message to you.	-	

As a subscriber, you can enable or disable every type of notification for each Presence status individually. The notification by phone can be restricted to the business hours configured by the administrator. You can define the number and intervals for the repeated attempts for the notification by phone.

## 12.11.6 Sending E-mails

The feature for sending e-mails enables e-mail notifications about new voice and fax messages to be sent to subscribers and system messages to be sent to administrators by e-mail.

## 12.11.6.1 How to Configure the Sending of E-mails

### Prerequisites

- You are logged on to the WBM with the **Advanced** profile.
- An e-mail account with a password exists with an e-mail provider, and you know the access data for this account.

### Step by Step

- 1) Click on **Service Center** in the navigation bar.
- 2) Click **Service Center > E-mail Forwarding** in the navigation tree.
- 3) Enter the **Outgoing mail server (SMTP)** for the e-mail server to be used for sending e-mails, e.g., `smtp.web.de`. Ask your e-mail provider for the outgoing mail server if required.

---

**INFO:** In some cases, the sending of e-mails does not work because the name of the outgoing mail server cannot be resolved. To solve this problem, you must enter the IP address of the server instead of the name.

---

- 4) If a secure connection is required, enable the corresponding check box. If required, check with your e-mail provider whether this option needs to be enabled.
- 5) Enter the **User Name** of the e-mail account.
- 6) Enter the **Password** for the e-mail account and repeat it in the **Confirm Password** field.
- 7) Enter the **E-mail Address**, for example: `john.doe@web.de`.
- 8) If you want to now test the e-mail delivery, proceed as follows:
  - a) Click on **Test Connection**.
  - b) Under **Send to e-mail address**, enter the e-mail address of any e-mail box that you can access.
  - c) Enter the **Subject** in the e-mail.
  - d) Click on **Send Test E-mail**.
  - e) Check whether you have received the e-mail.
  - f) If the e-mail delivery failed, click **Back** and correct your e-mail settings (starting with step 3).
- 9) Enter the **E-mail Address 1** to get a notification email when ALL tolerance has been used. You may also enter a second email address.
- 10) Click on **OK & Next** followed by **Finish**.

## 12.11.7 SMS Template

An SMS template enables subscribers to be notified about new voicemails with an SMS.

In order to receive SMS messages, a personal mobile e-mail address of the respective provider must be first activated. To do this, the subscriber sends an activation SMS to a speed-dial number. The subscriber then receives an SMS with his or her personal e-mail address, which is usually composed of the call number and the gateway name. For example, the mobile e-mail address for a T-Mobile customer with the phone number 0171/1234 567 would be: 01711234567@t-mobile-sms.de. This applies analogously to other networks as well.

An SMS template consists of the Template Details and SMS Details areas. The administrator must enter the name of the template in the Template Details area. This is usually the name of the E-mail-to-SMS Provider.

The specifications in the SMS Details area depend on the Provider. Under Recipient, the administrator must enter the e-mail address to which the SMS is to be sent. The entry for the Subject line may be freely selectable or require the customer number to be entered by the administrator.

---

**INFO:** Every Provider requires a specific template. The required data can be obtained from the respective mobile service provider.

---

### Placeholder

SMS templates may include the following placeholders in the **Recipient**, **Subject** or **Text** field:

Details	Placeholder
Mobile number to which the message is to be sent	{{MobileNumber}}
Name or call no. of the sender	{{Sender}}
Date and time of receiving a message	{{DateTime}}
Caller number	{{CallingNumber}}
Priority of message	{{Priority}}

### System-Specific Information

The length of the message is reduced to the first 160 characters.

### 12.11.7.1 How to Add an SMS Template

#### Prerequisites

- You are logged on to the WBM with the **Advanced** profile.

### **Step by Step**

- 1) In the navigation bar, click on **Setup**.
- 2) Click in the navigation tree on **Wizards > UC Suite**.
- 3) Click on **Edit** to start the **Templates** wizard.
- 4) Click on **Create**.
- 5) Enter the **Template Name**.
- 6) Enter the name of the author under **Author Name**.
- 7) If you want to insert a placeholder, proceed in the following steps:
  - a) Click in the field in which you want to insert the placeholder: **Recipients**, **Subject** or **Text**.
  - b) Select the desired placeholder in the **VSL Fields** drop-down list.
  - c) Click on **Paste**.
  - d) If you want to insert additional placeholders, repeat step 7 a-c accordingly.
- 8) Enter the **Recipient**.
- 9) Enter the **Subject**.
- 10) Enter the **Text**.
- 11) Click on **Create**.

## **12.11.7.2 How to Edit an SMS Template**

### **Prerequisites**

- You are logged on to the WBM with the **Advanced** profile.

### **Step by Step**

- 1) In the navigation bar, click on **Setup**.
- 2) Click in the navigation tree on **Wizards > UC Suite**.
- 3) Click on **Edit** to start the **Templates** wizard.
- 4) Select the desired SMS template in the **SMS Templates** drop-down list.
- 5) Click on **Edit**.
- 6) Enter the **Template Name**.
- 7) Enter the name of the author under **Author Name**.
- 8) If you want to insert a placeholder, proceed in the following steps:
  - a) Click in the field in which you want to insert the placeholder: **Recipients**, **Subject** or **Text**.
  - b) Select the desired placeholder in the **VSL Fields** drop-down list.
  - c) Click on **Paste**.

- d) If you want to insert additional placeholders, repeat step 8 a-c accordingly.
- 9) Enter the **Recipient**.
- 10) Enter the **Subject**.
- 11) Enter the **Text**.
- 12) Click on **Create**.

### 12.11.7.3 How to Remove an SMS Template

#### *Prerequisites*

- You are logged on to the WBM with the **Advanced** profile.

#### *Step by Step*

- 1) In the navigation bar, click on **Setup**.
- 2) Click in the navigation tree on **Wizards > UC Suite**.
- 3) Click on **Edit** to start the **Templates** wizard.
- 4) Select the desired SMS template in the **SMS Templates** drop-down list.
- 5) Click on **Remove**.

### 12.11.8 Fax over IP (T.38 / G.711 Fax)

Fax over IP enables the transmission of fax messages over the Internet in accordance with the G2 and G3 standards by using the network protocol IFP (Internet Facsimile Protocol).

UC Suite can generally handle up to 8 simultaneous fax connections. Depending on the DSP module, OpenScape Business X3/X5/X8 as an ISDN gateway can handle from 3 to 12 concurrent faxes. Both parameters determine the number of simultaneous T.38 or G.711 fax connections.

---

**INFO:** It is highly recommended to use T.38 fax, if possible.

---

The system supports the following scenarios for T.38 or G.711:

- A subscriber receives fax messages via an ITSP (Internet Telephony Service Provider) at his or her fax box and sends faxes to external locations with Fax Printer via the ITSP.
- A subscriber receives fax messages via a Mediatrix 4102S (SIP) at his or her fax box and sends faxes with Fax Printer via a Mediatrix 4102S (SIP).
- Stations can receive Fax messages via an ITSP (Internet Telephony Service Provider) on a fax device that is directly connected to an analog or ISDN interface and send faxes from this fax device via the ITSP to external destinations.

- Stations can receive fax messages via an ITSP on a fax device that is connected to a Mediatrix 4102S and send faxes from this fax device via the Mediatrix 4102S and ITSP to external destinations.
- Stations can receive fax messages via ISDN on a fax device that is connected to a Mediatrix 4102S and send faxes from this fax device via the Mediatrix 4102S and ISDN to external destinations.
- A station can send fax messages from a fax device that is connected to a Mediatrix 4102S to another fax device that is also connected to a Mediatrix 4102S.
- Internal fax message from a fax device at an ISDN port to a fax device at a Mediatrix 4102S and vice versa.
- Internal fax message from a fax device at an ISDN port to a fax box and vice versa.

---

**INFO:** T.38 must be activated in the system for the fax box. In order to send faxes from the communication system via an ITSP, the ITSP must support T.38. In case the ITSP cannot switch to T.38, then the fax will be handled as G.711.

---

### 12.11.8.1 How Enable or Disable Fax over IP (T.38 Fax)

#### *Prerequisites*

- You are logged into the WBM with the **Expert** profile.

#### *Step by Step*

- 1) In the navigation bar, click on **Expert Mode**.
- 2) In the navigation tree, click **Telephony Server > Voice Gateway**.
- 3) Click on **Voice Gateway** in the menu tree.
- 4) In the menu tree, click **Codec Parameters**.
- 5) Select one of the following options in the **T.38 Fax** area:
  - If you want to enable Fax over IP (T.38 Fax), select the **T.38 Fax** check box.
  - If you want to disable Fax over IP (T.38 Fax), clear the **T.38 Fax** check box.
- 6) Click on **Apply** followed by **OK**.



## 13 Functions at the Telephone

The communication system offers a comprehensive set of telephony features extending from the usual features such as hold, toggle/connect and consultation hold, etc., through various call signaling mechanisms, down to call transfers, call deflections and call forwarding.

### 13.1 Making Call

The communication system offers many ways to make calls, including, among other things, direct station selection and speed dialing.

#### 13.1.1 Digit Dialing

In the case of digit dialing, every digit is transmitted as soon as it is dialed.

The call setup begins immediately after the input of the first digit. Consequently, the subscriber has no way to edit the dialed number.

#### 13.1.2 En-Bloc Dialing

In en-bloc dialing, connections are only established after the complete phone number has been entered. The call number is transferred as a single block.

The transmission of the dialed number can be initiated by entering the end-of-dialing code (#).

En-bloc dialing is mandatory for:

- ITSP trunk connection
- ISDN Primary Rate Interface in the U.S.

After 5 seconds without the input of a digit, the last entered digit is interpreted as the final digit of the number block.

#### 13.1.3 Keypad dial

In some countries, the services of digital trunk connections are controlled using keypad dialing instead of functional control. To activate these services in the PSTN, you can use the stimulus interface.

The feature must be configured in E Manager.

Subscribers acknowledge the message traffic using the display. As a result, keypad dialing can only be performed on telephones with a display (optiPoint, OpenStage), mobile telephones (Cordless) with optiPoint menu navigation and IP telephones with stimulus interfaces. ISDN telephones are not supported. Each network provider determines which services can be used with keypad dialing.

An authorized station can activate keypad dialing using the service menu or using the \*503 code. This is possible only in the idle state. Then the station must select an ISDN trunk that the feature can use.

Depending on the messages sent by the central office (such as when connecting), keypad dialing can create CDR entries. The number of the station using keypad dialing, the line used, and the time period when the feature was used are logged.

---

**INFO:** Actions triggered by keypad dialing are not monitored by the system. The system cannot prevent improper use, such as call charges fraud or trunk blocking.

Customers must be informed that they are liable for damages resulting from the improper use of this feature.

---

### 13.1.4 End-of-Dialing Recognition

End-of-dialing is either recognized automatically after five seconds or indicated manually by the user with the end-of-dialing code "#".

### 13.1.5 Editing the Telephone Number

This option lets subscribers modify the digits entered for the station number. This function is common in mobile phones. A call number can only be corrected as it is being entered.

After entering a sequence of digits, the user can edit it from right to left by pressing a key; each time the key is pressed, one digit is deleted. Once the correct digit sequence is entered in full, the user can press the confirm key or lift the handset to start digit transmission.

It is not possible to edit a saved call number, for example, for number redial.

---

**INFO:** This feature can be individually activated for every station.

---

## Dependencies

Topic	Dependency
Call waiting	Call waiting is possible during editing because the telephone is in digit input state and is busy for incoming traffic.
Consultation	The telephone is in digit input state after a consultation. This makes it possible to edit station number digits.

### 13.1.5.1 How to Activate or Deactivate Editing of the Telephone Number

#### *Prerequisites*

- You are logged into the WBM with the **Expert** profile.

#### *Step by Step*

- 1) In the navigation bar, click on **Expert Mode**.
- 2) In the navigation tree, click on **Telephony > Stations**.
- 3) In the menu tree, click **Stations**.
- 4) In the menu tree, click the station (Index - Call number - Name).
- 5) Click on the **Edit Station Flags** tab.
- 6) Select one of the following options:
  - If you want to activate the function, select the check box **Edit tel. number**.
  - If you want to deactivate the function, clear the check box **Edit tel. number**.
- 7) Click on **Apply** followed by **OK**.

### 13.1.6 Redialing

The phone number dialed is saved after an external call is set up. If the destination is busy or not reachable, a user can press the Redial key to redial the same number.

Speed dial numbers are also stored in the redial memory.

Dialing internal call numbers has no effect on the redial memory.

Post-dialed digits (also called DTMF characters), if any, are not seen as part of the dialing information and are therefore not saved (e.g., digits sent to a connected voicemail box).

The Redial function can only be activated via a key, not via an access code.

To retrieve a specific number and use it to set up another call, press the Redial key. Press the key once to dial the last number dialed. Press the key twice to dial

the next-to-the-last number dialed. Press the key three times to dial the number that was stored the longest.

The station number saved is automatically dialed after 2 seconds when you press the Redial key. If you need more time to read the displayed station number, select "scroll" with the Confirm Key. Click "Next" to display the next phone number saved. This phone number is dialed only on selecting the "Make Call" command. This gives you much more time to check if the correct phone number was selected.

In the case of a call routed via LCR, only the number dialed by the station is stored.

Account codes are also stored in the redial memory. This is true only if the appropriate system-wide flags are set.

### 13.1.6.1 How to Enable or Disable Automatic Redialing

#### *Prerequisites*

- You are logged into the WBM with the **Expert** profile.

#### *Step by Step*

- 1) In the navigation bar, click on **Expert Mode**.
- 2) Click **Telephony > Basic Settings** in the navigation tree.
- 3) Click **System** in the menu tree.
- 4) Click on **System Flags**.
- 5) Select one of the following options:
  - If you want to activate the function, select the check box **Automatic redial**.
  - If you want to deactivate the function, clear the check box **Automatic redial**.
- 6) Click on **Apply** followed by **OK**.

### 13.1.7 System Speed Dialing

You can save frequently needed external phone numbers in the communication system. Every number is then represented by a speed-dial number which is used instead of the full phone number.

Speed-dial numbers consist of 4-digit numbers.

All subscribers are members by default of a group that is assigned all SSD numbers. This means that every subscriber can use all SSD numbers.

SSD overrides toll restriction rules.

The numbers for system speed dialing are configured by the administrator in groups. The subscribers can each be assigned to one of these groups. A subscriber can only use the speed-dial numbers of his or her allocated group. A group can only be assigned a single SSD range.

Entries in speed dials are searchable by first and last name if name is configured in <Last Name>, <First Name> or <First Name>, <Last Name> format.

Used speed dial numbers are stored in the redial memory.

To program a "dial pause" and DTMF changeover for suffix dialing of DTMF characters (e.g., for controlling voicemail boxes), you can use the Repdial "P-key" or "#" (pound) key.

### Translation of station numbers to names

You can assign a name to each speed-dialing destination. As soon as a call is received from a saved phone number, the system automatically enters the name and displays it instead of the phone number if CLIP is set.

### Suffix-dialing

Suffix-dialing is also possible:

- Manual suffix-dialing  
The user can select additional numbers by selecting the access code and entering the index number (speed-dial number). These are added to the station number saved in this index and dialed.
- Automatic suffix-dialing  
When configuring an SSD, the number entered can be split into two parts. A dash "-" is used as the separator. The first part is always sent. A timer then starts. If the user does not dial any more digits before the timer expires, the second part of the number entered is automatically suffix-dialed, otherwise the manually dialed digits are transmitted.

For example: SSD = 7007-0

If the station does dial a DID (manual suffix-dialing) after selecting the SSD and before the specified time has expired, 0 is automatically dialed (automatic suffix-dialing).

### Importing Speed Dial Numbers

You can import speed-dial lists from an XML or CSV file in UTF-8 format. Existing speed dial numbers are deleted before the import.

File structure:

4-digit speed dial (use leading zeros);CO access code with long number ; last name, first name

Example:

```
0001;08970070;Schmidt, Marcus
```

```
1010;006768970070;Schmoll, Lucas
```

---

**INFO:** An XML template with the appropriate explanations can be found in the WBM under **Service Center > Documents > CSV Templates**. You can enter your speed dial destinations in these templates by using Microsoft Excel, for example.

---

### Exporting Speed Dial Numbers

As an administrator with the **Expert** profile, you can export speed-dial numbers to an XML file in UTF-8 format in the **Expert mode**. The export always includes all the records.

## 13.1.7.1 How to Add a Speed Dial

The **Phone Book/Speed Dialing** wizard can be used to add speed-dial destinations for system speed dialing.

### *Prerequisites*

- You are logged in at the WBM.

### *Step by Step*

- 1) In the navigation bar, click on **Setup**.
- 2) In the navigation tree, click **Wizards > Central Telephony**.
- 3) Click on **Edit** to start the **Phone Book/Speed Dialing** wizard.
- 4) Enter the **Speed dial** number, the **Call number**, and the **Name** of the speed-dial destination in a free table row.
- 5) If you want to add further speed-dial destinations, click on **Store data** and repeat the previous step.
- 6) Click on **OK & Next**.
- 7) Click on **Finish**.

## 13.1.7.2 How to Import Speed Dials from an XML or CSV File

The **Phone Book / Speed Dialing** wizard can be used to import speed-dial numbers and phone numbers from an XML or CSV file. Existing speed dial numbers are deleted before the import.

### *Prerequisites*

- You are logged in at the WBM.
- An XML file or a CSV file with the entered speed dial numbers is available in UTF-8 format. An XML and a CSV template for importing speed-dial numbers can be found under **Service Center > Documents > CSV Templates**.

### *Step by Step*

- 1) In the navigation bar, click on **Setup**.
- 2) In the navigation tree, click on **Wizards > Central Telephony**.
- 3) Click on **Edit** to start the **Phone Book/Speed Dialing** wizard. The **Edit central phone book** window appears.
- 4) Click on **Import/Export CSV/XML Data**.
- 5) Click in the **Import CSV/XML file via HTTP** area on **Browse** to select the desired file.
- 6) Click on **OK**. Existing speed dial numbers are deleted, and the speed dial numbers entered in the XML or CSV file are imported into the system.
- 7) Click on **Finish**.

### 13.1.7.3 How to Export Speed Dials to an XML File

You can export speed dial numbers to an XML file. The export always includes all the data.

#### *Prerequisites*

- You are logged in at the WBM.

### *Step by Step*

- 1) In the navigation bar, click on **Setup**.
- 2) In the navigation tree, click on **Wizards > Central Telephony**.
- 3) Click on **Edit** to start the **Phone Book/Speed Dialing** wizard. The **Edit central phone book** window appears.
- 4) Click on **Import/Export CSV/XML Data**.
- 5) Click in the **Export XML file via HTTP** area on **Download**. The list of speed dial numbers is prepared for downloading.
- 6) Select the storage location for the file and click **Save**.

### 13.1.7.4 How to Edit Speed Dials

The **Phone Book/Speed Dialing** wizard can be used to edit speed-dial destinations.

#### *Prerequisites*

- You are logged in at the WBM.

### Step by Step

- 1) In the navigation bar, click on **Setup**.
- 2) In the navigation tree, click on **Wizards > Central Telephony**.
- 3) Click **Edit** to start the **Phone Book/Speed Dialing** wizard.
- 4) You can search for an entry by typing a search term in the **Speed dial, Call number** or **Name** search fields and then pressing the return key. All matches that contain the search term are displayed. For example, entering the call number 521 would display the matches +495213535 and +498967521, and entering the term co as the name would display Collins, Mcoin and Branco.

---

**INFO:** Pressing the return key with nothing entered in any of the search fields causes all entries to be displayed.

---

- 5) Edit the values for the desired table entry in the **Speed dial, Call number** or **Name** fields.
- 6) If you want to edit additional speed-dial destinations, click on **Store data** and repeat the previous step.
- 7) Click **OK & Next**.
- 8) Click **Finish**.

## 13.1.8 Individual Speed Dialing (ISD)

Individual Speed Dialing (ISD) enables every subscriber to save 10 external numbers as individual speed-dial numbers in addition to the system speed-dial numbers.

For telephones without a display, the station user must wait for the confirmation tone following station number entry.

External numbers can be programmed in the ISD pool. Access depends on the station's dial-up access rights. Before entering the station number, the subscriber must enter the CO access code (e.g., 0).

The Redial key or the pound (#) key is used to program a dial pause or DTMF changeover.

## 13.1.9 Direct station select

The function keys on a telephone or add-on device can be programmed as DSS keys. These are programmed with the phone number of an internal subscriber or a group for this. Press a key of this kind to initiate an immediate call to the programmed destination (DSS). The current status of the subscriber or of the group is indicated by the LED associated with the DSS key.



A DSS (direct station selection) key can also be used to transfer a call quickly to the programmed subscriber or group. Pressing a DSS key during a call with an external party places the ongoing call on consultation hold. The transferring subscriber can transfer the call to the transfer destination by replacing the handset (unscreened transfer). He or she can also wait until the transfer destination responds before transferring the call (screened transfer). If the transfer destination does not answer, an automatic recall is enabled.

### Statues of a DSS Key LED

The DSS key LED shows the current status of the programmed station:

- Off: the associated subscriber is not conducting a call.
- Lit: the associated subscriber is conducting a call or has activated Do Not Disturb.
- Flashing fast: the associated subscriber is conducting a call. The call can be accepted by pressing the Direct Station Select (DSS) key.
- Flashing slowly: the associated subscriber is being called and has not yet answered. The call can be accepted by pressing the Direct Station Select (DSS) key.

### Dependencies

Topic	Dependency
ISDN phones, SIP phones	Direct Station Select (DSS) keys cannot be programmed for ISDN or SIP telephones.

## 13.1.10 Speaker Calls / Direct Answering

The Speaker call function lets you set up an internal connection without the called subscriber lifting the handset. The loudspeaker on the called station is automatically activated.

On phones equipped with a speakerphone (microphone), direct answering of the called station is possible by switching on the microphone. On lifting the handset, the call becomes a normal two-party call.

Speaker calls can be used via a function key programmed for this purpose, the associated menu item or by entering the code and then dialing the station number of the destination station or group. A function key can also be programmed with a station number. A connection to the programmed destination is immediately set up when you press a function key of this kind.

Speaker calls also enable the broadcasting of announcements to all internal members of a group.

Direct answering can be activated via the menu item provided for this in the display or via a function key programmed for this purpose.

Speaker calls can be prevented for a subscriber by enabling an option to prevent voice calling. In this case, speaker calls are signaled like a normal call.

### Dependencies

Topic	Dependency
Do Not Disturb, Override Do Not Disturb	Speaker calls are not possible at stations where Do Not Disturb is active. If the subscriber who wants to use the "Speaker calls" feature is authorized to override Do Not Disturb, he or she hears the busy tone for five seconds. The destination station is then called, but not directly addressed.
Toggle, consultation hold, transfer	The specified features cannot be used in a speaker calls/ direct answering connection.
ISDN phones, SIP phones	The "Speaker call" and "Direct answering" features cannot be used with ISDN or SIP telephones.

### 13.1.10.1 How to Enable or Disable the Prevention of Speaker Calls for Stations

#### *Prerequisites*

- You are logged into the WBM with the **Expert** profile.

#### *Step by Step*

- 1) In the navigation bar, click on **Expert Mode**.
- 2) In the navigation tree, click on **Telephony > Stations**.
- 3) Navigate in the menu tree under **Stations > Station > ...** down to the desired station (Index - Station Number - Name).
- 4) Click on the **Edit Station Flags** tab.
- 5) Select one of the following options:
  - If you want to enable the prevention of speaker calls for stations, clear the check box **Prevention of voice calling off**.
  - If you want to disable the prevention of speaker calls for stations, select the check box **Prevention of voice calling off**.
- 6) Click on **Apply** followed by **OK**.

### 13.1.11 Associated Dialing

Associated dialing enables an authorized subscriber to dial a phone number on behalf of any other subscriber. The effect is the same as when the other subscriber dials the phone number.

The user accesses the function by dialing a code and specifying the station for which a number should be dialed. The system then interprets this information as though the station specified earlier were dialing.

## 13.1.12 Trunk Queuing

A subscriber can reserve a trunk in advance if there are no free trunks available (busy signal). As soon as a trunk becomes free, it is offered to the subscriber through an automatic recall.

If the user is busy at the time of the recall, the trunk will camp on to the busy station. If the camp-on tone is not answered, the reservation is canceled, and the trunk is offered to the next station in the queue. If the user activated DND prior to receiving the recall from the queued trunk, the trunk reservation is canceled and the trunk is offered to the next station in the queue.

If a number of stations queue a trunk, the trunk is assigned in the order that the requests were received.

Only one queue/reservation request is accepted per telephone. If a second reservation is attempted, it overwrites the first.

It is not possible to invoke the Trunk Queuing feature if the attempted call was placed through LCR (least cost routing).

The Trunk Queuing feature ignores an existing call forwarding—no answer instruction. Trunk reservation is canceled if not answered within 20 seconds.

A recalling trunk cannot be picked up by either Call Pick up - group or Call pick up - Directed.

Trunks can be reserved in one of the following ways:

- Manual reservations only work in telephones with a display
- Automatic reservation (for all other telephones)

When this flag is activated and if a station is not assigned a free trunk after the usual simplified dialing procedures, the busy tone is signaled at the station. After five seconds, a positive acknowledgment tone is applied and the trunk is reserved, provided that the station has the appropriate CO call privilege.

---

**INFO:** Trunk queuing is not possible for S<sub>0</sub> phones.

---

### 13.1.12.1 How to Activate or Deactivate Trunk Queuing

#### *Prerequisites*

- You are logged into the WBM with the **Expert** profile.

#### *Step by Step*

- 1) In the navigation bar, click on **Expert Mode**.
- 2) Click **Telephony > Basic Settings** in the navigation tree.

- 3) Click **System** in the menu tree.
- 4) Click on **System Flags**.
- 5) Select one of the following options:
  - If you want to activate the function, select the check box **Trunk reservation, automatic**.
  - If you want to deactivate the function, clear the check box **Trunk reservation, automatic**.
- 6) Click on **Apply** followed by **OK**.

### 13.1.13 Private Trunk

A private trunk is a CO trunk that is available exclusively to a specific subscriber.

## 13.2 Call Signaling, Calling Line ID

The communication system offers various options for call signaling and call number display such as CLIP, CLIR, COLP and COLR, for example.

### 13.2.1 Different Call Signaling

Different call signaling enables a distinction to be made between internal and external incoming calls.

Incoming calls are signaled visually and acoustically on the phone. The following displays appear on the screen:

- Caller number
- For internal call forwarding: additionally, the dialed call number

The incoming call can also be signaled via an LED. Different acoustic signals are used for internal and external calls.

#### **Call signaling internal**

Each subscriber can be assigned one of a total of eight possible acoustic call signals for internal calls. The station then uses the modified ringing tone to distinguish its calls at other internal stations. For example, a special internal ringing tone can be set for the manager so that every staff member knows when the manager is calling simply from the ringing tone.

#### **Call signaling external**

There are three different call types, each with different acoustics, that can be set for an external call. Different acoustic signals can be applied, for instance, to

distinguish between calls from two different groups such as Sales and Warehouse.

- In Germany, the administrator can configure three different ring types for analog, ISDN and system phones.
- In other countries, the ring types for analog phones are the same.

## 13.2.2 Calling Line Identification Presentation (CLIP)

Calling Line Identification Presentation (CLIP) shows the caller's number at the called station.

The CLIP (Calling Line Identification Presentation) refers to incoming calls and must be supported by the network provider.

If the caller's name and phone number are programmed as a system speed dialing (SSD) number in the communication system, you will see the name on your display.

The Calling Line Identification Presentation (CLIP) and Calling Line Identification Restriction (CLIR) features are mutually exclusive, that is, as soon as CLIP is activated, CLIR is deactivated, and vice versa.

### Configurable CLIP

Configurable CLIP transmits a set call number (e.g., the call number of a hunt group) externally instead of the caller's number (e.g., the number of the hunt group member).

### System-Specific Information

Country	Enabled by default
USA	LIN (Location Identification Number). If CLIP is enabled for the USA, LIN is automatically disabled.
Remaining countries	CLIP

### 13.2.2.1 How to Enable or Disable Configurable CLIP

#### Prerequisites

- You are logged into the WBM with the **Expert** profile.

#### Step by Step

- 1) In the navigation bar, click on **Expert Mode**.
- 2) Click **Telephony > Basic Settings** in the navigation tree.
- 3) Click **System** in the menu tree.
- 4) Click on **System Flags**.

- 5) Select one of the following options:
  - If you want to enable Configurable CLIP, select the **Configurable CLIP** check box.
  - If you want to disable Configurable CLIP, clear the **Configurable CLIP** check box.
- 6) Click on **Apply** followed by **OK**.

### 13.2.3 Calling Line Identification Restriction (CLIR)

Calling Line Identification Restriction (CLIR) suppresses the station number of the caller at the station of the called subscriber.

CLIR (Calling Line Identification Restriction) applies to outbound calls. The PSTN must support the feature. The Calling Line Identification Restriction (CLIR) has precedence over the Calling Line Identification Presentation (CLIP).

The Calling Line Identification Presentation (CLIP) and Calling Line Identification Restriction (CLIR) features are mutually exclusive, that is, as soon as CLIP is activated, CLIR is deactivated, and vice versa.

CLIR and COLR can only be enabled or disabled together.

Calling Line Identification Restriction (CLIR) has no effect for certain call destinations (e.g., emergency numbers of the police and fire departments).

#### **System-wide Station Number Suppression (CLIR)**

As an administrator you can enable or disable the CLIR station number suppression on a system-wide basis.

---

**INFO:** The flag "System-wide station number display suppression" does not apply to the U.S.

---

#### **Temporary Station Number Suppression**

As a subscriber, you can activate or deactivate the temporary station number suppression (CLIR). A temporary station number suppression is only possible if the system-wide station number suppression has been deactivated.

#### **Station Number Suppression (CLIR)**

As an administrator, you can configure the CLIR for each route so that only the PABX number is transmitted instead of the subscriber's station number.

### 13.2.3.1 How to Enable or Disable Station Number Suppression

#### **Prerequisites**

- You are logged into the WBM with the **Expert** profile.

### *Step by Step*

- 1) In the navigation bar, click on **Expert Mode**.
- 2) In the navigation tree, click on **Telephony > Trunks/Routing**.
- 3) In the menu tree, click **Route**.
- 4) Select the corresponding **Trk Grp..**
- 5) Select the check box **Suppress station number** under **System number - outgoing**.
- 6) Click on **Apply** followed by **OK**.

## 13.2.4 Connected Line Identification Presentation (COLP)

Connected Line Identification Presentation (COLP) transmits the call number of the called subscriber to the caller as soon as the two are connected.

Connected Line Identification Presentation (COLP) is an ISDN feature.

COLP makes sense with call forwarding, for example, so the caller can see the phone number of the actual communication partner instead of the originally dialed phone number.

The Connected Line Identification Presentation (COLP) and Connected Line Identification Restriction (COLR) features are mutually exclusive, that is, as soon as COLP is activated, COLR is deactivated, and vice versa.

### 13.2.4.1 How to Enable or Disable Connected Line Identification Presentation (COLP)

#### *Prerequisites*

- You are logged into the WBM with the **Expert** profile.

#### *Step by Step*

- 1) In the navigation bar, click on **Expert Mode**.
- 2) In the navigation tree, click on **Telephony > Trunks/Routing**.
- 3) In the menu tree, click **Route**.
- 4) Select the appropriate **Trk Grp..**
- 5) Click on the **Special Parameter change** tab.
- 6) Select the check box **COLP**.
- 7) Click on **Apply** followed by **OK**.

## 13.2.5 Connected Line Identification Restriction (COLR)

Connected Line Identification Restriction (COLR) suppresses the display of the called station at the station of the caller.

The Connected Line Identification Restriction (COLR) applies to incoming calls.

The Connected Line Identification Restriction (COLR) has precedence over the Connected Line Identification Presentation (COLP).

The Connected Line Identification Presentation (COLP) and Connected Line Identification Restriction (COLR) features are mutually exclusive, that is, as soon as COLP is activated, COLR is deactivated, and vice versa.

CLIR and COLR can only be enabled or disabled together.

## 13.2.6 CLIP No Screening (Transmission of Customer-Specific Phone Number Information)

CLIP No Screening transmits a call number specified by the caller instead of the caller's own number.

The outgoing system number does not have to be identical to the incoming system number.

The "Suppress station number" flag can be activated for special customer applications. This prevents the system from sending out the DID number of the station along with the outgoing system number.

**Example:** You want to prevent direct customer access to a service staff member who is reached centrally with a general service number. To conceal the staff member's own DID number, enter the general service number as the outgoing PABX number and activate the "CLIP no screening" flag. Then called subscribers see only the general service number on their display as the CLIP.

Incoming and outgoing calls usually use the same system number. In this case, the entry under "System number - outgoing" is either empty or the same as the one under "System number- incoming". If this is not the case, you can

- enter a different number under "System number - outgoing".
- use the routing parameter "No. and type, outgoing" to define whether the "System number - outgoing" entered contains the station number without area code, with area code (national), or also with the international country code (international).

---

**INFO:** CLIP no screening must be supported by the Network Provider and be activated.

---



### 13.2.6.1 How to Configure CLIP No Screening

#### *Prerequisites*

- You are logged into the WBM with the **Expert** profile.

#### *Step by Step*

- 1) In the navigation bar, click on **Expert Mode**.
- 2) In the navigation tree, click on **Telephony > Trunks/Routing**.
- 3) In the menu tree, click **Route**.
- 4) Select the corresponding **Trk Grp.**
- 5) Enter the required **PABX number** under **System number - outgoing**.
- 6) Click on **Apply** followed by **OK**.

### 13.2.7 CLIP for Analog Telephones

CLIP for analog telephones transmits the call number of an analog device of the caller to the called party and displays the CLIP (Calling Line Identification Presentation) on suitable devices of the called party analogously.

The additional transmission of CNIP name information (Calling Name Identification Presentation) can be configured.

---

**INFO:** CNIP is device-independent. Please also refer to the vendor specifications.

---

### 13.2.8 Ringer Cutoff

The Ringer Cutoff feature signals incoming calls acoustically with only a brief alert tone (beep) and on the display.

Ringer Cutoff is only available on phones with displays and has no effect on the signaling of appointments.

### 13.2.9 Translating Station Numbers to Names for System Speed Dialing

For calls made using system speed-dials (SSD) and for incoming calls from system speed-dial numbers, the name associated with the speed-dial destination is displayed after dialing instead of the speed-dial number.

## 13.3 Functions During the Call

The communication system offers several functions during calls, e.g., holding, redirecting and transferring calls.

### 13.3.1 Placing a Call on Hold

Placing a call on hold causes the call to be held in a waiting state. During this period, the caller usually hears an announcement or music on hold.

The hold ends when the held call is retrieved (i.e., resumed).

The following types of holds are possible:

- Common hold:  
Any subscriber can retrieve the call again by pressing a trunk or call key
- Exclusive hold: (only for Team or Top function and at the Attendant Console)  
Only the initiating party can retrieve the call.

#### Placing a Call on Hold and Automatic Recall

A parked call results in an automatic recall when the **Time for parking + change to hold** timer expires (default: 160 s).

### 13.3.2 Parking

Parking a call causes that call to be placed in a waiting state. During this period, the caller usually hears an announcement or music on hold. A parked call can be retrieved from any telephone.

As a subscriber, you assign a park slot (0-9) for a call to be parked. If the park slot you select is already occupied, a negative confirmation tone sounds and the number does not appear on the screen. You can then select another park slot. To retrieve a parked call, you must specify its park slot.

A parked call can be retrieved (unparked) via a code or a correspondingly programmed key and can also be retrieved if another call is waiting at the same time.

#### Parking and Automatic Recall

A parked call results in an automatic recall when the **Time for parking + change to hold** timer expires (default: 160 s).

#### Parking and Call Forwarding

In the case of a recall, a parked call does not follow call forwarding.

### **Parking and DISA**

Parking cannot be enabled via DISA.

### **Parking and Conference Calls**

You cannot park a conference call.

### **Parking and Networking**

A parked call can only be retrieved in the same node. An incoming call over a network can only be parked at the destination node.

### **Parking and Do Not Disturb**

A station with DND enabled can place a call in a park slot; however, if a recall occurs from the parked call, and no other destination was defined in the call management, the call will be automatically disconnected after the recall timer expires.

---

**INFO:** Detailed instructions on how to park a call and how to retrieve a parked call can be found in the relevant chapter of the corresponding device's user guide (OpenStage X Hipath/ OpenScape 3000/ 4000 User Guide).

---

## **13.3.3 Consultation**

In the case of a consultation hold, a subscriber initiates a second call from the same phone or accepts a waiting call. In the meantime, the first call is placed on hold.

A consultation hold is terminated on:

- retrieving the held call or
- Disconnect

This results in either:

- a transfer of the held call or
- an immediate automatic recall from the party on hold to the party that has just hung up

### **Consultation Call using the Direct Station Select (DSS) Key**

Pressing a Direct Station Select (DSS) key during a call initiates a consultation call to the corresponding destination.

### **Connecting two External Parties**

During an external call, a consultation call to another external destination followed by a transfer connects the two external parties. This may involve call charges.

### 13.3.4 Toggle/Connect

The Toggle/Connect feature enables a subscriber to switch between two calls. When the subscriber is talking to one party, the other party is placed on hold.

The subscriber can toggle between the two calls by pressing the appropriate trunk key.

#### **Toggle/Connect and Placing a Call on Hold**

The Toggle function is not available to an on-hold subscriber.

### 13.3.5 Transfer

A transfer enables a subscriber to transfer his or her call to another destination. As soon as a subscriber initiates a transfer, the waiting party is placed on hold for the time being.

The following types of transfers are possible:

- **Blind transfer (also called an unscreened transfer):**  
You can transfer the call without an answer from the subscriber at the destination of the transfer. If the station at the transfer destination is busy, the call is camped on (i.e., call waiting is signaled). If a third party now tries to transfer a call to this busy station or if call waiting rejection has been turned on at the transfer destination, an immediate recall occurs. If the subscriber at the transfer destination does not accept the transferred call within a specified time period ("Dial time during transfer before answer" timer), an automatic recall occurs. A blind transfer (also called an unscreened transfer) to an agent in another Multimedia Contact Center queue is not possible.
- **Consultation transfer:**  
You can transfer the call only if the subscriber at the destination of the transfer answers. The transfer is completed by hanging up the handset.

#### **Transfer with Call Forwarding**

Any call forwarding set at the transfer destination will be followed, i.e., the call will be forwarded accordingly. The display shows the final destination of the transfer.

#### **Transfer with Do Not Disturb**

Transferring a call to a station at which Do Not Disturb is enabled results in an immediate recall to the transferring station even if the transferring station itself also has Do Not Disturb enabled.

#### **System-Specific Information**

"Dial time during transfer before answer" timer: 45 seconds by default

Up to 5 calls can be transferred simultaneously to a busy station.

### 13.3.6 Automatic Recall

An automatic recall is received by the originator of a call if his or her call was placed on hold or parked for too long or if an attempt to transfer that call was unsuccessful.

An automatic recall occurs in the following cases:

- A held or parked call is not picked up again within a specific time period ("Time for parking + change to hold" timer).
- In the case of unscreened transfers, under the following circumstances:
  - The call is not answered before a certain time period expires ("Dial time during transfer before answer" timer)
  - The destination does not exist
  - The destination is busy with a second call
  - The digital phone at the destination is defective
  - The transfer type is not allowed

If the originator (i.e., initiating party) is busy during the recall, the automatic recall will camp on the line. As soon as the originator is free again, the automatic recall is signaled. Either the caller's phone number or that of the destination can be shown on the display or the originator. If the recalled party does not answer the call before the "Intercept time for automatic recall" timer expires, an intercept to the intercept position occurs (if the "On unanswered recall" flag is set). If the intercept position does not answer the recall before the "Time for activation of automatic recall at attendant console" timer expires, the recall is automatically disconnected.

#### Automatic Recall and Call Pickup

Every station in a call pickup group with the initiating party (originator) can pick up an automatic recall if the system-wide flag "Call Pickup after Automatic Recall" is set.

#### Automatic Recall and Do Not Disturb

An automatic recall ignores the Do Not Disturb setting.

#### System-Specific Information

"Intercept time for automatic recall" timer: 30 seconds by default

"Time for activation of automatic recall at attendant console" timer: 60 seconds by default

### 13.3.7 Call Supervision (Selected Countries Only)

Call Supervision allows authorized subscribers to listen in on a call conducted by any internal subscriber. The microphone of the party listening in is automatically muted. The participants in the monitored call are not advised of the monitoring operation by any signal such as a tone or display.

This feature can only be activated in the following countries: Argentina, Australia, Belgium, Brazil, France, United Kingdom, Hong Kong, India, Ireland, Malaysia, New Zealand, Netherlands, Portugal, Singapore, Spain, South Africa, Thailand, United States.

Authorized subscribers need a system phone and the Override class of service.

The subscriber you want to monitor must be actively conducting a call. When you start and end call monitoring, you may encounter a lapse of up to two seconds of the conversation. The monitored connection is released as soon as one of the stations in the connection is put on hold, transferred or the call is ended. The monitored connection can only be resumed when the station to be monitored is again engaged in a call.

**Dependencies**

Topic	Dependency
Cordless phones	You cannot use call monitoring at cordless telephones because they do not support automatic microphone muting.
Conferencing	Call Supervision restricts the number of possible conferences. Maximum number of conferences possible in the system = maximum number of simultaneous call monitoring stations.
Call Supervision	The call can be overridden only using code *944 + station number (not from a menu).
Call Supervision	To enable the use of features at a station, both the station flag <b>Call Supervision</b> and the flag <b>Override class of service</b> on must be activated. (Feature cannot be used with CSTA monitoring.)

**13.3.7.1 How to Activate or Deactivate Call Monitoring for a Station**

*Prerequisites*

- You are logged into the WBM with the **Expert** profile.
- The Override class of service has been activated for the relevant station.

*Step by Step*

- 1) In the navigation bar, click on **Expert Mode**.
- 2) In the navigation tree, click **Telephony > Stations**.
- 3) In the menu tree, click **Stations**.
- 4) Navigate in the menu tree under **Stations > Station > ...** down to the desired station (Index - Station Number - Name).
- 5) Click on the **Edit Station Flags** tab.
- 6) Select one of the following options:
  - If you want to grant the authorization for this function to a station, select the **Call Monitoring** check box.

- If you want to revoke the authorization for this function from a station, clear the **Call Monitoring** check box.

7) Click on **Apply** followed by **OK**.

### 13.3.8 Discreet Call (Whisper)

The Discreet Call (Whisper) feature enables a subscriber (e.g., at station C) to monitor a simple existing connection between two other stations (e.g., A and B) and to pass on information to station A that without being heard by station B. This feature is typically used in Contact Centers and Executive/Secretary systems.

The feature must be configured in E Manager.

---

**INFO:** Although there is no connection between station B and station C, user B may be able to hear the muffled tones of what user C is saying because of feedback on station A.

---

Destination terminals for the Whisper feature (station A) can only be system telephones with displays. Stations A and C must be in the same node.

In the idle/ready state, station C activates this feature by dialing a code. The telephone features a partially programmed key (only the code is programmed on the key, the station number must be suffix-dialed). A new menu item will be incorporated into the Service menu; the Idle/Call menu remains unchanged.

The option for activating the feature is linked to a user-specific class of service. A second class of service can be used to protect station A from a discreet call (whisper/off hook announcement).

The feature is disabled if this is initiated by the activating station C or by the impact of some other call-related feature.

---

**INFO:** If neither of the participants in the original call is a TDM station, the switching network is not involved at the time of activation, and changeover is impossible without briefly interrupting the existing connection.

---

---

**INFO:** Call transfer and conference functionalities are not available from UC Suite products while Discreet Call is activated.

---

If the Whisper/Off Hook Announcement feature is active, and station A or station B initiates another call-related feature, the Whisper feature will be deactivated. The table below provides further information on interaction with particular features:

**Functions at the Telephone**  
 Functions During the Call

Feature	Station A		Station B		Station C	
	Possible	Action	Possible	Action	Possible	Action
Consultation Hold, Call Hold, Park, Common Hold	Yes	Deactivate Whisper/Off Hook Announcement	Yes	Deactivate Whisper/Off Hook Announcement	no	Negative acknowledgement
Transfer	--	--	--	--	--	--
Conferencing	--	--	--	--	--	--
Call waiting	Yes	--	Yes	--	Yes	--
Accept call waiting	Yes	Deactivate Whisper/Off Hook Announcement	Yes	Deactivate Whisper/Off Hook Announcement	Yes	Negative acknowledgement
Override	no	--	no	--	no	--
DTMF transfer	Yes	--	Yes	--	no	--
FEAT counter	--	--	--	--	--	--
Associated Services	--	--	--	--	--	--
DISA/DISI	--	--	--	--	--	--

### 13.3.9 Live Call Recording (Voice Recording)

This feature is used to record data from an active voice connection between two stations (one station must be internal, the other may be external), in other words, to record calls. A separate device is required for recording.

Recording can be started/stopped by pressing a function key or entering a code (analog telephones). Depending on the configuration, recording can also be stopped by the recording device.

The recording equipment can be used by all supported telephones within a CorNet-NQ network. Connections with CorNet-N and QSIG (ECMA, ISO) are not supported. The recording tone can be deactivated during recording.

TDM and CorNet-IP (HFA) telephones (incl. devices without a display) as well as OpenScope Personal Edition (HFA) and optiClient Attendant are supported. Standard H.323 telephones, SIP telephones and EDSS1 stations are not supported.



---

**INFO:** Activated voice recording is indicated by a LED or a recording tone during the call.

Authorization to use voice recording can be individually set for each station .

---

### Dependencies/Restrictions

Subject	Dependency/Restriction
Consultation hold, toggle/connect, transfer, conference	Initiating one of these features when recording a call automatically interrupts voice recording.
Call Hold	Ongoing recording is interrupted by activating "Call Hold". Recording cannot be activated when a station is on hold.
Override	Voice recording is not possible. You cannot override a call that is being recorded. Similarly, you cannot activate recording after overriding a call.
Silent monitoring	Voice recording is not possible. You cannot monitor a call that is being recorded. Similarly, you cannot initiate recording after activating "Silent monitoring".

---

**INFO:** You can only record two-party calls, not conferences or calls involving a held party.

---



---

**INFO:** Additional remarks:

- ) The recording device can be addressed in a random node in a CorNet NQ network.
  - ) Only a limited number of stations in a node can be allocated voice recording authorization (currently limited to 50 stations).
  - ) Conference resources are allocated during recording.
  - ) The default service code for activating call recording is \*493.
- 

## 13.4 Controlling Availability

To control accessibility, the system offers features such as call forwarding, do not disturb and call rejection.

Call destination lists are used for various call forwarding types. Call destination lists define how incoming calls for the assigned station or assigned group are handled. The individual call destinations in a call destination list are processed sequentially. Different entries are possible for internal and external calls (day or night).

### 13.4.1 Call Forwarding

Call Forwarding—No Answer (CFNA) forwards calls that are not answered within a certain period of time.

This type of forwarding is also referred to as fixed call forwarding, since it is only configurable by the administrator.

For each call forwarding, there are one or more call destination lists, which can be assigned to the stations for the following types of calls:

- External calls during the day (when the night service is inactive )
- External calls at night (during active night service)
- Internal calls

For each call destination list, you can specify up to 4 call destinations to which the call is to be forwarded sequentially after a preset time has expired.

Under normal circumstances, the station number or name of the originally called subscriber and the station number or name of the caller are displayed at the call forwarding destination. As an administrator, you can disable the additional display of the station number or name of the caller.

#### Call Forwarding on Busy

Call forwarding on busy forwards an incoming call for a busy extension immediately to the next call destination.

If the call destination is also busy, the caller hears a busy signal. For an internal call, the call remains at the call destination, which is cyclically checked until the destination is free. The administrator defines the cycle.

If the call destination is not available and if no further call forwarding has been configured for it, then the call not forwarded.

#### Dependencies

Topic	Dependency
Analog telephones	There is no indication at these telephones that this call has been forwarded.
Call waiting	If a subscriber enabled call waiting, an incoming call is camped on if call forwarding—busy is configured for him or her.
DND	A call destination which has activated DND, will be skipped.

Topic	Dependency
Call forwarding	Call Forwarding - No Answer (CFNA) is only executed when the call forwarding destination has not responded after a timeout period defined by the administrator.
Night service	If the option "by day / by night" is enabled for a subscriber as the Call Forwarding - No Answer (CFNA) setting, external calls are forwarded in accordance with the settings for the night service. Internal calls are still handled as in the "by day" settings.
External Call Forwarding - No Answer	If external call forwarding - no answer is active, this has precedence over other call forwarding instructions.
Hunt group / Group call	<p>If you enter a group or hunt group as the destination of a call forwarding—no answer instruction, every subscriber in the entire group is called before the next call forwarding destination is evaluated. Group calls and hunt groups can be seen as a call forwarding configuration within a call forwarding configuration.</p> <p>A hunt group is busy if all members are busy or have left the hunt group. A group is always busy if all members of the group are busy.</p>

### 13.4.1.1 How to Configure Call Forwarding

Call forwarding for internal subscribers can be configured for incoming calls by using the **Call Forwarding** wizard.

#### *Prerequisites*

- You are logged on to the WBM with the **Advanced** profile.

#### *Step by Step*

- In the navigation bar, click on **Setup**.
- In the navigation tree, click on **Wizards > User Telephony**.
- Click **Edit** to start the **Call Forwarding** wizard. The **Call dest. list - Definition** window appears.
- First, define a call destination list by clicking on the **Edit** icon in the row of the call destination list to be processed.
- Select the desired destinations in the **Target 1** to **Target 4** drop-down lists. You have the following options:
  - No entry**: The destination is skipped
  - External destination**: Route and external phone number with CO access code
  - \* Called station**: The called subscriber

- **\*\* User defined:** Destination of call forwarding after timeout (if configured).
- **#9 = System search:** Next available station (except for Executive extensions)
- **#201 - #260:** Call Distribution (UCD Group)
- **#801 - #817:** Ann. device
- **100, 101, ...:** Phone number of an internal subscriber or a group (e.g., voicemail box)

---

**INFO:** To find a call destination faster, you can also enter one or more digits in the **Target 1 - Target 4** fields. This takes you directly to the list item that starts with the specified string of digits. It is also possible to enter a character string.

---

- 6) Select the time in seconds after which a call is to be forwarded to the next destination from the **Call forwarding starts after:** drop-down list.
- 7) Select the **Call Forwarding** check box if the call is to be forwarded immediately to the next call destination "on busy".
- 8) If the call is to be signaled at an additional internal station or at a relay (actuator) for a common ringer (night bell), select the desired phone number from the **Second ringer** drop-down list. With **Sec. ringer type**, select whether the call is signaled at the station immediately or after the entire call forwarding time has expired.
- 9) Click **OK & Next**. This will return you to the **Basic Configuration** window.
- 10) If you want to define additional call destination lists, repeat the previous steps.
- 11) Click **OK & Next**.
- 12) Now assign the call destination lists to the stations.
- 13) You can search for a station by typing a search term in the **Call no** or **Name** search fields and then pressing the return key. All matches that contain the search term are displayed. For example, entering the call number 521 would display the matches +495213535 and +498967521, and entering the term `co` as the name would display Collins, Mcoin and Branco.

---

**INFO:** Pressing the return key with nothing entered in any of the search fields causes all entries to be displayed.

---

- 14) Select the call destination lists from the drop-down lists in the row of the desired station for the following cases:
  - **Day:** call destination list to be used for incoming external calls during business hours (day service)
  - **Night:** call destination list to be used for incoming external calls during night service
  - **Internal:** call destination list for incoming internal calls

- 15) Save your entries with **Save** before switching to a station on another page.
- 16) If you want to assign multiple stations conveniently to a call destination list, click **Copy**.
  - a) Under **Call dest. list**, select the call destination to which the stations should be assigned.
  - b) Mark one or more stations in the **Selection** window and transfer them with **Add** to the **Members** window.
  - c) Use the **Day**, **Night** and **Internal** check boxes to select whether the call destination list is to apply to incoming external calls during working hours (day service), when the night service is activated or only to internal calls.
  - d) Click **OK & Next**.
- 17) Click on **OK & Next** again.
- 18) You can have all stations of a call destination list displayed here. To do this, select the desired call destination list in **Show all members with call destination list**.
- 19) Click **OK & Next**. The setup of call forwarding for internal stations is now complete.
- 20) Click **Finish**.

## 13.4.2 Call Forwarding (CF)

Subscribers can use Call Forwarding (CF) to redirect incoming calls to a destination of their choice.

If trunk keys (incl. MULAP trunk keys) have been configured, users can also activate call forwarding individually for a specific trunk (or MULAP trunk).

The following calls can be diverted:

- All calls
- External calls only
- Internal calls only

The following destinations are possible for call forwarding:

- Other phone (internal or external)
- Attendant Console
- Voicemail
- Hunt Group
- UCD group (UCD Universal Call Distribution)

Outgoing calls can still be made when call forwarding is activated.

### External destination

If the call forwarding destination is external, you must enter the trunk access code followed by the external phone number of the forwarding destination.

**Call Forwarding to External Destinations**

If a subscriber has entered an external call forwarding destination in his or her call destination list, forwarding ends at this destination, and any further call forwarding destinations that may have been entered in call destinations list are ignored.

If call forwarding to additional destinations is to occur, the system flag **Hunting to external call forwarding destination** must be activated by the service technician.

If call forwarding to an external destination is to be followed even for a call over an analog trunk, the system flag **Call forwarding to main station interface permitted** must be activated by the service technician.

**Dependencies**

Topic	Dependency
Do Not Disturb	You cannot program call forwarding to a telephone where DND is active.
Appointment, automatic wake-up system	If an appointment comes due, it is signaled at the forwarded telephone, irrespective of any active call forwarding settings.
UCD group as call forwarding destination	<p>A call is not forwarded to a UCD group in the following cases:</p> <ul style="list-style-type: none"> <li>• If a hunt group is called and a subscriber with call forwarding to a UCD group is next, this call is not forwarded. In this case, the next station in the hunt group is immediately called.</li> <li>• A subscriber is a member of a group call with the property "Group" and has activated call forwarding to a UCD group.</li> <li>• A station is a member of a group call no answer. If the group is called, the call is not forwarded to the UCD group. Exception: The first subscriber entered has activated call forwarding to a UCD group. In this case, the call is forwarded.</li> </ul>

**13.4.2.1 How to Enable or Disable Call Forwarding over Analog Trunks**

*Prerequisites*

- You are logged into the WBM with the **Expert** profile.

*Step by Step*

- 1) In the navigation bar, click on **Expert Mode**.
- 2) Click **Telephony > Basic Settings** in the navigation tree.
- 3) Navigate in the menu tree to **System > System Flags**.
- 4) Select one of the following options:

- If you want to enable call forwarding over analog trunks, select the **Call forwarding to main station interface permitted** check box.
  - If you want to disable call forwarding over analog trunks, clear the **Call forwarding to main station interface permitted** check box.
- 5) Click on **Apply** followed by **OK**.

### 13.4.2.2 How to Enable or Disable Call Forwarding to the External Destination

#### *Prerequisites*

- You are logged into the WBM with the **Expert** profile.

#### *Step by Step*

- 1) In the navigation bar, click on **Expert Mode**.
- 2) Click **Telephony > Basic Settings** in the navigation tree.
- 3) Navigate in the menu tree to **System > System Flags**.
- 4) Select one of the following options:
  - If you want to enable call forwarding to the external destination, select the check box **Hunting to external call forwarding destination**.
  - If you want to disable call forwarding to the external destination, clear the check box **Hunting to external call forwarding destination**.
- 5) Click on **Apply** followed by **OK**.

### 13.4.3 Call Forwarding After Timeout

Call Forwarding after Timeout forwards unanswered calls after a specific period of time. Call Forwarding after Timeout is analogous to Call Forwarding No Answer, the only difference being that subscribers can set the call forwarding themselves.

The subscriber can set call forwarding after timeout for his or her own phone and can also enter external destinations and groups.

The call deflection destination is not permanently saved, but deleted after you deactivate the feature.

If a subscriber is busy, the rules of call forwarding - no answer apply, that is, the system proceeds to the next destination.

#### **System-Specific Information**

You can set three destinations for each station. In addition, there is also a special ID "User-defined", via which the administrator can release or lock the Call Forwarding after Timeout feature for a station. The feature is released by default.

If a call is not answered after the preset timeout, the system searches for and calls the call deflection destination saved. If the subscriber has not entered an individual call deflection destination, the system proceeds with the next destination in the call destination list.

The administrator must release the call forwarding after a timeout for the individual subscribers via the call destination lists.

### 13.4.4 External Call Forwarding - No Answer (Not for U.S.)

Every station assigned an MSN (multiple subscriber number at the ISDN point-to-multipoint connection) as a DID number can activate or deactivate call forwarding—no answer for this MSN, provided that the user is authorized to use external call forwarding—no answer.

If you have assigned an MSN to a subscriber group, any member of the group can activate and deactivate external call forwarding-no answer for this MSN.

Users can enter only one forwarding destination per MSN. A total of 10 multiple subscriber numbers can be forwarded.

There are three different versions of the feature:

- Call Forwarding Unconditional (CFU): The network provider forwards all calls to this MSN directly, regardless of the MSN status.
- Call Forwarding Busy (CFB): Calls are forwarded only if the MSN dialed is busy.
- Call Forwarding No Reply (CFNR): Calls are forwarded only if the destination does not answer the incoming call within a preset period of time.

#### Dependencies

Topic	Dependency
Night service	External call forwarding—no answer has a higher priority than night service.

### 13.4.5 Ringing Assignment / Call Allocation

The ringing assignment enables incoming calls of an analog or S<sub>0</sub> trunk to be forwarded to a station or group, depending on the dialed number and the activation state of the night service.

Different destinations are possible for the day and night service. An incoming call is not signaled at the called station, but according to the call destination lists for that station.



### 13.4.5.1 How to How to Configure a Ringing Assignment

#### *Prerequisites*

- You are logged into the WBM with the **Expert** profile.

#### *Step by Step*

- 1) In the navigation bar, click on **Expert Mode**.
- 2) In the navigation tree, click **Telephony > Trunks/Routing**.
- 3) Click on **Trunks/Routing > Trunks** in the menu tree.
- 4) Navigate in the menu tree under **Trunks > ...** (Box-Port code) to the desired analog or S<sub>0</sub> trunk.
- 5) Select the desired station number in the **Day Call no.** drop-down list.
- 6) Select the desired station number in the **Night Call no.** drop-down list.
- 7) Click on **Apply** followed by **OK**.

### 13.4.6 Ringing group on

The feature "Ringing group on" allows internal subscribers to manage a personal list of internal call numbers which are called whenever their own number is called.

Users can also enter their own station numbers. They might do this, for example, if a station number is permanently routed to another station (executive/secretary).

A button can be programmed on the IP system telephones, OpenStage TDM telephones and optiPoint 500 telephones to activate/deactivate this feature. More than one Ringing Group button can be programmed on one telephone to allow for different variations. More than one button can be activated at one time; however, the maximum number of telephones with call signaling cannot exceed five.

This feature can be activated/deactivated via a DISA connection by its own station user or for another user with the aid of the feature Associated Services.

The Forwarding screen is one of three screens in the System Status pathway in Manager E that provides station-specific (rather than system-specific) status information. You can use the Call Forwarding screen to see if a phone has a Ring Group activated or if it is part of a Ring Group.

If the feature is used frequently, the subscribed can assign the feature to a free button on the telephone. The name of the key is "Ringing group on" under Key Programming. When the feature is enabled, the LED is lit.

The station flag "no group ringing on busy" determines which stations in a call ringing group receive a call when the master telephone (the one activating the feature) is busy, and which ones do not. If the same station is in the ringing group of more than one master telephone, the flag applies to all calls signaled at this station.

If the flag is not set, group ringing always takes place, provided the station in the call ringing group is available (default behavior).

If the flag is set, group ringing depends on the availability of the master telephone:

- If the master telephone is available, group ringing takes place immediately  
If the primary telephone has activated call waiting, group ringing takes place after a 5-second delay.  
If the primary telephone cannot receive a call, or if call waiting is inactive, call ringing does not take place.

Topic	Dependency/Restriction
Automatic recall System search Callback	Group ringing is not carried out with an immediate recall (operator error), system search or callback.
Call forwarding	If the station that activated group ringing has also activated call forwarding, group ringing does not occur.
Do Not Disturb (DND)	If a station in the call ringing group has activated DND, group ringing is not carried out at that station.
Timed reminder	An active timed reminder does not follow group ringing.
No group ringing on busy	If the flag is set, no group ringing will take place if the station is busy.

### 13.4.7 Rejecting Calls

The subscriber can reject internal and external incoming initial calls. These calls can be rejected by pressing the Disconnect key.

The rejected call is then forwarded in accordance with the CFNA instruction. If there is no other call forwarding destination, an external call is intercepted by the attendant console, provided the relevant intercept criteria were configured. If no destination can be called, the caller continues to receive a busy signal.

Transferred recalls, queued callbacks, held or parked calls cannot be rejected. An intercepted call sent to the Intercept position cannot be rejected.

#### Dependencies

Topic	Dependency
Group call, hunt group call, MULAP	In these cases, the entire group call is terminated and the call follows the call forwarding instruction configured. The call is terminated if there is no other call destination.

## 13.4.8 Deferring a Call

Subscribers are provided the option of deferring an incoming call. The subscriber called can set up a connection without picking up the incoming call.

The waiting call is then signaled as a camped-on call.

If an incoming call is signaled, the subscriber can press a call or trunk key to conduct the external call. Two call keys and one trunk key must be programmed for this. One of the relevant keys must be free to execute the feature.

The calling party does not notice a change in signaling if call waiting is set for ringing on call waiting.

## 13.4.9 Do Not Disturb

Do Not Disturb prevents incoming calls from being put through.

A subscriber who has activated DND hears a special dial tone when he or she lifts the handset. When active, the Do Not Disturb feature is also indicated on display phones. In all other phones, the LED on the DSS key flashes with a brief interruption on stations where Do Not Disturb is active.

The Do Not Disturb feature, if set, can be overridden by the Attendant or an authorized subscriber. The call can also be immediately put through for a subscriber with an active Do Not Disturb feature.

A caller who dials a telephone with DND activated receives a busy signal and is not allowed to camp on.

### Dependencies

Topic	Dependency
Attendant/night destination	The attendant and the current intercept position cannot activate the Do Not Disturb feature.
Call forwarding	You cannot specify DND if call forwarding is active on the same telephone. You cannot activate call forwarding to a telephone with DND.
Callback	If a callback is initiated to a station with DND activated, the callback is not executed until DND is deactivated. If the subscriber with DND activated initiates a callback, this will override the DND function.
Appointment, automatic wake-up system	If a station has set an appointment and activated DND, an audible signal is sent to the telephone when the appointment comes due.
DISA	DISA can be activated by the subscriber for his or her own phone or by a user for another phone (associated services).

## 13.5 Optimizing Communication

The communication system offers various options to conveniently and effectively handle calls, e.g., through callbacks or call waiting.

### 13.5.1 Callback

A callback can then be activated if the subscriber called does not answer or is busy. An active callback triggers a call as soon as the called subscriber is available.

#### **Automatic Callback When Free or Busy**

If a call cannot be set up because the subscriber called is busy or does not accept the call, the calling subscriber can activate a callback to set up the call at a later time. If the subscriber called was busy, the Callback function monitors the call to see when it ends. The calling subscriber receives a signal in the form of a call from the communication system when the other subscriber's line is free. If he or she accepts this call, the subscriber who was previously busy is redialed. If a call set up via the Callback function is not successful, this function remains active. The callback attempt is repeated once the required subscriber has conducted another call.

A telephone can initiate up to two Callback requests and be the destination for up to two requests. Any further outgoing requests are rejected.

Callback requests are deleted when

- the call is completed; if not, the callback remains in effect (for an internal callback),
- the callback was established without a call being completed (for an external callback),
- the initiator cancels the request,
- the system deletes all callbacks daily at 23:57.

Callback requests can be made for internal subscribers and groups. Callback requests for a group call are stored at the first subscriber. When a callback is made to a group, the ring is heard at all phones that are free.

#### **Automatic Call Completion on No Reply (CCNR) on the Trunk Interface**

An internal subscriber who cannot reach an available external subscriber can activate a callback request at the central office. The system then monitors the connection of the called subscriber. As soon as the called subscriber initiates a connection setup and then ends this connection, the central office attempts to establish a connection between the two subscribers. This feature must be supported by the central office.

### Callback on busy

This feature sets enables a manual callback to be set on an external station that is busy. When the station becomes free, the trunk attempts to set up a connection between the two stations. The feature must be supported and enabled by the central office and peer.

## 13.5.2 Call Waiting

Call waiting signals the arrival of a further incoming call to a subscriber who is on the phone.

The incoming call is visually signaled by a message on the display. It can also be signaled acoustically by a short call waiting tone. The call waiting tone can be heard every 5 seconds.

The subscriber called can accept this second call or ignore it. To answer the second caller, the subscriber can optionally end the first call and answer the second or select the **Call waiting** function offered in the display. In the latter case, the first call is placed on hold.

You cannot camp on to a subscriber if someone is already camped on (a maximum of 4 subscribers can camp on) or if the subscriber has activated call waiting rejection. The caller receives a busy signal if call forwarding—busy is not configured.

### Enabling Call Waiting

If the **Call waiting rejection** flag is set, the subscriber can use a menu or code to either enable or suppress call waiting. If a subscriber has enabled call waiting, an incoming call is camped on if call forwarding—busy is configured.

### Call Waiting (Camp On) by Attendant Console

The default setting is always "call waiting after timeout". However, the Attendant Console can also camp on immediately.

### Dependencies

Topic	Dependency
Call waiting tone	The subscriber can activate/deactivate the call waiting tone with a code. Call waiting is still visually signaled on the phone's display. The call waiting tone is active by default.
Override	If call waiting rejection is active, an ongoing call by this subscriber cannot be overridden.
Group Call	If one or more stations in a group call are free, the call will be offered to them. If all stations are busy, all of them receive a call waiting signal, apart from any stations where call waiting rejection is active.
Speaker call	Speaker calls to busy stations are not possible.

### 13.5.2.1 How to Enable or Disable Call Waiting

#### *Prerequisites*

- You are logged into the WBM with the **Expert** profile.

#### *Step by Step*

- 1) In the navigation bar, click on **Expert Mode**.
- 2) In the navigation tree, click on **Telephony > Stations**.
- 3) In the menu tree, click **Stations**.
- 4) Click **IP Clients**, for example.
- 5) Click **System Clients**, for example.
- 6) Select the relevant station.
- 7) Click on the **Edit Station Flags** tab.
- 8) Select one of the following options:
  - If you want to enable call waiting, clear the Call waiting rejection on check box.
  - If you want to disable call waiting, select the check box **Call waiting rejection on**.
- 9) Click on **Apply** followed by **OK**.

### 13.5.2.2 How to Enable or Disable Immediate Call Waiting (Camp On) by the Attendant Console

#### *Prerequisites*

- You are logged into the WBM with the **Expert** profile.

#### *Step by Step*

- 1) In the navigation bar, click on **Expert Mode**.
- 2) Click **Telephony > Basic Settings** in the navigation tree.
- 3) Click **System** in the menu tree.
- 4) Click on **Intercept/Attendant/Hotline**.
- 5) Select one of the following options under **Other criteria**:
  - If you want to activate the function, enable the check box **Immediately camp on for attendant calls**.
  - If you want to deactivate the function, clear the check box **Immediately camp on for attendant calls**.
- 6) Click on **Apply** followed by **OK**.

### 13.5.3 Override (Intrusion)

The Override feature enables an authorized subscriber to override (i.e., intrude into) a call of another internal subscriber.

The override (intrusion) occurs by means of a code or key, and the subscriber involved is notified by a warning tone (beep) and a visual signal on the display.

The feature can be invoked during the busy signal or during the camp on state.

During an override condition, the following applies:

- If the called party hangs up, he or she receives a call from the switching party.
- If the overriding party (who wants to switch the call and overrides) hangs up, the call is switched through to the destination station.
- If the party which was connected to the called party hangs up, the overridden and called parties remain connected.

An override can be performed by any internal subscriber and the intercept position (attendant console). However, in order to use this feature, the internal subscriber and even the intercept position must be authorized for this.

It is not possible to prevent an override to a particular telephone.

#### Dependencies

Topic	Dependency
Voice Channel Signaling Security	You cannot override a call if the called station or the internal party it is connected to is entered as a data station (voice channel signaling security), or if the called party is dialing a number.
Do Not Disturb	If the called station has activated Do Not Disturb, only one call can be overridden when the subscriber is conducting a call.
Hunt group	Busy override is not possible if all stations are busy when a group or hunt group is called.
S <sub>0</sub> station	It is not possible to override an S <sub>0</sub> station.

#### 13.5.3.1 How to Authorize an Internal Station for the Override Feature

##### Prerequisites

- You are logged into the WBM with the **Expert** profile.

##### Step by Step

- 1) In the navigation bar, click on **Expert Mode**.
- 2) In the navigation tree, click on **Telephony > Stations**.
- 3) In the menu tree, click **Stations**.

- 4) In the menu tree, click the station (Index - Call number - Name).
- 5) Click on the **Edit Station Flags** tab.
- 6) Activate the check box **Override class of service on**.
- 7) Click on **Apply**, followed by **OK**.

### 13.5.3.2 How to Authorize the Intercept Position for the Override Feature

#### *Prerequisites*

- You are logged into the WBM with the **Expert** profile.

#### *Step by Step*

- 1) In the navigation bar, click on **Expert Mode**.
- 2) Click **Telephony > Basic Settings** in the navigation tree.
- 3) Click on **System > Intercept/Attendant/Hotline** in the menu tree.
- 4) Select the **Override by Attendant** check box in the **Other criteria** area.
- 5) Click on **Apply** followed by **OK**.

## 13.5.4 Advisory Messages

The advisory message of a subscriber appears in the caller's display.

Variable parameters can also be assigned in advisory messages (also referred to as absence texts). These parameters (for example, time) are entered in the course of activation. Users can use the numeric keypad on the telephone to enter additional characters. The advisory message can be activated/deactivated at a phone via a code or a preconfigured function key.

#### **Call forwarding**

When call forwarding is enabled, the called subscriber's advisory message is displayed and the call is forwarded.

### 13.5.4.1 How to Edit Advisory Messages

#### *Prerequisites*

- You are logged into the WBM with the **Expert** profile.

#### *Step by Step*

- 1) In the navigation bar, click on **Expert Mode**.
- 2) Click **Telephony > Basic Settings** in the navigation tree.



- 3) Click **System** in the menu tree.
- 4) Click on **Texts**.
- 5) Click on the relevant field in the **Answer texts** column and enter your advisory message.
- 6) Click on **Apply** followed by **OK**.

### 13.5.5 Message Texts

Message texts are internal system texts that can be selected by a subscriber and sent to internal subscribers.

A message text (also called an Info text) can be sent to one or more recipients.

If you want to send the text to all members of an internal group or an internal hunt group, you must specify the phone number of the group or the hunt group - not an individual subscriber - as the recipient.

---

**INFO:** Only 100 phones can receive mass Message Waiting Indication (MWI) messages, any additional message will fail.

---

The message is sent by pressing the relevant button or via the Send Message menu.

The message can be sent in idle, ringing, talk or busy state. In ringing state it is not necessary to specify the recipient's station number.

#### 13.5.5.1 How to Change a Message Text

##### *Prerequisites*

- You are logged into the WBM with the **Expert** profile.

##### *Step by Step*

- 1) In the navigation bar, click on **Expert Mode**.
- 2) Click **Telephony > Basic Settings** in the navigation tree.
- 3) Click **System** in the menu tree.
- 4) Click on **Texts**.
- 5) Click on the relevant field in the **Info texts** column and enter the text.
- 6) Click on **Apply** followed by **OK**.

## 13.5.6 Associated Services

An authorized station can control certain features on behalf of any other station, e.g., call forwarding, turning the lock code or hunt group on/off, etc. The effect is the same as if the feature involved were activated or deactivated by the other station itself.

The following features can be controlled on behalf of other stations:

- Call forwarding on / off
- COS changeover on / off
- Ringing group on / off
- Advisory message on / off
- Hunt Group and Group Call on / off
- Night service on / off
- Timed reminder on / off
- Send message / Delete sent message
- Edit lock code password
- UCD agent log in / log out
- UCD agent Available/Not available
- UCD agent Wrapup on / off
- UCD agent Night service on / off
- Forward Line Key (MULAP) on / off
- Resetting Activated Features

This is operated via a procedure. The station must specify the following:

- the code for Associated Services
- the station number of the subscriber for whom the action is to be performed.
- the code of the feature to be controlled

Before any subscriber can use the Associated Services, he or she must first disable the lock code of the other subscriber (if enabled).

### 13.5.6.1 How to Activate or Deactivate Associated Services

#### *Prerequisites*

- You are logged into the WBM with the **Expert** profile.

#### *Step by Step*

- 1) In the navigation bar, click on **Expert Mode**.
- 2) In the navigation tree, click on **Telephony > Stations**.
- 3) In the menu tree, click **Stations**.
- 4) In the menu tree, click the station (Index - Call number - Name).

- 5) Click on the **Edit Station Flags** tab.
- 6) Select one of the following options:
  - If you want to activate the function, select the check box **Associated dialing/services**.
  - If you want to deactivate the function, clear the check box **Associated dialing/services**.
- 7) Click on **Apply** followed by **OK**.

## 13.5.7 DISA

DISA (Direct Inward System Access) allows authorized subscribers to use features of the communication system from outside, e.g., at the mobile phone using myPortal for Mobile (for mobile callback) and Mobility.

Using DISA, a subscriber can also set up outgoing connections, both internal and external. Whenever a subscriber uses DISA, he or she must enter the password for the lock code. Certain features are then available as for internal use.

DISA supports the following features:

Feature	by the subscriber him/ herself	via associated services
Call forwarding on / off	x	x
Do not disturb on / off	x	x
Hunt group on / off	x	x
Advisory message on/off	x	x
Ringing group on / off	x	x
COS changeover on / off	x	x
Reset services	x	x
System Speed Dialing	x	–
Send message text	x	–
Night service on / off	x	–

The administrator specifies under which call number the stations can access DISA. The call number may be different for external and internal use. Internal means at some other "IP-networked" node.

The password to be entered by subscribers consists of the internal call number and the PIN for the lock code. After entering the password, subscribers must either press the # key or wait until the communication system has recognized their input, depending on the security mode that was set for DISA by the administrator.

The subscriber must log in again for further action via DISA.

### 13.5.7.1 How to Activate or Deactivate a DISA Class of Service for a Station

#### *Prerequisites*

- You are logged into the WBM with the **Expert** profile.

#### *Step by Step*

- 1) In the navigation bar, click on **Expert Mode**.
- 2) In the navigation tree, click on **Telephony > Stations**.
- 3) In the menu tree, click **Stations**.
- 4) In the menu tree, click the station (Index - Call number - Name).
- 5) Click on the **Edit Station Flags** tab.
- 6) Select one of the following options:
  - If you want to activate the function, select the check box **DISA Class of Service**.
  - If you want to deactivate the function, clear the check box **DISA Class of Service**.
- 7) Click on **Apply** followed by **OK**.

### 13.5.7.2 How to Configure a DISA Number

#### *Prerequisites*

- You are logged into the WBM with the **Expert** profile.

#### *Step by Step*

- 1) In the navigation bar, click on **Expert Mode**.
- 2) Click **Telephony > Basic Settings** in the navigation tree.
- 3) In the menu tree, click **Basic Settings > System > DISA**.
- 4) In the field **DID**, enter the call number via which the stations can use DISA externally.
- 5) In the field **Phone Number**, enter the call number via which the stations can use DISA internally.
- 6) Click on **Apply** followed by **OK**.

### 13.5.7.3 How to Configure the DISA Security Mode

#### *Prerequisites*

- You are logged into the WBM with the **Expert** profile.

### Step by Step

- 1) In the navigation bar, click on **Expert Mode**.
- 2) Click **Telephony > Basic Settings** in the navigation tree.
- 3) In the menu tree, click **Basic Settings > System > DISA**.
- 4) In the **Security Mode** drop-down list, select the item **After timeout** or **After input #**.
- 5) Click on **Apply**, followed by **OK**.

## 13.5.8 Flex Call/Mobile PIN

Flex Call (Mobile PIN) enables a system telephone to be temporarily used by other subscribers for the next outbound call as if that phone were their own phones.

Flex Call includes this subscriber's phone number, name, toll restriction, and call detail recording.

The phone being used cannot be reached at its own station number if Flex call is enabled. This status is reverted at the end of the call.

To enable Flex Call, an individual code lock must have been assigned for the mobile subscriber.

One of the following steps must be performed at the system phone to activate the feature:

- OpenStage: Service Menu > PIN and Class of Service > Flex Call + Mobile phone number + Lock code of mobile subscriber
- Code for Flex Call + Mobile phone number + Lock code of mobile subscriber

## 13.5.9 Relocate

The Relocate (Hoteling) feature allows an OpenStage TDM station to use a procedure to change the assignment between the physical telephone port and the logical station data (user profile).

The Relocate feature can be used if two users decide to swap their workplaces and both users share the same phone types. Relocate thus enables the implementation of DeskSharing for TDM users. The TDM users can perform the Relocate operation without the assistance of an administrator.

Only user profiles of the same phone type, i.e., with an identical key layout, may be exchanged. If you exchange user profiles from different phone types, individually programmed key functions on the basic device will be replaced by the default values. Executing the Relocate feature causes the TDM telephones involved to go out of service and restart. Enabled features are treated accordingly, i.e., current callbacks and sent infos are deleted, and all other features are preserved.

The use of Relocate requires a system-wide release of the feature. To enable the feature, select Relocate in the service menu of the phone to be exchanged and enter the internal number of the target station and the lock code PIN (the lock code PIN is not required if the default PIN 00000 is being used). After you have entered the destination call number, the Relocate feature is blocked for all other users until the procedure has completed. When executing the exchange, both telephones involved are reset. The successful exchange is indicated on both TDM phones by the display of the new number (display: New Call No.: XXXXX).

Relocate cannot be performed on system telephones with programming authorization (for Assistant T). In other words, Relocate is usually not possible on the first two active system telephones.

### 13.5.9.1 How to Unlock Relocate on a System-wide Basis

#### *Prerequisites*

- You are logged into the WBM with the **Expert** profile.

#### *Step by Step*

- 1) In the navigation bar, click on **Expert Mode**.
- 2) In the navigation tree, click **Basic Settings > System**.
- 3) Click **System Flags** in the menu tree.
- 4) Select the **Relocate allowed** check box.
- 5) Click on **Apply** followed by **OK**.

### 13.5.10 Reset activated features

You can reset specific features collectively at your terminal using a code.

This is possible for the following features:

- Call forwarding
- Delete received infos
- Advisory message on / off
- Ringing group on / off
- Hunt group on / off
- Station number suppression on / off
- Silent camp-on on / off
- Do not disturb on / off
- Ringer cutoff on / off
- Appointment
- Cancel all callbacks

## 13.5.11 Procedures

The communication system lets the subscriber program a key with codes, phone numbers, and other dialing information. If a subscriber presses the Procedure key as a suffix or during a call, the communication system transmits the corresponding DTMF character (DTMF = dual tone multifrequency).

Sample applications:

- Code for callback
- Code for call waiting
- Code for override
- Digit string for voicemail or answering machine
- Trunk flash code + destination station number
- Code for controlling a service + destination phone number, for example, code for send/retrieve message (message waiting) + phone number + text number
- ACCT (account code) + trunk code + destination station number

Procedures that require PIN input cannot be saved.

Only the first key level supports Procedure keys.

Depending on the situation, a subscriber can use the following features in procedures:

Feature	Ready to dial	Busy	On the phone	Outgoing call	Incoming call
Directed call pickup	x	–	x	–	–
Call Forward on, (not for tenant systems; not for individual MSNs in an S <sub>0</sub> trunk connection)	x	–	x	x	–
External call forwarding on / off; toggle function; (not for tenant services);	x	–	x	x	–
Call forwarding, login/UCD (uniform call distribution), logout; toggle function	x	–	x	x	–
Call forwarding, night destination on / off; toggle function	x	–	x	x	–
Call forwarding per team configuration	x	x	x	x	x
Advisory message on / off; toggle function	x	–	x	x	–
Associated Dialing	x	x	x	x	x
Associated Services	x	–	x	x	–
Speaker call	x	–	x	–	–
Release trunk (emergency trunk access)	x	–	x	x	–
Send message (message waiting)	x	–	x	x	–
Dial station speed dialing	x	–	x	x	–
Dial system speed dialing	x	–	x	x	–
DTMF transmission	–	–	x	–	–

**Functions at the Telephone**  
Optimizing Communication

Feature	Ready to dial	Busy	On the phone	Outgoing call	Incoming call
DTMF transmission in the talk state using procedure key	x	x	x	x	x
Night service on / off; toggle function	x	–	x	x	–
Retrieve call; toggle function	–	x	x	x	–
Account code ACCT	x	–	x	–	–
Account code ACCT in prefix	x	–	x	–	–
Callback requests - display or delete; toggle function	x	–	–	–	–
Ringing group on / off; toggle function	x	–	x	x	–
Language selection	x	x	x	x	x
Telephone Data Service TDS	x	–	x	x	–
Door opener via adapter cabinet	x	x	x	x	x
Timed reminder; toggle function	x	x	x	x	x
Retrieval of an external call from common hold	x	x	x	x	x
System Telephone Lock	x	–	x	–	–

**System-Specific Information**

A procedure key can store up to 32 characters.

**13.5.12 Automatic Wake-up System and Timed Reminders**

All users can program timed reminders (appointments). They will be reminded of the appointment at the set time. The appointment can be programmed for a single reminder (once within a 24-hour period) or for regularly scheduled daily reminders.

The time format is four-digits. The first two digits are the hour, and the second two digits are the minutes. A 12-hour clock mode is supported for the U.S.: users enter the four digits and then select "am" (key 2) or "pm" (key 7). If nothing is specified, "am" will be used as the default setting.

Analog telephones, optiPoint 500 and CMI telephones support only programming of non-repeating appointments.

The default timed reminder sounds for 20 seconds and will repeat a maximum of five repeats at one-minute intervals. The timed reminder is cleared automatically as soon as the user lifts the handset or presses the speaker button, or after the fifth repeat (number of repeats is configurable). Alternatively, a programmed timed reminder can be canceled using a procedure. Display telephones also support queries.

A timed reminder which is due but cannot be signaled (user busy, for example), is postponed until the next cycle.



## 14 Working in a Team (Groups)

Several features are provided by the communication system to enable and facilitate working in a team. Besides call pickup groups, group calls and hunt groups, this also includes groups with team and executive/secretary functions as well as voicemail box and fax box groups. The "UCD (Uniform Call Distribution)" feature enables incoming calls to be uniformly distributed to a group of users (UCD group).

---

**INFO:** When configuring groups, it must be noted that the first three groups are reserved:

The first group is used by default as the hunt group for Xpressions Compact.

The second group is used by default as the hunt group for OpenScape Business Smart VoiceMail.

The third group is used by default as the hunt group for the Company AutoAttendant of OpenScape Business Smart VoiceMail.

---

### 14.1 Call Pickup Group, Group Call and Hunt Group

The communication system offers several methods of combining stations into groups so that multiple subscribers and phones can be reached under one call number, for example, or a call to one station can also be signaled at other stations.

In the case of a call pickup group, a call for one member of the group is also signaled at all other group members.

With a group call, by contrast, all members can be reached via a single phone number (group phone number). The first station to answer the call is connected to the calling party.

In the case of a hunt group, an incoming call is signaled at one of the group members. If this member does not answer the call, the call is assigned to the next member. All members of the hunt group can be reached at the same phone number.

#### 14.1.1 Call Pickup Group

A call for a member of a call pickup group is also signaled at all other group members. The call can be accepted by all group members via a function key programmed for this purpose, via the associated phone menu item or by dialing the code.

## Working in a Team (Groups)

Call Pickup Group, Group Call and Hunt Group

The call is signaled acoustically and visually on the display of the call pickup group member originally called. If programmed, the call is also signaled via the function key LED.

The other group members are only notified of the call by a visual signal. The phone number or name of the subscriber originally called and the phone number or name of the caller are shown on the phone's display. The display of the station number or name of the caller can be disabled by an administrator with the **Expert** profile in **Expert mode**. If programmed, the call is also signaled via the function key LED.

If the call is not accepted within four ring cycles (4 x 5 seconds), the other group members receive a warning tone (acoustic signaling). The time from the start of call signaling till the warning tone is not variable. The warning tone can be disabled for all group members by an administrator with the **Expert** profile in **Expert mode**.

If more than one call is received for a call pickup group, signaling occurs in the sequence in which the calls are received.

If recalls for members of a call pickup group are also to be picked up by other members in the group, this must be enabled by an administrator with **Expert** profile in **Expert mode**.

A station can belong to only one call pickup group.

Any call charges incurred for a picked-up call are accrued to the subscriber who picked up the call.

---

**INFO:** Double quotations (") are not supported for naming a Call Pickup Group.

---

## SIP Phones

SIP telephones can be integrated in a call pickup group.

---

**INFO:** In addition, a function key for the call pickup group can be programmed for SIP phones, and the specific messages of a call pickup group can be shown on the displays of the corresponding SIP phones. In order to use this feature, the "Call Pickup Group" feature must be enabled on the SIP phone (see the User Guide of the SIP phone for details).

---

## Call Pickup Outside a Call Pickup Group

Another version of the feature is the "call pickup outside a call pickup group". This permits the pickup of calls for internal subscribers that do not belong to the same call pickup group. The call can be picked up via a function key programmed for this purpose, the associated menu item or by dialing the specific call pickup code followed by the station number of the called station.

## Dependencies

Topic	Dependency
Callback	Recalls and callbacks are signaled at the other group members only if the system flag <b>Call Pickup after automatic recall</b> has been activated.
Do Not Disturb	Stations that have activated DND do not receive call pickup signaling.
ISDN Phones	It is not possible to include ISDN telephones in call pickup groups.
MULAP	It is not possible to include MULAP phone numbers in call pickup groups.

---

## Related Topics

- [How to Configure a Call Pickup Group](#)
- [How to Add or Delete a Member to or from a Call Pickup Group](#)
- [How to Enable or Disable the Display of a Caller's Station Number and Name](#)
- [How to Activate or Deactivate the Warning Tone](#)
- [How to Enable or Disable Call Pickup for Recalls](#)

## 14.1.2 Group Call

A group call can be defined in cases where multiple subscribers need to be reached via a single phone number (group phone number). Incoming external and internal calls are signaled at the same time at all group member phones. The first station to answer the call is connected to the calling party.

Every member of a group call can also be reached at his or her own station number.

The group must be assigned one of the following properties:

- **Group**  
Incoming calls are simultaneously signaled at all available group members. Available group members are subscribers who are not busy. If all group members are busy, a call is signaled by a camp-on tone. Call signaling continues at all group members (camp-on tone at busy group members) even if the subscriber hangs up.  
A caller hears the busy tone if all group members are busy and all have activated the DND feature. If a call forwarding destination has been defined for this group, the caller does not hear a busy tone, but is forwarded directly to the next call forwarding destination.
- **RNA**  
Incoming calls are simultaneously signaled at all group members. If a group member is busy, the entire group call is marked as busy. Other callers receive the busy tone.

## Working in a Team (Groups)

Call Pickup Group, Group Call and Hunt Group

- **Call waiting**  
Incoming calls are simultaneously signaled at all available group members. Available group members are subscribers who are not busy. A call is signaled by a camp-on tone for busy group members.  
This requires that all group members have the Do Not Disturb feature disabled.

Group calls are treated like stations by the Call forwarding—no answer function. In other words, if a call cannot be accepted by any of the members in a group call, it is redirected to a call forwarding destination in accordance with the call destination list. You can specify whether call forwarding should be performed on RNA (ring no answer) or busy.

When a call is not answered by any member of a group call, it appears as a missed call in the journal of the UC clients of all members. An accepted call appears only in the journal of the member who answered the call.

A single station can belong to several groups simultaneously. The following applies to groups of the type Group Call, Hunt Group, Team Configuration / Team Group and Executive/Secretary / Top Group: The sum of all the subscriber's memberships in these groups must not exceed 32.

The group name assigned is shown on the internal caller's display. After a call is accepted, the name of the subscriber who accepted the call is displayed.

If a member has defined rules using the AutoAttendant, e.g., to forward calls, these rules will apply only to calls to his or her own station number. The rules are ignored for group calls.

Up to 20 subscribers can be configured per group call.

Every group call can be assigned a name containing up to 16 characters.

### **Voicemail Box for Group Call**

When setting up a group call, a voicemail box is created automatically. The call number of this voicemail box for the group call always matches that of the group call. If a group call is not accepted by any member, the call is forwarded to the voicemail box for the group call. This requires the group call voicemail box to have been defined as the CFNA (call forwarding on no answer) destination of this group call.

If a member does not accept an incoming call to his or her own station number, this call is redirected to a call forwarding destination in accordance with the call destination list.

Example of a group call of type RNA (ring no answer) with the group call number 404 and the members A (call number 200), B (201) and C (202). Call Forwarding-No Answer after Timeout to the voicemail box of the group call was set up for the group call. Every member has defined Call Forwarding-No Answer (CFNA) after Timeout to his or her own voicemail box.		
Inbound call for Member A (200)	All members are free.	Member A does not accept the call. Call Forwarding-No Answer after Timeout occurs to the voicemail box of member A.
	Member A has defined Call Forwarding Unconditional (CFU) to his or her own voicemail box. Members B and C are free.	The call is forwarded immediately (CFU) to the voicemail box of member A.
Inbound call for the group call (404)	All members are free.	The call is signaled at all other members. No member accepts the call. Call Forwarding-No Answer after Timeout occurs to the voicemail box of the group call.
	Member A has defined Call Forwarding Unconditional (CFU) to his or her own voicemail box. Members B and C are free.	The call is signaled at members B and C. No member accepts the call. Call Forwarding-No Answer after Timeout occurs to the voicemail box of the group call.
	Member A has defined Call Forwarding Unconditional (CFU) to an external destination. Members B and C are free.	The call is signaled at members B and C and at the external destination. No member accepts the call. Call Forwarding-No Answer after Timeout occurs to the voicemail box of the group call.
	Member A has defined CFNA rules using the AutoAttendant. Members B and C are free.	The call is signaled at all other members. No member accepts the call. Call Forwarding-No Answer after Timeout occurs to the voicemail box of the group call.

### Activating/Deactivating a Group Call

If a subscriber is a member of a group call, he or she can use codes to leave and rejoin the group call.

If a subscriber is a member of both multiple group calls and multiple hunt groups, he or she can use codes to leave and rejoin all group calls and hunt groups. Subscribers are added to or removed from a specific group call or hunt group by entering codes and then making a selection from the group calls and hunt groups displayed.

You can also program function keys with a shift function for joining and leaving. You can program a function key here that applies for a specific group call and hunt group or all group calls and hunt groups. Variable programming is also possible. After you press a function key of this kind, you must select one of the group calls

## Working in a Team (Groups)

Call Pickup Group, Group Call and Hunt Group

and hunt groups displayed to define the group call or hunt group you want to leave/join.

### Ring type

For every group call, an administrator with the **Expert** profile can define the acoustic signaling of incoming external calls via the ring type setting. You have the following options:

- Two rings (default setting)
- Three rings
- short-long-short ring

Only the default setting is possible for analog phones. Changes have no effect.

### SIP Phones

SIP telephones can be integrated in a group call.

---

**INFO:** No programming of function keys is possible for SIP phones. Furthermore, no features can be activated or deactivated via codes. Specific display messages of a group call are not supported.

---

### Dependencies

Topic	Dependency
Call forwarding	If a group member activates call forwarding for all calls, all calls are signaled at the destination telephone.
Do Not Disturb	If a group member activates the Do Not Disturb feature, incoming calls for his or her phone are not put through. This applies to calls via the group phone number and the member's own station number.
Override	Override is not possible if all members of a group call are busy.
ISDN Phones	It is not possible to include ISDN telephones in a group call.

---

### Related Topics

- [How to Add a Group Call \(Group\)](#)
- [How to Edit a Group Call \(Group\)](#)
- [How to Delete a Group Call \(Group\)](#)
- [How to Add or Delete a Member to or from a Group Call \(Group\)](#)
- [How to Add a Group Call \(RNA or Call Waiting\)](#)
- [How to Display or Edit a Group Call \(RNA or Call waiting\)](#)
- [How to Delete a Group Call \(RNA or Call Waiting\)](#)
- [How to Add or Delete a Member to or from a Group Call \(RNA or Call Waiting\)](#)

- [How to Enable or Disable Do Not Disturb for a Group Member](#)

### 14.1.3 Hunt Group

Hunt groups permit the distribution of incoming calls to associated subscribers (members). If a subscriber is busy or does not accept an incoming call, the call is automatically forwarded to the next free member of the hunt group. All members of the hunt group can be reached at the same phone number.

Every member of a hunt group can also be reached at his or her own station number.

The hunt group must be assigned one of the following properties.

- **Linear**  
An inbound call is always signaled first at the first member of a hunt group. Further signaling is performed on the basis of the sequence in which the members are entered in the group table.
- **Cyclic**  
An inbound call is always signaled first at the member that follows the subscriber who answered the last call. Further signaling is performed on the basis of the sequence in which the members are entered in the group table.

The call is automatically forwarded to the next free hunt group member when the forwarding time expires, provided the call is not answered or a member is busy or DND is activated.

You can program a call forwarding destination (call destination list) if a call cannot be answered by any of the members of the hunt group.

A single station can belong to several groups simultaneously. The following applies to groups of the type Group Call, Hunt Group, Team Configuration / Team Group and Executive/Secretary / Top Group: The sum of all the subscriber's memberships in these groups must not exceed 32.

The name assigned to the hunt group is shown on the internal caller's display. After a call is accepted, the name of the subscriber who accepted the call is displayed.

If a member has defined rules using the AutoAttendant, e.g., to forward calls, these rules will apply only to calls to his or her own station number. The rules are ignored for hunt group calls.

Up to 20 subscribers can be configured per hunt group.

Every hunt group can be assigned a name containing up to 16 characters.

#### **Voicemail Box for Hunt Group**

When setting up a hunt group, a voicemail box is automatically created for it. The call number of this voicemail box for the hunt group always matches that of the hunt group. If a call for a hunt group is not accepted by any member, the call is forwarded to the voicemail box for the hunt group. This requires the hunt group voicemail box to have been defined as the CFNA (call forwarding on no answer) destination of this hunt group.

**Working in a Team (Groups)**

Call Pickup Group, Group Call and Hunt Group

If a member does not accept an incoming call to his or her own station number, this call is redirected to a call forwarding destination in accordance with the call destination list.

Example of a linear hunt group with the call number 404 and the members A (call number 200), B (201) and C (202). Call Forwarding-No Answer after Timeout to the voicemail box of the hunt group was set up for the hunt group. Every member has defined Call Forwarding-No Answer (CFNA) after Timeout to his or her own voicemail box.		
Inbound call for Member A (200)	All members are free.	Member A does not accept the call. Call Forwarding-No Answer after Timeout occurs to the voicemail box of member A.
	Member A has defined Call Forwarding Unconditional (CFU) to his or her own voicemail box. Members B and C are free.	The call is forwarded immediately (CFU) to the voicemail box of member A.
Inbound call for the hunt group (404)	All members are free.	The call is signaled first at member A, then at member B and then at member C. No member accepts the call. Call Forwarding-No Answer after Timeout occurs to the voicemail box of the hunt group.
	Member A has defined Call Forwarding Unconditional (CFU) to his or her own voicemail box. Members B and C are free.	The call is signaled first at member B and then at member C. No member accepts the call. Call Forwarding-No Answer after Timeout occurs to the voicemail box of the hunt group.
	Member A has defined Call Forwarding Unconditional (CFU) to an external destination. Members B and C are free.	The call is signaled first at member B and then at member C. No member accepts the call. Call Forwarding-No Answer after Timeout occurs to the voicemail box of the hunt group.
	Member A has defined CFNA rules using the AutoAttendant. Members B and C are free.	The call is signaled first at member A, then at member B and then at member C. No member accepts the call. Call Forwarding-No Answer after Timeout occurs to the voicemail box of the hunt group.

**Activating/Deactivating the Hunt Group**

If a subscriber is a member of a hunt group, he or she can use codes to leave and rejoin the hunt group.

If a subscriber is a member of both multiple hunt groups and multiple group calls, he or she can use codes to leave and rejoin all hunt groups and group calls. Subscribers are added to or removed from a specific hunt group or group call by entering codes and then making a selection from the hunt groups and group calls displayed.

You can also program function keys with a shift function for joining and leaving. You can program a function key here that applies for a specific or all hunt groups



and group calls. Variable programming is also possible. After you press a function key of this kind, you must select one of the hunt groups and group calls displayed to define the hunt group or group call you want to leave/join.

### Ring type

For every hunt group, an administrator with the **Expert** profile can define the acoustic signaling of incoming external calls via the ring type setting. You have the following options:

- Two rings (default setting)
- Three rings
- short-long-short ring

Only the default setting is possible for analog phones. Changes have no effect.

### SIP Phones

SIP telephones can be integrated in a hunt group.

---

**INFO:** No programming of function keys is possible for SIP phones. Furthermore, no features can be activated or deactivated via codes. Specific display messages of a hunt group are not supported.

---

### Dependencies

Topic	Dependency
Call forwarding	If a hunt group member activates call forwarding for all calls, all calls are signaled at the destination telephone.
Do Not Disturb	If a hunt group member activates the Do Not Disturb feature, incoming calls for his or her phone are not put through. This applies to calls for the hunt group and the member's own station number.
Queue	For cyclical and linear hunt groups, it is not possible to set up a call queue.
ISDN Phones	It is not possible to include ISDN telephones in hunt groups.

---

### Related Topics

- [How to Add a Hunt Group](#)
- [How to Change a Hunt Group](#)
- [How to Delete a Hunt Group](#)
- [How to Add or Delete a Member to or from a Hunt Group](#)

## 14.1.4 Configuring Call Pickup Groups, Group Calls and Hunt Groups using Wizards

Several different wizards are available to conveniently configure call pickup groups, group calls and hunt groups.

The **Call Pickup** wizard can be used to combine subscribers into a group to enable mutual call pickups. The following application cases, which can be configured using the wizard, are described here:

- [How to Configure a Call Pickup Group](#)
- [How to Add or Delete a Member to or from a Call Pickup Group](#)

The **Group Call / Hunt Group** wizard can be used to configure group calls of the type Group. The following application cases, which can be configured using the wizard, are described here:

- [How to Add a Group Call \(Group\)](#)
- [How to Edit a Group Call \(Group\)](#)
- [How to Delete a Group Call \(Group\)](#)
- [How to Add or Delete a Member to or from a Group Call \(Group\)](#)
- [How to Add a Hunt Group](#)
- [How to Change a Hunt Group](#)
- [How to Delete a Hunt Group](#)
- [How to Add or Delete a Member to or from a Hunt Group](#)

### 14.1.4.1 How to Configure a Call Pickup Group

The **Call Pickup** wizard enables you to combine subscribers into a group so that they can accept calls for one another.

#### **Prerequisites**

- You are logged on to the WBM with the **Advanced** profile.

#### **Step by Step**

- 1) In the navigation bar, click on **Setup**.
- 2) In the navigation tree, click **Wizards > User Telephony**.
- 3) Click on **Edit** to start the **Call Pickup** wizard. The list of all possible call pickup groups is displayed.
- 4) To configure a call pickup group, click **Edit** in the row containing the required call pickup group.
- 5) If you want to add members to the call pickup group, enable the **Allocation Group <Number>** check boxes for the desired call numbers/names.

- 6) If you want to remove members from the call pickup group, clear the **Allocation Group <Number>** check boxes for the desired call numbers/ names.
- 7) Click on **OK** to accept the entries.
- 8) Enter the name of the just configured call pickup group in the **Name** field.
- 9) If you want to configure further call pickup groups, repeat steps 4 through 8.
- 10) Click on **OK & Next** followed by **Finish**.

---

**Related Topics**

- [Call Pickup Group](#)

### 14.1.4.2 How to Add or Delete a Member to or from a Call Pickup Group

The **Group Pickup** wizard can be used to add or delete members to or from call pickup groups.

**Prerequisites**

- You are logged on to the WBM with the **Advanced** profile.

**Step by Step**

- 1) In the navigation bar, click on **Setup**.
- 2) In the navigation tree, click **Wizards > User Telephony**.
- 3) Click on **Edit** to start the **Call Pickup** wizard.
- 4) Click **Edit** in row of the desired call pickup group.
- 5) Select one of the following options:
  - If you want to add members to the call pickup group, enable the **Allocation Group <Number>** check boxes for the desired call numbers/ names.
  - If you want to remove members from the call pickup group, clear the **Allocation Group <Number>** check boxes for the desired call numbers/ names.
- 6) Click on **OK** to confirm the entries.
- 7) Click on **OK & Next** followed by **Finish**.

---

**Related Topics**

- [Call Pickup Group](#)

### 14.1.4.3 How to Add a Group Call (Group)

The **Group Call / Hunt Group** wizard can be used to configure group calls of the type Group.

#### *Prerequisites*

- You are logged on to the WBM with the **Advanced** profile.

#### *Step by Step*

- 1) In the navigation bar, click on **Setup**.
- 2) In the navigation tree, click **Wizards > User Telephony**.
- 3) Click on **Edit** to start the **Group Call / Hunt Group** wizard.
- 4) Click on **Add** to set up a new group call.
- 5) Enter the call number of the new group call in the **Call number of the group** field.
- 6) Enter the DID number of the new group call in the **Direct inward dialing number** field.
- 7) Enter the name of the new group call in the **Name of the group** field.
- 8) Select the item **Group** in the **Type** drop-down list.
- 9) Select one of the following options to transfer the call number for the group call into the internal directory:
  - If you do want the call number of the group call to appear in the internal directory, enable the **Tel. directory** check box.
  - If you do not want the call number of the group call to appear in the internal directory, clear the **Tel. directory** check box.
- 10) Select the call number of the desired subscriber from the **Call number of the subscriber to be added to the group** drop-down list.
- 11) Click on **OK & Next**.

---

**INFO:** If the phone number and/or DID number you have selected already exists, you can call up the current dial plan (also called a numbering plan) to determine a free phone number and/or DID number.

---

- 12) Click **Edit** in the row containing the new group call to assign further subscribers to the group call.
- 13) Select the call number for the subscriber that you want to assign to the group call in the **Call No.** drop-down list.
- 14) Click on **Add**.
- 15) If you want to assign another subscriber to the group call, repeat steps 13 and 14.

- 16) Click on **OK** to accept the entries.
- 17) If you want to configure another group call, repeat steps 4 through 16.
- 18) Click on **OK & Next** followed by **Finish**.

---

**Related Topics**

- [Group Call](#)

#### 14.1.4.4 How to Edit a Group Call (Group)

The **Group Call / Hunt Group** wizard can be used to edit group calls of the type Group.

**Prerequisites**

- You are logged on to the WBM with the **Advanced** profile.

**Step by Step**

- 1) In the navigation bar, click on **Setup**.
- 2) In the navigation tree, click **Wizards > User Telephony**.
- 3) Click **Edit** to start the **Group Call / Hunt Group** wizard.
- 4) Click **Edit** in the row containing the group call you want to change.
- 5) Change the required group parameters.
- 6) Only with UC Smart: Assign a mailbox to the group call if needed:
  - a) Select whether the group call is to receive a default mailbox or an attendant mailbox (AutoAttendant) in the **UC Smart Mailbox type** drop-down list.
  - b) Only with default mailbox: If a caller may leave a message in the voicemail box, select the **Recording** check box.
  - c) Select a greeting from the **Greeting** drop-down list.
  - d) If the password of the voicemail box is to be reset, select the **Password Reset** check box.

---

**INFO:** The **Password Reset** check box must be cleared when setting up a new voicemail box. It is used to reset the password of the voicemail box. When a new voicemail box is created, the subscriber must change the initial password anyway when accessing his or her voicemail box for the first time.

---

- 7) If you want to add a member to the group call, select the call number of the desired subscriber from the **Call No.** drop-down list and then click **Add**.

## Working in a Team (Groups)

Call Pickup Group, Group Call and Hunt Group

- 8) If you want to remove a member from the group call, click on **Clear** in the row of the group member to be removed and then on **OK**.
- 9) Click **OK** to confirm the entries.
- 10) Click **OK & Next** followed by **Finish**.

---

### Related Topics

- [Group Call](#)

## 14.1.4.5 How to Delete a Group Call (Group)

The **Group Call / Hunt Group** wizard can be used to delete group calls of the type Group.

### *Prerequisites*

- You are logged on to the WBM with the **Advanced** profile.

### *Step by Step*

- 1) In the navigation bar, click on **Setup**.
- 2) In the navigation tree, click **Wizards > User Telephony**.
- 3) Click on **Edit** to start the **Group Call / Hunt Group** wizard.
- 4) Click **Edit** in the row containing the group call you want to delete.
- 5) Click on **Delete Data**.
- 6) Click on **OK** to confirm the deletion.
- 7) Click on **OK & Next** followed by **Finish**.

---

### Related Topics

- [Group Call](#)

## 14.1.4.6 How to Add or Delete a Member to or from a Group Call (Group)

The **Group Call / Hunt Group** wizard can be used to add or delete members to or from group calls of the type Group.

### *Prerequisites*

- You are logged on to the WBM with the **Advanced** profile.

### **Step by Step**

- 1) In the navigation bar, click on **Setup**.
- 2) In the navigation tree, click **Wizards > User Telephony**.
- 3) Click on **Edit** to start the **Group Call / Hunt Group** wizard.
- 4) Click on **Edit** in the row of the desired system telephone.
- 5) Select one of the following options:
  - If you want to add a member to the group call, select the call number of the desired subscriber from the **Call No.** drop-down list and then click **Add**.
  - If you want to remove a member from the group call, click on **Clear** in the row of the group member to be removed and then on **OK**.
- 6) Click on **OK** to confirm the entries.
- 7) Click on **OK & Next** followed by **Finish**.

---

### **Related Topics**

- [Group Call](#)

## **14.1.4.7 How to Add a Hunt Group**

The **Group Call / Hunt Group** wizard can be used to set up hunt groups.

### **Prerequisites**

- You are logged on to the WBM with the **Advanced** profile.

### **Step by Step**

- 1) In the navigation bar, click on **Setup**.
- 2) In the navigation tree, click **Wizards > User Telephony**.
- 3) Click on **Edit** to start the **Group Call / Hunt Group** wizard.
- 4) Click on **Add** to set up a new hunt group.
- 5) Enter the call number of the new hunt group in the **Call number of the group** field.
- 6) Enter the DID number of the new hunt group in the **Direct inward dialing number** field.
- 7) Enter the name of the new hunt group in the **Group Name** field.
- 8) Select the type of the new hunt group in the **Type** drop-down list. You have the following options:
  - If you want a call to always be signaled at the first member of the hunt group first, then select the item **linear hunt group**.

## Working in a Team (Groups)

Call Pickup Group, Group Call and Hunt Group

- If you want a call to always be signaled first at the hunt group member who follows the one who accepted the last call, select the item **cyclic hunt group**.
- 9) Select one of the following options to transfer the call number for the hunt group into the internal directory:
    - If you do want the call number of the hunt group to appear in the internal directory, enable the **Tel. directory** check box.
    - If you do not want the call number of the hunt group to appear in the internal directory, clear the **Tel. directory** check box.
  - 10) Select the call number of the desired subscriber from the **Call number of the subscriber to be added to the group** drop-down list.
  - 11) Click on **OK & Next**.

---

**INFO:** If the phone number and/or DID number you have selected already exists, you can call up the current dial plan (also called a numbering plan) to determine a free phone number and/or DID number.

---

- 12) Click **Edit** in the row containing the new hunt group to assign further subscribers to the hunt group.
- 13) Select the call number of the subscriber that you want to assign to the hunt group in the **Call No.** drop-down list.
- 14) Click on **Add**.
- 15) If you want to assign another subscriber to the hunt group, repeat steps 13 and 14.
- 16) Click on **OK** to accept the entries.
- 17) If you want to configure another hunt group, repeat steps 4 through 16.
- 18) Click on **OK & Next** followed by **Finish**.

---

### Related Topics

- [Hunt Group](#)

## 14.1.4.8 How to Change a Hunt Group

The **Group Call / Hunt Group** wizard can be used to edit hunt groups.

### Prerequisites

- You are logged on to the WBM with the **Advanced** profile.



### Step by Step

- 1) In the navigation bar, click on **Setup**.
- 2) In the navigation tree, click **Wizards > User Telephony**.
- 3) Click **Edit** to start the **Group Call / Hunt Group** wizard.
- 4) Click **Edit** in the row containing the hunt group you want to change.
- 5) Change the required hunt group parameters.
- 6) Only with UC Smart: Assign a mailbox to the hunt group if needed:
  - a) Select whether the hunt group is to receive a default mailbox or an attendant mailbox (AutoAttendant) in the **UC Smart Mailbox type** drop-down list.
  - b) Only with default mailbox: If a caller may leave a message in the voicemail box, select the **Recording** check box.
  - c) Select a greeting from the **Greeting** drop-down list.
  - d) If the password of the voicemail box is to be reset, select the **Password Reset** check box.

---

**INFO:** The **Password Reset** check box must be cleared when setting up a new voicemail box. It is used to reset the password of the voicemail box. When a new voicemail box is created, the subscriber must change the initial password anyway when accessing his or her voicemail box for the first time.

---

- 7) If you want to add a member to the hunt group, select the call number of the desired subscriber from the **Call No.** drop-down list and then click **Add**.
- 8) If you want to remove a member from the hunt group, click on **Clear** in the row of the group member to be removed and then on **OK**.
- 9) If you want to change the position of the members within the hunt group, click **Change Order**. Enter the desired position number for each member in the **Position** field. Click **OK & Next**.
- 10) Click **OK** to confirm the entries.
- 11) Click **OK & Next** followed by **Finish**.

---

#### Related Topics

- [Hunt Group](#)

### 14.1.4.9 How to Delete a Hunt Group

The **Group Call / Hunt Group** wizard can be used to delete hunt groups.

## Working in a Team (Groups)

Call Pickup Group, Group Call and Hunt Group

### *Prerequisites*

- You are logged on to the WBM with the **Advanced** profile.

### *Step by Step*

- 1) In the navigation bar, click on **Setup**.
- 2) In the navigation tree, click **Wizards > User Telephony**.
- 3) Click on **Edit** to start the **Group Call / Hunt Group** wizard.
- 4) Click **Edit** in the row containing the hunt group you want to delete.
- 5) Click on **Delete Data**.
- 6) Click on **OK** to confirm the deletion.
- 7) Click on **OK & Next** followed by **Finish**.

---

### **Related Topics**

- [Hunt Group](#)

## 14.1.4.10 How to Add or Delete a Member to or from a Hunt Group

The **Group Call / Hunt Group** wizard can be used to add or delete members to or from hunt groups.

### *Prerequisites*

- You are logged on to the WBM with the **Advanced** profile.

### *Step by Step*

- 1) In the navigation bar, click on **Setup**.
- 2) In the navigation tree, click **Wizards > User Telephony**.
- 3) Click on **Edit** to start the **Group Call / Hunt Group** wizard.
- 4) Click **Edit** in the row of the desired hunt group.
- 5) Select one of the following options:
  - If you want to add a member to the hunt group, select the call number of the desired subscriber from the **Call No.** drop-down list and then click **Add**.
  - If you want to remove a member from the hunt group, click on **Clear** in the row of the group member to be removed and then on **OK**.
- 6) Click on **OK** to confirm the entries.
- 7) Click on **OK & Next** followed by **Finish**.

---

**Related Topics**

- [Hunt Group](#)

## 14.1.5 Configuring Call Pickup Groups, Group Calls and Hunt Groups using Expert Mode

Besides the configuration options available through wizards, administrators with the **Expert** profile are also offered additional options to configure call pickup groups, group calls and hunt groups via the **Expert mode**.

The procedure for the following application cases, which can be configured using the **Expert mode** wizard, is described here:

- [How to Enable or Disable the Display of a Caller's Station Number and Name](#)
- [How to Activate or Deactivate the Warning Tone](#)
- [How to Enable or Disable Call Pickup for Recalls](#)
- [How to Add a Group Call \(RNA or Call Waiting\)](#)
- [How to Display or Edit a Group Call \(RNA or Call waiting\)](#)
- [How to Delete a Group Call \(RNA or Call Waiting\)](#)
- [How to Add or Delete a Member to or from a Group Call \(RNA or Call Waiting\)](#)
- [How to Enable or Disable Do Not Disturb for a Group Member](#)

### 14.1.5.1 How to Enable or Disable the Display of a Caller's Station Number and Name

#### *Prerequisites*

- You are logged into the WBM with the **Expert** profile.

#### *Step by Step*

- 1) In the navigation bar, click on **Expert Mode**.
- 2) Click **Telephony > Basic Settings** in the navigation tree.
- 3) In the menu tree, click on **System > System Flags**.
- 4) Select one of the following options:
  - If you do want the call number and name of the caller to be displayed, enable the **Calling number in pick-up groups / ringing groups / CFN / RNA** check box.
  - If you do not want the call number and name of the caller to be displayed, clear the **Calling number in pick-up groups / ringing groups / CFN / RNA** check box.
- 5) Click on **Apply** followed by **OK**.

## Working in a Team (Groups)

Call Pickup Group, Group Call and Hunt Group

---

### Related Topics

- [Call Pickup Group](#)

## 14.1.5.2 How to Activate or Deactivate the Warning Tone

### *Prerequisites*

- You are logged into the WBM with the **Expert** profile.

### *Step by Step*

- 1) In the navigation bar, click on **Expert Mode**.
- 2) Click **Telephony > Basic Settings** in the navigation tree.
- 3) In the menu tree, click on **System > System Flags**.
- 4) Select one of the following options:
  - If you want to activate the warning tone, enable the check box **Warning signal for call pickup groups**.
  - If you want to deactivate the warning tone, clear the check box **Warning signal for call pickup groups**.
- 5) Click on **Apply** followed by **OK**.

---

### Related Topics

- [Call Pickup Group](#)

## 14.1.5.3 How to Enable or Disable Call Pickup for Recalls

### *Prerequisites*

- You are logged into the WBM with the **Expert** profile.

### *Step by Step*

- 1) In the navigation bar, click on **Expert Mode**.
- 2) Click **Telephony > Basic Settings** in the navigation tree.
- 3) In the menu tree, click on **System > System Flags**.
- 4) Select one of the following options:
  - If you want to allow a call pickup for recalls, enable the check box **Call Pickup after automatic recall**.
  - If you do not want to allow a call pickup for recalls, clear the check box **Call Pickup after automatic recall**.

- 5) Click on **Apply** followed by **OK**.

---

**Related Topics**

- [Call Pickup Group](#)

#### 14.1.5.4 How to Add a Group Call (RNA or Call Waiting)

**Prerequisites**

- You are logged into the WBM with the **Expert** profile.

**Step by Step**

- 1) In the navigation bar, click on **Expert Mode**.
- 2) In the navigation tree, click **Telephony > Incoming Calls**.
- 3) Click **Incoming Calls > Groups/Hunt groups** in the menu tree.
- 4) Click on the **Add Group** tab.
- 5) Enter the call number of the new group call in the **Phone Number** field.
- 6) Enter the DID number of the new group call in the **Direct inward dialing number** field.
- 7) Enter the name of the new group call in the **Name** field.
- 8) Select one of the following options in the **Type** drop-down list:
  - If you want to set up a group call of type RNA (ring no answer), select the **RNA** entry.
  - If you want to set up a group call of type Call Waiting, select the **Call waiting** entry.
- 9) Select the call number for the subscriber that you want to assign to the group call from the **Phone Number** drop-down list.
- 10) Click on **Apply** followed by **OK**.

---

**Related Topics**

- [Group Call](#)

#### 14.1.5.5 How to Display or Edit a Group Call (RNA or Call waiting)

**Prerequisites**

- You are logged into the WBM with the **Expert** profile.

## Working in a Team (Groups)

Call Pickup Group, Group Call and Hunt Group

### *Step by Step*

- 1) In the navigation bar, click on **Expert Mode**.
- 2) In the navigation tree, click **Telephony > Incoming Calls**.
- 3) Navigate in the menu tree under **Incoming Calls > Groups/Hunt groups > ...** down to the desired group call.
- 4) Click on the **Edit Group Parameters** tab. The current settings of the group parameters are displayed.
- 5) Edit the desired parameters for the group call if required.
- 6) Click on **Apply** followed by **OK**.

---

#### **Related Topics**

- [Group Call](#)

### 14.1.5.6 How to Delete a Group Call (RNA or Call Waiting)

#### *Prerequisites*

- You are logged into the WBM with the **Expert** profile.

#### *Step by Step*

- 1) In the navigation bar, click on **Expert Mode**.
- 2) In the navigation tree, click **Telephony > Incoming Calls**.
- 3) Navigate in the menu tree under **Incoming Calls > Groups/Hunt groups > ...** down to the desired group call.
- 4) Click on the **Delete Group** tab.
- 5) Click on **Delete** followed by **OK**.

---

#### **Related Topics**

- [Group Call](#)

### 14.1.5.7 How to Add or Delete a Member to or from a Group Call (RNA or Call Waiting)

#### *Prerequisites*

- You are logged into the WBM with the **Expert** profile.

#### *Step by Step*

- 1) In the navigation bar, click on **Expert Mode**.
- 2) In the navigation tree, click **Telephony > Incoming Calls**.

- 3) Select one of the following options:
  - To add a member to the group call, navigate in the menu tree under **Incoming Calls > Groups/Hunt groups > ...** down to the desired group call. Then click on the **Add member** tab. Select the call number of the desired station in the **Phone Number** drop-down list. Then click **Apply**, followed by **OK**.
  - To remove a member from the group call, navigate in the menu tree under **Incoming Calls > Groups/Hunt groups > ...** down to the desired member of the group call ((Group Member) Call No, Name). Click on the **Delete Member** tab. Click on **Delete** followed by **OK**.

---

**Related Topics**

- [Group Call](#)

### 14.1.5.8 How to Enable or Disable Do Not Disturb for a Group Member

**Prerequisites**

- You are logged into the WBM with the **Expert** profile.

**Step by Step**

- 1) In the navigation bar, click on **Expert Mode**.
- 2) In the navigation tree, click on **Telephony > Stations**.
- 3) Navigate in the menu tree under **Stations > Station > ...** down to the desired station (Index - Station Number - Name).
- 4) Click on the **Edit Station Flags** tab.
- 5) Select one of the following options:
  - If you want to enable the Do Not Disturb feature, select the check box **Call waiting rejection on**.
  - If you want to disable the Do Not Disturb feature, clear the **Call waiting rejection on** check box.

---

**INFO:** When a group is configured as an Attendant group, all its' existing members are automatically set with the "Call waiting rejection flag" switched to false. This also applies to any new members of the Attendant group. The user can manually set "Call waiting rejection on" to true to any of the Attendant group's members in order to enable busy tone for this member, but this is not the default behavior.

---

- 6) Click on **Apply** followed by **OK**.

---

**Related Topics**

- [Group Call](#)

## 14.2 Team Configuration / Team Group and Executive/Secretary / Top Group

A Team Configuration / Team Group offers several convenient team functions. The station numbers of all team members are programmed on MULAP keys (trunk keys). Every team member can thus access all trunks (for instance, for call pickup) and can also conduct calls simultaneously via multiple trunks. An Executive/Secretary or Top Group offers convenient Executive and Secretary functions (Top function) for up to three executives and up to three secretaries.

---

**INFO:** When creating a MULAP from Team/Top options in WBM / Manager E it is not allowed to enter any number beginning with \*\* or \*\*\*.

---

### 14.2.1 Team Configuration / Team Group

MULAP (Multiple Line Appearance) keys (trunk keys) are programmed on a telephone with team functions with the individual telephone's number and the phone numbers of all other team members. Every team member can access all trunks (for instance, for call pickup) and can also conduct calls simultaneously via multiple trunks. In addition, DSS keys with which the team members can directly call one another are programmed automatically.

The MULAP keys give team members access to the phone numbers of all members. An incoming call for a team member can thus also be accepted by all other members by pressing the flashing MULAP key. Team members can also toggle between multiple trunks. By pressing a MULAP key, a team member can make an outbound call via the associated line. The station number of this line will then appear on the display of the called party.

Incoming calls are visually signaled at the same time on all team member phones via the MULAP key LED. You can also specify for each team member if incoming calls should also be signaled acoustically.

Every team member can use a group call key to activate or deactivate incoming call signaling for each individual trunk.

An administrator with the **Advanced** profile can configure up to 3 stations per Team configuration/Team group by using the **Team Configuration** wizard. An administrator with the **Expert** profile can configure up to ten stations per Team configuration or Team group in **Expert mode**.

A single subscriber may also simultaneously belong to several groups. The following applies to groups of the type Group Call, Hunt Group, Team



Configuration / Team Group and Executive/Secretary / Top Group: The sum of all the subscriber's memberships in these groups must not exceed 32.

Every team configuration / team group can be assigned a name containing up to 16 characters.

When setting up a Team configuration or Team group, the following properties are assigned to its members (these settings can be changed by an administrator with the **Expert** profile in **Expert mode**):

- **Master**  
This parameter changes a member into a master of the Team configuration / Team group. If a master activates call forwarding, this applies to all members (phones) in the Team configuration / Team group.  
Default setting: master is the first member of the Team configuration / Team group.
- **Acoustic ring**  
If this parameter is activated, incoming calls are signaled acoustically.  
Default setting: the parameter is activated.
- **Automatic seizure outgoing**  
If this parameter is active, a call is automatically made via the MULAP trunk of this member on lifting the handset. If the parameter is not active, the subscriber must press the MULAP key before dialing is possible.  
Default setting: the parameter is activated.
- **No automatic incoming call acceptance**  
If this parameter is activated, you cannot answer an incoming call by lifting the handset. An incoming call must be accepted by pressing the MULAP key.  
Default setting: the parameter is not activated.
- **Automatic conference release**  
If the parameter is active, you can release the seized MULAP line for a conference by pressing the MULAP key. The release of this line is signaled to all other members by the flashing MULAP key. They can join the conference by pressing the MULAP key.  
Default setting: the parameter is not activated.
- **MULAP key set up**  
If the parameter is active, a MULAP key is programmed on the associated phone. Pressing the key sets up an outgoing call via the MULAP trunk of the master. The MULAP station number of the master appears on the called party's display.  
Default setting: the parameter is not activated.

### Using MULAP Keys

Every team member is assigned a separate trunk (MULAP trunk). The member's own trunk and the trunks of all other members are programmed as MULAP keys (trunk keys) for every team member. This means that every team can use all available MULAP trunks.

The LED on a MULAP key (trunk key) can have different statuses with the following meaning:

- Off: the relevant trunk is free and can be used.
- Lit: the relevant trunk is busy.

## Working in a Team (Groups)

Team Configuration / Team Group and Executive/Secretary / Top Group

- Flashing fast: call on the relevant trunk.
- Flashing slow: an on-hold call is waiting on the relevant trunk.

### Using DSS Keys

Every team member has a DSS key for every other team member. This means that team members can reach each other directly at the push of a button.

A Direct Station Select (DSS) key can also be used to quickly transfer an existing call to the team member programmed on it.

The LED on a DSS key can have different statuses with the following meanings:

- Off: the associated Team member is not conducting a call.
- Lit: the associated Team member is conducting a call or has activated Do Not Disturb.
- Flashing fast: the associated Team member is conducting a call. The call can be accepted by pressing the Direct Station Select (DSS) key.
- Flashing slowly: the associated Team member is being called and has not yet answered. The call can be accepted by pressing the Direct Station Select (DSS) key.

### Ring type

For every Team configuration / Team group, an administrator with the **Expert** profile can define the acoustic signaling of incoming external calls via the ring type setting. You have the following options:

- Two rings (default setting)
- Three rings
- short-long-short ring

Only the default setting is possible for analog phones. Changes have no effect.

### Fax Box for Team Configuration / Team Group

For each Team configuration or Team group, a fax box can be set up via which the members can receive Fax messages directly through myPortal for Desktop or myPortal for Outlook.

If a fax box was already configured for the master (the first member) of the Team configuration/Team group, this fax box is taken over when setting up the Team configuration/Team group. Previously configured fax boxes of other members are deleted.

After a Team configuration or Team group is dissolved, only the prior master (i.e., the first member) can use his or her fax box.

### SIP Phones

SIP telephones can be integrated in a Team configuration / Team group. As a prerequisite, a system telephone (IP, HFA or SIP phone, for example) must have been defined as the first member of the Team configuration / Team group.

Dual-mode mobile phones that are configured as Mobility Entry stations, for example, can be integrated. Dual-mode mobile phones support both GSM/UMTS

networks and WLAN networks. A dual-mode mobile phone can be registered as an IP station (SIP client) at the communication system over a WLAN.

---

**INFO:** No programming of MULAP keys and DSS keys is possible for SIP phones. Furthermore, no features can be activated or deactivated via codes. Specific display messages of the Team configuration / Team group are not supported.

---

### Dependencies

Topic	Dependency
Call forwarding	One team member has activated call forwarding for all calls. In this case, all calls for his or her own station number will be forwarded.
Do Not Disturb	If a Team member activates the Do Not Disturb feature, incoming calls are not put through.
ISDN Phones	It is not possible to include ISDN telephones in Team configurations / Team groups.
Groups/Hunt groups	It is not possible to include a Basic/Executive MULAP master in Team configurations / Team groups.

## 14.2.2 Executive/Secretary or Top Group

Top groups can be configured if you need user-friendly executive and secretary functions (Top function).

Executive/secretary functions can be configured for groups with up to three executives and up to three secretaries.

---

**INFO:** The terms "executive" and "secretary" also apply to groups with more than one executive and more than one secretary. The terms "executive" and "secretary" used in this document are gender-neutral.

---

Every Top member (every executive and every secretary) is assigned a separate trunk, known as a MULAP (Multiple Line Appearance) trunk. The member's own MULAP trunk and the MULAP trunks of all other members are programmed as MULAP keys (trunk keys) for every Top member. The MULAP phone number is shown on the called party's display for outgoing calls via the MULAP trunk. The Secretary station can make calls via its own trunk or the MULAP trunk of all executives and other secretary stations. For example, if a connection is to be set up for an executive, the MULAP trunk of that executive can be used.

DSS keys are also programmed to allow the executive to call the secretary directly, and vice versa.

## Working in a Team (Groups)

Team Configuration / Team Group and Executive/Secretary / Top Group

Incoming calls are visually signaled at the same time on all Top member phones via the LED on the trunk key. You can also specify for each Top member if incoming calls should also be signaled acoustically. Acoustic signaling depends here on the ring transfer key.

You can use a ring transfer key to change the signaling for incoming calls. Incoming calls are signaled either at the executive or secretary phone. If the executive presses the ring transfer key, incoming calls will still be displayed to the executive via a tray pop. Accepting a call can, however, only be done via an appropriate key on the phone and not via the tray pop.

You can use a group call key on Secretary phones to add or remove the station to or from the Executive/Secretary configuration or Top group. In this case, ring transfer has priority.

---

**INFO:** If the secretary uses the group call key to leave the Executive/Secretary configuration or Top group without activating ring transfer for the executive, incoming calls are not signaled at either the executive or the secretary.

---

An administrator with the **Advanced** profile can define up to two executives and two secretaries per Executive/Secretary configuration or Top group using the **Executive/Secretary** wizard. An administrator with the **Expert** profile can define up to three executives and three secretaries per Executive/Secretary configuration or Top group in **Expert mode**.

For every executive, a maximum of three phones can be set up; for every secretary, a maximum of two phones.

An single subscriber may also simultaneously belong to several groups. The following applies to groups of the type Group Call, Hunt Group, Team Configuration / Team Group and Executive/Secretary / Top Group: The sum of all the subscriber's memberships in these groups must not exceed 32.

Every Executive/Secretary configuration or Top group can be assigned a name containing up to 16 characters.

When setting up an Executive/Secretary configuration or Top group, the following properties are assigned to its members (these settings can be changed by an administrator with the **Expert** profile in **Expert mode**):

- **Master**  
This parameter assigns executive functions to a member. The Executive MULAP trunk is automatically selected for a call on lifting the handset. Incoming calls via the associated Executive MULAP phone number are only signaled visually by default.  
Default setting: All executives of the Executive/Secretary configuration or Top group receive Executive functions.
- **Acoustic ring**  
If this parameter is activated, incoming calls are signaled acoustically.  
Default setting: the parameter is active for all members with the secretary function.

- **Automatic seizure outgoing**  
If this parameter is active, a call is automatically made via the MULAP trunk of this member on lifting the handset. If the parameter is not active, the subscriber must press the MULAP key before dialing is possible.  
Default setting: the parameter is activated for all members.
- **No automatic incoming call acceptance**  
If this parameter is activated, you cannot answer an incoming call by lifting the handset. An incoming call must be accepted by pressing the MULAP key.  
Default setting: the parameter is not activated.
- **Automatic conference release**  
If the parameter is active, you can release the seized MULAP line for a conference by pressing the MULAP key. The release of this line is signaled to all other members by the flashing MULAP key. They can join the conference by pressing the MULAP key.  
Default setting: the parameter is not activated.
- **MULAP key set up**  
If the parameter is active, a MULAP key is programmed on the associated phone. You can press the key to set up an outgoing call via the Executive MULAP trunk. The Executive MULAP phone number appears on the called party's display.  
Default setting: the parameter is activated.

### Using MULAP Keys

Every Top member is assigned a separate trunk (MULAP trunk). The member's own trunk and the trunks of all other members are programmed as MULAP keys (trunk keys) for every Top member. This means that every Top member can use all available MULAP lines.

The LED on a MULAP key (trunk key) can have different statuses with the following meaning:

- Off: the relevant trunk is free and can be used.
- Lit: the relevant trunk is busy.
- Flashing fast: call on the relevant trunk.
- Flashing slowly: an on-hold call is waiting on the relevant trunk or the relevant trunk was released for a conference.

### Using DSS Keys

Every Top member has a DSS key for every other Top member. This means that Top members can reach each other directly at the push of a button.

A Direct Station Select (DSS) key can also be used to quickly transfer an existing call to the Top member programmed on it.

The LED on a DSS key can have different statuses with the following meanings:

- Off: The associated Top member is not conducting a call.
- Lit: the associated Top member is conducting a call or has activated Do Not Disturb.
- Flashing fast: the associated Top member is conducting a call. The call can be accepted by pressing the Direct Station Select (DSS) key.

## Working in a Team (Groups)

Team Configuration / Team Group and Executive/Secretary / Top Group

- Flashing slowly: the associated Top member is being called and has not yet answered. The call can be accepted by pressing the Direct Station Select (DSS) key.

### Ring type

For every Executive/Secretary configuration or Top group, an administrator with the **Expert** profile can define the acoustic signaling of incoming external calls via the ring type setting. You have the following options:

- Two rings (default setting)
- Three rings
- short-long-short ring

Only the default setting is possible for analog phones. Changes have no effect.

### Fax Boxes for Executive/Secretary Configuration or Top Group

For each member of an Executive/Secretary configuration or Top group, a fax box can be set up via which the members can receive Fax messages directly through myPortal for Desktop or myPortal for Outlook.

If a fax box was already configured for the first executive of the Executive/Secretary configuration or Top group, this fax box is taken over when setting up the Executive/Secretary configuration or Top group. Previously configured fax boxes of other members are deleted.

After an Executive/Secretary configuration or Top group is dissolved, only the prior first executive can use his or her fax box.

### SIP Phones

SIP telephones can be integrated in an Executive/Secretary configuration or Top group. As a prerequisite, a system telephone (IP, HFA or SIP phone, for example) must have been defined as the first member of the Executive/Secretary configuration or Top group (Exec. 1).

Dual-mode mobile phones that are configured as Mobility Entry stations, for example, can be integrated. Dual-mode mobile phones support both GSM/UMTS networks and WLAN networks. A dual-mode mobile phone can be registered as an IP station (SIP client) at the communication system over a WLAN.

---

**INFO:** No programming of MULAP keys and DSS keys is possible for SIP phones. Furthermore, no features can be activated or deactivated via codes. Specific display messages of the Executive/Secretary configuration / Top group are not supported.

---

### Dependencies

Topic	Dependency
Call forwarding	A Top member has activated call forwarding for all calls. In this case, all calls for his or her own station number will be forwarded.
Do Not Disturb	If a Top member activates the Do Not Disturb feature, incoming calls are not put through.
ISDN Phones	It is not possible to include ISDN or SIP phones in Executive/Secretary configurations or Top groups.
Groups/Hunt groups	It is not possible to include a Basic/Executive MULAP master in Executive/Secretary configurations or Top groups.

## 14.2.3 Configuring Team Configurations / Team Groups and Executive/Secretary Functions / Top Groups using Wizards

Several different wizards are available to conveniently configure team configurations (team groups) and executive/secretary functions (top groups).

The **Team Configuration** wizard can be used to set up Team configurations (Team groups). The following application cases, which can be configured using the wizard, are described here:

- [How to Add a Team Configuration / Team Group](#)
- [How to Edit a Team Configuration / Team Group](#)
- [How to Delete a Team Configuration / Team Group](#)

The **Executive / Secretary** wizard can be used to configure convenient Executive and Secretary functions (Top function). The following application cases, which can be configured using the wizard, are described here:

- [How to Add an Executive/Secretary or Top Group](#)
- [How to Edit an Executive/Secretary or Top Group](#)
- [How to Delete an Executive / Secretary or Top Group](#)

### 14.2.3.1 How to Add a Team Configuration / Team Group

The **Team Configuration** wizard can be used to create Team configurations (Team groups).

#### **Prerequisites**

- You are logged on to the WBM with the **Advanced** profile.

### Step by Step

- 1) In the navigation bar, click on **Setup**.
- 2) In the navigation tree, click **Wizards > User Telephony**.
- 3) Click on **Edit** to start the **Team Configuration** wizard.
- 4) Click on **Add** to set up a new team configuration.
- 5) Select the station number of the first telephone of the Team configuration in the **First Telephone** drop-down list.
- 6) Click on **OK & Next**.
- 7) In the **Name** field, enter the name of the new team configuration if no name is displayed or if you want to change the displayed name.  

Note: The **Name** field will already be preset with the name of the first telephone in the team configuration, provided a name was assigned to that telephone.
- 8) Enter the internal call number of the new team configuration in the **Internal Call Number** field if the displayed call number needs to be changed.  

Note: The **Internal Number** field is already preset with the internal station number of the first telephone of the team configuration.
- 9) Enter the DID number of the new team configuration in the **Direct inward dialing number** field if the displayed DID number needs to be changed.  

Note: The **Direct inward dialing number** field is already preset with the DID number of the first telephone of the team configuration.
- 10) Enter the internal number of the fax box for the new Team configuration under **Fax** in the **Internal Number** field if no call number is displayed or if the displayed call number needs to be changed.  

The **Internal Number** field will be preset with the internal number of the fax box of the first phone in the Team configuration if a fax box has already been configured for that phone.
- 11) Enter the DID number of the fax box for the new Team configuration under **Fax** in the **Direct inward dialing number** field if no DID number is displayed or if the displayed DID number needs to be changed.  

The **Direct inward dialing number** field will be preset with the DID number of the fax box of the first phone in the Team configuration if a fax box has already been configured for that phone.
- 12) Select the station number of the second telephone of the new Team configuration from the **Second Telephone** drop-down list.
- 13) Select the station number of the third telephone of the Team configuration from the **Third Telephone** drop-down list.
- 14) Click on **OK & Next**.
- 15) If you want to configure another Team configuration, repeat steps 4 through 14.
- 16) Click on **OK & Next** followed by **Finish**.



### 14.2.3.2 How to Edit a Team Configuration / Team Group

The **Team Configuration** wizard can be used to edit Team configurations (Team groups).

#### *Prerequisites*

- You are logged on to the WBM with the **Advanced** profile.

#### *Step by Step*

- 1) In the navigation bar, click on **Setup**.
- 2) In the navigation tree, click **Wizards > User Telephony**.
- 3) Click **Edit** to start the **Team Configuration** wizard.
- 4) Click **Edit** in the row of the team configuration you want to change.
- 5) Change the required parameters.
- 6) Only with UC Smart: Assign a mailbox to the team configuration if needed:
  - a) Select whether the team configuration is to receive a default mailbox or an attendant mailbox (AutoAttendant) in the **UC Smart Mailbox type** drop-down list.
  - b) Only with default mailbox: If a caller may leave a message in the voicemail box, select the **Recording** check box.
  - c) Select a greeting from the **Greeting** drop-down list.
  - d) If the password of the voicemail box is to be reset, select the **Password Reset** check box.

---

**INFO:** The **Password Reset** check box must be cleared when setting up a new voicemail box. It is used to reset the password of the voicemail box. When a new voicemail box is created, the subscriber must change the initial password anyway when accessing his or her voicemail box for the first time.

---

- 7) Click **OK & Next**.
- 8) Click on **OK & Next** followed by **Finish**.

### 14.2.3.3 How to Delete a Team Configuration / Team Group

The **Team Configuration** wizard can be used to delete Team configurations (Team groups).

#### *Prerequisites*

- You are logged on to the WBM with the **Advanced** profile.

## Working in a Team (Groups)

Team Configuration / Team Group and Executive/Secretary / Top Group

### Step by Step

- 1) In the navigation bar, click on **Setup**.
- 2) In the navigation tree, click **Wizards > User Telephony**.
- 3) Click on **Edit** to start the **Team Configuration** wizard.
- 4) Click **Edit** in the row of the team configuration you want to delete.
- 5) Click on **Delete Data**.
- 6) Click on **OK** to confirm the deletion.
- 7) Click on **OK & Next** followed by **Finish**.

---

**INFO:** In applications using CSTA interface (UC, OSCC, etc.) when a Team Group or a member of a Team Group is deleted, a system restart is needed.

---

### 14.2.3.4 How to Add an Executive/Secretary or Top Group

The **Executive / Secretary** wizard can be used to configure user-friendly executive and secretary functions (Top function).

#### Prerequisites

- You are logged on to the WBM with the **Advanced** profile.

#### Step by Step

- 1) In the navigation bar, click on **Setup**.
- 2) In the navigation tree, click **Wizards > User Telephony**.
- 3) Click on **Edit** to start the **Executive / Secretary** wizard.
- 4) Click on **Add** to set up a new Executive/Secretary configuration (Top group).
- 5) Enter the name of the new Executive/Secretary configuration in the **Name** field.
- 6) Select the desired call numbers for the new Executive/Secretary configuration in the associated drop-down lists.
- 7) Click on **OK & Next**.
- 8) Enter the internal number of the fax box for the new Executive/Secretary configuration under **Fax** in the **Call No.** field if no call number is displayed or if the displayed call number needs to be changed.

The **Call No.** field will be preset with the internal number of the fax box of the first executive in the Executive/Secretary configuration if a fax box has already been configured for this phone.

- 9) Enter the DID number of the fax box for the new Executive/Secretary configuration under **Fax** in the **DID** field if no DID number is displayed or if the displayed direct inward dialing number needs to be changed.

The **Direct inward dialing** field will be preset with the DID number of the fax box of the first executive in the Executive/Secretary configuration if a fax box has already been configured for this phone.

- 10) Select a default for the key assignment:

- If the keys for the Executive/Secretary functions are to be set up on the first or second add-on device, enable the check box **to first/second console**.
- If the keys for the Executive/Secretary functions are to be set up on the first free function keys of the telephone, enable the check box **to first free key**.

- 11) Click on **OK & Next**.

- 12) If you want to configure another Executive/Secretary configuration, repeat steps 4 through 11.

- 13) Click on **OK & Next** followed by **Finish**.

### 14.2.3.5 How to Edit an Executive/Secretary or Top Group

The **Executive / Secretary** wizard can be used to edit convenient Executive and Secretary functions (Top function).

#### *Prerequisites*

- You are logged on to the WBM with the **Advanced** profile.

#### *Step by Step*

- 1) In the navigation bar, click on **Setup**.
- 2) In the navigation tree, click **Wizards > User Telephony**.
- 3) Click **Edit** to start the **Executive / Secretary** wizard.
- 4) Click **Edit** in the row containing the Executive/Secretary configuration you want to change.
- 5) Change the required parameters.
- 6) Only with UC Smart: Assign a mailbox to the Top Group if needed:
  - a) Select whether the Top Group is to receive a default mailbox or an attendant mailbox (AutoAttendant) in the **UC Smart Mailbox type** drop-down list.
  - b) Only with default mailbox: If a caller may leave a message in the voicemail box, select the **Recording** check box.
  - c) Select a greeting from the **Greeting** drop-down list.

## Working in a Team (Groups)

Team Configuration / Team Group and Executive/Secretary / Top Group

- d) If the password of the voicemail box is to be reset, select the **Password Reset** check box.

---

**INFO:** The **Password Reset** check box must be cleared when setting up a new voicemail box. It is used to reset the password of the voicemail box. When a new voicemail box is created, the subscriber must change the initial password anyway when accessing his or her voicemail box for the first time.

---

- 7) Click **OK & Next**.
- 8) Edit the desired entries for the fax box (**Fax**) and the **Key assignment**.
- 9) Click **OK & Next**.
- 10) Click **OK & Next** followed by **Finish**.

### 14.2.3.6 How to Delete an Executive / Secretary or Top Group

The **Executive / Secretary** wizard can be used to delete convenient Executive and Secretary functions (Top function).

#### *Prerequisites*

- You are logged on to the WBM with the **Advanced** profile.

#### *Step by Step*

- 1) In the navigation bar, click on **Setup**.
- 2) In the navigation tree, click **Wizards > User Telephony**.
- 3) Click on **Edit** to start the **Executive / Secretary** wizard.
- 4) Click **Edit** in the row containing the Executive/Secretary configuration (Top group) you want to delete.
- 5) Click on **Delete Data**.
- 6) Click on **OK** to confirm the deletion.
- 7) Click on **OK & Next** followed by **Finish**.

---

**INFO:** In applications using CSTA interface (UC, OSCC, etc.) when an Executive/Secretary or Top group or a member of an Executive/Secretary or Top group is deleted, a system restart is needed.

---

## 14.2.4 Configuring Team configurations / Team groups and Executive/Secretary functions / Top groups using Expert mode

Besides the configuration options available through wizards, administrators with the **Expert** profile are also offered additional options to configure Team configurations / Team groups and Executive/Secretary functions / Top groups via the **Expert mode**.

The procedure for the following application cases, which can be configured using the **Expert mode** wizard, is described here:

- [How to Add or Delete a Member to or from a Team Configuration or Team Group](#)
- [How to Edit a Member of a Team Configuration / Team Group](#)
- [How to Edit the Properties of Members in a Team Group](#)
- [How to Change the Programmed Feature Keys for a Team Configuration / Team Group](#)
- [How to Add a Fax Box to a Team Configuration / Team Group](#)
- [How to Add or Delete a Member to or from an Executive/Secretary or Top Group](#)
- [How to Edit a Member of an Executive/Secretary or Top Group](#)
- [How to Edit the Properties of an Executive/Secretary or Top Group](#)
- [How to Add a Fax Box to an Executive/Secretary or Top Group](#)

### 14.2.4.1 How to Add or Delete a Member to or from a Team Configuration or Team Group

#### **Prerequisites**

- You are logged into the WBM with the **Expert** profile.

---

**INFO:** The **Team Configuration** wizard can be used by an administrator with the **Advanced** profile to define up to three members (phones) for a Team configuration (Team group). Additional members must be added by an administrator with the **Expert** profile in **Expert mode** (see the description below).

---

#### **Step by Step**

- 1) In the navigation bar, click on **Expert Mode**.
- 2) In the navigation tree, click **Telephony > Incoming Calls**.
- 3) Select one of the following options:
  - To add a member to the Team group, navigate in the menu tree under **Incoming Calls > Team/top > ...** down to the desired Team group. Click on the **Add Team/top Member** tab. Select the station type in the **Type**

## Working in a Team (Groups)

Team Configuration / Team Group and Executive/Secretary / Top Group

drop-down list and select the call number of the desired station in the **Call No.** drop-down list. Then click **Apply**, followed by **OK**.

- To remove a member from the Team group, navigate in the menu tree under **Incoming Calls > Team/top > ...** down to the desired member of the Team group (Group Member, Call No, Name). Click on the **Delete Team/top Member** tab. Click on **Delete** followed by **OK**.

### 14.2.4.2 How to Edit a Member of a Team Configuration / Team Group

#### *Prerequisites*

- You are logged into the WBM with the **Expert** profile.

#### *Step by Step*

- 1) In the navigation bar, click on **Expert Mode**.
- 2) In the navigation tree, click **Telephony > Incoming Calls**.
- 3) Navigate in the menu tree under **Incoming Calls > Team/top > ...** down to a member of the Team group ((Group member) Station Number, Name).
- 4) Click on the **Edit Team/Top Member** tab.
- 5) Change the required parameters.
- 6) Click on **Apply** followed by **OK**.

### 14.2.4.3 How to Edit the Properties of Members in a Team Group

#### *Prerequisites*

- You are logged into the WBM with the **Expert** profile.

#### *Step by Step*

- 1) In the navigation bar, click on **Expert Mode**.
- 2) In the navigation tree, click **Telephony > Incoming Calls**.
- 3) Navigate in the menu tree under **Incoming Calls > Team/top > ...** down to a member of the Team group ((Group member) Station Number, Name).
- 4) Click on the **Edit Team/Top Group Parameters** tab.
- 5) Change the required properties.
- 6) Click on **Apply** followed by **OK**.

#### 14.2.4.4 How to Change the Programmed Feature Keys for a Team Configuration / Team Group

##### *Prerequisites*

- You are logged into the WBM with the **Expert** profile.

##### *Step by Step*

- 1) In the navigation bar, click on **Expert Mode**.
- 2) In the navigation tree, click **Telephony > Incoming Calls**.
- 3) Navigate in the menu tree under **Incoming Calls > Team/top > ...** down to the desired Team group).
- 4) Click on the **Edit Team/top Group** tab.
- 5) Select a default for the key assignment:
  - If the keys are to be set up on the first or second add-on device, enable the check box **to first/second console**.
  - If the keys are to be set up on the first free function keys of the telephone, enable the check box **to first free key**.
- 6) Click on **Apply** followed by **OK**.

#### 14.2.4.5 How to Add a Fax Box to a Team Configuration / Team Group

##### *Prerequisites*

- You are logged into the WBM with the **Expert** profile.

##### *Step by Step*

- 1) In the navigation bar, click on **Expert Mode**.
- 2) In the navigation tree, click **Telephony > Incoming Calls**.
- 3) Navigate in the menu tree under **Incoming Calls > Team/top > ...** down to the desired Team group).
- 4) Click on the **Add Fax Box** tab.
- 5) Enter the internal call number of the fax box in the **Fax No.** field of the desired Team group member.
- 6) Enter the direct inward dialing number of the fax box in the **Fax DID** field of the desired Team group member.
- 7) Click on **Apply** followed by **OK**.

## 14.2.4.6 How to Add or Delete a Member to or from an Executive/Secretary or Top Group

### Prerequisites

- You are logged into the WBM with the **Expert** profile.

---

**INFO:** The **Executive / Secretary** wizard can be used by an administrator with the **Advanced** profile to define up to two executives and two secretaries per Executive/Secretary configuration (Top group). Additional members must be added by an administrator with the **Expert** profile in **Expert mode** (see the description below).

---

### Step by Step

- 1) In the navigation bar, click on **Expert Mode**.
- 2) In the navigation tree, click **Telephony > Incoming Calls**.
- 3) Select one of the following options:
  - To add a member to the Top group (Executive/Secretary configuration), navigate in the menu tree under **Incoming Calls > Team/top > ...** down to the desired Top group (Executive/Secretary configuration). Click on the **Add Team/top Member** tab. Select the station type in the **Type** drop-down list and select the call number of the desired station in the **Call No.** drop-down list. Then click **Apply**, followed by **OK**.
  - To remove a member from the Top group (Executive/Secretary configuration), navigate in the menu tree under **Incoming Calls > Team/top > ...** down to the desired member of the Top group (Executive/Secretary configuration) (Group Member, Call No, Name). Click on the **Delete Team/top Member** tab. Click on **Delete** followed by **OK**.

## 14.2.4.7 How to Edit a Member of an Executive/Secretary or Top Group

### Prerequisites

- You are logged into the WBM with the **Expert** profile.

### Step by Step

- 1) In the navigation bar, click on **Expert Mode**.
- 2) In the navigation tree, click **Telephony > Incoming Calls**.
- 3) Navigate in the menu tree under **Incoming Calls > Team/Top > ...** down to a member of the Top group (Executive/Secretary configuration) ((Group member) Station Number, Name).
- 4) Click on the **Edit Team/Top Member** tab.
- 5) Change the required parameters.



- 6) Click on **Apply** followed by **OK**.

#### 14.2.4.8 How to Edit the Properties of an Executive/Secretary or Top Group

##### *Prerequisites*

- You are logged into the WBM with the **Expert** profile.

##### *Step by Step*

- 1) In the navigation bar, click on **Expert Mode**.
- 2) In the navigation tree, click **Telephony > Incoming Calls**.
- 3) Navigate in the menu tree under **Incoming Calls > Team/Top > ...** down to a member of the Top group (Executive/Secretary configuration) ((Group member) Station Number, Name).
- 4) Click on the **Edit Team/Top Group Parameters** tab.
- 5) Change the required properties.
- 6) Click on **Apply** followed by **OK**.

#### 14.2.4.9 How to Add a Fax Box to an Executive/Secretary or Top Group

##### *Prerequisites*

- You are logged into the WBM with the **Expert** profile.

##### *Step by Step*

- 1) In the navigation bar, click on **Expert Mode**.
- 2) In the navigation tree, click **Telephony > Incoming Calls**.
- 3) Navigate in the menu tree under **Incoming Calls > Team/top > ...** down to the desired Top group (Executive/Secretary configuration).
- 4) Click on the **Add Fax Box** tab.
- 5) Enter the internal call number of the fax box in the **Fax No.** field of the desired Top group (or Executive/Secretary configuration) member.
- 6) Enter the direct inward dialing number of the fax box in the **Fax No.** field of the desired Top group (or Executive/Secretary configuration) member.
- 7) Click on **Apply** followed by **OK**.

### 14.3 Basic MULAP and Executive MULAP

A Basic MULAP enables a subscriber who uses multiple telephones (e.g., a fixed-network telephone and a mobile phone) to be reached under a single phone

number. You can configure Executive MULAPs if you want to use restricted executive and secretary functions.

### 14.3.1 Basic MULAP

Basic MULAPs can be configured if a subscriber is using a number of different phones (for example, a fixed-network phone and mobile phone) but would like to be reached at a single phone number (Basic MULAP phone number).

If a caller rings the Basic MULAP phone number, the call is visually signaled at all phones belonging to the Basic MULAP. The subscriber can also set whether or not incoming calls should also be acoustically signaled for each individual member. The status of the Basic MULAP changes to busy and other callers hear the busy signal when a call is answered.

The Basic MULAP phone number is shown on the called party's display for outgoing calls via the Basic MULAP trunk.

Up to 20 members can be configured per Basic MULAP.

Every Basic MULAP can be assigned a name containing up to 16 characters.

Each of the subscriber's phones is a member of the Basic MULAP and each member can be assigned the following properties:

- **Master**

This parameter changes a member into a master of the Basic MULAP. If a master activates call forwarding, this feature applies to all members (phones) in the Basic MULAP. If the master activates an automatic callback on a Basic MULAP, the callback is initiated as soon as all masters are free.

A subscriber may not be included as a MULAP master in hunt groups more than 25 times.

Default setting: master is the first member of the Basic MULAP.

- **Acoustic ring**

If this parameter is activated, incoming calls are signaled acoustically.

Default setting: the parameter is active for all masters.

- **Automatic seizure outgoing**

If this parameter is active, the Basic MULAP trunk is automatically called when the subscriber lifts the handset. If the parameter is not active, the subscriber must press the MULAP key before dialing is possible.

Default setting: automatic outgoing seizure is assigned to all masters.

- **No automatic incoming call acceptance**

If this parameter is activated, you cannot answer an incoming call by lifting the handset. An incoming call must be accepted by pressing the MULAP key.

Default setting: the parameter is not activated.

- **Automatic conference release**

If the parameter is active, you can release the seized MULAP line for a conference by pressing the MULAP key. The release of this line is signaled to

all other members by the flashing MULAP key. They can join the conference by pressing the MULAP key.

Default setting: the parameter is not activated.

- **MULAP key set up**

If the parameter is active, a MULAP key is programmed on the associated phone. You can press the key to set up an outgoing call via the Basic MULAP trunk. The Basic MULAP number appears on the called party's display.

Default setting: the parameter is activated.

### **Number/Name Display**

When an outgoing call is set up, a station number is assigned (local station number or MULAP group number).

When an incoming MULAP call is answered, the MULAP group number is assigned.

In the case of calls to a MULAP:

- Before the call is answered, the display of the calling party shows the MULAP name and/or MULAP number being called.
- After the call is answered, the display of the calling party shows the station name and/or MULAP number of the answering party.
- In the case of calls from a MULAP station (MULAP key or preference), the display of the called and answering parties always shows the station name and/or MULAP number..
- The following generally applies to outgoing seizures: If a station conducts a call using the local station number and the outgoing preference differs from the local station number, the display of the called party always shows the station number of the outgoing preference.

### **Using MULAP Keys**

The LED on a MULAP key can have different statuses with the following meaning:

- Off: the relevant trunk is free and can be used.
- Lit: the relevant trunk is busy.
- Flashing fast: call on the relevant trunk.
- Flashing slowly: an on-hold call is waiting on the relevant trunk or the relevant trunk was released for a conference.

### **Ring type**

For every Basic MULAP, an administrator with the **Expert** profile can define the acoustic signaling of incoming external calls via the ring type setting. You have the following options:

- Two rings (default setting)
- Three rings
- short-long-short ring

Only the default setting is possible for analog phones. Changes have no effect.

### SIP Phones

SIP telephones can be integrated in a Basic MULAP. As a prerequisite, a TDM, HFA or SIP phone must have been defined as the first member of the Basic MULAP.

Dual-mode mobile phones that are configured as Mobility Entry stations, for example, can be integrated. Dual-mode mobile phones support both GSM/UMTS networks and WLAN networks. A dual-mode mobile phone can be registered as an IP station (SIP client) at the communication system over a WLAN.

---

**INFO:** No programming of MULAP keys is possible for SIP phones. Furthermore, no features can be activated or deactivated via codes. Specific display messages of the Basic MULAP are not supported.

---

### Dependencies

Topic	Dependency
Do Not Disturb	When Do Not Disturb is activated, incoming calls are no longer put through.
ISDN Phones	It is not possible to include ISDN telephones in Basic MULAPs.

---

### Related Topics

- [How to Add a Basic MULAP](#)
- [How to Display or Edit a Basic MULAP](#)
- [How to Delete a Basic MULAP](#)
- [How to Add or Delete a Member to or from a Basic MULAP](#)
- [How to Edit a Member of a Basic MULAP](#)

## 14.3.2 Executive MULAP

You can configure Executive MULAPs if you want to use restricted executive and secretary functions.

All members of an Executive MULAP can be reached at the Executive MULAP phone number as well as at their personal station numbers.

---

**INFO:** The terms "executive" and "secretary" used in this document are gender-neutral.

---

Up to 20 members can be configured per Executive MULAP.

Every Executive MULAP can be assigned a name containing up to 16 characters.

The parameters described below define which members of an Executive MULAP can use executive functions (Executive) and which can use secretary functions (Secretary).

If a caller rings the Executive MULAP phone number, the call is visually signaled at all phones belonging to the Executive MULAP. Incoming calls are also signaled acoustically for members with secretary functions.

The Executive MULAP phone number is shown on the called party's display for outgoing calls via the Executive MULAP trunk.

The members of an Executive MULAP can be assigned the following properties:

- **Master**  
This parameter is used to assign executive functions to a member. The Executive MULAP trunk is automatically selected for a call when you lift the handset. Incoming calls via the Executive MULAP phone number are only signaled visually.  
A subscriber may not be included as a MULAP master in hunt groups more than 25 times.  
Default setting: the first member of the Executive MULAP is assigned executive functions.
- **Acoustic ring**  
If this parameter is activated, incoming calls are signaled acoustically.  
Default setting: the parameter is active for all members with the secretary function.
- **Automatic seizure outgoing**  
If this parameter is active, the Executive MULAP trunk is automatically called when you lift the handset. If the parameter is not active, the subscriber must press the MULAP key before dialing is possible.  
This parameter cannot be used by members with the secretary function.  
Default setting: the parameter is active for all members with the executive function.
- **No automatic incoming call acceptance**  
If this parameter is activated, you cannot answer an incoming call by lifting the handset. An incoming call must be accepted by pressing the MULAP key.  
Default setting: the parameter is not activated.
- **Automatic conference release**  
If the parameter is active, you can release the seized MULAP line for a conference by pressing the MULAP key. The release of this line is signaled to all other members by the flashing MULAP key. They can join the conference by pressing the MULAP key.  
Default setting: the parameter is not activated.
- **MULAP key set up**  
If the parameter is active, a MULAP key is programmed on the associated phone. You can press the key to set up an outgoing call via the Executive MULAP trunk. The Executive MULAP phone number appears on the called party's display.  
Default setting: the parameter is activated.

### Using MULAP Keys

The LED on a MULAP key can have different statuses with the following meaning:

- Off: the relevant trunk is free and can be used.
- Lit: the relevant trunk is busy.
- Flashing fast: call on the relevant trunk.
- Flashing slowly: an on-hold call is waiting on the relevant trunk or the relevant trunk was released for a conference.

### Ring type

For every Executive MULAP, an administrator with the **Expert** profile can define the acoustic signaling of incoming external calls via the ring type setting. You have the following options:

- Two rings (default setting)
- Three rings
- short-long-short ring

Only the default setting is possible for analog phones. Changes have no effect.

### SIP Phones

SIP telephones can be integrated in an Executive MULAP. As a prerequisite, a system telephone (IP, HFA or SIP phone, for example) must have been defined as the first member of the Executive MULAP (Exec. 1).

Dual-mode mobile phones that are configured as Mobility Entry stations, for example, can be integrated. Dual-mode mobile phones support both GSM/UMTS networks and WLAN networks. A dual-mode mobile phone can be registered as an IP station (SIP client) at the communication system over a WLAN.

---

**INFO:** No programming of MULAP keys is possible for SIP phones. Furthermore, no features can be activated or deactivated via codes. Specific display messages of the Executive MULAP are not supported.

---

### Dependencies

Topic	Dependency
Do Not Disturb	When Do Not Disturb is activated, incoming calls are no longer put through.
ISDN Phones	It is not possible to include ISDN telephones in Executive MULAPs.

---

### Related Topics

- [How to Add an Executive MULAP](#)
- [How to Display or Edit an Executive MULAP](#)

- [How to Delete an Executive MULAP](#)
- [How to Add or Delete a Member to or from an Executive MULAP](#)
- [How to Edit a Member of an Executive MULAP](#)

### 14.3.3 Configuring Basic MULAPs and Executive MULAPs

The configuration of Basic and Executive MULAPs can only be performed by an administrator with the **Expert** profile and in **Expert mode**.

The procedure for the following application cases, which can be configured using the **Expert mode** wizard, is described here:

- [How to Add a Basic MULAP](#)
- [How to Display or Edit a Basic MULAP](#)
- [How to Delete a Basic MULAP](#)
- [How to Add or Delete a Member to or from a Basic MULAP](#)
- [How to Edit a Member of a Basic MULAP](#)
- [How to Add an Executive MULAP](#)
- [How to Display or Edit an Executive MULAP](#)
- [How to Delete an Executive MULAP](#)
- [How to Add or Delete a Member to or from an Executive MULAP](#)
- [How to Edit a Member of an Executive MULAP](#)

#### 14.3.3.1 How to Add a Basic MULAP

##### *Prerequisites*

- You are logged into the WBM with the **Expert** profile.

##### *Step by Step*

- 1) In the navigation bar, click on **Expert Mode**.
- 2) In the navigation tree, click **Telephony > Incoming Calls**.
- 3) Click **Incoming Calls > Groups/Hunt groups** in the menu tree.
- 4) Click on the **Add Group** tab.
- 5) Enter the call number of the new Basic MULAP in the **Phone Number** field.
- 6) Enter the DID number of the new Basic MULAP in the **Direct inward dialing number** field.
- 7) Enter the name of the new Basic MULAP in the **Name** field.
- 8) Select **Basic MULAP** in the **Type** drop-down list.
- 9) Select the call number for the subscriber that you want to assign to the Basic MULAP group from the **Phone Number** drop-down list.

- 10) Click on **Apply** followed by **OK**.

---

**INFO:** In applications using CSTA interface (UC, OSCC, etc.) when a Basic MULAP group or a member of a Basic MULAP group is created, a system restart is needed.

---

---

**Related Topics**

- [Basic MULAP](#)

### 14.3.3.2 How to Display or Edit a Basic MULAP

**Prerequisites**

- You are logged into the WBM with the **Expert** profile.

**Step by Step**

- 1) In the navigation bar, click on **Expert Mode**.
- 2) In the navigation tree, click **Telephony > Incoming Calls**.
- 3) Navigate in the menu tree under **Incoming Calls > Groups/Hunt groups > ...** down to the desired Basic MULAP.
- 4) Click on the **Edit Group Parameters** tab. The current settings of the group parameters are displayed.
- 5) Edit the desired parameters for the Basic MULAP if required.
- 6) Click on **Apply** followed by **OK**.

---

**Related Topics**

- [Basic MULAP](#)

### 14.3.3.3 How to Delete a Basic MULAP

**Prerequisites**

- You are logged into the WBM with the **Expert** profile.

**Step by Step**

- 1) In the navigation bar, click on **Expert Mode**.
- 2) In the navigation tree, click **Telephony > Incoming Calls**.
- 3) Navigate in the menu tree under **Incoming Calls > Groups/Hunt groups > ...** down to the desired Basic MULAP.



- 4) Click on the **Delete Group** tab.
- 5) Click on **Delete** followed by **OK**.

---

**INFO:** In applications using CSTA interface (UC, OSCC, etc.) when a Basic MULAP group or a member of a Basic MULAP group is deleted, a system restart is needed.

---

---

**Related Topics**

- [Basic MULAP](#)

### 14.3.3.4 How to Add or Delete a Member to or from a Basic MULAP

**Prerequisites**

- You are logged into the WBM with the **Expert** profile.

**Step by Step**

- 1) In the navigation bar, click on **Expert Mode**.
- 2) In the navigation tree, click **Telephony > Incoming Calls**.
- 3) Select one of the following options:
  - To add a member to a Basic MULAP, navigate in the menu tree under **Incoming Calls > Groups/Hunt groups > ...** down to the desired Basic MULAP. Click on the **Add Member** tab. Select the call number of the desired station in the **Phone Number** drop-down list. Then click **Apply**, followed by **OK**.
  - To remove a member from a Basic MULAP, navigate in the menu tree under **Incoming Calls > Groups/Hunt groups > ...** down to the desired member of the Basic MULAP ((Group Member) Call No, Name). Click on the **Delete Member** tab. Click on **Delete** followed by **OK**.

---

**Related Topics**

- [Basic MULAP](#)

### 14.3.3.5 How to Edit a Member of a Basic MULAP

**Prerequisites**

- You are logged into the WBM with the **Expert** profile.

### ***Step by Step***

- 1) In the navigation bar, click on **Expert Mode**.
- 2) In the navigation tree, click **Telephony > Incoming Calls**.
- 3) Navigate in the menu tree under **Incoming Calls > Groups/Hunt groups > ...** down to the desired member of the Basic MULAP ((Group member) Station Number, Name).
- 4) Click on the **Edit Member** tab.
- 5) Change the required parameters.
- 6) Click on **Apply** followed by **OK**.

---

#### **Related Topics**

- [Basic MULAP](#)

## **14.3.3.6 How to Add an Executive MULAP**

### ***Prerequisites***

- You are logged into the WBM with the **Expert** profile.

### ***Step by Step***

- 1) In the navigation bar, click on **Expert Mode**.
- 2) In the navigation tree, click **Telephony > Incoming Calls**.
- 3) Click **Incoming Calls > Groups/Hunt groups** in the menu tree.
- 4) Click on the **Add Group** tab.
- 5) Enter the call number of the new Executive MULAP in the **Phone Number** field.
- 6) Enter the DID number of the new Executive MULAP in the **Direct inward dialing number** field.
- 7) Enter the name of the new Executive MULAP in the **Name** field.
- 8) Select **Executive MULAP** in the **Type** drop-down list.
- 9) Select the call number for the subscriber that you want to assign to the Executive MULAP group from the **Phone Number** drop-down list.
- 10) Click on **Apply** followed by **OK**.

---

#### **Related Topics**

- [Executive MULAP](#)

### 14.3.3.7 How to Display or Edit an Executive MULAP

#### *Prerequisites*

- You are logged into the WBM with the **Expert** profile.

#### *Step by Step*

- 1) In the navigation bar, click on **Expert Mode**.
- 2) In the navigation tree, click **Telephony > Incoming Calls**.
- 3) Navigate in the menu tree under **Incoming Calls > Groups/Hunt groups > ...** down to the desired Executive MULAP.
- 4) Click on the **Edit Group Parameters** tab. The current settings of the group parameters are displayed.
- 5) Edit the desired parameters for the Executive MULAP if required.
- 6) Click on **Apply** followed by **OK**.

---

#### **Related Topics**

- [Executive MULAP](#)

### 14.3.3.8 How to Delete an Executive MULAP

#### *Prerequisites*

- You are logged into the WBM with the **Expert** profile.

#### *Step by Step*

- 1) In the navigation bar, click on **Expert Mode**.
- 2) In the navigation tree, click **Telephony > Incoming Calls**.
- 3) Navigate in the menu tree under **Incoming Calls > Groups/Hunt groups > ...** down to the desired Executive MULAP.
- 4) Click on the **Delete Group** tab.
- 5) Click on **Delete** followed by **OK**.

---

**INFO:** In applications using CSTA interface (UC, OSCC, etc.) when an Executive MULAP group or a member of an Executive MULAP group is deleted, a system restart is needed.

---

---

#### **Related Topics**

- [Executive MULAP](#)

### 14.3.3.9 How to Add or Delete a Member to or from an Executive MULAP

#### *Prerequisites*

- You are logged into the WBM with the **Expert** profile.

#### *Step by Step*

- 1) In the navigation bar, click on **Expert Mode**.
- 2) In the navigation tree, click **Telephony > Incoming Calls**.
- 3) Select one of the following options:
  - To add a member to an Executive MULAP, navigate in the menu tree under **Incoming Calls > Groups/Hunt groups > ...** down to the desired Executive MULAP. Click on the **Add Member** tab. Select the call number of the desired station in the **Phone Number** drop-down list. Then click **Apply**, followed by **OK**.
  - To remove a member from an Executive MULAP, navigate in the menu tree under **Incoming Calls > Groups/Hunt groups > ...** down to the desired member of the Executive MULAP ((Group Member) Call No, Name). Click on the **Delete Member** tab. Click on **Delete** followed by **OK**.

---

#### **Related Topics**

- [Executive MULAP](#)

### 14.3.3.10 How to Edit a Member of an Executive MULAP

#### *Prerequisites*

- You are logged into the WBM with the **Expert** profile.

#### *Step by Step*

- 1) In the navigation bar, click on **Expert Mode**.
- 2) In the navigation tree, click **Telephony > Incoming Calls**.
- 3) Navigate in the menu tree under **Incoming Calls > Groups/Hunt groups > ...** down to the desired member of the Basic MULAP ((Group member) Station Number, Name).
- 4) Click on the **Edit Member** tab.
- 5) Change the required parameters.
- 6) Click on **Apply** followed by **OK**.

---

#### **Related Topics**

- [Executive MULAP](#)

## 14.4 Voicemail Group and Fax Box Group

A voicemail group enables a subscriber group to access voicemails. When a call is placed to the call number of a voicemail group, the call is sent directly to the voicemail box (i.e., the voicemail) of the group and not to the group members. A fax box group (fax group) enables a subscriber group to access fax messages. The fax box of the group is reached directly via the station number of the fax box group.

### 14.4.1 Voicemail Group

A voicemail group enables a specific group of subscribers to access voicemails. When a call is placed to the call number of a voicemail group, the call is sent directly to the voicemail box (i.e., the voicemail) of the group and not to the group members. After a voicemail is left in the voicemail box of the group, it is forwarded to the voicemail boxes of all members.

All members receive the voicemail simultaneously. Whenever a member deletes a voicemail, this voicemail is also deleted from the voicemail boxes of all members and the voicemail box of the group. The personal voicemails of all members are not affected by this.

Every member of a voicemail group can be reached under his or her own station number.

Up to 20 members can be configured per voicemail group.

Every voicemail group can be assigned a name containing up to 16 characters.

At least one member of a voicemail group requires a Voicemail license.

#### Dependencies

Topic	Dependency
Ringling group on	The <i>Ringling group</i> feature cannot be used.

---

#### Related Topics

- [How to Add a Voicemail Group](#)
- [How to Display or Edit a Voicemail Group](#)
- [How to Delete a Voicemail Group](#)
- [How to Add or Delete a Member to a Voicemail Group](#)
- [How to Edit a Member of a Voicemail Group](#)

## 14.4.2 Fax Box Group

A fax box group (fax group) enables a specific group of subscribers to access fax messages. The fax box of the group is reached directly via the station number of the fax box group. After a fax message is left in the fax box of the group, it is forwarded to the fax boxes of all members.

All members receive the fax message simultaneously. Whenever a member deletes a fax message, this voicemail is also deleted from the fax boxes of all members and the fax box of the group.

Every member of a fax box group can be reached under his or her own station number.

Up to 20 fax box groups can be configured.

Every fax box group can be assigned a name containing up to 16 characters.

At least one member of a fax box group requires a Fax license.

## 14.4.3 Configuring Voicemail Box Groups and Fax Box Groups

The configuration of voicemail box groups and fax box groups can only be performed by an administrator with the **Expert** profile and in **Expert mode**.

The procedure for the following application cases, which can be configured using the **Expert mode** wizard, is described here:

- [How to Add a Voicemail Group](#)
- [How to Display or Edit a Voicemail Group](#)
- [How to Delete a Voicemail Group](#)
- [How to Add or Delete a Member to a Voicemail Group](#)
- [How to Edit a Member of a Voicemail Group](#)
- [How to Configure a Fax Box Group](#)
- [How to Display or Edit a Fax Box Group](#)
- [How to Delete a Fax Box Group](#)
- [How to Add or Delete a Member to a Fax Box Group](#)

### 14.4.3.1 How to Add a Voicemail Group

#### *Prerequisites*

- You are logged into the WBM with the **Expert** profile.

#### *Step by Step*

- 1) In the navigation bar, click on **Expert Mode**.
- 2) In the navigation tree, click **Telephony > Incoming Calls**.

- 3) Click **Incoming Calls > Groups/Hunt groups** in the menu tree.
- 4) Click on the **Add Group** tab.
- 5) Enter the call number of the new voicemail group in the **Phone Number** field.
- 6) Enter the DID number of the new voicemail group in the **Direct inward dialing number** field.
- 7) Enter the name of the new voicemail group in the **Name** field.
- 8) Select the item **Voicemail** in the **Type** drop-down list.
- 9) Select the call number for the subscriber that you want to assign to the new voicemail group from the **Phone Number** drop-down list.
- 10) Click on **Apply** followed by **OK**.

---

**Related Topics**

- [Voicemail Group](#)

### 14.4.3.2 How to Display or Edit a Voicemail Group

**Prerequisites**

- You are logged into the WBM with the **Expert** profile.

**Step by Step**

- 1) In the navigation bar, click on **Expert Mode**.
- 2) In the navigation tree, click **Telephony > Incoming Calls**.
- 3) Navigate in the menu tree under **Incoming Calls > Groups/Hunt groups > ...** down to the desired voicemail group.
- 4) Click on the **Edit Group Parameters** tab. The current settings of the group parameters are displayed.
- 5) Edit the desired parameters for the voicemail group if required.
- 6) Click on **Apply** followed by **OK**.

---

**Related Topics**

- [Voicemail Group](#)

### 14.4.3.3 How to Delete a Voicemail Group

**Prerequisites**

- You are logged into the WBM with the **Expert** profile.

### ***Step by Step***

- 1) In the navigation bar, click on **Expert Mode**.
- 2) In the navigation tree, click **Telephony > Incoming Calls**.
- 3) Navigate in the menu tree under **Incoming Calls > Groups/Hunt groups > ...** down to the desired voicemail group.
- 4) Click on the **Delete Group** tab.
- 5) Click on **Delete** followed by **OK**.

---

#### **Related Topics**

- [Voicemail Group](#)

## **14.4.3.4 How to Add or Delete a Member to a Voicemail Group**

### ***Prerequisites***

- You are logged into the WBM with the **Expert** profile.

### ***Step by Step***

- 1) In the navigation bar, click on **Expert Mode**.
- 2) In the navigation tree, click **Telephony > Incoming Calls**.
- 3) Select one of the following options:
  - To add a member to a voicemail group, navigate in the menu tree under **Incoming Calls > Groups/Hunt groups > ...** down to the desired voicemail group. Click on the **Add Member** tab. Select the call number of the desired station in the **Phone Number** drop-down list. Then click **Apply**, followed by **OK**.
  - To remove a member from a voicemail group, navigate in the menu tree under **Incoming Calls > Groups/Hunt groups > ...** down to the desired member of the voicemail group ((Group Member) Call No, Name). Click on the **Delete Member** tab. Click on **Delete** followed by **OK**.

---

#### **Related Topics**

- [Voicemail Group](#)

## **14.4.3.5 How to Edit a Member of a Voicemail Group**

### ***Prerequisites***

- You are logged into the WBM with the **Expert** profile.



### Step by Step

- 1) In the navigation bar, click on **Expert Mode**.
- 2) In the navigation tree, click **Telephony > Incoming Calls**.
- 3) Navigate in the menu tree under **Incoming Calls > Groups/Hunt groups > ...** down to the desired member of the Voicemail group ((Group member) Station Number, Name).
- 4) Click on the **Edit Member** tab.
- 5) Change the required parameters.
- 6) Click on **Apply** followed by **OK**.

---

#### Related Topics

- [Voicemail Group](#)

## 14.4.3.6 How to Configure a Fax Box Group

### Prerequisites

- You are logged into the WBM with the **Expert** profile.

### Step by Step

- 1) In the navigation bar, click on **Expert Mode**.
- 2) In the navigation tree, click on **Telephony > Station**.
- 3) In the menu tree, click **Stations > UC Applications > Fax Group**. The already configured fax box groups are displayed.
- 4) Select the next free row and enter the call number of the new fax box group in the **Phone Number** field.
- 5) Enter the DID number of the new fax box group in the **DID** field.
- 6) Enter the name of the new fax box group in the **Name** field.
- 7) Select the item **Fax Group** in the **Type** drop-down list.
- 8) Click **Apply** followed by **OK**.
- 9) Close the **Fax Group** window.
- 10) In the navigation tree, click on **Applications > OpenScape Business UC Suite**.
- 11) Click **Groups**.
- 12) Click on the **Fax Groups** tab.
- 13) Select the new fax box group and click **Edit**.
- 14) Select one of the following options:

## Working in a Team (Groups)

### Voicemail Group and Fax Box Group

- If you want to add a member to a fax box group, mark the desired member in the **Users** list.
- If you want to add several members to the fax box group, press the <Ctrl> key and select the desired members in the **Users** list.

15) Click **Save**.

### 14.4.3.7 How to Display or Edit a Fax Box Group

#### *Prerequisites*

- You are logged into the WBM with the **Expert** profile.

#### *Step by Step*

- 1) In the navigation bar, click on **Expert Mode**.
- 2) In the navigation tree, click on **Telephony > Station**.
- 3) In the menu tree, click **Stations > UC Applications > Fax Group**.
- 4) Click on the desired fax box group in the menu tree.
- 5) Click the **Edit Station Parameters** tab.
- 6) Edit the desired parameters for the fax box group if required.
- 7) Click **Apply** followed by **OK**.

### 14.4.3.8 How to Delete a Fax Box Group

#### *Prerequisites*

- You are logged into the WBM with the **Expert** profile.

#### *Step by Step*

- 1) In the navigation bar, click on **Expert Mode**.
- 2) In the navigation tree, click on **Applications > OpenScape Business UC Suite**.
- 3) Click on **Groups**.
- 4) Click on the **Fax Groups** tab.
- 5) Mark the desired fax box group and click **Remove**.

### 14.4.3.9 How to Add or Delete a Member to a Fax Box Group

#### *Prerequisites*

- You are logged into the WBM with the **Expert** profile.

### Step by Step

- 1) In the navigation bar, click on **Expert Mode**.
- 2) In the navigation tree, click on **Applications > OpenScape Business UC Suite**.
- 3) Click on **Groups**.
- 4) Click on the **Fax Groups** tab.
- 5) Mark the desired fax box group and click **Edit**. The **Users** list is displayed with the existing members marked in it.
- 6) Select one of the following options:
  - If you want to add a member to the fax box group, press the <Ctrl> key and select the new member in addition to the already existing members in the **Users** list.
  - If you want to remove a member from the fax box group, press the <Ctrl> key and deselect the desired member in the **Users** list.
- 7) Click on **Save**.

## 14.5 Speaker Call for Groups

Speaker call for groups enable the broadcasting of announcements to all internal members of a group.

### 14.5.1 Internal Paging

Internal paging enables internal members of a group to be addressed directly. This feature is also known as a group broadcast. Internal paging is not performed for group members who are busy or have activated the Do Not Disturb feature. Group members have no direct answering option. Answering is only possible by lifting the handset, which results in a transition to a normal two-way conversation.

Internal paging can be used via a function key programmed for this purpose, the menu item **Speaker call** or by entering the appropriate code and then dialing the station number of the target group. A function key can also be programmed with a group phone number. A connection to the programmed group is immediately set up when you press a function key of this kind.

### Dependencies

Topic	Dependency
Do Not Disturb	Group members who have activated DND do not receive any announcements.
ISDN phones, SIP phones	The "Internal Paging" feature cannot be used with ISDN or SIP phones.

## 14.5.2 Transfer to Group from Announcement

A call on consultation hold can be transferred to a group via Transfer from Announcement. An announcement to the group is initiated for this (internal paging). The system sets up a two-party call when another party in the group lifts the handset or turns on the loudspeaker and the party who transferred the call hangs up. The connection is cleared down for the other group members.

Internal paging can be used via a function key programmed for this purpose, the menu item **Speaker call** or by entering the appropriate code and then dialing the station number of the target group. A function key can also be programmed with a group phone number. A connection to the programmed group is immediately set up when you press a function key of this kind.

### Dependencies

Topic	Dependency
Do Not Disturb	Group members who have activated DND do not receive any announcements.
ISDN phones, SIP phones	The "Transfer to Group from Announcement" feature cannot be used with ISDN and SIP phones.

## 14.6 UCD (Uniform Call Distribution)

The Uniform Call Distribution (UCD) feature of the communication system enables incoming calls to be uniformly distributed to a group of stations (UCD-group).

UCD groups are primarily used in technical hotline environments (e.g., customer service hotlines), for managing complaints, in market research, order processing and acceptance (e.g., by mail-order companies and ticketing services) and even for emergency services.

As a rule, call distribution occurs by sending an incoming call to a UCD group to the station (agent) in the UCD group whose last call lies furthest in the past. It is also possible to define other distribution rules.

If there is no agent free to accept an incoming call, the call is automatically forwarded to a queue. Waiting calls are distributed to free agents on the basis of priority and wait time.

Announcements or music on hold can be played for waiting callers.

### **Configuration**

The **UCD** wizard can be used to configure groups and stations for intelligent call distribution (UCD). The following application cases, which can be configured using the wizard, are described here:

- [How to Configure Call Distribution / UCD Groups](#)
- [How to Add or Delete UCD Agents](#)
- [How to Change Announcements / Music on Hold for UCD](#)

Besides the configuration options available through wizards, administrators with the **Expert** profile are also offered additional configuration options in **Expert mode**.

## **14.6.1 Call Distribution / UCD Group**

A UCD group contains agents (subscribers) that belong to a work group and can be reached at a single phone number. An incoming internal or external call is automatically delivered to the agent who is idle longest.

Every UCD group can be configured using the WBM (**in Expert mode**) so that incoming calls to an agent are automatically accepted by the communication system (Unattended Incoming Call Connection AICC).

If all agents of a UCD group are busy, incoming calls can be placed in a queue. The maximum number of calls in the queue can be individually set for every UCD group. When the maximum number of queued calls is reached, further calls can be forwarded to an overflow destination (which may be an external destination, another UCD group, an internal station or a group).

If the overflow destination is another UCD group and if all other agents in this UCD group are busy, the call remains in the queue associated with the original group and is also entered in the queue of the other UCD group (overflow destination).

Announcements or music can be played for on-hold callers.

Every UCD group can be assigned a name containing up to 16 characters.

## Dependencies

Topic	Dependency
Call forwarding	<p>A call is not forwarded to a UCD group in the following cases:</p> <ul style="list-style-type: none"><li>• If a hunt group is called and a subscriber with call forwarding to a UCD group is next, this call is not forwarded. In this case, the next station in the hunt group is immediately called.</li><li>• A subscriber is a member of a group call with the property "Group" and has activated call forwarding to a UCD group.</li><li>• A station is a member of a group call no answer. If the group is called, the call is not forwarded to the UCD group. Exception: The first subscriber entered has activated call forwarding to a UCD group. In this case, the call is forwarded.</li></ul>

### 14.6.1.1 How to Configure Call Distribution / UCD Groups

You can use the **UCD** wizard to configure intelligent call distribution to a group with selected stations.

#### *Prerequisites*

- You are logged on to the WBM with the **Advanced** profile.

#### *Step by Step*

- 1) In the navigation bar, click on **Setup**.
- 2) In the navigation tree, click **Wizards > User Telephony**.
- 3) Click on **Edit** to start the **UCD** wizard. The list of all possible UCD groups is displayed.
- 4) To configure a UCD group, click **Edit** in the row containing the required UCD group.
- 5) Enter the call number of the new UCD group in the **Call number** field.
- 6) Enter the DID number of the new UCD group in the **Direct inward dialing number** field.
- 7) Enter the name of the UCD group in the **Name** field.
- 8) Click on **OK & Next**. The window **Assignment of UCD Agents** is displayed.
- 9) Mark the required UCD agent IDs in the **Selection** and assign them to this UCD group by clicking **Add**.
- 10) Click on **OK & Next**. The **Edit announcement/overflow** window appears.

- 11)** Select the announcement of the UCD group in **Announcement** drop-down list. You can optionally select an announcement (if configured) or the internal Music On Hold (MOH). After you select the announcement, the **Ann. delay time** field appears.
- 12)** In the field **Ann. delay time**, enter the time (in seconds) after which a caller in the queue is to receive an announcement.
- 13)** Select the time after which a call is to be forwarded to the next UCD agent of the UCD group in the **Waiting time between agents** drop-down list.
- 14)** Select the overflow destination for the UCD group in the **Overflow destination** drop-down list. You can select an external destination, another UCD group, an internal station or a group.  
  
If you select **External destination** as the overflow destination, the **External destination** field and the **Route** drop-down list appears.
  - a)** Enter the call number of the external overflow destination in the **External destination** field.
  - b)** If the external overflow destination is to be reached via a specific route, select the route in the **Route** drop-down list.
- 15)** Click on **OK** to accept the entries.
- 16)** If you want to configure further UCD groups, repeat steps 4 through 15.
- 17)** Click on **OK & Next** followed by **Finish**.

## 14.6.2 UCD Agents

The stations of a UCD group (agents) comprise a workgroup and are typically deployed for technical hotlines, for example, or in order processing, order acceptance, CRM, etc. All incoming calls are distributed to the available stations in a UCD group.

The assignment of agents to the UCD groups occurs via identification codes (IDS). An ID can be assigned to no more than one UCD group. An agent can be assigned multiple IDs. This lets an agent work in more than once UCD group. An agent, however, can only be logged on and therefore active in one UCD group at a time.

In order to use the UCD functions effectively, agents should have phones equipped with a display, function keys and a headset.

### Logging on/off

Agents can log into any phone of the communication system (except ISDN and SIP phones) by using their respective IDs (Identification Code). The agent is available following successful login and permanently assigned to the relevant phone until he or she logs off. The agent cannot log into another phone. Agents who have logged off are no longer considered for the call distribution.

The UCD functions for logging in, logging out and for changing the station status can be accessed by agents from the telephone via programmed function keys or via the associated menu items or via codes.

### Subscriber states

An agent's state is **available** following successful login. If required, a agent can set his or her own station status, or the status may be changed automatically, depending on the agent's current activity. The current subscriber state is shown on the phone's display.

The following displays are possible:

Display	Meaning
available	The agent is available and can accept UCD calls.
not available	The agent temporarily logged off his or her workstation (for example, for a break).
wrap up	The agent is in wrap-up mode. He or she does not receive any UCD calls during the wrap-up time. Depending on the configuration, this can be an individual wrap-up time (the agent independently defines the length of the wrap-up time by changing his or her subscriber status) or an automatic wrap-up time (a wrap-up time is automatically available to all agents after a UCD call).
for <UCD group name>	The agent receives a UCD call.

An agent logs off after his or her shift and is therefore no longer available for UCD calls. The agent can still be reached at his or her personal station number.

If all agents of a UCD group are in the state **not available**, incoming calls are forwarded to an overflow destination (an external destination, another UCD group, an internal station or a group).

If an agent does not accept a call although he or she is logged on and available, the communication system automatically sets the status of that station to **not available**.

### Dependencies

Topic	Dependency
Call forwarding	If an agent activates the Call Forwarding feature, he or she is automatically logged off and is no longer available for UCD calls.
ISDN phones, SIP phones	It is not possible to use ISDN and SIP phones here.

## 14.6.2.1 How to Add or Delete UCD Agents

The **UCD** wizard can be used to add UCD agents to a UCD group or to delete them from a UCD group.



### **Prerequisites**

- You are logged on to the WBM with the **Advanced** profile.

### **Step by Step**

- 1) In the navigation bar, click on **Setup**.
- 2) In the navigation tree, click **Wizards > User Telephony**.
- 3) Click on **Edit** to start the **UCD** wizard. The list of all possible UCD groups is displayed.
- 4) To add UCD agents to a UCD group or delete them, click **Edit** in the row containing the required UCD group.
- 5) Click on **OK & Next** to go to the **Assignment of UCD agents** window.
- 6) Select one of the following options:
  - If you want to add a UCD agent, mark the required UCD agent IDs in the **Selection** and assign them to this UCD group by clicking **Add**.
  - If you want to delete UCD agents, mark the desired **Members** and delete them from the UCD group by clicking **Delete**.
- 7) Click on **OK & Next** to confirm the entries.
- 8) Click on **OK**.
- 9) If you want to edit the UCD agents of another UCD group, repeat steps 4 through 8.
- 10) Click on **OK & Next** followed by **Finish**.

## **14.6.3 Wrap up**

This feature temporarily removes an agent from the call distribution in order to allow the agent some time to wrap up the call just completed. The agent does not receive any UCD calls during the wrap-up time.

A distinction is made between:

- the individual wrap-up time.  
The agent sets the wrap-up time length by changing his or her subscriber state.
- the automatic wrap-up time.  
The Uniform Call Distribution (UCD) feature is configured for this in such a way that a wrap-up time is automatically made available to all agents in all UCD groups after a UCD call. The automatic wrap-up time is defined in ring cycles, that is, in increments of five seconds.  
An agent can manually extend the automatic wrap-up time by changing his or her subscriber state.

An agent can be reached throughout the wrap-up time via his or her personal station number.

### 14.6.3.1 How to Change the Automatic Wrap-Up Time

#### *Prerequisites*

- You are logged into the WBM with the **Expert** profile.

#### *Step by Step*

- 1) In the navigation bar, click on **Expert Mode**.
- 2) In the navigation tree, click **Telephony > Incoming Calls**.
- 3) Click on **Incoming Calls > UCD** in the menu tree.
- 4) Click on the **Edit UCD Parameters** tab.
- 5) Select the wrap-up time that should be available to all UCD agents in the **Wrapup Mode (Cycles)** drop-down list. This is defined in ring cycles, that is, in increments of five seconds.
- 6) Click on **Apply** followed by **OK**.

### 14.6.4 Call Prioritization

You can set a priority for incoming internal and external calls for a UCD group. The queued calls are distributed to the agents in a UCD group on the basis of priority and the wait time.

A queued call with a high priority is answered before a call that has been waiting longer but has a lower priority. A queued call with low priority will be forwarded to an overflow destination before a queued call with high priority.

Priorities are assigned on the basis of trunks for external calls (per B channel), regardless of whether IP or TDM lines are involved.

Examples:

- Communication system with ISDN Primary Rate Interface ( $S_{2M}$  interface) and ISDN Point-to-Multipoint connection ( $S_0$  interface)  
Incoming calls via the ISDN Primary Rate Interface are normal customer calls. All B channels of the  $_{2M}$  interface are thus assigned a medium priority. Calls received via the ISDN point-to-multipoint connection are urgent calls, e.g., high-priority orders for spare parts. All B channels of the  $S_0$  interface are thus assigned a high priority.
- Communication system with a point-to-point connection to an Internet Telephony Service Provider ITSP and an ISDN point-to-multipoint connection ( $S_0$  interface)  
Incoming calls via the PABX number for IP telephony are normal customer calls. All B channels of the LAN interface are thus assigned a medium priority. Calls received via the ISDN point-to-multipoint connection are urgent calls, e.g., high-priority orders for spare parts. All B channels of the  $S_0$  interface are thus assigned a high priority.

The priority is set system-wide for internal calls and therefore applies equally to all internal calls.

Ten priority levels (1 = high, 10 = low) are available.

By default, priority = 10 is set for internal calls, and priority = 1 for external calls.

### 14.6.4.1 How to Change Request Priorities

#### *Prerequisites*

- You are logged into the WBM with the **Expert** profile.

#### *Step by Step*

- 1) In the navigation bar, click on **Expert Mode**.
- 2) In the navigation tree, click **Telephony > Incoming Calls**.
- 3) Click on **Incoming Calls > UCD** in the menu tree.
- 4) Click on the **Edit UCD Parameters** tab.
- 5) In the **Priorities, internal** drop-down list, select the priority that should apply to all internal calls for all UCD groups (1 = highest priority, 10 = lowest priority).
- 6) For each trunk (B channel), select the priority, in the associated **Priority** drop-down list, that is to apply to external calls over this trunk to all UCD groups (1 = highest priority, 10 = lowest priority). For every B channel, an individual priority can be set.
- 7) Click on **Apply** followed by **OK**.

### 14.6.5 Accepting UCD Calls Automatically

This feature lets agents accept incoming calls without any additional operations (Automatic Incoming Call Connection AICC).

This feature can only be used if the agent's phone has a headset and Disconnect key. An audible tone notifies the agent via the headset about an incoming call that is then automatically put through.

An agent can clear down an ongoing call by pressing the Disconnect key.

The "AICC" feature is not activated by default. Activation is performed on a group-specific basis and applies to all agents in a UCD group, irrespective of whether or not the agent's phone features a headset.

#### 14.6.5.1 How to Change the Automatic Acceptance of UCD Calls

#### *Prerequisites*

- You are logged into the WBM with the **Expert** profile.

### **Step by Step**

- 1) In the navigation bar, click on **Expert Mode**.
- 2) In the navigation tree, click **Telephony > Incoming Calls**.
- 3) Navigate in the menu tree under **Incoming Calls > UCD > ...** down to the desired UCD group.
- 4) Click on the **Edit UCD Groups** tab.
- 5) Select one of the following options:
  - If you want the UCD agents of this UCD group to be able to accept incoming calls without additional operating steps, select **yes** in the **AICC** drop-down list.
  - If you do not want the UCD agents of this UCD group to be able to accept incoming calls without the usual operating steps (such as picking up the handset, for example), then select **no** in the **AICC** drop-down list
- 6) Click on **Apply** followed by **OK**.

## **14.6.6 UCD queue**

If all agents of a UCD group are busy, incoming calls can be placed in a queue. Announcements or music can be played for on-hold callers.

If a call that is waiting in the queue for a specific period (first call cycle) is not accepted by the agent longest in **available** state, this agent's state is changed to **not available** and the call is transferred to the next available agent. If this agent does not answer the call either within a set period (second call cycle), the status of this agent is changed to **not available**. The call is routed to the overflow destination if the status of all agents is **not available**.

For every UCD group, the maximum number of calls in the queue can be set individually. If the maximum number of waiting calls is exceeded, further calls can be routed to an overflow destination.

You can select an external destination, another UCD group, an internal station or a group as the overflow destination. If the overflow destination is another UCD group and if all other agents in this UCD group are busy, the call remains in the queue associated with the original group and is also entered in the queue of the other UCD group (overflow destination).

An agent can query the number of calls in the queue for his or her UCD group with a specially programmed function key or via the assigned menu item or code.

### **Calls in a Queue**

The maximum number of calls in the queue is 30 for UCD groups 1 through 59 and 72 for UCD group 60.

The minimum number of calls in the queue is zero. There is no queue if the minimum number is set to zero. Calls are redirected or rejected directly at an overflow destination if there is no agent available.

### 14.6.6.1 How to Change the UCD Queue

#### *Prerequisites*

- You are logged into the WBM with the **Expert** profile.

#### *Step by Step*

- 1) In the navigation bar, click on **Expert Mode**.
- 2) In the navigation tree, click **Telephony > Incoming Calls**.
- 3) Navigate in the menu tree under **Incoming Calls > UCD > ...** down to the desired UCD group.
- 4) Click on the **Edit UCD Groups** tab.
- 5) Select the number of primary ring cycles in the **Prim. ring cycles** drop-down list. This is defined in ring cycles, that is, in increments of five seconds. This setting specifies how long a call remains in the queue if not accepted by the agent longest in "available" state. The call is then forwarded to the next available agent.
- 6) Select the number of secondary ring cycles in the **Sec. ring cycles** drop-down list. This is defined in ring cycles, that is, in increments of five seconds. This setting specifies how long a call remains in the queue if not accepted by the next available agent.
- 7) Select whether a change of announcement (Ann. change) should take place:
  - If the queued callers should hear the announcement only once, select the item **once** in the **Ann. change** drop-down list.
  - If the queued callers should hear cyclically varying announcements, select the item **cyclic** in the **Ann. change** drop-down list.
- 8) In the field **Ann. delay time**, enter the time after which a caller in the queue receives an announcement. The specification is made in seconds.
- 9) Click on **Apply** followed by **OK**.

### 14.6.7 UCD Overflow

UCD calls can be forwarded to an overflow destination if they are not accepted by the agents of a UCD group and if no queue was set up or if the maximum number of calls in the queue was reached.

---

**INFO:** The UCD overflow concept defines only one overflow destination, the second CDL entry. Therefore, the announcements are played only when the call is at the UCD overflow destination and not for the whole ringing cycle. When a call leaves the UCD overflow destination then default MOH is opened.

---

The maximum number of calls in the queue can be individually set for every UCD group. If this number is exceeded, further calls can be routed to an overflow destination.

If you do not want a queue to be created, you can enter zero as the maximum number of calls in the queue. Unanswered calls are then immediately routed to an overflow destination.

#### **Dependencies**

<b>Topic</b>	<b>Dependency</b>
AutoAttendant	It is not possible to use an AutoAttendant as an overflow destination.

### **14.6.7.1 How to Change the UCD Overflow**

#### *Prerequisites*

- You are logged into the WBM with the **Expert** profile.

#### *Step by Step*

- 1) In the navigation bar, click on **Expert Mode**.
- 2) In the navigation tree, click **Telephony > Incoming Calls**.
- 3) Navigate in the menu tree under **Incoming Calls > UCD > ...** down to the desired UCD group.
- 4) Click on the **Edit UCD Groups** tab.
- 5) Enter the maximum number of queued calls in the **Queued calls** field. Calls exceeding this number are redirected to an overflow destination.
- 6) Enter the desired time in the **Overflow time** field. The specification is made in seconds.

Note: this setting is relevant only when an external UCD application is connected. If a queued call is not accepted by the UCD application within the overflow time, the call is processed further by the communication system in accordance with the Call Management specifications.

- 7) Click on **Apply** followed by **OK**.

### **14.6.8 UCD Night Service**

An individual night service can be configured for every UCD group. Night service can also be activated and deactivated by every agent in a UCD group. Following activation, all calls for this UCD group are forwarded to the night destination.

The night service destination can be defined as an internal station, another group, an announcement/MoH, the voicemail box of the communication system or an external destination.

### Activating / Deactivating

Activation or deactivation of the UCD night service can be achieved via a programmed function key or via the associated menu items or via codes. The call number of the desired night service destination must be entered at activation.

For more information on the communication system's night service, see [Night Service](#).

### Dependencies

Topic	Dependency
Subscriber state	If you activate the UCD night answer feature, your current subscriber status does not change. A forced logout of the agents who are still logged in does not occur.
Communication system's night service	The communication system's UCD night answer and night service can be activated and deactivated independently of one another. Example: A UCD group was entered as the night service destination for the communication system. Calls that reach this UCD group via the communication system's night service remain in this UCD group, irrespective of a UCD night answer.
Existing calls	Existing calls are not affected by the activation of UCD night answer.

## 14.6.9 Announcements / Music on Hold for UCD

Music On Hold (MoH) or announcements can be played to callers who cannot be switched through directly to the agents of a UCD group. Music on hold and announcements can be assigned to each UCD group individually.

You have the following options:

- **Music On Hold (MOH)**  
Queued callers can be played music from the integrated source of the communication system. Further Music on Hold file(s) can be loaded from a PC into the communication system.  
For more information, see [Music on Hold](#)
- **Announcements**  
Queued callers can be played integrated announcements. Further announcements can be loaded from a PC into the communication system.  
For more information, see [Announcements](#)

The time up to the start of the announcement can be set (**Ann. delay time**). You can suppress the announcement by setting the maximum value (600 seconds). It is assumed here that the call will be accepted within this time.

### 14.6.9.1 How to Change Announcements / Music on Hold for UCD

You can use the **UCD** wizard to configure announcements and/or Music on Hold for UCD groups.

#### *Prerequisites*

- You are logged on to the WBM with the **Advanced** profile.

#### *Step by Step*

- 1) In the navigation bar, click on **Setup**.
- 2) In the navigation tree, click **Wizards > User Telephony**.
- 3) Click on **Edit** to start the **UCD** wizard. The list of all possible UCD groups is displayed.
- 4) To change the announcements / music on hold for a UCD group, click **Edit** in the row containing the required UCD group.
- 5) Click **OK & Next** until the **Edit announcement/overflow** window appears.
- 6) Select the announcement of the UCD group in **Announcement** drop-down list. You can optionally select an announcement (if configured) or the internal Music On Hold (MOH). After you select the announcement, the **Ann. delay time** field appears.
- 7) In the field **Ann. delay time**, enter the time (in seconds) after which a caller in the queue is to receive an announcement.
- 8) Click on **OK** to accept the entries.
- 9) If you want to add announcements / Music on Hold to another UCD group, repeat steps 4 through 8.
- 10) Click on **OK & Next** followed by **Finish**.

### 14.6.10 Transfer to UCD Groups

Internal and external calls can be transferred to UCD groups. If a call is not answered within a certain period, a recall is carried out.

The recall time is defined via the time parameter **Monitoring transfer to a UCD group prior to answer**. The default setting is 300 seconds. This setting can be changed by an administrator with the **Expert** profile in **Expert mode**.



## Dependencies

Topic	Dependency
Announcements	Announcements can be played for the external transferred calls. This is not possible for internal calls.
Recall time	The recall time for a transfer to UCD groups differs from the recall time for transfers to other subscribers.

### 14.6.10.1 How to Edit the Recall Time for Calls Transferred to UCD Groups

#### Prerequisites

- You are logged into the WBM with the **Expert** profile.

#### Step by Step

- 1) In the navigation bar, click on **Expert Mode**.
- 2) Click **Telephony > Basic Settings** in the navigation tree.
- 3) In the menu tree, click **Basic Settings > System > Time Parameters**.
- 4) Enter the desired recall time for the time parameter **Monitoring transfer to a UCD group prior to answer** (default setting = 300 seconds). If a call is not answered before this period expires, a recall occurs
  - a) Select the desired time base in the **Base** drop-down list.
  - b) In the **Factor** field, enter the value with which the time base is to be multiplied.
- 5) Click on **Apply** followed by **OK**.

### 14.6.11 Releasing UCD from Analog Lines

When UCD calls over analog lines are not answered within a specific time, these calls are released. This prevents analog lines from freezing up.

The release time is defined via the time parameter **Monitoring a UCD call on an analog line**. The default setting is 300 seconds. This setting (from 0 to 255 minutes) can be changed by an administrator with the **Expert** profile in **Expert mode**.

#### 14.6.11.1 How to Edit the Release Time for UCD Calls over Analog Trunks

#### Prerequisites

- You are logged into the WBM with the **Expert** profile.

***Step by Step***

- 1) In the navigation bar, click on **Expert Mode**.
- 2) Click **Telephony > Basic Settings** in the navigation tree.
- 3) In the menu tree, click **Basic Settings > System > Time Parameters**.
- 4) Enter the desired release time for the time parameter **Monitoring a UCD call to an analog line** (settable from 0 to 255 minutes; default setting = 300 seconds). Calls that are not answered before this time expires are released.
  - a) Select the desired time base in the **Base** drop-down list.
  - b) In the **Factor** field, enter the value with which the time base is to be multiplied.
- 5) Click on **Apply** followed by **OK**.

## 15 Call Routing

The communication system provides several ways to assign calls to a desired destination, such as classes of service (toll restriction), day and night service, least cost routing and Call Admission Control (CAC). Emergency calls can be made from any configuration.

### 15.1 Classes of Service (Toll Restriction)

Classes of service (Toll restriction) control subscriber access to external lines that may be subject to toll charges.

#### 15.1.1 Class of Service (COS) Groups and Classes of Service

Every subscriber is assigned a Class of Service group that defines the class of service (i.e., the permissions) of the subscriber for incoming and outgoing calls.

For each route, one of the following classes of service is defined in the COS group:

- **Internal**  
The subscriber may only make internal calls.
- **Outward-restricted**  
The subscriber may only answer (not make) external calls.
- **Allowed list 1-6**  
The subscriber may only dial the external numbers defined in the Allowed list. Outward-restricted trunk access applies if no call number is entered.
- **Denied list 1-6**  
The subscriber is not permitted to dial the external numbers defined in the Denied list. Unrestricted trunk access applies if no call number is entered.
- **Unrestricted**  
Subscribers can answer and set up incoming and outgoing external calls without restriction.

Some of the 15 possible COS groups are preset with the same class of service for all routes and given meaningful names (e.g., COS group **International** with the class of service **Unrestricted** or COS group **Incoming** with the class of service **Outward-restricted**). The names of all COS groups can be changed by the administrator.

---

**INFO:** By default every station belongs to COS group 7 and this can be changed. Also every trunk belongs to COS group 7 but this is not configurable so as a result COS group 7 should not be used and let it have Unrestricted access to every Trunk Group.

---

### Dependencies

Topic	Dependency
Speed Dials	System speed dial destinations can be selected independently of the assigned COS group.
LCR	The Class of Service Groups (Toll Restriction) and LCR Class of Service are different.
Call forwarding	For forwarded calls, the caller's class of service applies.

### 15.1.1.1 How to Edit COS Group Names

#### Prerequisites

- You are logged into the WBM with the **Expert** profile.

#### Step by Step

- In the navigation bar, click on **Expert Mode**.
- In the navigation tree, click on **Telephony > Classes of Service**.
- Click on **Day: Class of Service Group** in the menu tree.

---

**INFO:** You can also click in the menu tree on **Night: COS group** to achieve the same result.

---

- Click on the desired COS group in the menu tree.
- Click on the **Edit COS Group** tab.
- Enter the name of the COS group in the **Class of Service Group** field.
- Click on **Apply**, followed by **OK**.

### 15.1.1.2 How to Edit the Classes of Service of a COS Group

#### Prerequisites

- You are logged into the WBM with the **Expert** profile.

#### Step by Step

- In the navigation bar, click on **Expert Mode**.
- In the navigation tree, click on **Telephony > Classes of Service**.
- Click on **Day: Class of Service Group** in the menu tree.
- Click on the desired COS group in the menu tree.
- Click on the **Edit COS Group** tab.

- 6) Select to desired class of service for the Day mode for each route being used from the drop-down list.
- 7) If required, select the **Networking** class of service for the Day mode.
- 8) Click on **Night: Class of Service Group** in the menu tree.
- 9) In the menu tree, click on the COS group you have just edited.
- 10) Click on the **Edit COS Group** tab.
- 11) Now select the desired class of service for the Night mode for each route being used from the drop-down list.
- 12) If required, select the **Networking** class of service for the Night mode.
- 13) Click on **Apply**, followed by **OK**.

### 15.1.1.3 How to Display All Stations of a COS Group

#### *Prerequisites*

- You are logged into the WBM with the **Expert** profile.

#### *Step by Step*

- 1) In the navigation bar, click on **Expert Mode**.
- 2) In the navigation tree, click on **Telephony > Classes of Service**.
- 3) Click on **Day: Class of Service Group** in the menu tree.

---

**INFO:** You can also click in the menu tree on **Night: COS group** to achieve the same result.

---

- 4) Click on the desired COS group in the menu tree.
- 5) Click on the **Display COS Member** tab. All subscribers to whom the selected COS group is assigned are displayed with their respective call numbers and names.

## 15.1.2 Allowed and Denied Lists

Allowed and Denied lists are used to define which external phone numbers may and may not be dialed by the subscribers.

**Allowed lists** contain the digit strings permitted at the start of a phone number. The subscriber may only dial the external numbers defined in the Allowed list. Make sure that all required emergency numbers are also included in the list!

**Denied lists** contain the digit strings that are not allowed at the start of a phone number. The subscriber is not permitted to dial the external numbers defined in the Denied list. Make sure that no emergency numbers are included in the list!

## Call Routing

### Classes of Service (Toll Restriction)

The **List of Emergency Numbers** is a special case of the Allowed list. The subscriber may only dial the emergency numbers entered in the list. Make sure that all required emergency numbers are included in the list!

It is not necessary to enter the complete phone numbers in the lists. To permit users to dial (toll free) 0800xxx numbers, for example, only 0800 needs to be entered here. Since these lists are only for outgoing external calls, it is not necessary to include the CO access code with the numbers you enter. Entering a # sign at the start of a denied number prevents the toll restriction from being bypassed for system telephones when an analog CO line is to be seized using DTMF signaling or when switching to DTMF during the dialing.

The Administrator can use **exception filters** for any Denied list to define which digits should not be compared with the corresponding Denied list. The communication system excludes the set range of digits before the digit analysis. By prohibiting the characters \* and #, subscribers are prevented from entering these characters to bypass the toll restriction.

### Configuration Limits

Feature	Number
Allowed list 1: long, 100 entries	1
Allowed lists 2-6: short, 10 entries	5
Denied list: long, 50 entries	1
Denied lists 2-6: short, 10 entries	5
Number of characters in list entries (digits 0 - 9 and the characters * and #)	26

## 15.1.2.1 How to Create a List of Emergency Numbers

You can create a list of emergency numbers for the "Emergency Numbers" COS group with the **Class of Service** wizard.

### Prerequisites

- You are logged in at the WBM.
- Your communication system is connected to a trunk.

### Step by Step

- 1) In the navigation bar, click on **Setup**.
- 2) In the navigation tree, click **Wizards > User Telephony**.
- 3) Click on **Edit** to start the **Classes of Service** wizard.
- 4) Enter an emergency phone number in the input field and click on **Add**. The phone number is added to the list of emergency numbers.
- 5) If you want to enter more numbers into the list of emergency numbers, repeat the previous step.

- 6) Keep clicking on **OK & Next** until you complete the configuration with **Finish**.

### 15.1.2.2 How to Create an Allowed and a Denied List

You can create an Allowed and a Denied list with the **Class of Service** wizard.

#### *Prerequisites*

- You are logged in at the WBM.
- Your communication system is connected to a trunk.

#### *Step by Step*

- 1) In the navigation bar, click on **Setup**.
- 2) In the navigation tree, click **Wizards > User Telephony**.
- 3) Click on **Edit** to start the **Classes of Service** wizard.
- 4) Click on **OK & Next**.
- 5) Enter an allowed phone number without the CO access code in the input field and click on **Add**. The phone number is added to the Allowed list.
- 6) If you want to enter more numbers into the Allowed list, repeat the previous step.
- 7) Click on **OK & Next**.
- 8) Enter an denied phone number without the CO access code in the input field and click on **Add**. The phone number is added to the Denied list.
- 9) If you want to enter more numbers into the Denied list, repeat the previous step.
- 10) Keep clicking on **OK & Next** until you complete the configuration with **Finish**.

### 15.1.2.3 How to Create Additional Allowed Lists

#### *Prerequisites*

- You are logged into the WBM with the **Expert** profile.

#### *Step by Step*

- 1) In the navigation bar, click on **Expert Mode**.
- 2) In the navigation tree, click on **Telephony > Classes of Service**.
- 3) Click **Classes of Service > Allowed Lists** in the menu tree.
- 4) Click on the desired allowed list in the menu tree.
- 5) Click on the **Add Station Number** tab.
- 6) Enter the external **Call number** without the seizure code.

## Call Routing

### Classes of Service (Toll Restriction)

- 7) Click on **Apply**, followed by **OK**.
- 8) If you want to add more call numbers, repeat steps 6 and 7.
- 9) If you want to create additional allowed lists, repeat steps 4 through 7.
- 10) You can view all the phone numbers of the selected Allowed list on the **Display List** tab.

#### 15.1.2.4 How to Create Additional Denied Lists

##### *Prerequisites*

- You are logged into the WBM with the **Expert** profile.

##### *Step by Step*

- 1) In the navigation bar, click on **Expert Mode**.
- 2) In the navigation tree, click on **Telephony > Classes of Service**.
- 3) Click **Classes of Service > Denied Lists** in the menu tree.
- 4) Click on the desired denied list in the menu tree.
- 5) Click on the **Add Station Number** tab.
- 6) Enter the external **Call number** without the seizure code.
- 7) Click on **Apply**, followed by **OK**.
- 8) If you want to add more call numbers, repeat steps 6 and 7.
- 9) If you want to create additional denied lists, repeat steps 4 through 7.
- 10) You can view all the phone numbers of the selected Denied list on the **Display List** tab.

#### 15.1.2.5 How to Display all Call Numbers in a Denied List

##### *Prerequisites*

- You are logged into the WBM with the **Expert** profile.

##### *Step by Step*

- 1) In the navigation bar, click on **Expert Mode**.
- 2) In the navigation tree, click on **Telephony > Classes of Service**.
- 3) Click **Classes of Service > Denied Lists** in the menu tree.
- 4) Click the desired number on the Denied List in the menu tree.



### 15.1.2.6 How to Display all Call Numbers in an Allowed List

#### *Prerequisites*

- You are logged into the WBM with the **Expert** profile.

#### *Step by Step*

- 1) In the navigation bar, click on **Expert Mode**.
- 2) In the navigation tree, click on **Telephony > Classes of Service**.
- 3) Click **Classes of Service > Allowed Lists** in the menu tree.
- 4) Click on the desired number on the Allowed List in the menu tree.

### 15.1.2.7 How to Edit the Analysis Filter for the Denied List

#### *Prerequisites*

- You are logged into the WBM with the **Expert** profile.

#### *Step by Step*

- 1) In the navigation bar, click on **Expert Mode**.
- 2) In the navigation tree, click on **Telephony > Classes of Service**.
- 3) Click **Classes of Service > Denied Lists** in the menu tree.
- 4) Click the desired number on the Denied List in the menu tree.
- 5) Click on the **Edit Analysis Filter** tab.
- 6) Select a range in the **From digit** and **To digit** drop-down lists.

This enables a range within a call number to be configured. The starting position of the range is selected via the **From digit** drop-down list and the end position via **To digit**.

The default setting of \* and # for this field is intended as a means of blocking these characters, since \* and # could be used as "dummy" characters, which are not evaluated in the Central Office and would thus bypass the toll restriction. Entering \* and # in the Denied list causes these characters have no effect, so only the dialed digits are evaluated.

- 7) Enter the character(s) to be hidden in the **Character** field.
- 8) Click on **Apply** followed by **OK**.

## 15.1.3 Night Service

During the night, incoming and outgoing calls can be treated differently than during the day. Incoming calls can be redirected to a night service destination, and internal subscribers can have different classes of service for their phones than

## Call Routing

### Classes of Service (Toll Restriction)

during the day. The system-wide switching between the day and night service is performed automatically at a time specified by the administrator.

Any phone can serve as a night service destination, provided the associated class of service group allows incoming calls. A telephone with internal authorization only cannot be entered as a night service destination. If the night service destination has activated call forwarding, this is followed.

In order to prevent toll fraud, for example, a COS group can be assigned different classes of service for the night and day modes.

In addition, you can also specify a different intercept position for the night service as opposed to the day service. This intercept position can be an individual station or a group.

### Scheduled Night Service

The communication system activates and deactivates the night service in accordance with a schedule defined by the administrator.

---

**INFO:** With the scheduled night service, the active settings apply to ALL stations of the communication system. In the case of automatic COS changeover after time, all subscribers are combined into groups (profiles).

---

### Variable Night Service

The variable night service is activated and deactivated manually by an authorized subscriber. The calls are handled as configured by the administrator in the call destination lists

By default, the first subscriber (with the station number "100") in the communication system can activate and deactivate the night service. The administrator can authorize up to five subscribers to activate and deactivate the night service.

### UCD Night Service

An individual night service can be configured for every UCD group. It can be activated and deactivated independently of the system-wide night service. It can also be activated and deactivated by every agent in a UCD group. The current status of the individual agents and existing calls are not affected. Following activation, all calls for this UCD group are forwarded to the night service destination.

Another UCD group, an internal station or an external destination can all be set as a night service destination.

## 15.1.3.1 How to Assign Classes of Service for the (Manual) Night Service

You can use the **Classes of Service** wizard to assign individual subscribers the authorization to switch the communication system from the day to night service

(and vice versa) via their telephones. The switch between day and night service occurs via the telephone by using a code.

### ***Prerequisites***

- You are logged in at the WBM. Your communication system is connected to a trunk.

### ***Step by Step***

- 1) In the navigation bar, click on **Setup**.
- 2) In the navigation tree, click **Wizards > User Telephony**.
- 3) Click on **Edit** to start the **Classes of Service** wizard.
- 4) Click on **OK & Next** until you see the **Authorized station for night service** window.
- 5) Mark the desired station in the list under **Stations** and click **Add**. The station will then appear in the list under **Authorized station**.
- 6) Click on **OK & Next**.
- 7) A list of all authorizations (classes of service) appears in the **System Overview** window.
- 8) Click on **Finish**.

## **15.1.3.2 How to Delete Classes of Service for the Manual Night Service**

The **Classes of Service** wizard can be used to delete the authorization of a station to switch from the day to night service.

### ***Prerequisites***

- You are logged in at the WBM. Your communication system is connected to a trunk.

### ***Step by Step***

- 1) In the navigation bar, click on **Setup**.
- 2) In the navigation tree, click **Wizards > User Telephony**.
- 3) Click on **Edit** to start the **Classes of Service** wizard.
- 4) Click on **OK & Next** until you see the **Authorized station for night service** window.
- 5) Mark the desired station (whose class of service you want to delete) in the list under **Authorized station** and click **Delete**.
- 6) Click on **OK & Next**.
- 7) A list of all authorizations (classes of service) appears in the **System Overview** window.

## Call Routing

### Classes of Service (Toll Restriction)

- 8) Click on **Finish**.

### 15.1.3.3 How to Configure the Scheduled Night Service

#### *Prerequisites*

- You are logged into the WBM with the **Expert** profile.

#### *Step by Step*

- 1) In the navigation bar, click on **Expert Mode**.
- 2) In the navigation tree, click on **Telephony > Classes of Service**.
- 3) Click in the menu tree on **Autom. night service > Monday** (Monday is just an example; all days of the week are available).
- 4) Under **Edit Zone**, select one of four possible zones to which a specific Class of Service should apply.
- 5) Specify the time (in hours and minutes) for this class of service with **Start** and **End**.
- 6) Under **Night Call no.**, select the authorized subscriber.  
Your settings for each zone will be displayed in the **Autom. night service** field.
- 7) Click on **Apply** followed by **OK**.

### 15.1.3.4 How to Configure a Special Day for the Scheduled Night Service

#### *Prerequisites*

- You are logged into the WBM with the **Expert** profile.

#### *Step by Step*

- 1) In the navigation bar, click on **Expert Mode**.
- 2) In the navigation tree, click on **Telephony > Classes of Service**.
- 3) Click **Classes of Service > Special Days** in the menu tree.
- 4) Select the year for which you want to define a holiday by using **>>** or **<<**.
- 5) Then use **>>** or **<<** to select the month for that holiday.
- 6) Then click in the calendar on the day to be defined as a holiday.
- 7) Enter a designation for the holiday under **Name**.
- 8) Click on **Apply** followed by **OK**.

### 15.1.3.5 How to Delete a Special Day for the Scheduled Night Service

#### *Prerequisites*

- You are logged into the WBM with the **Expert** profile.

#### *Step by Step*

- 1) In the navigation bar, click on **Expert Mode**.
- 2) In the navigation tree, click on **Telephony > Classes of Service**.
- 3) Click **Classes of Service > Autom. night service > Special Days** in the menu tree.
- 4) Under **Day**, click on the trash can to the left of the holiday to be deleted.
- 5) Click on **Apply**, followed by **OK**.

### 15.1.4 Automatic COS Changeover after Time

For the "automatic COS changeover after time", the stations are grouped into so-called station profiles that define which COS group applies in which time interval of the week. For each station profile, you can configure a schedule.

Differences between "automatic COS changeover after time" and the "scheduled night service":

- Automatic COS changeover after time applies only to the day service (not the night service).
- Reaching the call destination via Call Management  
This takes place via Call Management and does not depend on automatic class-of-service changeover. There are different call lists for day and night.
- With the scheduled night service, a distinction can only be made between day and night shifts, and this applies to ALL stations.
- Intercept destinations  
The intercept destination is only defined by the scheduled night service.
- COS group:  
During the night, the COS group is in a constant (configurable) relationship with the station; the automatic class of service changeover after a timeout has no impact on this.  
During the day, the COS group may be changed during certain times of the day or also be in a fixed (configurable) relationship with the subscriber.

**Call Routing**

Classes of Service (Toll Restriction)

**Dependencies**

Topic	Dependencies
Night service	The "Automatic Night Service" feature has priority over the "Automatic COS Changeover after Time" feature. If the night service is activated, the COS group is handled normally and applied for the night. The schedule is only relevant during the day.
Networking	Automatic COS changeover and night service do not function across all nodes.

**15.1.4.1 Schedule**

The schedule is used to control the Classes of Service for the "automatic COS changeover after time". It is possible to configure up to eight COS changeovers per day for each day of the week.

Each day begins at 00:00 hours. Entering the end time time in each of the columns delineates the time zones. In the following example of a schedule, the individual COS changeovers are referred to as CG2, CG4 and CG5.

A station can have different class of service groups for the day and night.

If "Automatic COS changeover" is set system-wide for the day, the profile and schedule that is configured will determine the COS group that is assigned to a

station. At night, the station has the same COS group as previously assigned (via the night service).

Automatic COS changeover after time is disabled by default

The communication system supports only one time zone (world time). Remote station groups working in different time zones are set to the communication system's time zone.

The schedule can only be configured using Manager E.

## 15.1.5 CON Groups

The CON Groups feature is used to define which subscribers of the communication system can establish connections to which other subscribers of the communication system. This feature is used for tenant systems, for example.

CON groups can also be used to configure which lines individual subscribers can access for incoming and outgoing calls..

The CON functionality does not access the applications; it is only significant for telephony. The presentation of the presence status, for example, is not prevented by an access restriction through CON.

The CON feature is implemented in two steps:

- Create CON groups
- Configure CON matrix

---

**INFO:** The CON feature should not be used in conjunction with UC functionality, since this could result in limitations.

---

### 15.1.5.1 CON groups (traffic restriction groups)

CON groups (also referred to as traffic restriction groups) control allowed and denied connections between subscribers and lines of the communication system.

Using CON groups, specific stations and lines can be combined into groups.

You can assign a CON group to individual stations and lines in the communication system via the CON Group Assignment. When coding the connection matrix, you can then access these groups and define which subscribers can reach which other subscribers and which lines can be accessed by them.

All stations and CO trunks are assigned to CON group 1 by default. This provides all subscribers with unrestricted access to other subscribers as well as trunks, both incoming and outgoing. The CON matrix specifies which of the six CON groups can set up connections to which other CON groups.

A maximum of 64 CON groups can be configured.

### 15.1.5.2 Assigning Speed-Dialing Numbers to CON groups

Every CON group is assigned a range of System Speed Dialing (SSD) destinations. When a subscriber dials an SSD, the associated CON group is checked to verify if the subscriber is authorized to do so. Dialing is performed if this speed-dialing number lies within the correct range for the relevant CON group, otherwise an error message is output.

When a user dials a speed-dial number, the system identifies the ITR group for the number, which determines whether or not the user is authorized to dial that number. If not, an error message appears, and the dialing attempt is rejected

Speed-dial number ranges can overlap in the ITR groups.

By default, all speed-dial numbers are assigned to ITR group 1.

The speed-dial number ranges can overlap in the CON group. The following are permitted, for example:

CON group	SSD range
1	0000-7999
2	0050-0150
3	0200-0500

Please note, however, that you cannot enter individual system speed-dial (SSD) numbers or multiple SSD ranges in a CON group instead of a range. The following are not permitted, for example:

CON group	SSD range
1	0000, 0005, 0010
2	0050-0100, 0300-0500

### 15.1.5.3 How to Assign Stations to a CON Group

#### Prerequisites

- You are logged into the WBM with the **Expert** profile.

#### Step by Step

- 1) In the navigation bar, click on **Expert Mode**.
- 2) In the navigation tree, click on **Telephony > Classes of Service**.
- 3) Click **Classes of Service > CON Group Assignment > CON Group Assignment** in the menu tree.
- 4) Select the entry with the desired traffic restriction group for one of the stations displayed in the **Stations** column in the **Group** drop-down list.
- 5) Click on **Apply**, followed by **OK**.



### 15.1.5.4 How to Assign a Trunk to a CON Group

#### *Prerequisites*

- You are logged into the WBM with the **Expert** profile.

#### *Step by Step*

- 1) In the navigation bar, click on **Expert Mode**.
- 2) In the navigation tree, click on **Telephony > Classes of Service**.
- 3) Click **Classes of Service > CON Group Assignment > Trunk to CON Group** in the menu tree.
- 4) Select the entry with the desired traffic restriction group for one of the trunks displayed in the **Trunks** column in the **Group** drop-down list.
- 5) Click on **Apply**, followed by **OK**.

### 15.1.5.5 How to Edit the CON Matrix

#### *Prerequisites*

- You are logged into the WBM with the **Expert** profile.

#### *Step by Step*

- 1) In the navigation bar, click on **Expert Mode**.
- 2) In the navigation tree, click on **Telephony > Classes of Service**.
- 3) Click on **Classes of Service > CON Matrix** in the menu tree.
- 4) Edit the connection options as follows:
  - If you want to block all connection methods, click **Block all**.
  - If you want to release all connection methods, click **Release all**.
  - If you want to release only the group-internal connection methods, click **Group-internal only**.
  - If you want to selectively edit one connection method between two CON groups, click in the field at the intersection point of these CON groups in the CON matrix. Click repeatedly in the field to release or block the connection methods in one direction, the other direction, or both directions.
- 5) Click on **Apply** followed by **OK**.

## 15.1.6 System Telephone Lock (COS Changeover)

The central lock code enables an authorized subscriber (possibly the administrator) to set a comprehensive lock on most of the phone functions for

## Call Routing

### Classes of Service (Toll Restriction)

other subscribers. Only the following features are still available: internal calls, system speed dialing and conferencing with internal subscribers. This lock code can be deactivated by either the authorized subscriber or the locked subscriber by entering their own lock codes.

The lock code of the phone for the which the lock is to be activated or deactivated by the authorized subscriber is not required to set the lock.

By default, the authorized subscriber is the subscriber with the call number "100" (reconfigured).

## 15.1.7 Individual Lock Code (Locking the Phone)

If the individual telephone lock is set for a phone, external calls cannot be conducted from that phone, and the user settings cannot be modified.

Emergency numbers can be dialed even if the phone is locked.

You can still conduct internal calls.

Incoming calls can be redirected to internal subscribers.

A locked telephone only supports features that do not require external dialing. The System Speed Dialing feature is the exception to this rule.

To remind subscribers that the station is locked, the phone receives a steady tone (special dial tone). In addition, on phones equipped with a display, the message "Unlock Phone" appears.

Subscribers can lock their phones via a key or code by entering their personal lock codes and then unlock the phone again as required.

The phone lock code must be configured first before the phone lock can be used. The phone lock code is set to 00000 by default for all phones and can be set individually. To do this, the must be unlocked. The phone lock code must always be 5 digits. Only digits 0-9 are allowed. If the subscriber has forgotten the phone lock code, he or she can have it reset to the default value 00000 by an authorized user (i.e., the first station in the system with the call number "100" or the administrator).

### 15.1.7.1 How to Reset the Individual Lock Code

Use the **Station name and release** wizard to reset the individual lock code on a phone.

#### *Prerequisites*

- You are logged on to the WBM with the **Advanced** profile.

### ***Step by Step***

- 1) In the navigation bar, click on **Setup**.
- 2) In the navigation tree, click **Wizards > User Telephony**.
- 3) Click **Edit** to start the **Station Name and Release** wizard. The **Name Configuration and Unlock for Stations and Groups** window appears.
- 4) Enable the check box **System telephone lock reset**.
- 5) Click **OK & Next** followed by **Finish**.

## **15.1.8 Collect Call Barring per Trunk (for Brazil only)**

Collect call barring per trunk provides for automatic release of incoming collect calls. This feature is available only in the country settings for Brazil. The setting is ignored in all other countries.

Users can configure it individually for each analog trunk. Ringback protection can be configured individually for each analog trunk. If this feature is enabled for a trunk, the system opens the loop for two seconds (default value) one second (default value) after an incoming call is accepted. This ensures that collect calls are released in the network, while other calls continue unaffected.

## **15.1.9 Ringback Protection per Station (for Brazil only)**

Ringback protection per station (also called call collect barring per station) makes it possible to set up ringback protection individually for each station, thus making it possible to automatically refuse incoming ringback calls. This also applies in the case of call forwarding, call pickup, an intercept, etc.

Users can also program collect call barring system-wide. This applies if a caller dials a hunt group instead of an individual station or misdials a number.

## **15.2 LCR (Least Cost Routing)**

The Least Cost Routing (LCR) function automatically controls the paths used for routing an outgoing connection. This path can be routed via the public network, various network providers (ITSPs) or a private network. The most suitable connection path is selected for a call on the basis of the dial plan, route tables, and outdial rules.

Connections can be voice calls, analog data connections via fax and modem and ISDN data connections.

## 15.2.1 LCR Functionality

You can use the LCR function to specify the provider you want to use, for example, for local calls, mobile phone calls or international calls. You use the communication system to define the least-cost provider and conduct all calls via this specific path.

If a pattern that matches the dialed phone number is found in the dial plan, the route tables are searched for a suitable route (Each trunk is assigned to a route. See [CO Access over Digital and Analog Lines](#)). At the same time, the system checks if the LCR class of service applies to this route table entry. The LCR class of service and the difference between LCR and toll restriction are described in LCR Class of Service section.

The LCR function provides control over which stations of the communication system may use which routes or trunks (to ensure that faxes are routed exclusively via TDM trunks and not via ITSPs, for instance). It is also checked whether the caller has the required class of service as per the toll restriction to seize the route under consideration by LCR. This check can be disabled for tie trunks (PABX trunks) via the configuration.

The dialed digits are buffered until the routing tables with the LCR classes of service have been evaluated. It is only on completing this step that the connection is set up, in accordance with the outdial rules. A dial tone can be issued to signal the ready-to-dial condition to the subscriber.

When configuring outdial rules, you can enter information for the dialing station, e.g., by specifying that this connection is routed via a specific telephony provider (name of the provider) or that a connection is using a more expensive route. This information can either be displayed on the screen, output as a tone or output both on the display and as a tone.

In general:

- When LCR is activated, the check is performed for every external dialing operation. Exception: when dialing a specific trunk code or line key.
- If LCR determines that the preferred route cannot be used, the communication system will look for a (possibly more expensive) alternative from the routing table.
- Digits can be transmitted either individually or en-bloc, depending on the access method and the route table.
- If the table of DID numbers is empty, the table of internal call numbers is alternatively used. The corresponding rules apply to this table.

---

**INFO:** The location number (country code / possibly local area code / possibly PABX number) must be configured even for communication systems with analog trunks (MSI).

In addition, a DID number or, if the DID number table is empty, a DID number of the own analog trunk connection (MSI) must be configured. This is the only way to ensure that all external destinations can be reached.

---

### System-Specific Information

The communication system evaluates a total of 24 characters.

The communication system can manage up to 1000 dial plans and 254 route tables with 16 entries each.

### LCR Flowchart

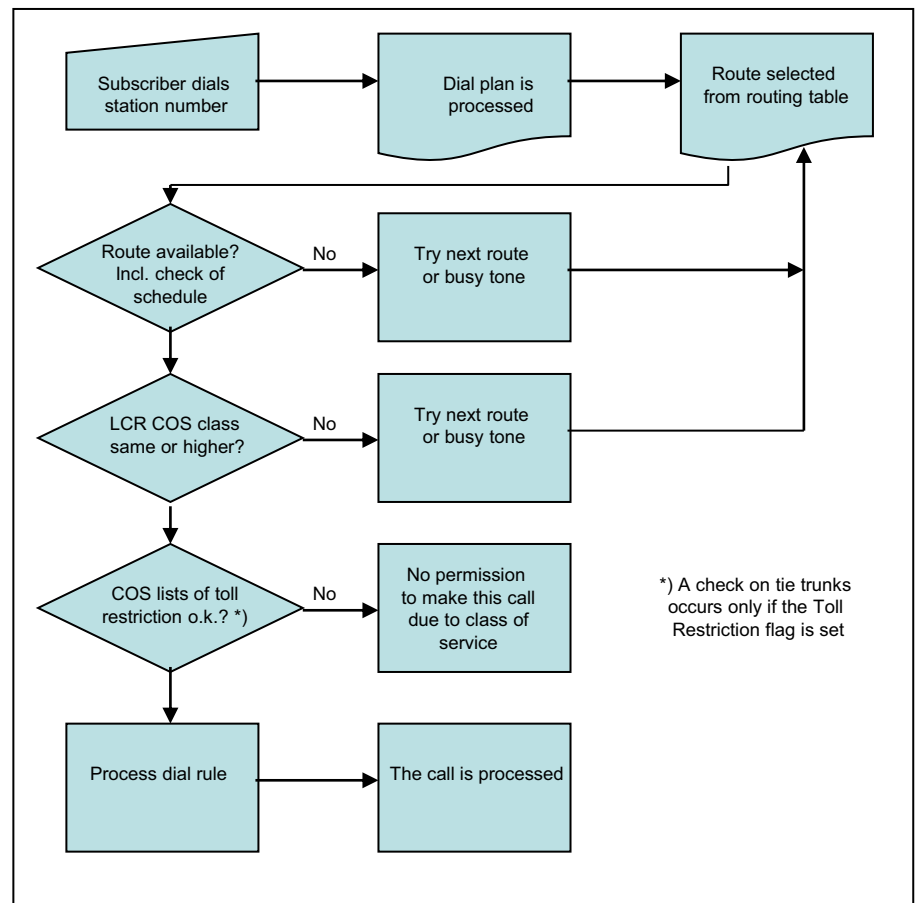

### Digit transmission

There are two types of digit transmission: digit-by-digit and en-bloc sending. For digit-by-digit transmissions, each digit is transmitted and processed directly after dialing (prerequisites: the LCR analysis is complete, the dial plan entry is uniquely identified, and the classes of service have been checked). With block dialing, digit blocks are formed and transmitted as a block (i.e., line seizure occurs only after some time or when an explicit end-of-dialing code is recognized).

The digit transmission for ITSP routes must always be en-bloc. The setting of the route applies to the entire routing table.

### For U.S. only: Carrier Select Override

Carrier Select Override can be implemented through selective line seizure (code, key). The LCR mechanism is bypassed completely in this case.

## Dependencies

Topic	Dependency
Schedule	If an LCR configuration with a schedule exists in a system migrated from HiPath 3000, these entries are still effective and can be administered with Manager E.
System Speed Dialing	To ensure that system speed dial destinations work properly, the LCR access code, followed by the destination number, must be entered in the speed-dial destination.
Name keys	Repertory dial keys to external destinations must have the LCR access code for proper operation.
Class of service (Toll restriction)	The toll restriction classes of service are also applied in LCR. For PBX trunks, the toll restriction can be disabled; the configuration occurs via a flag.
Prime Line	If Prime Line to the CO is used, no LCR is possible. These features are not mutually compatible.

### 15.2.1.1 How to Release LCR

#### Prerequisites

- You are logged into the WBM with the **Expert** profile.

---

**INFO:** Some entries such as the local area code or station numbers will have already been created in the **Basic Installation** wizard. Manual changes to these entries should only be made by trained technician. An invalid configuration in the LCR could potentially prevent or restrict outgoing connections.

---

#### Step by Step

- 1) In the navigation bar, click on **Expert Mode**.
- 2) In the navigation tree, click **Telephony > LCR**.
- 3) Click on the **Edit LCR Flags** tab.
- 4) Select the **Activate LCR** check box.
- 5) Click on **Apply** followed by **OK**.

### 15.2.2 LCR Dial Plan

The dial plan is searched for patterns that match the dialed digits (dialing sequence). The result is used as a criterion for selecting the route table. At the same time, the system checks if the subscriber's LCR class of service matches for this dial plan entry.

The pattern of a dialing sequence is assigned in the dial plan to a routing table which, in turn, determines further parameters for the connection setup.

The dial plan is split into individual fields for identification and configuration purposes. The table shows the numbers 4922000 and 1603656260 entered in the dial-plan table.

Field 1	Field 2	Field 3	Field 4	Field 5
0	C 492	– 2000		
0	C 160	– 365	– 62	– 60

**The following entries apply for the phone numbers:**

- 0 . . . 9      Allowed digits
- Field separator
- C              Simulated dial tone (can be entered up to three times). This entry is also interpreted as a field separator

**Global character**

- X              Any digit from 0 to . . 9
- N              Any digit from 2 to . . 9
- Z              One or more digits to follow up to the end of dialing

A digit sequence can be divided into a maximum of 10 fields.

Field separators are used to split the digit string into individual fields that can be evaluated separately. Example: After the first dialed digit, a separator is inserted so that a dialed "0" is detected as a separate field and thus simulates toll restriction.

Due to this field separation, these fields can be repeated or rearranged in the dial plan. The fields formed by the field separators "-" and "C" in the dial plan can be addressed selectively to repeat, suppress, exchange, or insert digits.

A "#" or "\*" character in the digit string dialed by the subscriber is the end-of-dial code or indicates dialing method changeover. This is why these characters are not valid entries in the dial plan.

Specific dialed numbers must precede wildcard entries to prevent conflicts in matches with wildcard entries.

The account code entry can be enforced per dial plan. The Account Code Checking Procedure applies.

If there are multiple dial plan entries that match a a dial string, the closest match is used. Example: If 00894711 is dialed, and dial plan entries 0CZ and 0C089Z exist -> 0C089Z will be executed. The position of the entries within the dial plan is irrelevant; no "sorted" entry is required.

OpenScape Business can evaluate a dialing sequence of up to 24 characters.

### **LCR Entries for Initial Setup of the Communication System**

When the communication system is started up for the first time, a number of country-specific default values are entered in the LCR dial plan. Up to and including dial plan 34, system-side entries for emergency calls, directory assistance, special numbers, default trunk seizure for PSTN and ITSP, for UC Suite, announcement connections, networking and for international dialing formats are preset to ISDN trunks. This range can be affected by configuration changes elsewhere (for example, by changes to the **Location number** flag). Consequently, whenever the location number is changed, it must be ensured that the default trunk seizure still works as expected (which is important when dialing public numbers).

---

**INFO:** From LCR dial plan 36 onwards, all entries are freely available.

---

## **15.2.2.1 How to Edit the Dial Plan**

### **Prerequisites**

- You are logged into the WBM with the **Expert** profile.

### **Step by Step**

- 1) In the navigation bar, click on **Expert Mode**.
- 2) In the navigation tree, click **Telephony > LCR**.
- 3) Click on **Dial Plan**.
- 4) The individual dial plans are listed under **Change Dial Plan** and you can edit the following fields:
  - **Name**
  - **Dialed digits**
  - **Route table**
  - **Acc. code**
  - **Toll restriction**  
The toll restriction flag is only relevant for the route type PABX. It has no meaning for the route type CO; this means that it is not possible to disable toll restriction for CO trunks here.
  - **Emergency**

---

**INFO:** Click on the blue arrow next to the **Route table** field opens the associated routing table.

---

- 5) Click on **Apply** followed by **OK**



## 15.2.3 LCR Routing Table

Least Cost Routing (LCR) is achieved by searching for a suitable route in the LCR routing tables (every trunk must be assigned a route). At the same time, the system checks if the class of service (toll restriction) matches for this route. The outdial rule is also dependent on the assigned path.

The routing table describes:

- the route assigned to the relevant path.
- the outdial rule,
- the LCR Class of Service (COS) required for seizure,
- the warning method for a more expensive route (warning tone).
- the dedicated gateway and
- the GW node ID.

The table is searched from top to bottom in hierarchical order. The system checks to determine whether the route is free and the station has the requisite LCR class of service. If this is the case, dialing occurs according to the dial rule entered in the route table if this is permitted by the toll restriction class of service and the CON group assignment between the subscriber and the line.

If the first route selection in the route table is busy, the LCR function can advance to the next (possibly more expensive) route configured in the route group table. The system can notify the user of this with an audible signal, an optical signal, or both.

Up to 254 route tables with 16 routes each can be created.

### Dedicated Gateway

A dedicated gateway is a fixed partner node in an IP internetwork (Dedicated Gateway -> Forced). When a dedicated gateway with the corresponding GW node ID is entered for the IP networking route, routing to this gateway is enforced.

In a multi-gateway configuration, a dedicated gateway is determined via the subscriber configuration.

### 15.2.3.1 How to Edit Routing Tables

#### *Prerequisites*

- You are logged into the WBM with the **Expert** profile.

#### *Step by Step*

- 1) In the navigation bar, click on **Expert Mode**.
- 2) In the navigation tree, click **Telephony > LCR**.
- 3) Click on **Route table**.
- 4) All routing tables are displayed for you:

- **1-Table**
- **2-Table**
- **nn-Table**

---

**INFO:** Routing tables 1 to 15 are intended for default entries or for configuration using wizards. During a migration, the existing entries are automatically entered into these routing tables.

However, this mechanism does not prevent any duplicates in the entries. Manual post-processing of the routing tables is therefore recommended.

---

- 5) Click on the desired routing table. The selected table with the **Change Routing table** tab is displayed.
- 6) The individual routing tables are listed under **Change Routing table** and you can edit the following fields:
  - **Route**
  - **Dial Rule**

---

**INFO:** By clicking on the blue arrow next to the desired rule, you can view and edit the dial rule properties.

---

- **min. COS (LCR Class of Service)**
  - **Warning**
  - **Dedicated Gateway**
  - **GW Node ID**
- 7) Click on **Apply** followed by **OK**.

## 15.2.4 LCR Class of Service

Every subscriber is assigned a separate LCR class of service (COS). A subscriber can only seize a route if his or her COS is greater than or equal to the LCR COS in the route table, i.e., a subscriber with a COS 7 cannot seize a route with COS 8. By default, all subscribers are entered with the maximum LCR Class of Service (15).

## Dependencies

Topic	Dependency
Toll restriction	The Toll Restriction class of service has precedence over the LCR class of service. The Toll Restriction class of service can be enabled and disabled for tie trunks.
CON Group Assignment	Dialing occurs only if allowed by the CON matrix.

### 15.2.4.1 How to Assign and Change an LCR Class of Service

#### *Prerequisites*

- You are logged into the WBM with the **Expert** profile.

#### *Step by Step*

- 1) In the navigation bar, click on **Expert Mode**.
- 2) In the navigation tree, click **Telephony > LCR**.
- 3) Click on **Classes Of Service**.
- 4) Assign an LCR class of service under **Edit LCR Class of Service** in the **Class of Service** field or edit an existing class of service.

This only applies to the class of service of a subscriber for LCR. The field has no effect on the toll restriction.

- 5) Click on **Apply** followed by **OK**.

### 15.2.5 LCR Outdial Rules

LCR outdial rules can be used to convert the phone numbers entered into random new digit strings for additional processing. Access to different carriers is enabled via digit translation. The dial rule used is defined by the path or the route in the route table.

#### **System-Specific Information**

The communication system can administer up to 254 outdial rules in the LCR dialing rules table. The name of a dial rule can contain up to 16 characters.

The dialing rules address the dial plan fields selectively for the following operations:

- Repeating digits
- Suppressing digits
- Exchanging digits
- Inserting digits
- Switching the signaling method

- Detecting a dial tone
- Inserting pauses

### **Dial Rule**

You can define up to 254 outdial rules here with a maximum length of 40 characters each.

The LCR dialing rules table is also referred to as the routing table.

### **Definition of Outdial Rules (Dial Rule Format)**

- **A:**  
Repeat remaining fields (transmit). The letter "A" causes all subsequent digit fields to be transmitted. The point of reference is the last field delimiter in the field of dialed digits in the dial plan.  
If "A" is entered without an explicit reference, it designates all digits after the access code, i.e., "A" is then equivalent to "E2A".
- **B:**  
It is used for the multi-gateway network when a station number of type TON (Type Of Number) that was called from outside is "unknown" and must be routed to the multi-gateway node. To ensure that this station number is unique, it is extended to national or international in accordance with the TON in the LCR. This is required when the DID numbers are not unique and need to be configured in the national or international format.
- **D (n):**  
Dial digit sequence (1 to 25 digits). "D" may occur multiple times and at any position in the string.
- **E (n):**  
Transmit field contents (1 to 10). "E" may occur multiple times and at any position in the string. "E" can also appear in any order with relation to (n). A specific field can be addressed multiple times, including in sequence. With the exception of "E1" (access code), this letter can be surrounded by any parameters.  
With digit-by-digit dialing (opposite of en-bloc dialing), the last element in the outdial rule cannot be E(n); it may be E(n)A.
- **M (n):**  
Authorization code (1 to 16). This letter must not be in the final position.
- **P (n):**  
P (n) can occur more than once in the string and can be placed in any position. P (n) can be surrounded by any other parameters.(1 to 60 times the system-wide pause unit).
- **S:**  
Switch, changes signaling methods from DP to DTMF (with CONNECT, PROGRESS or CALL PROC with PI). The letter "S" may occur in the string only once and must not be in the final position. The "C" parameter cannot be used after "S".

- **C:**  
Carrier "C" can be inserted in the string only once. The subsequent characters are transmitted without a dial pause and are used for single stage, two-stage, DICS (not for U.S.), BRI, and PRI carrier access.
- **U:**  
Use subaddress signaling method. The letter "U" may occur in the string only once and must not be in the final position. The "S", "P", "M", and "C" parameters cannot be used after "U".
- **N (n) (only for the U.S.):**  
Network SFG (1 to 5) or Band Number (1).
- **L (for U.S. only!):**  
"L" must only occur at the end of a string of characters. "L" causes the call to be handled as an emergency call.

**Example:**

The system should automatically add a provider suffix.

Dial rule D010xxA means: the system first dials the Provider prefix (010xx), and then all the digits after the access code dialed by the subscriber (A).

### 15.2.5.1 How to Edit the Outdial Rules

**Prerequisites**

- You are logged into the WBM with the **Expert** profile.

**Step by Step**

- 1) In the navigation bar, click on **Expert Mode**.
- 2) In the navigation tree, click **Telephony > LCR**.
- 3) Click on **Dial rule**. All outdial rules are displayed for you.
- 4) Click on the desired dial rule in the menu tree.
- 5) You can edit the following fields:
  - **Rule Name**
  - **Dial rule format**
  - **Network provider's method of access (Unknown, Main network supplier, MCL Single Stage, MCL Two Stage, Corporate Network, Dial In Control Server, Primary Rate Interface)**
  - **Type (Unknown, Country code, Area code, PABX number)**
- 6) Click on **Apply** followed by **OK**.

## 15.2.6 Network carriers

You can assign network carriers to each route. The selection of the network carrier is defined by the LCR outdial rules.

### **Unknown**

No explicit specification about a network carrier.

### **Main network supplier**

When seizing a trunk using the main network supplier, simplified dialing into the public network is performed by en-bloc dialing or by dialing individual digits.

### **MCL Single Stage**

With MCL Single Stage, a prefix is used to dial the desired network carrier, and the station number is then dialed. Dialing occurs in the D channel for ISDN or as normal dialing for MSI.

### **MCL Two-Stage**

With MCL Two Stage, a prefix is used to dial the desired network carrier. After a synchronization phase, a configurable authorization code is initially sent followed by the destination call number as DTMF digits.

With synchronization during timeout, you must program a pause of 2 to 12 seconds.

### **Corporate Network**

A corporate network is directly connected to the communication system. The LCR function determines the appropriate trunk group based on the station number dialed and then routes the call either via the trunk group in the public exchange or via the trunk group in the corporate network.

### **Dial-In Control Server**

With this type of LCR, the desired network carrier is dialed with a prefix via a dial-in control server, and the call number and configurable authorization code are transmitted in the subaddress. Dialing occurs in the D channel.

### **Primary Rate Interface (PRI) (U.S. only)**

In the case of the Primary Rate Interface, the selection of the network carrier or of a calling service is encoded in SETUP message using following information elements: Network Specific Facility, Operator System Access and Transit Network Selection.

## Dependencies

Topic	Dependency
Receiving/forwarding call information	Temporary or permanent station number suppression cannot be activated.
ISDN/SUB addressing	The ISDN feature SUB must be applied for or released in the public network.

## 15.2.7 Selective Seizure of Exchange Lines

Exchange lines (aka "outside lines" or "CO trunks") can also be seized selectively by subscribers.

The prioritization for the seizure of exchange lines is handled via Least Cost Routing by default. In most cases, the least-cost provider is selected first, followed by the second-lowest cost provider, and so on.

If a subscriber wants to conduct a call over a provider that is not first in the LCR (because this provider is cheaper for long-distance calls, for example), he or she can select this provider via a specific trunk code or trunk key.

Subscribers can likewise also use selective dialing via seizure codes to reach a number that can only be dialed using ISDN (in cases where Vodafone is otherwise preset as the provider, for example).

By default, the seizure code 88 is configured for the seizure of an outside line via ISDN. All codes can be configured later by the administrator or edited as required.

### 15.2.7.1 How to Configure the Code for the Selective Seizure of ISDN Trunks

#### *Prerequisites*

- You are logged into the WBM with the **Expert** profile.

#### *Step by Step*

- 1) In the navigation bar, click on **Expert Mode**.
- 2) In the navigation tree, click **Telephony > LCR**.
- 3) Click on **Dial Plan**. The individual dial plans are listed.
- 4) Enter the desired name for the dial plan under **Name**.
- 5) Under **Dialed digits**, enter the seizure code and identifiers precisely (e.g., **88CZ**).

---

**INFO:** 88 is the default seizure code assigned by the system for the selective outside line seizure of an ISDN trunk.

For information about the abbreviations C and Z, see [LCR Dial Plan](#).

---

- 6) Under **Routing table**, enter a **1**.
- 7) Click on **Apply**, followed by **OK**.

### 15.2.7.2 How to Display the Seizure Code for the 'Outside Line Seizure'

The **CO Trunk ISDN / Analog / ITSP** wizard can be used to selectively display the codes for ISDN trunk seizure.

#### **Prerequisites**

- You are logged on to the WBM with the **Advanced** profile.
- Your communication system is connected to an analog trunk.

#### **Step by Step**

- 1) In the navigation bar, click on **Setup**.
- 2) In the navigation tree, click **Wizards > Central Telephony**.
- 3) Click on **Edit** to start the **CO Trunk ISDN / Analog / ITSP** wizard.
- 4) Continue clicking on **OK & Next** as often as needed until you reach the **Seizure Code for the 'Outside Line Seizure'** window.
- 5) In the default view, you will see the code for the ISDN trunk seizure. For configured ITSPs, the corresponding codes are shown.
- 6) Click on **OK & Next** followed by **Finish**.

## 15.3 Digit Analysis and Call Routing

This section illustrates the relationship between digit analysis and call routing. It explains how the communication system analyzes call numbers dialed by subscribers, trunks and applications of various types to reach a specific destination and how the calls are routed upon completion of the digit analysis. The relevant system functions for this have already been described for the most part in the previous sections. This section describes dialing with public phone numbers within a node/network in detail.

#### **The Digit Analysis**

- of the communication system records and evaluates all dialed numbers on the basis of the configuration data



- verifies classes of services (e.g., based on classes of service for stations, station flags, day/night, allowed and denied station numbers, LCR classes of service, schedules, connection matrices, etc.).
- determines whether a number can be dialed internally or whether a line is to be seized. This applies to the dialing of internal and public call numbers as well as for network-internal call numbers.
- normalizes call numbers so that they can be dialed by the communication system. (e.g., canonical format: "+49nnn" becomes "00049nnn", where the first '0' is the main access code of the PBX)
- truncates call numbers where necessary (the leading digits of destination numbers may have to be truncated for calls with inbound trunk seizure in order to determine the DID destinations in the short format)

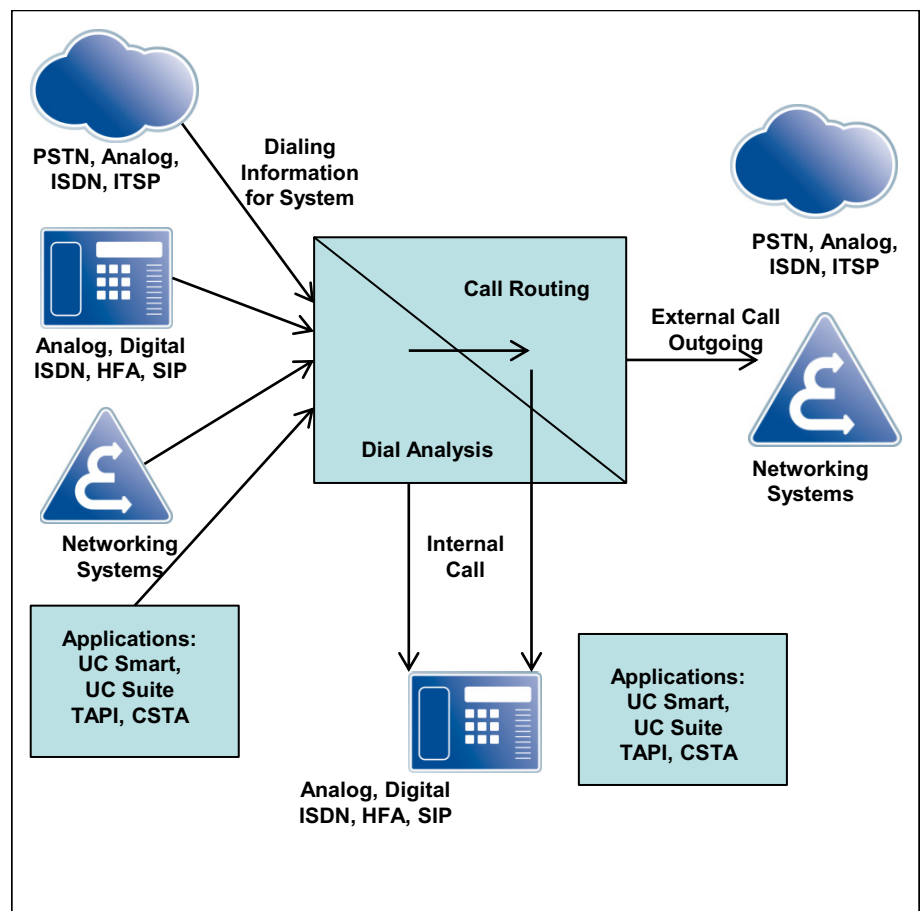

### 15.3.1 Overview of Call Routing / LCR

An incoming call is subjected to various tests in the communication system and then forwarded accordingly.

Test 1 (internal call destination?)

- Destinations with canonical call numbers are first converted into dialable numbers (at the station interface) or set to TON=International (ITSP interface).
- For trunk destination numbers, the call number portion of the PABX number of the corresponding route is stripped off if required.
- Internal calls are analyzed on the basis of the internal dial plan; for external calls, the dial plan for DID numbers is used.

Test 2 (internal call destination?)

- Subscribers, applications, clients or other communication systems use the public format (for example, 00049nnn) for dialing destination numbers
- Precondition: the default CO access code (e.g., "0") has been set up.
- The destination number is stripped to remove the location number (gateway location) portions and evaluated based on the dial plan of the DID numbers, regardless of whether an internal or external call is involved.
- If no internal call destination is found, the dialable, unstripped (!) call number is processed in the LCR, and the call is routed further over a line accordingly.

Within an IP network, the LCR routing table parameter "Dedicated Gateway" enables the direct addressing of a node for a dialed number by bypassing the CAR digit analysis.

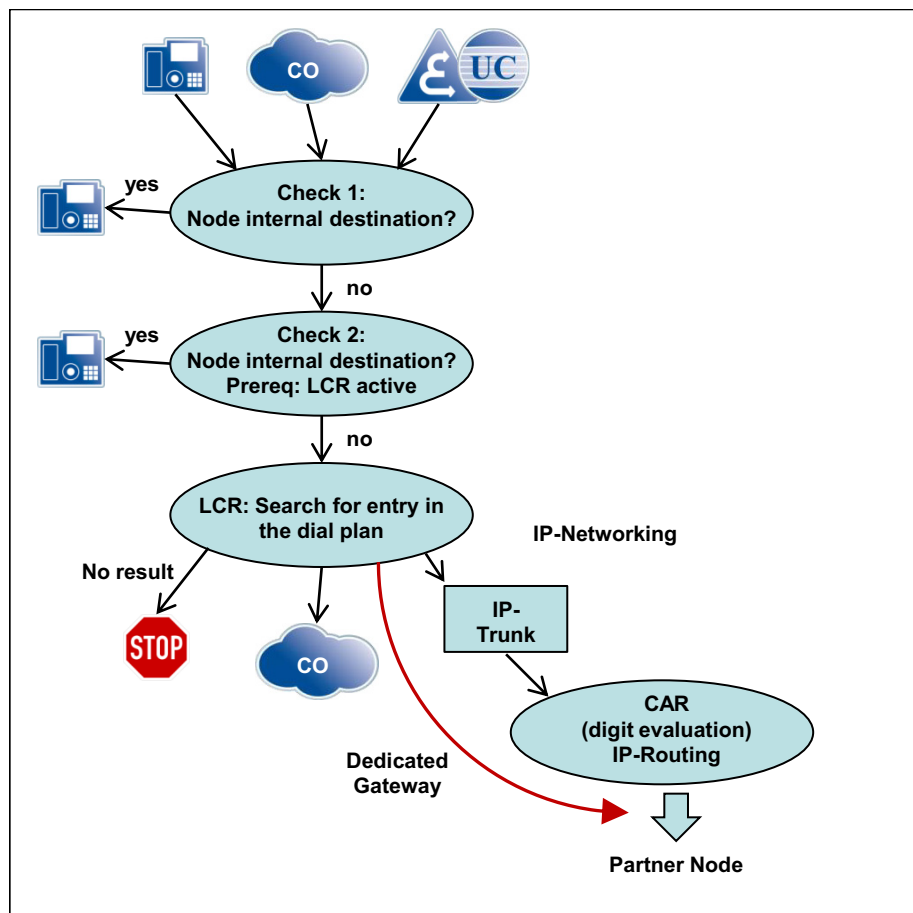

### 15.3.2 Digit Analysis Flowchart

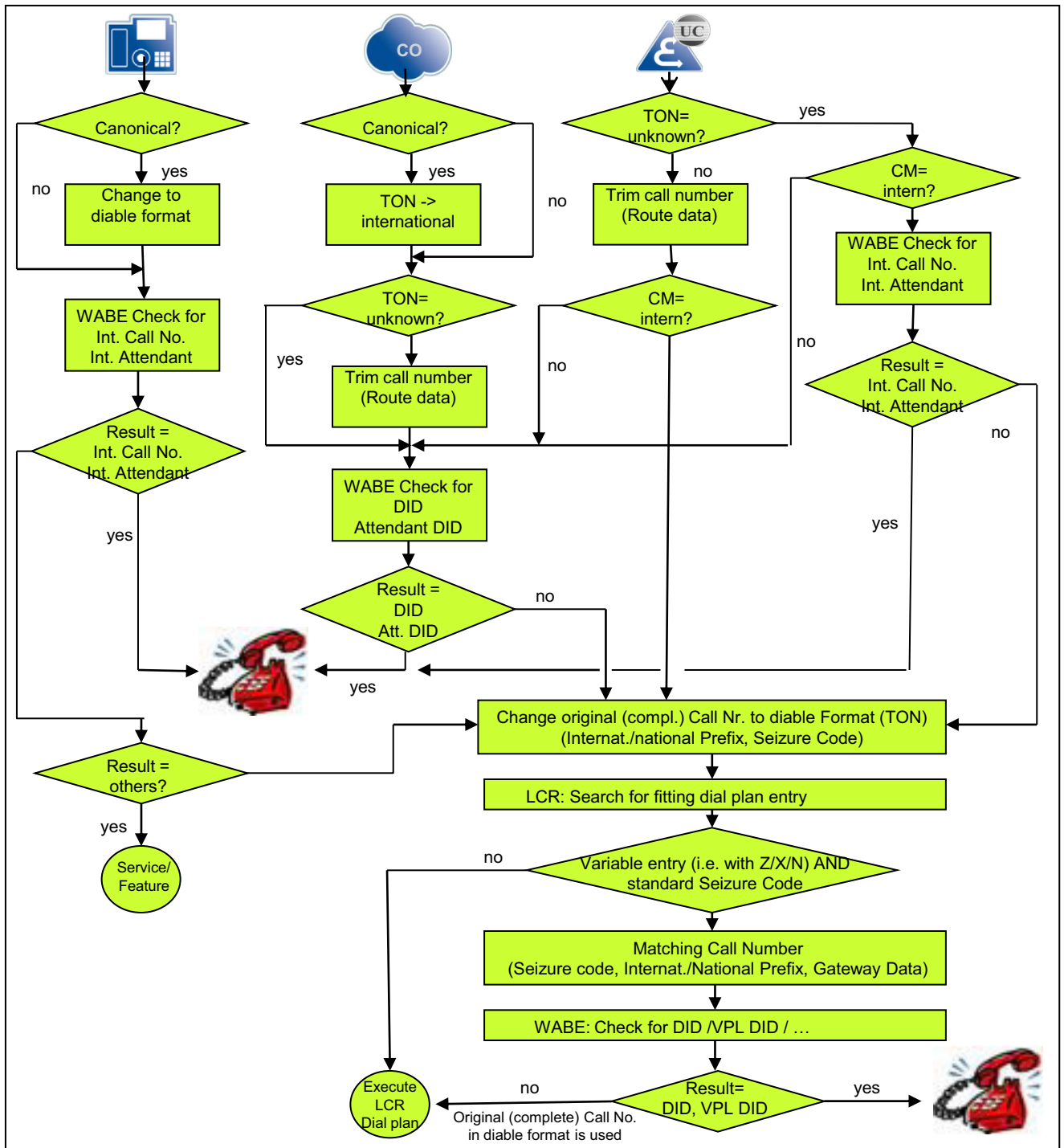

Explanations for the flowchart:

German	English	Explanation
WABE		Digit analysis
CM	CM	Classmark identifies the caller as an external caller or (network-) internal caller
TON	TON	Type Of Number (Call number type): Unknown, Subscriber, National or International; used for both destination numbers as well as originating numbers.
DuWa	DID	DID number
TNR RNR	Int. Call No.	Internal number
Int. Attendant	VPL INT	Attendant number for internal calls
VPL DID	VPL DID	Attendant number for external calls
SERVICE	SERVICE	Service code
LCR	LCR	Least Cost Routing

For digit analysis, UC clients are treated as subscribers controlled via CSTA.

For digit analysis, the UC Suite behaves as a SIP-Q trunk.

### 15.3.3 Call Routing and LCR in the Internetwork

Call routing and LCR play an important role in networking. Calls are routed by using a dial plan and dial rules. The dedicated gateway plays a special role here.

## LCR Basics

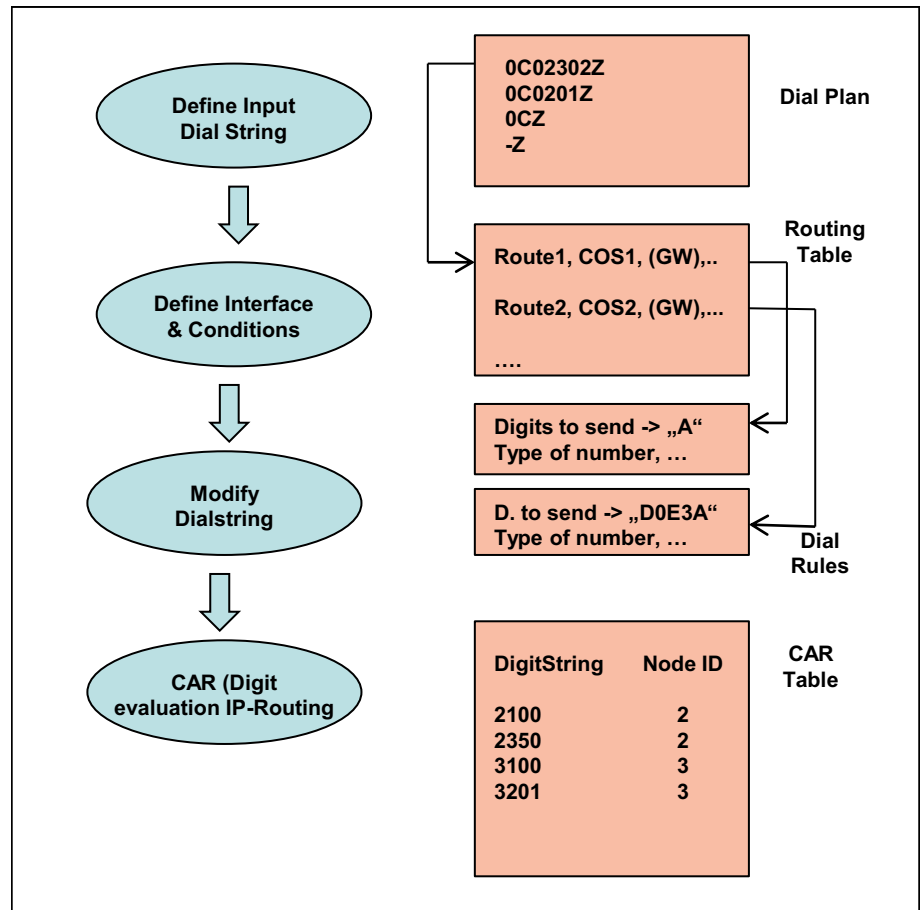

If no line seizure is successful, the entries in the routing table are processed sequentially in a loop.

---

**INFO:** -z rule must be removed from stand-alone system configuration.

---

## LCR Entries During the Initial Setup

When the communication system is started up for the first time, a number of country-specific default values are entered in the LCR dial plan. Up to and including dial plan 35, system-side entries for emergency calls, directory assistance, special numbers, default trunk seizure for PSTN and ITSPs, for UC Suite and networking, and for international dialing formats are preset to ISDN trunks.

This range can be affected by configuration changes elsewhere (for example, by changes to the **Location number** flag). Consequently, whenever the location number is changed, it must be ensured that the default trunk seizure still works as expected (which is important when dialing public numbers).

---

**INFO:** From LCR dial plan 36 onwards, all entries are freely available.

---

### 15.3.3.1 Dedicated Gateway

The dedicated gateway is only relevant for an IP network.

#### Why is a dedicated gateway required?

- The CAR table of each communication system includes network-wide numbers of the other nodes and is automatically refreshed (overwritten) cyclically during updates. Consequently, CAR tables are not suitable for the permanent use of manually added entries.
- Only numbers that apply network-wide are entered, i.e., no node-specific routing is possible (e.g., "0" to the respective gateway node)

#### How can destinations be permanently set up through configuration?

- By using direct addressing in the LCR
- The dedicated gateway directly addresses the destination node using the node ID (IP address)
- When using the dedicated gateway, CAR tables are bypassed (see previous figure).

#### Use cases for a dedicated gateway

Direct addressing

- of TDM gateways to seize outside lines ("0CZ")
- of TDM gateways to implement breakouts via separate codes
- of internal network nodes that are to be reached via public numbers
- of TDM gateways to which the subscribers of a multi-gateway network (to an OpenScape Business S) are assigned (e.g., subscriber 1 belongs by definition to gateway 1, and subscriber 2 belongs to gateway 2).
- of gateways and calls whose origin CANNOT be associated with a specific gateway in a mult-gateway configuration (e.g., the fax group of a UC Contact Center)

### The Dedicated Gateway in the WBM

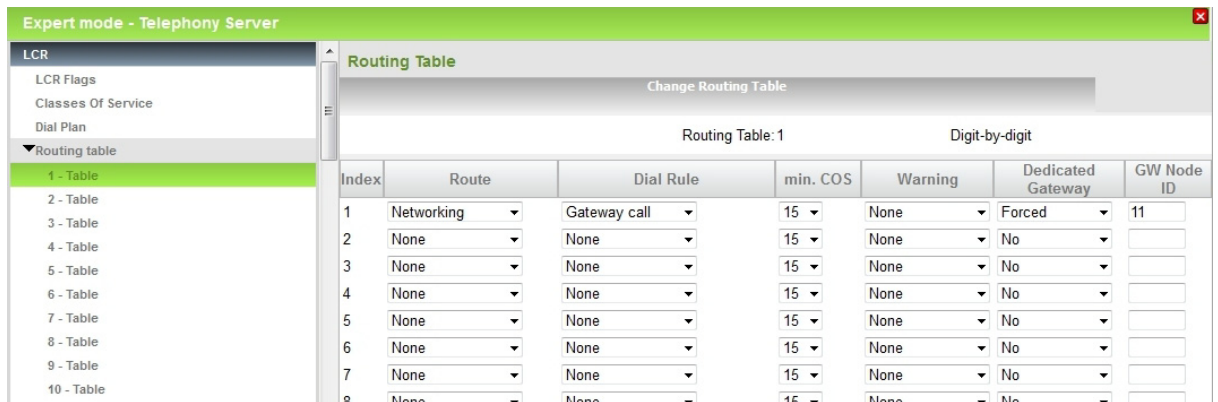

The following values can be set:

<b>No</b>	The station number analysis occurs on the basis of the CAR tables (no <b>GW node ID</b> required)
<b>Forced</b>	Routed directly to the appropriate gateway (GW node ID = n)
<b>Multi Location</b>	Only to be used with multi-gateway configurations: Based on the multi-gateway configuration of the OpenScope Business S subscribers, the communication system knows the assignment to their respective gateways and can selectively route outbound calls to the appropriate gateway. In the <b>Multi Location</b> configuration, the GW node ID is used only if no gateway can be identified through the assignment of the subscriber (default).

## 15.3.4 Scenarios: Digit Analysis and Call Routing

In order to illustrate the above processes in the communication system, the dependencies and required configuration parameters are described here on the basis of specific scenarios. The presented scenarios may build on one another, depending on the use cases involved.

### Single System

1. Subscriber A calls subscriber B via an internal phone number
2. Subscriber A calls subscriber B via a public phone number
3. Subscriber A calls an external station via the CO
4. ISDN trunk calls subscriber A
5. Special configurations and their corresponding effects  
2 CO routes

### Networked system as a subsystem (no CO trunk)

1. Subscriber A Calls Subscriber C via an Internal Phone Number
2. Subscriber A calls subscriber C via a public number in the internetwork

## Call Routing

### Digit Analysis and Call Routing

3. ISDN trunk calls subscriber C

#### Inter-network with multi-gateway

1. ISDN trunk gateway 1 calls subscriber D
2. Subscriber D calls external station via the CO

#### 15.3.4.1 Subscriber A Calls Subscriber B via an Internal Phone Number

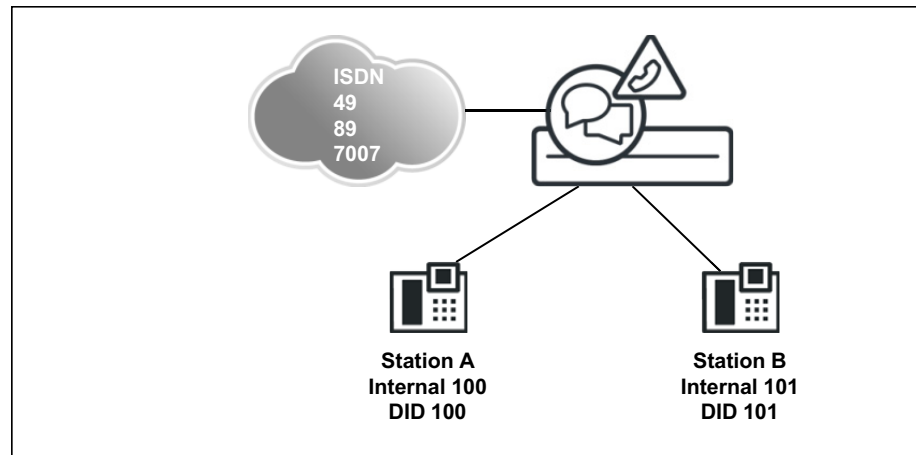



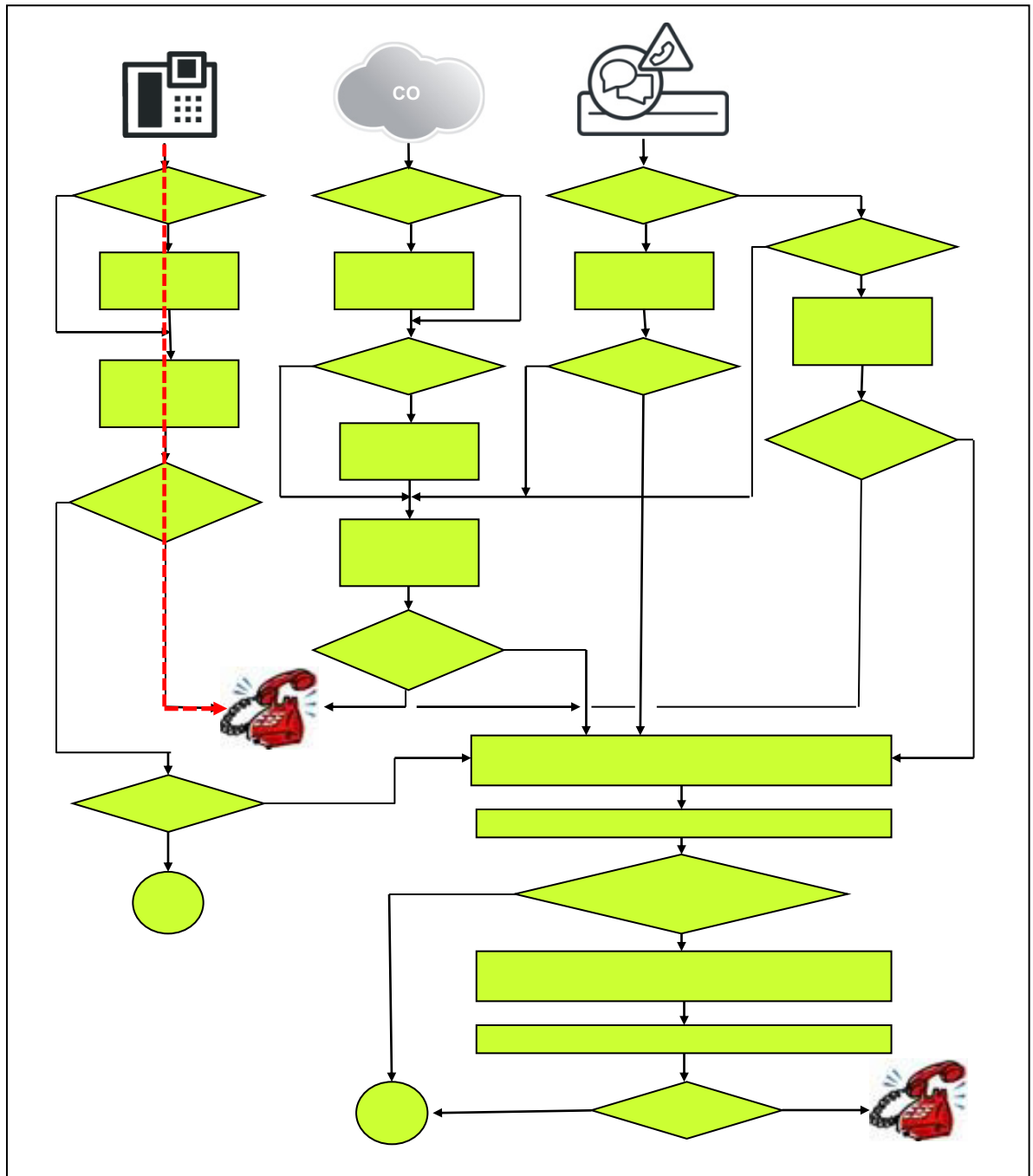

Configuration of the two internal phone numbers

	Box	Slot	Callno	Name	DID	Type
	1	1	100	-	100	System Client
	1	1	101	-	101	System Client

### 15.3.4.2 Subscriber A calls subscriber B via a public phone number

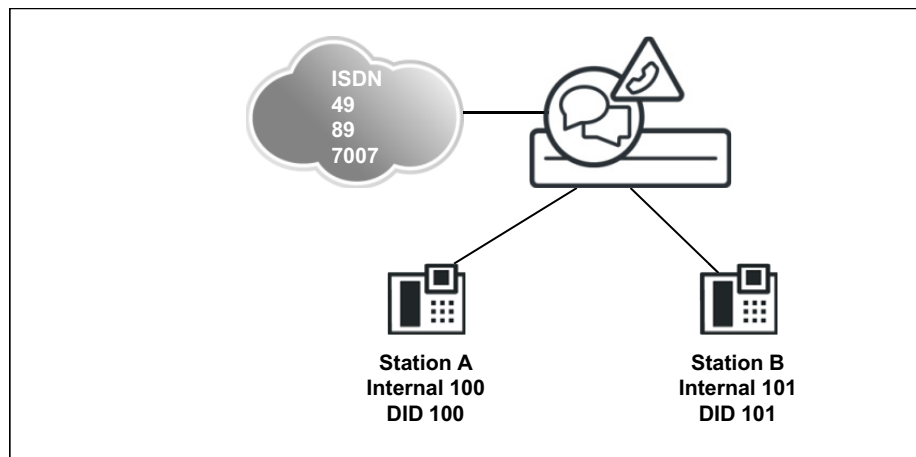

The call is delivered internally in the system, since the destination number is a DID station of the own system.

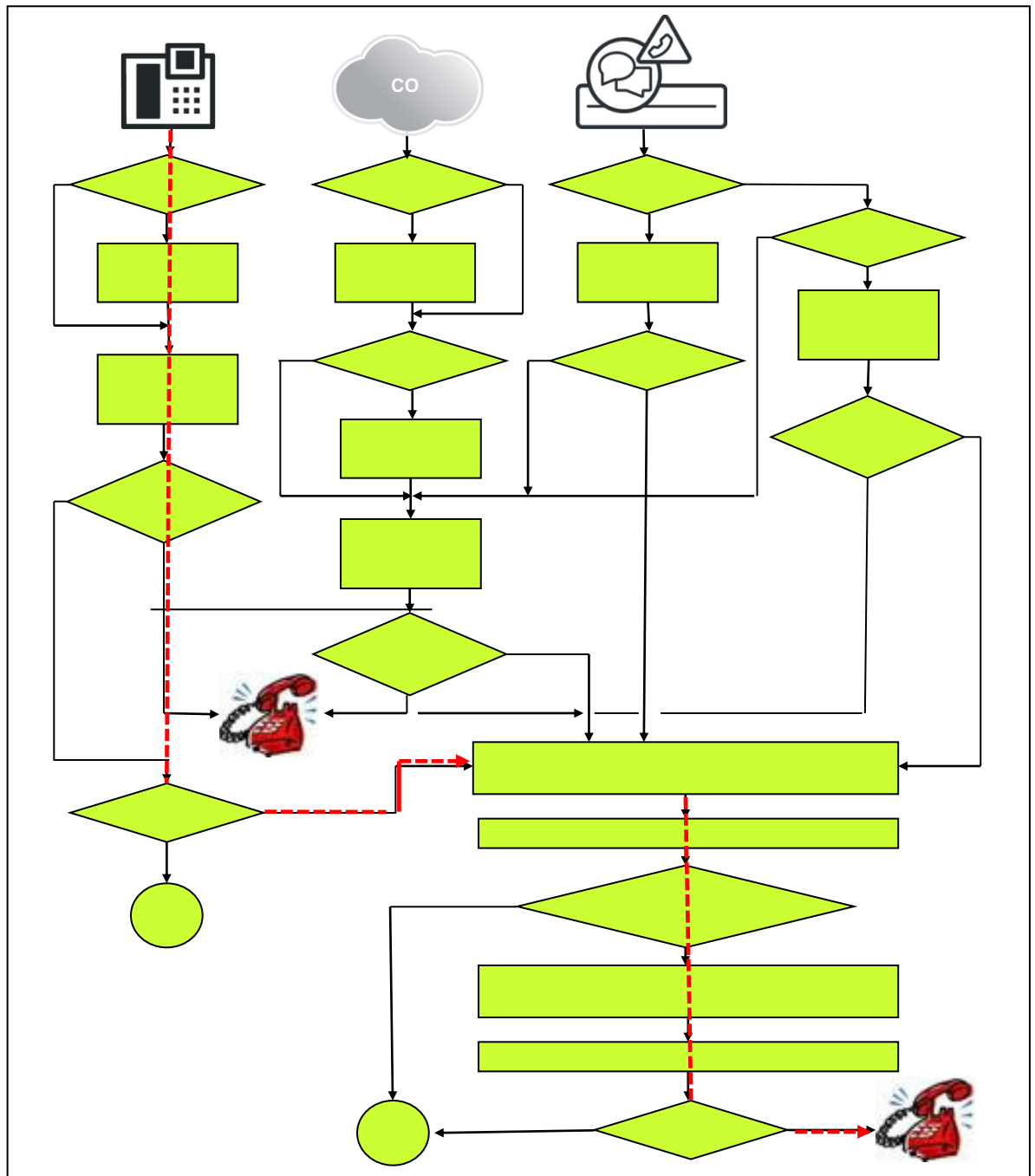

**Configuration**

	Box	Slot	Callno	Name	DID	Type
	1	1	100	-	100	System Client
	1	1	101	-	101	System Client

Once the destination number has been stripped using the gateway location, the stripped call number is used to search for a destination in the DID dial plan.

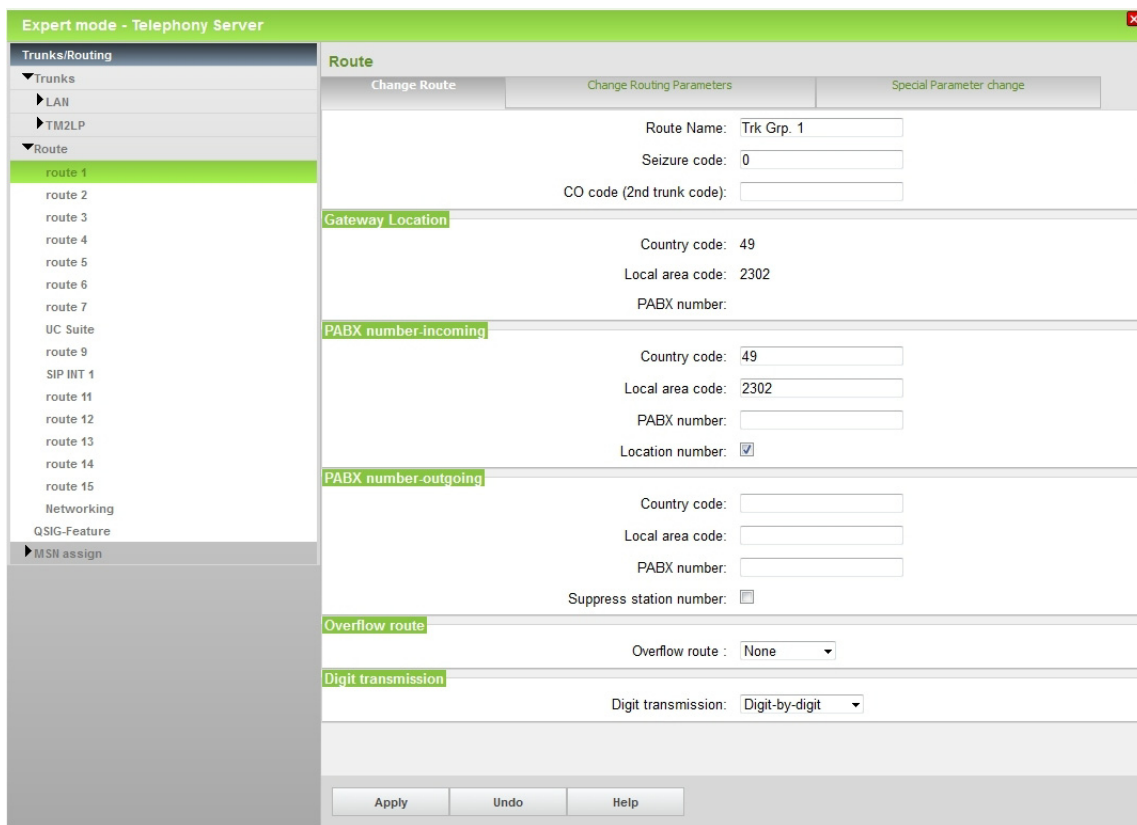

### Dependencies of the "Location Number" (Gateway Location)

The location number (gateway location) is analyzed on dialing based on the public phone number. If the relevant portions of the dialed number matches this number, the DID table is analyzed and, if a match is found, the appropriate internal destination is dialed (without seizing a trunk!). By setting the Location Number flag, the location data is taken over automatically from the appropriate routing data (PABX number, incoming) and does not need to be changed in standard scenarios.

Consequently, only valid numbers assigned to this system should be entered in the DID tables; otherwise, masking effects could occur with numbers in the public network. For example, in some cases, an internal number identified by an invalid DID could be called even though a call via a trunk to an external destination was intended.

Changes to the "Location Number" flag may affect the preset default LCR entries. Whenever the location number is changed, it must be ensured that the default trunk seizure still works as expected. This is important when dialing public numbers.

### 15.3.4.3 Subscriber A calls an external station via the CO

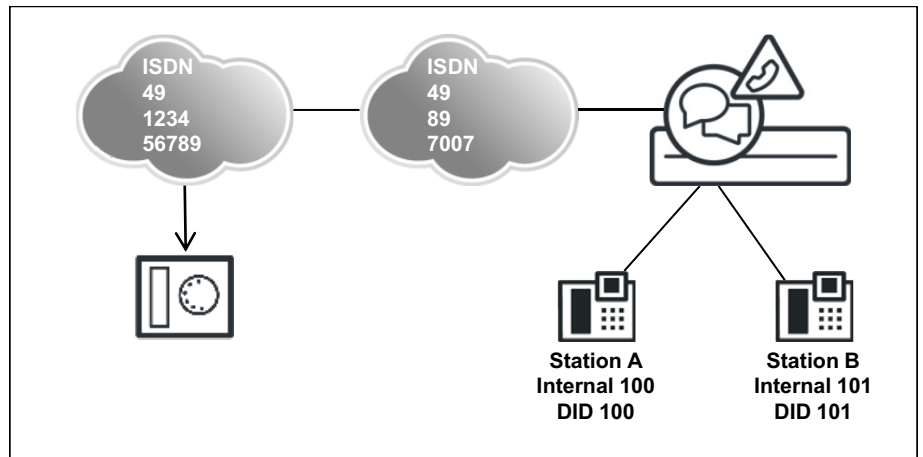

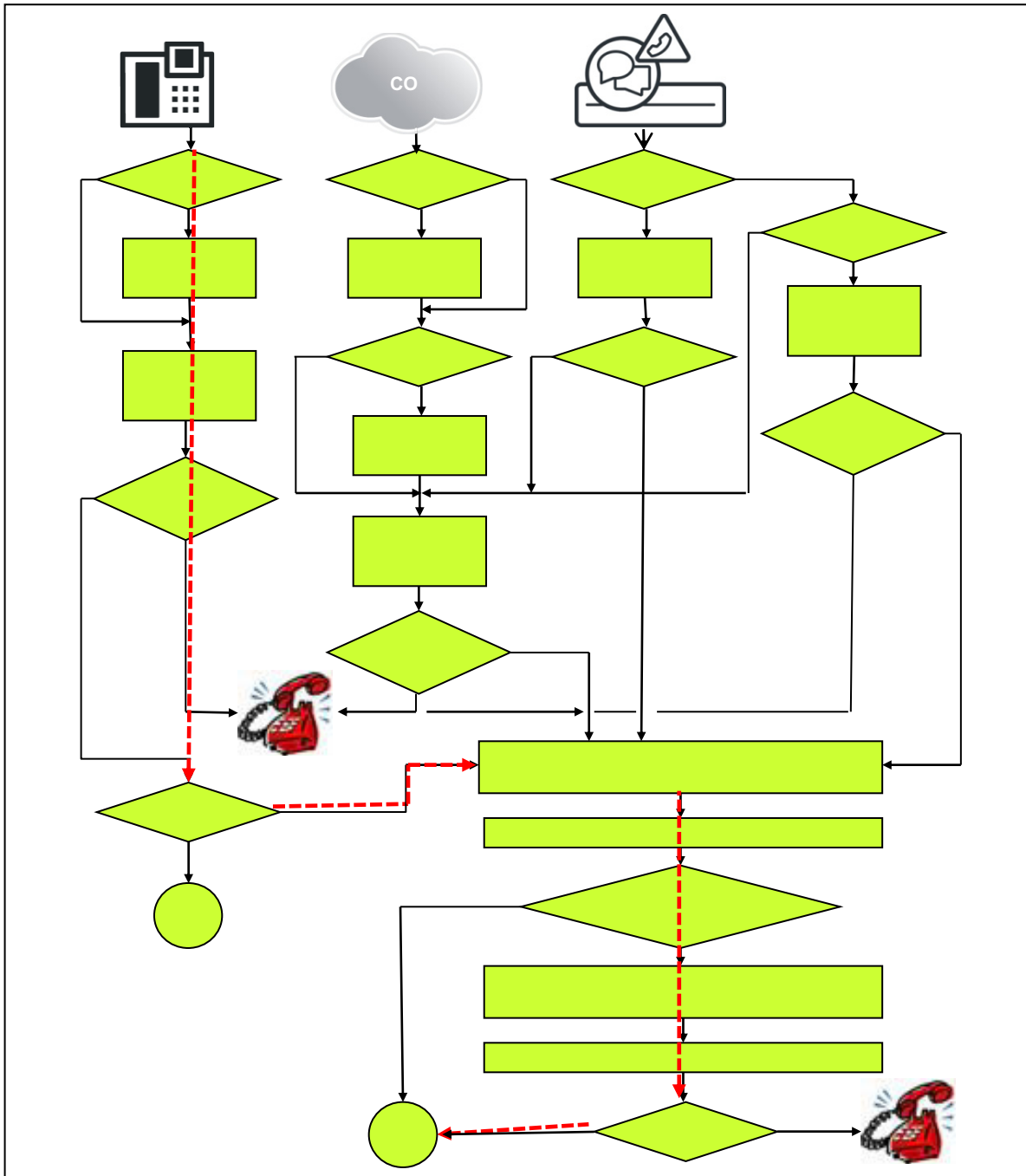

The call is routed via LCR because the destination is not in the own communication system.

In addition to the data of the previous scenario "Subscriber A calls subscriber B via a public phone number", a suitable dial plan entry to seize the CO trunk (e.g., "OCZ") must be present in the LCR.

The LCR route table and the dial plan must be set up accordingly.

Expert mode - Telephony Server

LCR  
LCR Flags  
Classes Of Service  
Dial Plan  
Routing table  
Dial rule

Dial Plan

Change Dial Plan      Display Dial Plan

Dial Plan	Name	Dialed digits	Routing Table	Acc. code	Classes of service	Emergency
16	Standard	0CZ	1		<input checked="" type="checkbox"/>	<input type="checkbox"/>
17	Standard	0C1Z	1		<input checked="" type="checkbox"/>	<input type="checkbox"/>
18	Standard	0CNZ	1		<input checked="" type="checkbox"/>	<input type="checkbox"/>
19	Standard	855CZ	4		<input checked="" type="checkbox"/>	<input type="checkbox"/>
20	Standard	855C1Z	5		<input checked="" type="checkbox"/>	<input type="checkbox"/>
21	Standard	855CNZ	5		<input checked="" type="checkbox"/>	<input type="checkbox"/>
22	Standard	856CZ	6		<input checked="" type="checkbox"/>	<input type="checkbox"/>
23	Standard	856C1Z	7		<input checked="" type="checkbox"/>	<input type="checkbox"/>
24	Standard	856CNZ	7		<input checked="" type="checkbox"/>	<input type="checkbox"/>
25	Standard	857CZ	8		<input checked="" type="checkbox"/>	<input type="checkbox"/>
26	Standard	857C1Z	9		<input checked="" type="checkbox"/>	<input type="checkbox"/>
27	Standard	857CNZ	9		<input checked="" type="checkbox"/>	<input type="checkbox"/>
28	Standard	858CZ	10		<input checked="" type="checkbox"/>	<input type="checkbox"/>
29	Standard	858C1Z	11		<input checked="" type="checkbox"/>	<input type="checkbox"/>
30	Standard	858CNZ	11		<input checked="" type="checkbox"/>	<input type="checkbox"/>
31	Appl-Suite	-8555	12		<input checked="" type="checkbox"/>	<input type="checkbox"/>
32	Standard	88CZ	1		<input checked="" type="checkbox"/>	<input type="checkbox"/>
33	IP-Network	-Z	13		<input type="checkbox"/>	<input type="checkbox"/>
34	COInternat	0C0049-Z	14		<input checked="" type="checkbox"/>	<input type="checkbox"/>
35	Ann-Player		12		<input checked="" type="checkbox"/>	<input type="checkbox"/>
36			-		<input checked="" type="checkbox"/>	<input type="checkbox"/>
37			-		<input checked="" type="checkbox"/>	<input type="checkbox"/>
38			-		<input checked="" type="checkbox"/>	<input type="checkbox"/>
39			-		<input checked="" type="checkbox"/>	<input type="checkbox"/>
40			-		<input checked="" type="checkbox"/>	<input type="checkbox"/>
41			-		<input checked="" type="checkbox"/>	<input type="checkbox"/>

Page 1 of 20      Items per page 10 25 50 100

Apply    Undo    Help

### 15.3.4.4 ISDN trunk calls subscriber A

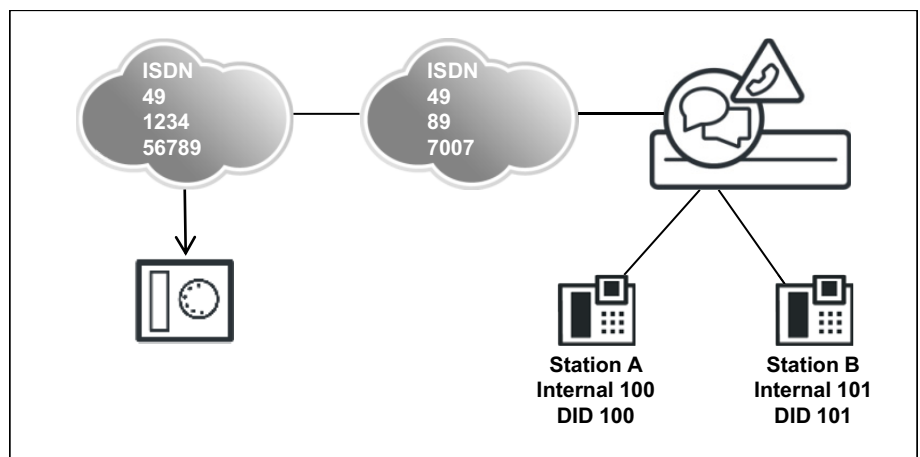

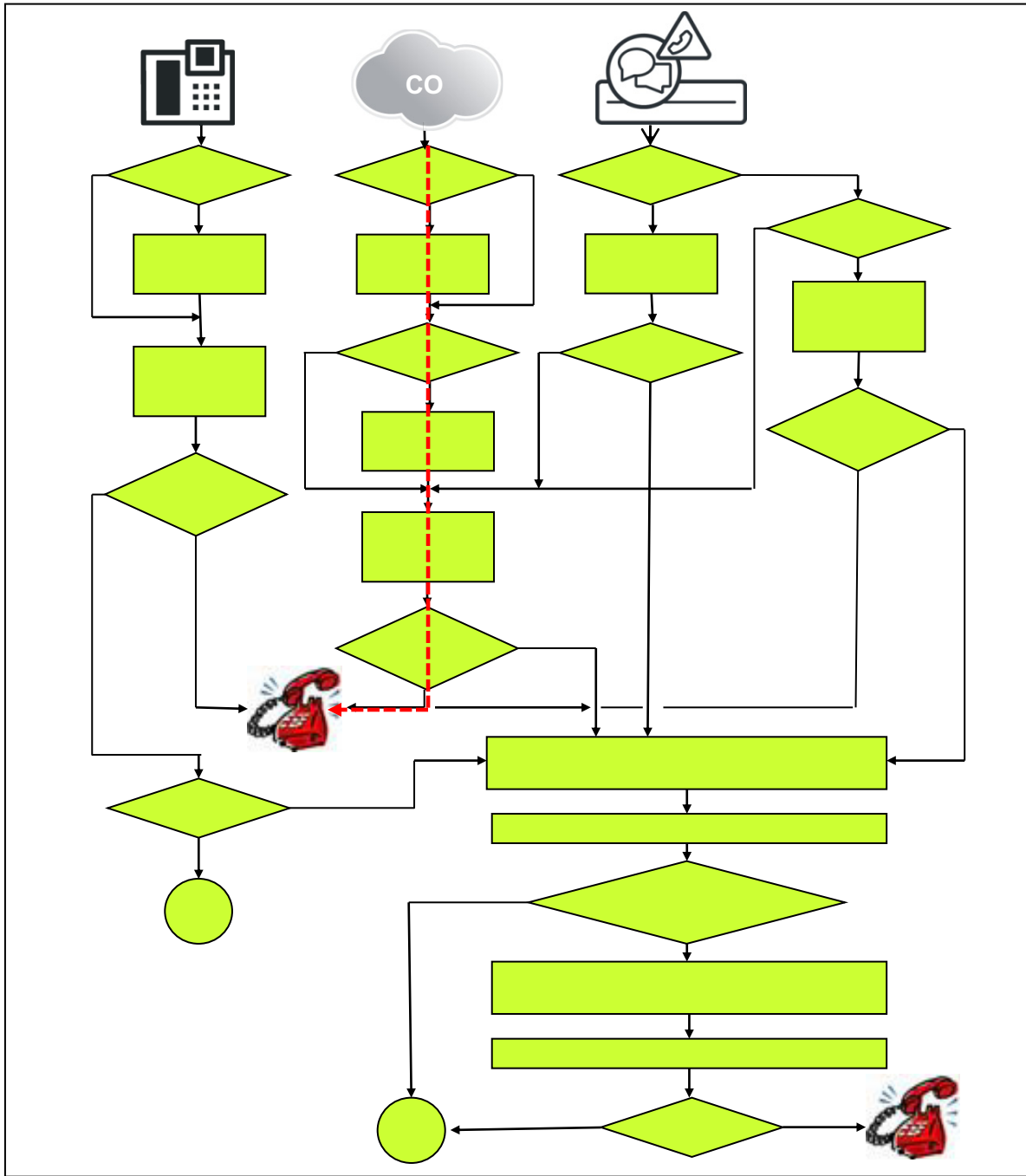

For an incoming call over an ISDN trunk, the route is stripped off from the destination number based on the configuration data of the PABX number, incoming. Using the remainder of the destination number (DID), a search for a destination is then performed in the DID dial plan.

The parameters of the gateway location and the **Location Number** flag play no role in this scenario.



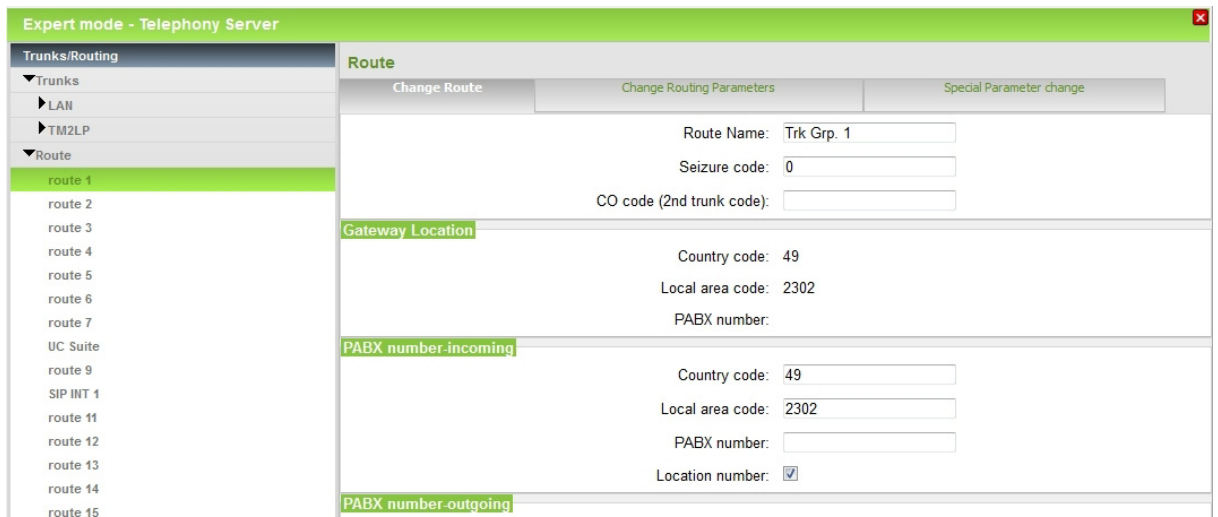

### 15.3.4.5 Special Configurations

Special configurations and their corresponding effects: 2 CO routes

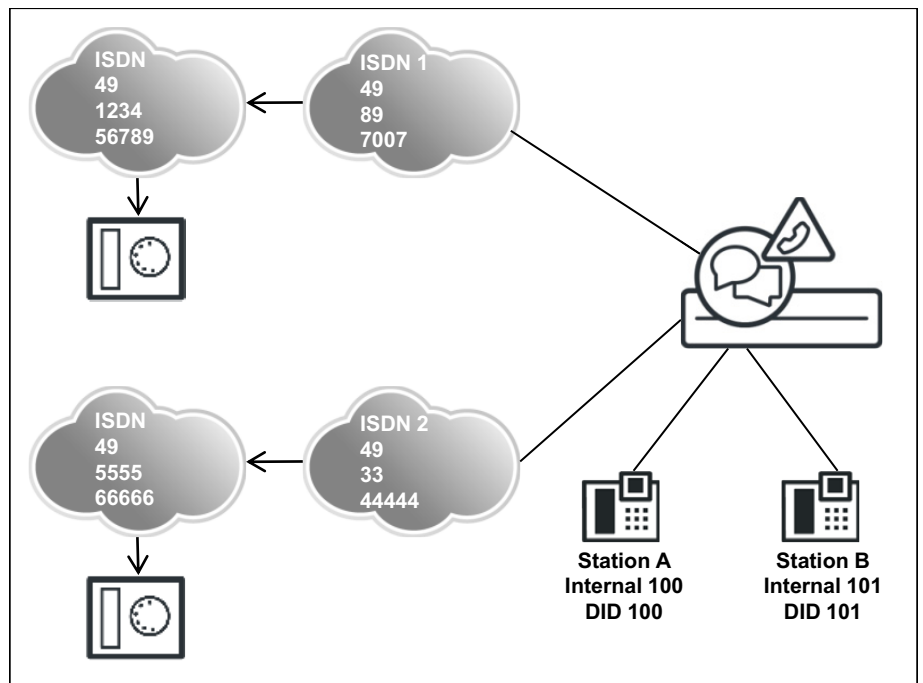

Subscriber A calls external subscriber via the CO trunk 1 or 2

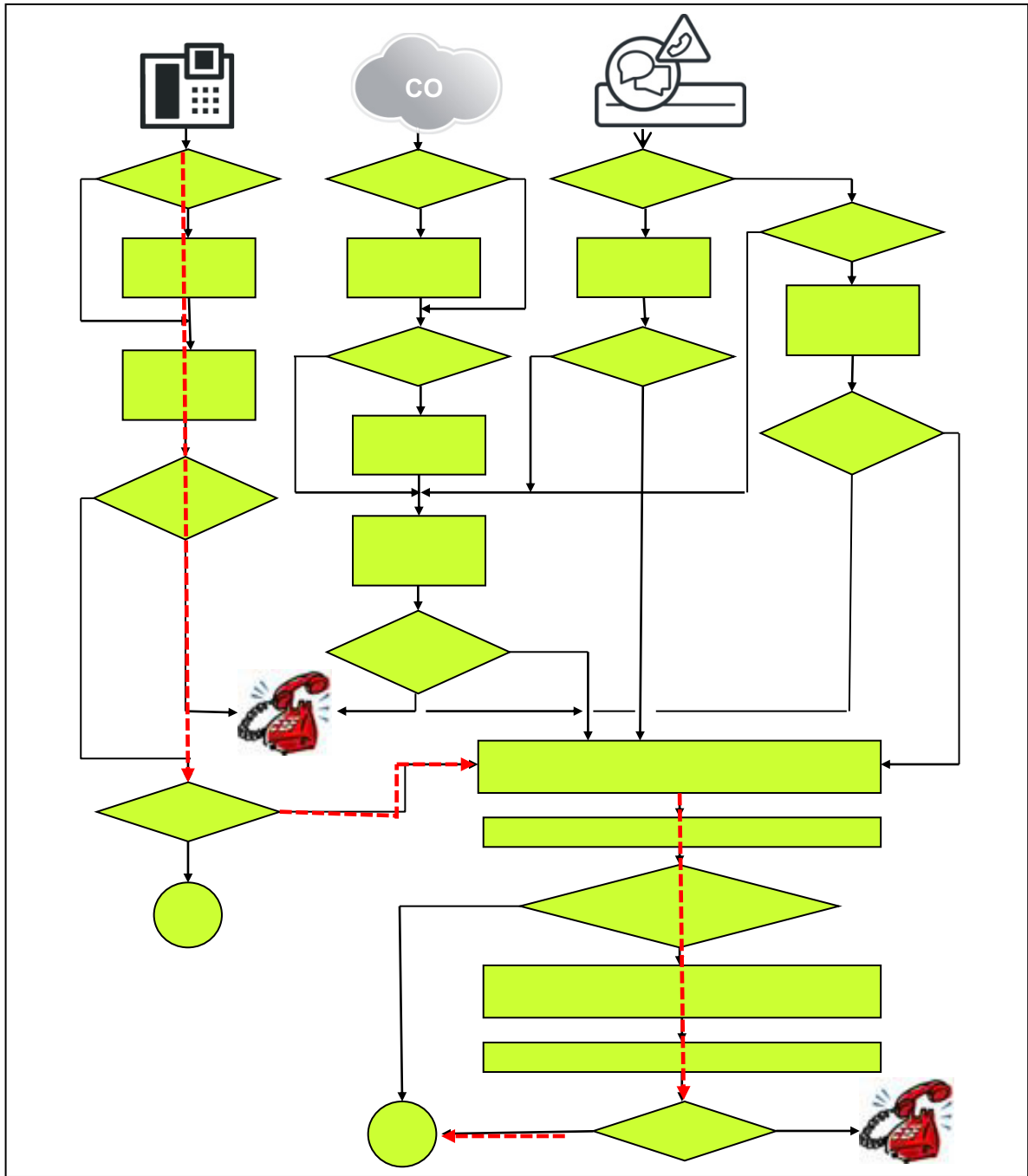

Example:

- A customer wants to use a standard ISDN 1 connection. This is set up as the location number.
- A second ISDN 2 connection is additionally used for special applications.

Notes and limitations:

- Only ONE CO trunk (ISDN 1 = location of the system) is fully supported, i.e., no multi-tenant configuration (tenant services) with equal trunk access rights can be configured.
- The additive ISDN 2 CO trunk can be used for Basic Call (incoming/outgoing).
- In complex switching scenarios, the correct representation of the call number may not be guaranteed under some circumstance.
- For connected applications, only the location number is supported, as is the case when dialing internal destinations with public numbers.
- The configuration with respect to the routing configuration and LCR can be derived from the previous examples.

### 15.3.4.6 Subscriber A Calls Subscriber C via an Internal Phone Number

Networked communication system as a subsystem (no CO trunk)

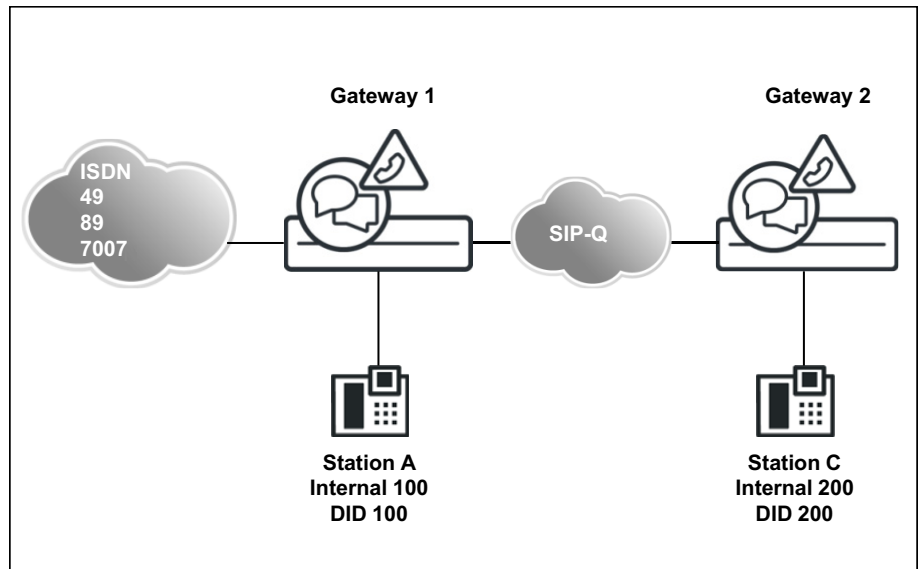

**Call Routing**  
Digit Analysis and Call Routing

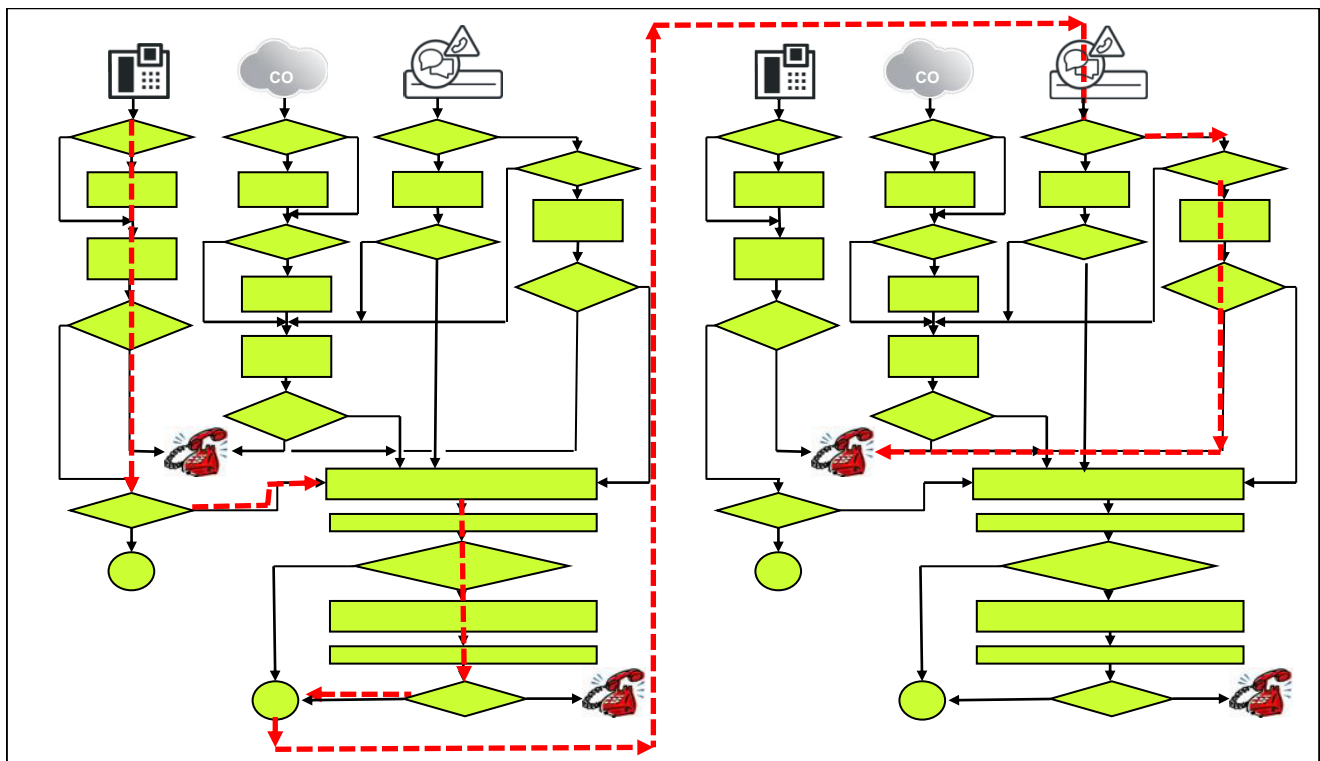

Prerequisites for standalone systems before networking:

- Both communication systems have unique IP addresses and are integrated in the IP network of the customer.
- Both communication systems can be administered in the customer network using WBM.
- A unique node ID for networking was assigned in the basic installation for each communication system (e.g., System 1 = Node ID 1 and System 2 = NID) 2).
- Defining the numbering in the basic installation of the systems 1 and 2: The numbering of the standalone systems must take the closed numbering in the future internetwork into account.
- This example assumes that closed numbering is being used (mandatory when using UC Suite!); the configuration occurs via the Network wizard. With open numbering (possible for UC Smart), the Network wizard is not used. It is also not used with a connection of OpenScape Voice and OpenScape 4000.

Overview

Note: At least the configuration of the 'Country code' is needed for features such as 'Internet telephony' and 'MeetMe conference'.  
If you want your OpenScape Business in " OpenScape Business Network Integration " you should select the "Network Integration" check box and enter a node ID. In this case, make sure that this node ID is unique within the whole network integration.  
Normally, this integration is done by a Service Technician.  
For a standalone OpenScape Business clear the 'Network Integration' check box.

**PABX number**

Country code: 49 (mandatory)  
Local area code: 89 (optional)  
PABX number: 7007 (optional)

**General**

International Prefix: 00

**Network Parameters**

Network Integration:   
Node ID: 1

Start the Network wizard in system 1. This system (this node) is declared as the master). The master has several central functions in the network (e.g., administration, license management with centralized licensing, network-wide CSP).

If an OpenScape Business S is located in the internetwork, it should be preferentially declared as the master (for bandwidth and performance reasons).

Node type

If a network is configured, one system, and only one, in the network must be a MASTER node.

This system is the MASTER node   
This system is a SLAVE node

The IP addresses are entered for each node so that the systems can find one another independently after the administration. The OpenScape Business systems are entered **Type**.

This dialog must also be completed for node 2 (slave).

Node input

Enter the IP addresses of the corresponding OpenScape Smart Office systems in the domain.  
The Application Server IP address can be the IP address of an application board or a connected OSBiz UC BS.

	Nodeid	OSBiz X / OSBiz S	Net Name	Type	Application Server	Encryption	Registration Status
	1	192.168.10.90	Master	OSBiz X	<input type="checkbox"/>	<input type="checkbox"/>	✓
Delete	2	192.168.10.91	Slave	OSBiz X	<input type="checkbox"/>	<input type="checkbox"/>	-

Upon successful configuration, the two systems (nodes) synchronize their phone numbers and enter the call numbers of the other node into the CAR table.

With the creation of the CAR tables, network-wide telephony with internal numbers is possible. UC Suite is also launched network-wide. Further steps for the complete startup of the network are presented in the other scenarios.

CAR entries are controlled via **Expert Mode > Voice Gateway > Networking > Routing**.

An overview of the automatic synchronization in the internetwork can be seen in the WBM (sync status).

Additional network nodes can now be administered with direct access under the menu item **Networking** in the navigation bar.

### 15.3.4.7 Subscriber A calls subscriber C via a public number in the internetwork

Networked communication system as a subsystem

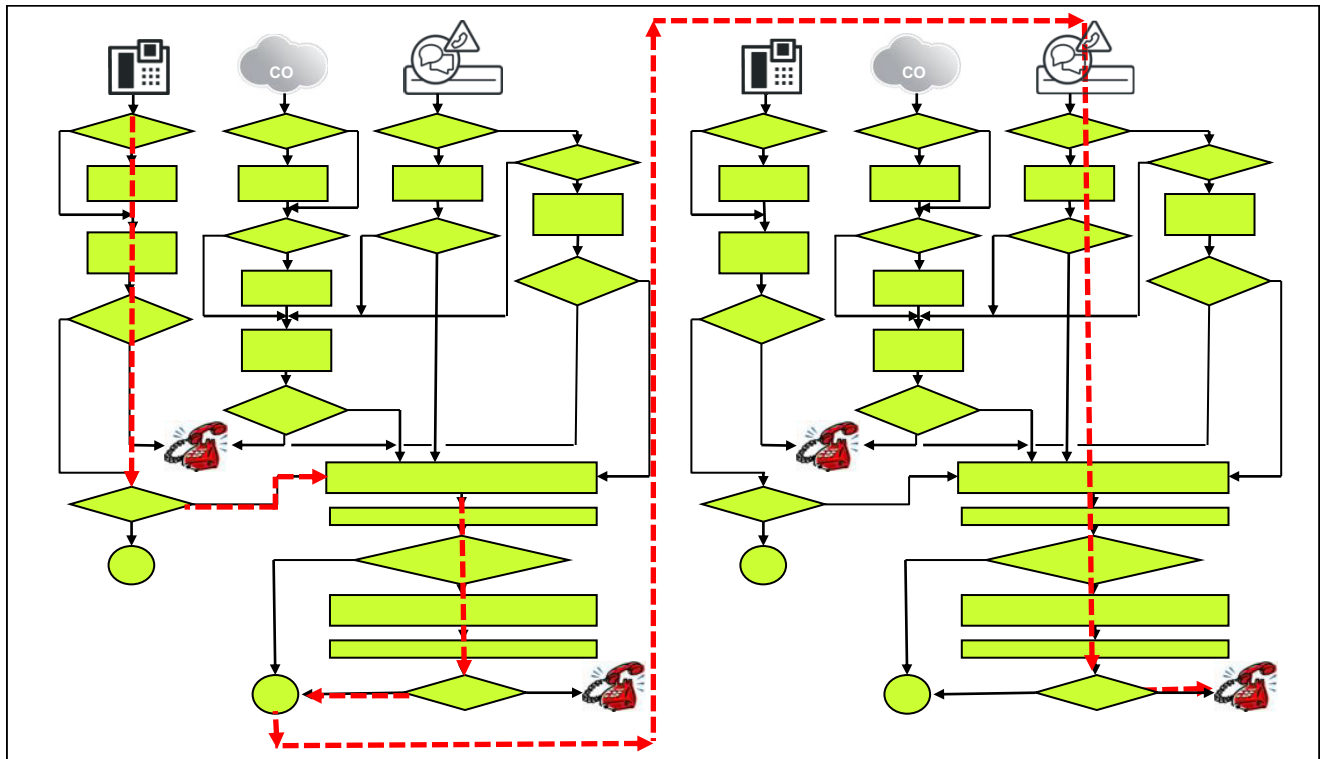
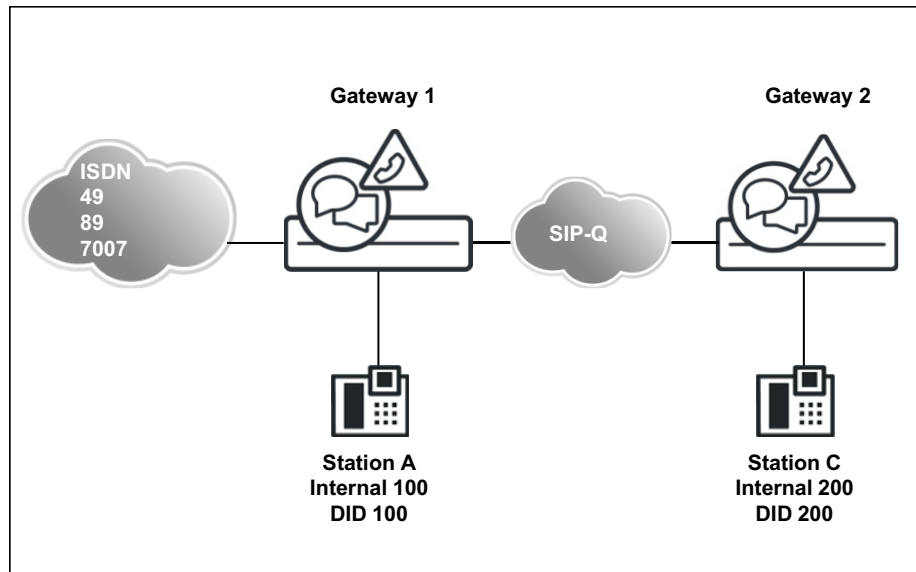

Special features of this scenario:

- System 1 detects that the destination phone number does not belong to the own system. A further search is thus performed in the LCR. The dedicated gateway in the LCR of system 1 must be used for the direct addressing of the node ID of system 2. The destination number is not an internal number of the network (it would otherwise be in the CAR table), but a public phone number, which can be dialed by the subscriber in three different lengths:  
 Long = 00049897007nnn  
 Medium = 00897007nnn  
 Short = 07007nnn  
 This example assumes that all 2xx DID numbers are subscribers in system 2.

**NOTICE:** The dial plan entries must be configured precisely so that ALL numbers involved really belong to the subnode (internetwork). This may require a larger number of entries in a dial plan with peculiarities, e.g., when a shared trunk connection or an MSN configuration is involved.

- In node 2, a location number is entered with the location data of node 1 (gateway) using a "dummy CO trunk" so that the destination number from the public dialing can be stripped before searching for an internal destination in node 2.

### Configuration of Node 1, Setup in the LCR via Dedicated Gateway

Dial Plan	Name	Dialed digits	Routing Table	Acc. code	Classes of service	Emergency
40	System 2 DialInt	0C0049897007-2XX	40 →	<input type="checkbox"/>	<input checked="" type="checkbox"/>	<input type="checkbox"/>
41	System 2 DialNat	0C0897007-2XX	40 →	<input type="checkbox"/>	<input checked="" type="checkbox"/>	<input type="checkbox"/>
42	System 2 DialSub	0C7007-2XX	40 →	<input type="checkbox"/>	<input checked="" type="checkbox"/>	<input type="checkbox"/>
43			- →	<input type="checkbox"/>	<input checked="" type="checkbox"/>	<input type="checkbox"/>
44			- →	<input type="checkbox"/>	<input checked="" type="checkbox"/>	<input type="checkbox"/>

Index	Route	Dial Rule	min. COS	Warning	Dedicated Gateway	GW Node ID
1	Networking	Dial Rule 40	15	None	Forced	2

Index	Rule Name	Dial rule format	Network access	Type
36			Unknown	Unknown
37			Unknown	Unknown
38			Unknown	Unknown
39			Unknown	Unknown
40	Dialrule 40	D49897007E3A	Corporate Network	Country code

### Configuration of Node 2, Setup of the "Networking" Route

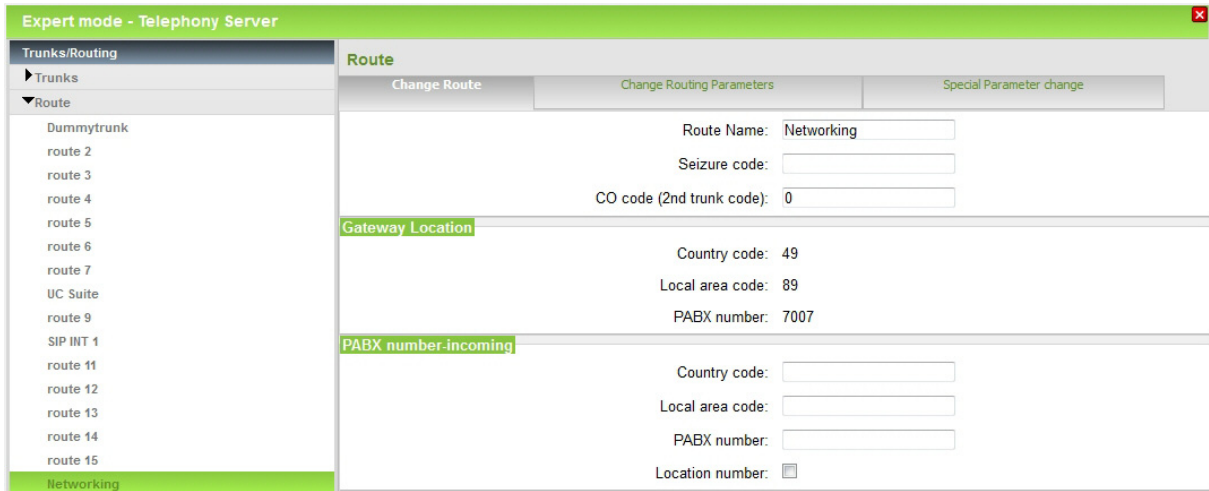

The route type **PABX** must be entered on the **Change Routing Parameters** tab.

### Configuration of Node 2, Setup of the Location Number at the "Dummy CO Trunk"

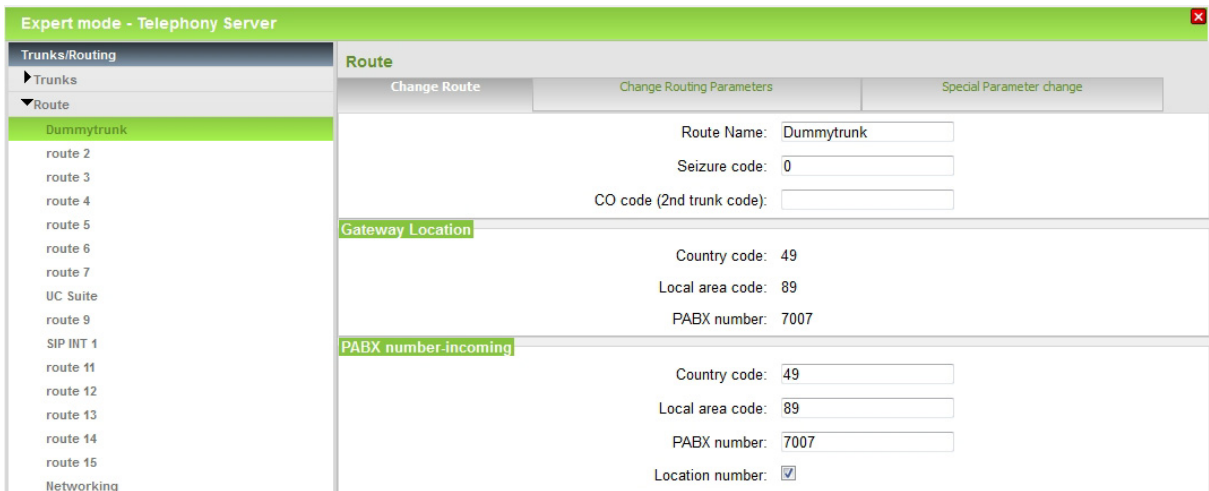

The route type **CO** must be entered on the **Change Routing Parameters** tab.

### Configuration of Node 2, Setup in the LCR via Dedicated Gateway

In node 2, all public numbers that do not belong to their own node are routed to node 1 (default dialing, e.g., 0CZ)

## 15.3.4.8 ISDN trunk calls subscriber C

Networked System as a Subsystem



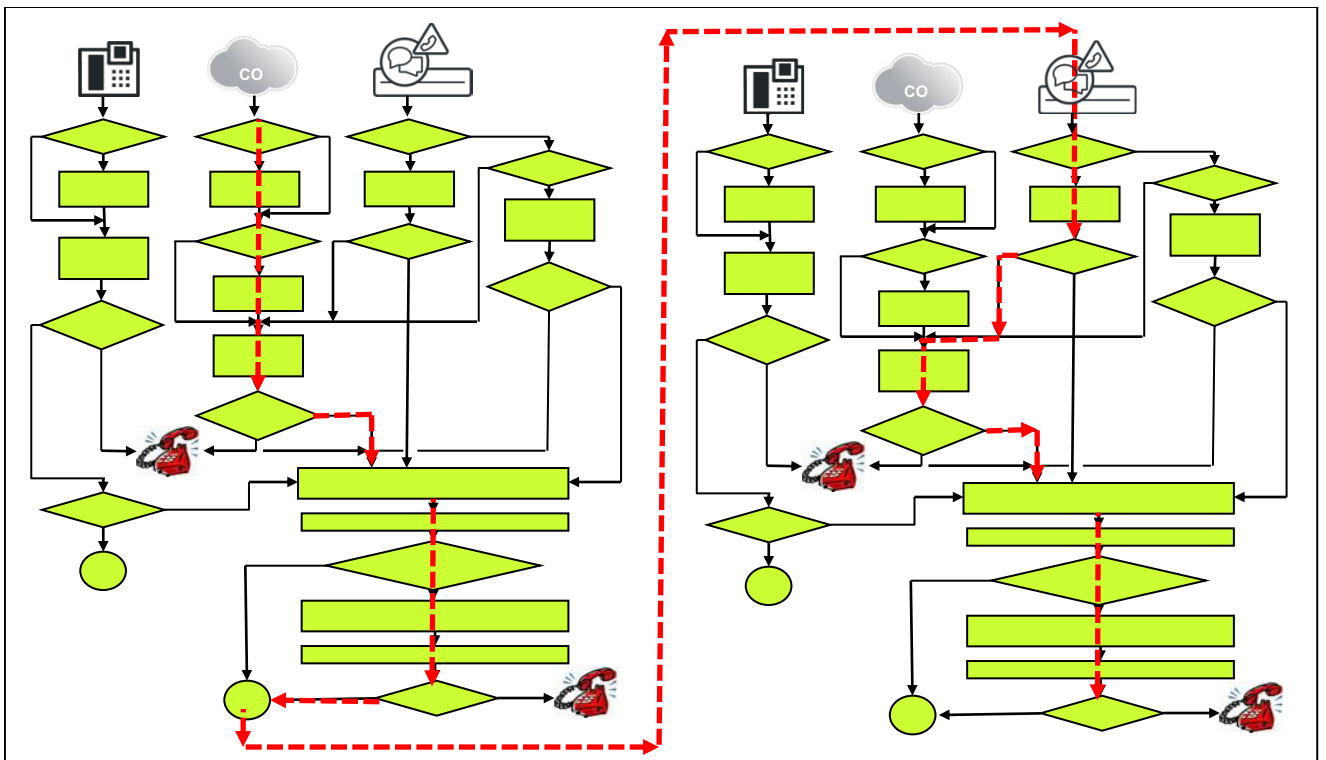
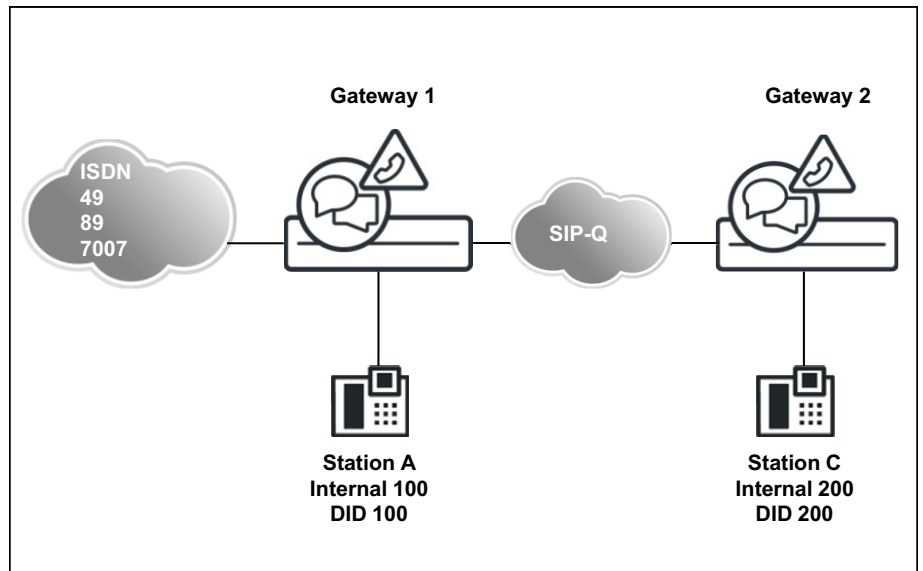

Example: Incoming call with destination number with TON = subscriber

**Special Features of this Configuration**

- Node 1 must be set up as described in the previous scenario. The addressing of node 2 occurs with the public telephone number in both cases, regardless of whether the origin of the connection is located in node 1 (subscriber of system 1) or in the public network.

---

**INFO:** The dial plan entries must be configured precisely so that ALL numbers involved really belong to the subnode (internetwork). This may require a larger number of entries in a dial plan with peculiarities, e.g., when a shared trunk connection or an MSN configuration is involved.

---

- Node 2 must likewise be set up as described in the previous scenario.

### 15.3.4.9 ISDN Trunk Gateway 1 Calls Subscriber D

Networked system in a multi-gateway configuration

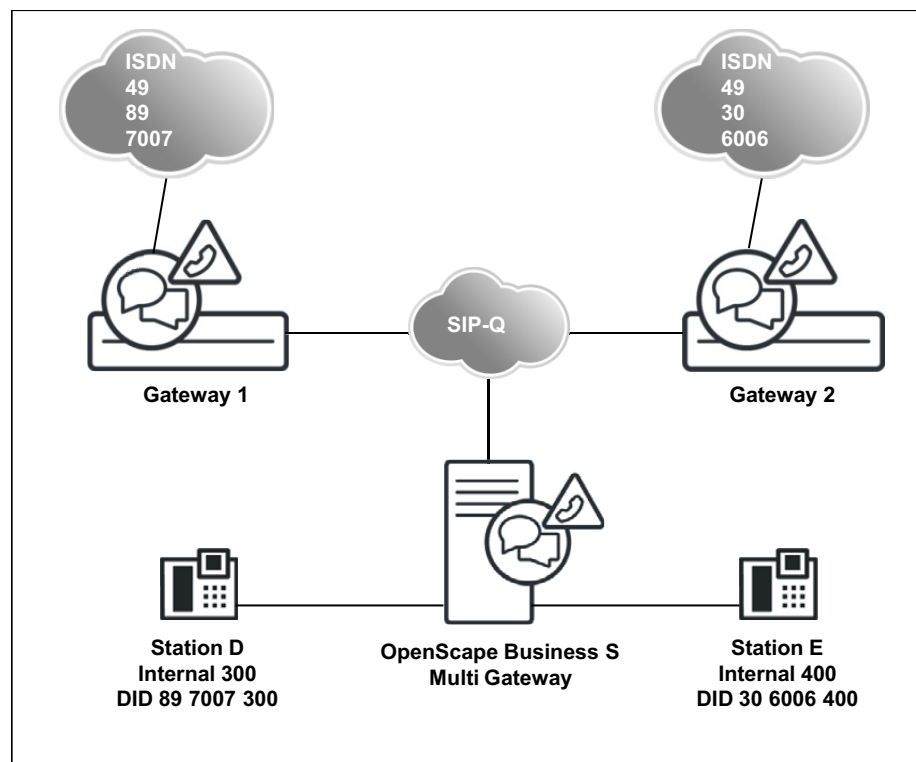

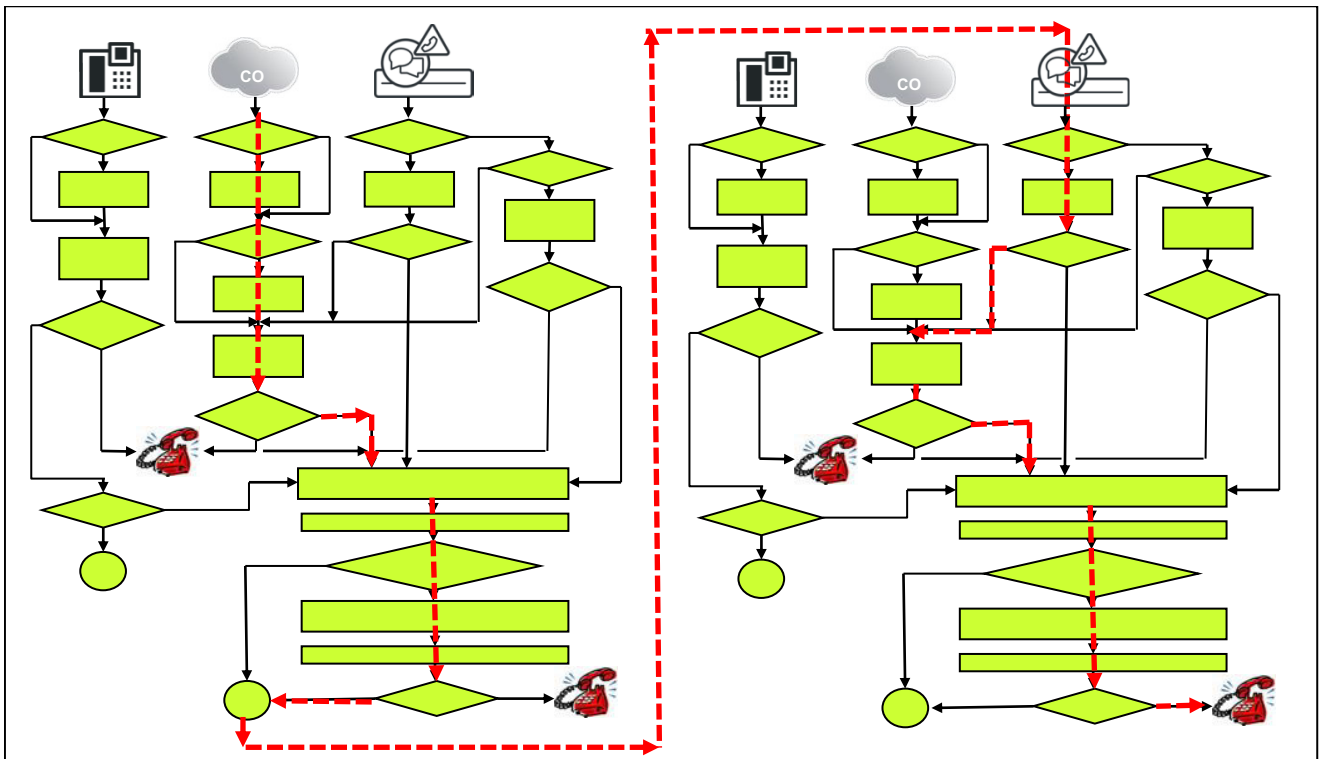

Example: Incoming call with destination number with TON = subscriber

### Configuration

Special features in this scenario:

- Gateway 1 is basically set up as in the previous scenario (gateway 1), i.e., through the basic installation first and then by running the Network wizard. The essential difference here is that the gateways are set up as slaves, and the OpenScope Business S is set up set as the master (performance, bandwidth licensing).
- In this example, only the essential differences to the previous scenario are indicated.

Basic installation for gateway 1

<b>PABX number</b>	
Country code:	49 (mandatory)
Local area code:	89 (optional)
PABX number:	7007 (optional)
<b>General</b>	
International Prefix:	00
<b>Network Parameters</b>	
Network Integration:	<input checked="" type="checkbox"/>
Node ID:	1

Network wizard for gateway 1

# Call Routing

## Digit Analysis and Call Routing

Node type

If a network is configured, one system, and only one, in the network must be a MASTER node.

This system is the MASTER node   
 This system is a SLAVE node

Enter the IP address of the MASTER node:

After 'OK & Next' you cannot undo the action by aborting the wizard.

Change Dial Rule				
	Rule Name	Dial rule format	Network access	Type
1	ISDN	A	Main network supply	Unknown
2	SIP	A	Main network supply	Unknown
3	SIP lokal	D089E2A	Main network supply	Unknown
4	MEB	E1A	Corporate Network	PABX number
5	IP-Network	A	Corporate Network	Unknown
6	Multi-Location	BA	Corporate Network	Unknown
7	Gateway call	E1A	Corporate Network	Unknown
8	COInternat	D0E3A	Main network supply	Unknown
9	Node 2 Open Num	E1A	Unknown	Unknown
10			Unknown	Unknown

In the OpenScope Business S, the destination number is already entered as a DID in the "national" format.

"BA" (Broaden All) is significant only in the gateway.

"BA" is only needed when the original destination number TON unknown has been received, i.e., contains only the "short DID" = extension portion.

### Configuring the Multi-Gateway, OpenScope Business S

- After completing the basic installation first, the Network wizard is run.
- The following is set up for each subscriber of OpenScope Business S:
  - Internal number in short format (e.g., 300)
  - DID phone number in national format (e.g., 89 7007 300)
  - Associated gateway node ID

### Basic installation of OpenScope Business S, multi-gateway

Overview

Note: At least the configuration of the 'Country code' is needed for features such as 'Internet telephony' and 'MeetMe conference'.  
 If you want your OpenScope Business in "OpenScope Business Network Integration" you should select the "Network Integration" check box and enter a node ID. In this case, make sure that this node ID is unique within the whole network integration.  
 Normally, this integration is done by a Service Technician.  
 For a standalone OpenScope Business clear the 'Network Integration' check box.

**PABX number**

Country code:  (mandatory)  
 Local area code:  (optional)  
 PABX number:  (optional)

**General**

International Prefix:

**Network Parameters**

Network Integration:   
 Node ID:

**INFO:** Only the country code needs to be entered in the system data; the rest of the complete call number is in DID entry of the subscriber.

### Network wizard of OpenScope Business S, multi-gateway

Node input

Enter the IP addresses of the corresponding OpenScope Smart Office systems in the domain.  
The Application Server IP address can be the IP address of an application board or a connected OSBiz UC BS.

	NodeId	OSBiz X / OSBiz S	Net Name	Type	Application Server	Encryption	Registration Status
	2	192.168.1.2	Master	OSBiz X	192.168.1.3	<input type="checkbox"/>	✓
Delete	1	172.30.111.22	Slave	OSBiz X		<input type="checkbox"/>	-
Delete						<input type="checkbox"/>	-

Select multi-gateway in the network configuration.

### Routes of the OpenScope Business S, multi-gateway

Trunks/Routing

- ▶ Trunks
- ▼ Route
  - route 1
  - route 2
  - route 3
  - route 4
  - route 5
  - route 6
  - route 7
  - UC Suite
  - route 9
  - SIP INT 1
  - route 11
  - Sippgate
  - Trgp751
  - Trgp752
  - Trgp753
  - Networking
  - QSIG-Feature
  - ▶ MSN assign

Route

Change Route
Change Routing Parameters
Special Parameter change

Route Name:

Seizure code:

CO code (2nd trunk code):

**Gateway Location**

Country code: 49

Local area code:

PABX number:

**PABX number-incoming**

Country code:

Local area code:

PABX number:

Location number:

**PABX number-outgoing**

The country code was already entered in the wizard.

Routing parameters: Route type CO (Central Office)

This route is assigned the route type "CO".

## Call Routing

### Digit Analysis and Call Routing

Trunks/Routing	Route
<ul style="list-style-type: none"> <li>▶ Trunks</li> <li>▼ Route</li> <li>route 1</li> <li>route 2</li> <li>route 3</li> <li>route 4</li> <li>route 5</li> <li>route 6</li> <li>route 7</li> <li>UC Suite</li> <li>route 9</li> <li>SIP INT 1</li> <li>route 11</li> <li>Sipgate</li> <li>Trgp751</li> <li>Trgp752</li> <li>Trgp753</li> <li style="background-color: #90EE90;">Networking</li> <li>QSIG-Feature</li> <li>▶ MSN assign</li> </ul>	<div style="text-align: right; margin-bottom: 5px;"> <span style="color: green;">Change Route</span>      <span style="color: green;">Change Routing Parameters</span>      <span style="color: green;">Special Parameter change</span> </div> <p>Route Name: <input type="text" value="Networking"/></p> <p>Seizure code: <input type="text"/></p> <p>CO code (2nd trunk code): <input type="text" value="0"/></p> <hr/> <p><span style="color: green;">Gateway Location</span></p> <p>Country code: 49</p> <p>Local area code: <input type="text"/></p> <p>PABX number: <input type="text"/></p> <hr/> <p><span style="color: green;">PABX number-incoming</span></p> <p>Country code: <input type="text"/></p> <p>Local area code: <input type="text"/></p> <p>PABX number: <input type="text"/></p> <p>Location number: <input type="checkbox"/></p> <hr/> <p><span style="color: green;">PABX number-outgoing</span></p> <p>Country code: <input type="text"/></p> <p>Local area code: <input type="text"/></p> <p>PABX number: <input type="text"/></p> <p>Suppress station number: <input type="checkbox"/></p> <hr/> <p><span style="color: green;">Overflow route</span></p> <p>Overflow route : <input type="text" value="None"/></p> <hr/> <p><span style="color: green;">Digit transmission</span></p> <p>Digit transmission: <input type="text" value="Digit-by-digit"/></p>

Routing parameters: call number type outgoing = National, Route type PABX

This route is assigned the route type "PABX", and the "No. and type, outgoing" must be set up with the **Local area code**.

#### 15.3.4.10 Subscriber D calls external station via the CO

Networked system in multi-gateway configuration

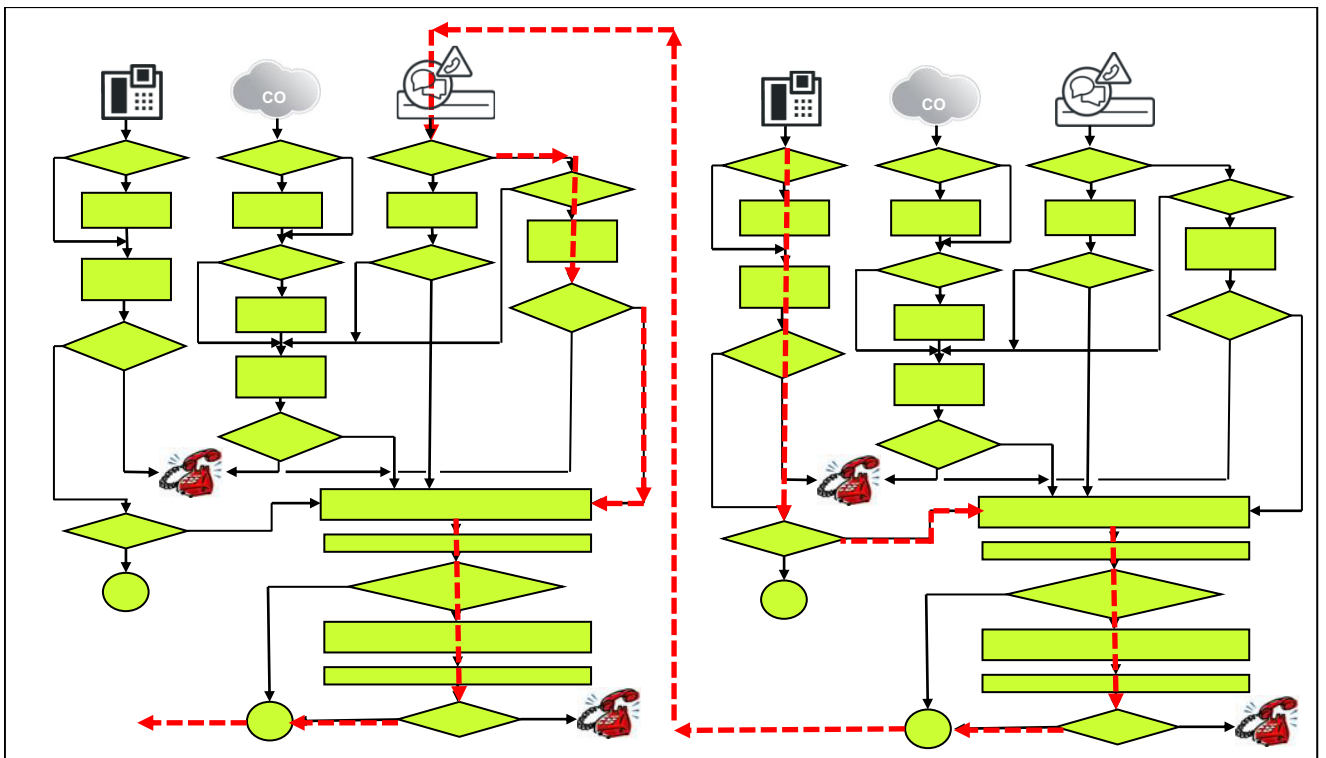
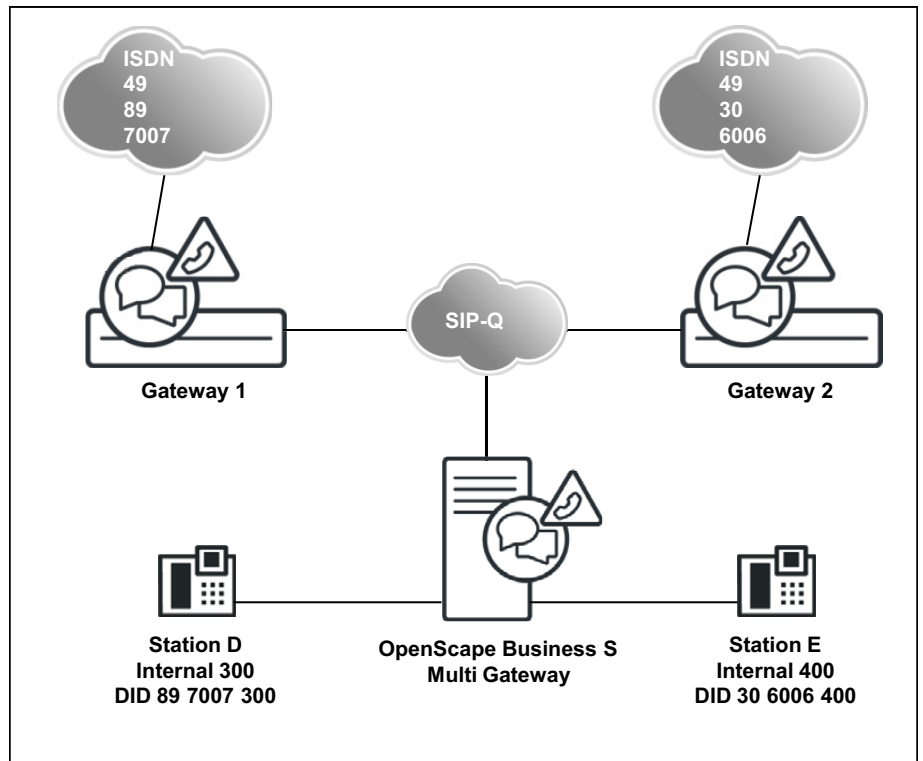

### Configuration of the OpenScope Business S, multi-gateway

Expert mode - Telephony Server

LCR

- LCR Flags
- Classes Of Service
- Dial Plan
- Routing table
  - Dial rule

Dial Rule

Change Dial Rule

	Rule Name	Dial rule format	Network access	Type
1	ISDN	A	Main network supplie	Unknown
2	SIP	A	Main network supplie	Unknown
3	SIP lokal	D089E2A	Main network supplie	Unknown
4	MEB	E1A	Corporate Network	PABX number
5	IP-Network	A	Corporate Network	Unknown
6	Multi-Location	BA	Corporate Network	Unknown
7	Gateway call	E1A	Corporate Network	Unknown

### Routing of OpenScope Business S, multi-gateway, to the gateways

LCR

- LCR Flags
- Classes Of Service
- Dial Plan
- Routing table
  - 1 - Table
  - 2 - Table
  - 3 - Table
  - 4 - Table
  - 5 - Table
  - 6 - Table
  - 7 - Table
  - 8 - Table
  - 9 - Table
  - 10 - Table
  - 11 - Table
  - 12 - Table
  - 13 - Table
  - 14 - Table
  - 15 - Table
  - 16 - Table
  - 17 - Table
  - 18 - Table
  - 19 - Table
  - 20 - Table
  - 21 - Table
  - 22 - Table
  - 23 - Table

Routing Table

Change Routing Table

Routing Table: 13 Digit-by-digit

Index	Route	Dial Rule	min. COS	Warning	Dedicated Gateway	GW Node ID
1	Networking	Gateway call	15	None	Multi-location	
2	None	None	15	None	No	
3	None	None	15	None	No	
4	None	None	15	None	No	
5	None	None	15	None	No	
6	None	None	15	None	No	
7	None	None	15	None	No	
8	None	None	15	None	No	
9	None	None	15	None	No	
10	None	None	15	None	No	
11	None	None	15	None	No	
12	None	None	15	None	No	
13	None	None	15	None	No	
14	None	None	15	None	No	
15	None	None	15	None	No	
16	None	None	15	None	No	

The setup of gateway 1 occurs as in the previous example. This also applies to gateway 2.

## 15.4 Emergency Calls

The communication system and the phones connected offer different options for making emergency calls. The administrator can configure a hotline or hotline after timeout or an emergency service.

Even if the activation period has not yet started or the communication system is in the failover period, emergency calls can always be made from the first two active telephones.



### Prerequisites

The emergency call center is reached by dialing the CO access code (e.g., 0) and the emergency number (e.g., 112). The destination number for emergency calls must therefore be dialed from applications together with the leading CO access code.

### Basic Sequence

Emergency calls are initiated by a subscriber of the communication system by dialing the CO access code and the emergency number. The emergency number is passed by the communication system on to the respective provider (PSTN or ITSP).

#### Case 1: Dialing the emergency call over the PSTN line

The emergency call is issued in the local network to which the communication system connection is assigned. The following must be observed here: All subscribers who are not in the same location as the communication system (e.g., Mobility users, CallMe users (teleworkers) or users with remote WAN-linked phones) should dial the emergency call via a cell phone or another land-line phone to issue the emergency call in the local area network of their site.

#### Case 2: Dialing the emergency call via an ITSP

Not all ITSPs support emergency calls. In this case, the LCR configuration should be used to ensure that emergency calls are routed via the PSTN.

#### Case 3: Special agreement with ITSP or PSTN providers

In cases where all subscribers of the communication system are not located at one site, but are nonetheless permanently assigned to a single site without a PSTN of its own, a customized procedure for emergency signaling can be agreed upon in cooperation with the Provider. For example, depending on the caller ID of the caller, the emergency call can be routed by the provider to the appropriate local network as agreed. These agreements are made on an individual basis and not subject to any policy.

#### Case 4: Emergency calls with Mobile Logon (IP Mobility)

Mobile Logon (IP Mobility) means that subscribers can change their phones and take their phone numbers with them.

Emergency calls work in this case, so long as the phones are logged in at the locations of the gateways. All subscribers who are not at the site of the gateway (e.g., Mobility users, CallMe users, home workers and users with remote WAN-linked phones) should dial the emergency call via a cell phone or another land-line phone to issue the emergency call in the local area network of their site.

---

**INFO:** For multi-gateway scenarios in which the Mobile Logon feature is used, special requirements apply. The appropriate configuration is described in the section "Emergency Calls in combination with Mobile Logon".

---

## 15.4.1 Hotline after Timeout / Hotline

You can activate the Hotline function for every station. You can thus define whether the connection to the hotline destination should be established as soon as you lift the handset (hotline) or after a short delay (off-hook alarm after timeout).

### Hotline after timeout

If the subscriber selects any digit during the predefined time (hotline timeout), **no** connection to the hotline destination is established.

The hotline timeout is configured centrally by the administrator and can be activated and deactivated individually for each station.

### Hotline

When the hotline is activated, the subscriber has **no** way to enter a call number. On picking up the receiver, the subscriber always reaches the predefined internal or external hotline destination automatically.

If hotline destination is set for call forwarding or call forwarding-no answer (CFNA), the calling station will always be forwarded.

### System-Specific Information

The administrator can configure six hotline destinations and the length of the hotline timeout (0-99 seconds). If the administrator specifies the value 0 for the hotline timeout, the hotline destination is called immediately.

### Dependencies

Topic	Dependency
Do Not Disturb	A caller hears the busy tone if Do Not Disturb (DND) is active at the destination called.

### 15.4.1.1 How to Configure and Change the Hotline Destination

#### Prerequisites

- You are logged into the WBM with the **Expert** profile.

#### Step by Step

- 1) In the navigation bar, click on **Expert Mode**.
- 2) Click **Telephony > Basic Settings** in the navigation tree.
- 3) Navigate in the menu tree to **System > Intercept/Attendant/Hotline**.
- 4) You can enter six different hotline destinations (**Destination call number**) under **Hotline**.

- 5) Click on **Apply**, followed by **OK**.

### 15.4.1.2 How to Change the Hotline Timeout

#### *Prerequisites*

- You are logged into the WBM with the **Expert** profile.

#### *Step by Step*

- 1) In the navigation bar, click on **Expert Mode**.
- 2) Click **Telephony > Basic Settings** in the navigation tree.
- 3) Click **System** in the menu tree.
- 4) Click on **Intercept/VPL/Hotline**.
- 5) You can change the hotline timeout (delay period in seconds) under **Hotline**.
- 6) Click on **Apply** followed by **OK**.

### 15.4.1.3 How to Configure an Off-Hook Alarm after Timeout or Hotline for a Station

#### *Prerequisites*

- You are logged into the WBM with the **Expert** profile.

#### *Step by Step*

- 1) In the navigation bar, click on **Expert Mode**.
- 2) In the navigation tree, click on **Telephony > Stations**.
- 3) In the menu tree, click **Stations**.
- 4) Click **IP Clients**, for example.
- 5) Click **System Clients**, for example.
- 6) Mark the relevant station and set the **Hotline** mode field to **Off-hook alarm after timeout** or **Hotline**.
- 7) If you have set **Hotline**, you will also need to set the **number of hotline destinations** in the **Hotline** field.
- 8) Click on **Apply** followed by **OK**.

## 15.4.2 Trunk Release for Emergency Call

If an emergency call is made, and no CO trunk is free, a forced disconnect occurs. The emergency caller is automatically assigned the free trunk.

Trunk release works for ISDN and ITSP trunks.

If all trunks are busy, subscribers can execute an automatic or manual trunk release.

- Automatic: The Least Cost Routing (LCR) feature is active, and there is an emergency number stored in the LCR.
- Manual: the "Release trunk" feature is always active for the Attendant Console and is executed via keys or codes.

#### **System-Specific Information**

The administrator can configure as many emergency numbers as required.

To ensure that automatic trunk release occurs when all lines are busy, the emergency number must be saved in the LCR dial plan and the *Expert Mode* emergency flag must be set for it.

### **15.4.2.1 How to Activate and Deactivate Trunk Release for Emergency Call**

#### ***Prerequisites***

- You are logged into the WBM with the **Expert** profile.

#### ***Step by Step***

- 1) In the navigation bar, click on **Expert Mode**.
- 2) In the navigation tree, click **Telephony > Routing**.
- 3) Navigate in the menu tree to **LCR > Dial Plan**.
- 4) Select one of the following options in the **Change Dial Plan** window:
  - If you want to activate the function, enable the **Emergency Call No** check box for the corresponding call number.
  - If you want to deactivate the function, clear the **Emergency Call No** check box for the corresponding call number.
- 5) Click on **Apply** followed by **OK**.

### **15.4.3 For U.S. and Canada only: E911 Emergency Call Service**

The enhanced E911 emergency service transmits geographical information on the caller (stored address) in addition to the phone number when an emergency call is dispatched.

The receiving station for the emergency call does not require human intervention to determine the site of the caller.

In the USA, this feature is only activated when the emergency number 911 is dialed.

Every station number must be assigned a valid DID number with LIN (location identification number) by the administrator for the E911 emergency service. Subscriber lines that are physically close to one another are given the same LIN.

The emergency call center has a database that contains all LINs and uses the transmitted LIN to identify the name and address of the party placing the emergency call.

#### Dependencies

Topic	Dependency
CLIP	LIN is activated by default for the U.S. However, if CLIP (Calling Line Identification Presentation) is activated for the USA, LIN is automatically disabled.

### 15.4.3.1 How to Edit CLIP / Lin

#### Prerequisites

- You are logged into the WBM with the **Expert** profile.

#### Step by Step

- 1) In the navigation bar, click on **Expert Mode**.
- 2) In the navigation tree, click on **Telephony > Stations**.
- 3) In the menu tree, click **Stations**.
- 4) Click **IP Clients**, for example.
- 5) Click on the **Edit Stations** tab.
- 6) Enter the 16-digit LIN for the relevant subscriber in the **CLIP/Lin** field.
- 7) Click on **Apply** followed by **OK**.

### 15.4.4 Emergency Calls in Combination with Mobile Logon

If you use the Mobile Logon feature in a multi-gateway internetwork, switching to another phone may also change the physical location. Consequently, special measures are required for the routing of emergency calls.

#### Description of the Algorithm for Dialing an Emergency Number

When a subscriber dials an emergency number (ID in the LCR), an algorithm checks whether or not an emergency number has been configured for the telephone. This is then used to produce a derived call number, which is used to route the call via the correct gateway in the internetwork.

Every number marked as an emergency number in the dial plan also features a reference to an entry in the route table. Every entry in the route table that is associated with an emergency number must be assigned a "low" class of service (COS). A low class of service means that every subscriber is authorized to call an emergency number.

### 15.4.4.1 Configuring the Emergency Scenario

The configuration of the emergency scenario shows which steps must be performed to set up emergency calling for a multi-gateway internetwork.

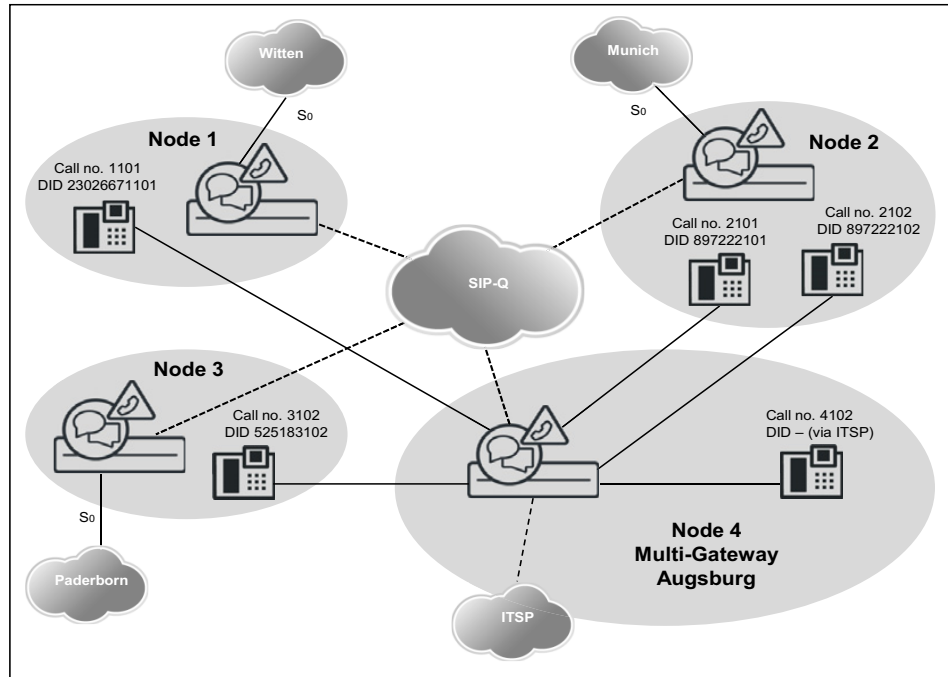

Mobile Logon is supported only within a node, i.e., location changes - and thus the special requirements for emergency calls - are only relevant for phones operated on the multi-gateway node (4). In general, all affected phones are logged in at node 4, but are physically located at different sites.

- In all affected phones, one entry is required for emergency calling (connection portion of the canonical phone number of the location node + seizure code for emergency route)
- The LCR entry (node\_4local) in the following table is only required if phones are physically present at node 4 (multi-gateway). It is also preceded by the location number which, however, is incomplete here (only country code). The prerequisite for this is an ITSP access to node 4, which supports emergency calls into the local network.

#### Handling of Emergency Numbers

- On dialing at the telephone, an LCR rule marked with an emergency flag (e.g., 0C11x) is taken.
- The emergency number that is stored in the phone (and transmitted to the system at logon) is compared with the location data of the system (country code, area code, PABX number).  
If different, a "long" emergency number is formed:
  - Removal of the access code: 0112 -> 112
  - Insertion of <LDAP seizure code><international prefix><programmed emergency number>: e.g., 112 -> 0 00 49897220 112

- The "long" emergency number is routed through the LCR, either directly to the local CO (central office) using specific LCR rules or via tie lines to the respective partner node and from there into the CO.

---

**INFO:** Since the complete location number of the local node is not entered precisely in the telephone, a suitable LCR rule must also be entered for the local emergency call at the multi-gateway location.

---

#### Setting up the Location Data for Node 4

Node 4	Gateway Node
G-Location Country	49
G-Location Local Network	
G-Location System	
International Prefix	00
National Prefix	0
LDAP seizure code	0

#### Routing parameters

Route	No. and type, outgoing	RNR type
Networking	National	Int/DID

Networking Route	
CO code (2nd. trunk code)	0

#### Node 4, telephones

Location Witten	
Call Number	1101
Emergency Number	4923026670

Location Munich	
Call Number	2101
Emergency Number	49897220

Location Paderborn	
Call Number	3102
Emergency Number	49525180

Location Augsburg	
Call Number	4102
Emergency Number	490

#### Overview of Entries Relevant for Emergency Calls in the LCR for Node 4

Dial Plan			Route table			Dial Rule		
Name	Dialed digits	Emergency operation	Route	Dedicated Gateway	Gateway ID	Dial Rule	Procedure	Type
Emergency calls <sup>1)</sup>	0C112	X	Networking	Multi-Gateway	1	E1A	Corp. Network	Unknown
Emergency calls <sup>1)</sup>	0C0110	X						
CO	0CZ							
Emergency_calls_to1	0C00492302667-0-11X	X	Networking	Mandatory	1	E3A	Corp. Network	Unknown
Emergency_calls_to2	0C004989722-0-11X	X			2			
Emergency_calls_to3	0C004952518-0-11X	X			3			
Emergency_calls_4local <sup>2)</sup>	0C0049-0-11X	X	ITSP	no		E4A	Main network supplier	Unknown

<sup>1)</sup> With the above rules in this example, only the emergency situation will be detected, but no routing will occur. The derived "long" emergency number is used to route the emergency call.

<sup>2)</sup> Since stations are physically connected at the multi-gateway location, a separate LCR rule must be entered for the local emergency call access (via the ITSP route).

### 15.4.5 E112 Emergency Call Service for Europe

The enhanced E112 emergency service transmits geographical information of the caller (stored address) in addition to the phone number when an emergency call is dispatched.

The geographical information is transmitted in a standardized XML document. The definition of the contents of this document depends on the country and ITSP. Thus you have to enter only the required subset of data you received from your ITSP (e.g. in Switzerland only the NAM field is used).



The feature is activated through configuration of emergency numbers in LCR and defining appropriate location information.

### 15.4.5.1 How to add ITSP-Loc ID to a station

#### *Prerequisites*

- You are logged into the WBM with the **Expert** profile

#### *Step by Step*

- 1) In the navigation bar, click on **Expert Mode**.
- 2) In the navigation tree, click on **Telephony > Voice Gateway**.
- 3) In the menu tree, click **ITSP Loc-ID Settings**.
- 4) Fill the **Loc-ID Name** parameter (mandatory) and the parameter(s) defined for location information you received from your ITSP (e.g. in Switzerland only the NAM field is used).
- 5) Click on **Apply** followed by **OK**.  
An index id is assigned automatically to the **ITSP Loc-ID**.
- 6) In the navigation tree, click on **Telephony > Stations**.
- 7) In the menu tree, click **Stations**.
- 8) Click **IP Clients**, for example.
- 9) Click on the **Edit Stations** tab.
- 10) Enter the relevant index id of the to ITSP Loc-ID field.
- 11) Click on **Apply** followed by **OK**.

## 15.5 Call Admission Control

Using the Call Admission Control (CAC) feature, the used bandwidth can be restricted by limiting the number of calls.

The communication system offers three ways to influence the required bandwidth:

- Limiting the number of simultaneous calls via an ITSP
- Restricting the bandwidth requirements for gateway calls
- Limiting the number of calls in network scenarios

### 15.5.1 Limiting the Number of Simultaneous Calls via an ITSP

The maximum number of calls to the ITSP can be restricted by configuring the available upload bandwidth. By reducing the number of calls, the bandwidth requirements can be reduced further.

The settings for this can be made in the **Network/Internet** and **Central Telephony** wizards.

The number of possible calls via an ITSP can be viewed in **Expert mode** under **Telephony > Voice Gateway > SIP Parameters**.

## 15.5.2 Restricting the bandwidth requirements for gateway calls

By configuring the codecs allowed for Gateway calls, the bandwidth requirements can be influenced.

If only compressed codecs are set, the bandwidth requirement is lower. When using mixed codecs the prioritization of the uncompressed codecs can be reduced so that they are used less frequently.

The corresponding settings for this are made in **Expert mode** under **Telephony > Voice Gateway > Edit Codec Parameters**.

## 15.5.3 Limiting the Number of Calls in Networking Scenarios

The communication system offers two options for controlling bandwidth in networking scenarios.

### **Limitation by restricting the number of lines to other network nodes**

By assigning a specific number of lines to other network nodes, an upper limit can be set on the number of simultaneous calls possible from and to these nodes.

### **Limitation of bandwidth through specific codec selection**

The available bandwidth can be defined by configuring the codecs used from and to the partner (destination IP address).

The corresponding settings for this are made in **Expert mode** under **Telephony > Voice Gateway > Add Destination Codec Parameters**.

## 15.6 Tenant system

From an organizational point of view, the total capacity of the communication system can be split across a maximum of six subsystems. This makes it possible for several companies to share one communication system.

The tenant system feature is implemented using existing features. This means that it is not necessary for users to explicitly configure subsystems.

Users can control allowed and denied connections between individual stations and trunks via traffic restriction groups (CON groups).

Features in tenant service include:

- Intercept

- PABX number
- Caller list
- Override
- DISA
- Speaker call
- Call detail recording
- Hotline destinations
- Text messages, advisory messages
- Internal calls
- Internal Directory
- Customer Database Printout
- Night service
- Park slot
- Traffic Restriction Groups
- Voicemail
- Toll restriction

The communication system can be used as a tenant system, which allows it to be used simultaneously by several customers. All features have the same functionality for all users.

However, certain resources must be divided among the tenants (customers). They can be assigned to one, several, or all tenants. The resources to be divided are:

- Station
- Routes
- Attendant Console
- Intercept station
- Announcement devices, voicemail
- Traffic Restriction Groups
- Door Opener
- DISA trunks

Traffic restriction groups determine the ability of tenants to access each other.

Separate hotline destinations can be configured for each tenant.

### Dependencies

Topic	Dependencies
CDRC	Only one CDRC exists for all tenants.
Internal calls	Internal calls are possible between stations in "different" tenant systems if allowed by the traffic restriction groups.
LCR	Prime Line can be configured only for the entire system.
Customer Database Printout	The database can only be printed for the entire system.

Topic	Dependencies
Internal Directory	The internal directory displays the names of all stations and speed-dialing numbers in the system.
Attendant	It is not possible to transfer undialed trunks.
Intercept	An intercept can be configured only for the entire system.

## 15.6.1 System Speed Dialing in Tenant Systems

System speed dialing in tenant systems enables the selection of specific speed-dialing destinations, depending on the internal traffic restriction (ITR) groups. To do this, a range of speed-dialing destinations can be assigned to the appropriate traffic restriction groups using the WBM.

### Dependencies

Topic	Dependencies
External station numbers	Speed-dial destinations can contain external station numbers only.
	The external station number must include the trunk group or seizure code.
SSD names	You can assign a name to each speed-dialing destination.
Entrance Telephone (Door Opener)	The entrance telephone cannot dial speed-dial numbers.
ITR groups	You cannot assign more than one speed-dial number range for the same ITR group.

## 16 Attendants

OpenScape Business provides attendant functions for every use case (e.g., AutoAttendants, phone- and PC-based attendants).

### Overview of Available Attendants

	Can be used for	Hardware	License
<b>AutoAttendants</b>			
Company AutoAttendant (UC Smart)	UC Smart	OpenScape Business X OpenScape Business S	Required
Company AutoAttendant (UC Suite)	UC Suite	OpenScape Business X3/X5/X8 with UC Booster Card or UC Booster Server OpenScape Business S	Required
IVM		Xpressions Compact board	No license required
<b>Phone-based attendants</b>			
OpenStage Attendant			
<b>PC-based Attendants</b>			
OpenScape Business Attendant	UC Smart	PC and phone, UP <sub>0E</sub>	Required
- OpenScape Business BLF	UC Smart	IP-based	
myAttendant	UC Suite	OpenScape Business X3/X5/X8 with UC Booster Card or UC Booster Server OpenScape Business S	Required

### 16.1 AutoAttendant

The AutoAttendant, together with the voicemail, provides an integrated automated Attendant service and a message store, e.g., for the company headquarters. The AutoAttendant plays a greeting to callers. During or after this announcement, the caller can be routed to an extension or mailbox automatically or by entering digits.

A wide range of functions for specific switching are available for this purpose, together with the corresponding prompts, e.g., "Press 1 for service, 2 for Sales, etc". After entering the desired digit, the caller is then automatically connected with the Sales or Service staff.

The Company AutoAttendant is not assigned to any internal call number, but to a central instance. Multiple Company AutoAttendants or mailboxes can thus be assigned to one extension. This makes it possible for the user to individually redirect to the appropriate Company AutoAttendant. Depending on the

redirection, the caller hears either the announcement of the personal mailbox or the central company announcement. It is, however, also possible to play back individual announcements via the Company AutoAttendant, regardless of the personal mailbox.

### **Function Overview**

- Intercept after announcement to a configured destination
- Status-based announcements - depending on the status of the extension (free or busy), different announcements can be played.
- Different day/night announcements (switching occurs either manually or automatically)
- Central calendar control via the automatic night service
- Suffix-dialing of any call number up to a configured length (can be deactivated)
- Speed dialing (= direct dialing external location) to configured destinations (any call number or mailbox)  
A total of 4 lists with a total of 10 destinations and one intercept destination are possible. The active list is determined by the selected greeting.
- Suffix-dialing of any call number up to a configured length. Suffix-dialing can also be disabled to prevent toll fraud.
- Multistep AutoAttendant  
AutoAttendant mailboxes can be configured as speed dial destinations (Manual 1 to 4, day/night). This allows for a concatenation of mailboxes. In this case, the Company AutoAttendant acts in the same manner as for call forwarding, i.e., the call is forwarded from one concatenated mailbox to the next, and each time the respective announcement is played. In total, up to 100 AutoAttendant mailboxes are available.
- Speed dialing  
Announcements can be disabled to guarantee fast switching.
- Announcement Prior to Answer with Parallel Signaling (without Speed Dialing)  
While the greeting is being played to the caller, the call is also simultaneously signaled to the subscriber acoustically (and visually). If the subscriber picks up the call, the announcement is interrupted, and the subscriber is connected to the caller. If the subscriber does not pick up the call, the announcement is played in a loop until the caller hangs up or is routed through the call management.
- Busy tone detection
- Forwarding of fax calls (automatic fax tone recognition) to a preconfigured Fax destination.
- Automatic recall  
In the case of a recall (except for fax calls), the caller is forwarded to the connected mailbox, if such a mailbox is available and message recording has been enabled.

---

**NOTICE:** In order to enable an automatic intercept from the voicemail system to the attendant console, the attendant code must be entered internally (default 9, USA 0).

---

---

**NOTICE:** AutoAttendant mailboxes can only be administered from a telephone (TUI). This is why the password for the AutoAttendant mailbox should differ from the password for the personal mailbox of the phone!

---

### Use Cases

- **Example 1: Independent standby or emergency services announcements**  
Outside business hours, the customer is redirected to the AutoAttendant (e.g., via the night service). The AutoAttendant connects to the respective on-duty service technician on request and offers the option of leaving a message in a central mailbox. In this case, one announcement enables redirection to the various mobile phone numbers of the service technician.
- **Example 2: Different Sunday services for medical practices**  
It is now no longer necessary to record the currently applicable Sunday service on the answering machine and to replace the AB cartridge. The customer configures as many AutoAttendants as the number of available representatives. The AutoAttendants are recorded once and activated each weekend with a redirection (night service) to the appropriate AutoAttendant. Here the situation is reversed: several different announcements lead to the same mailbox.

## 16.1.1 Company AutoAttendant (UC Smart)

The Company AutoAttendant (UC Smart) is the Attendant Console of the UC solution UC Smart. It can be used as a personal AutoAttendant and as a central AutoAttendant. The initial setup is performed via the WBM, after which it can subsequently be controlled and configured over the telephone.

The Company AutoAttendant (UC Smart) can be operated in two modes:

- **Personal AutoAttendant**  
The personal AutoAttendant is assigned to a subscriber or group and responds to the call number of the originally called, redirecting subscriber or group (e.g., 12345678-100).  
The personal AutoAttendant is reached via the "voicemail" hunt group (default call number: 351). Operation occurs via SmartVM ports (EVM ports) of type "PhoneMail", which must all be assigned to this hunt group.  
Parallel operation with UC Suite is not possible.
- **Central AutoAttendant**  
The central AutoAttendant is used as a central attendant console and responds to its own call number (e.g., 12345678-0). Regardless of whether

a direct call to the AutoAttendant or a diverted call is involved, the behavior is always the same.

The central AutoAttendant is reached via one or more of its own hunt groups (default call number: 352). Operation occurs via SmartVM ports (EVM ports) of type "Standard", which can be assigned to one or more hunt groups (max. 100).

By default, a Company AutoAttendant (group index 3) is configured with 2 SmartVM ports. The names and types of ports can be changed with the Central Telephony > SmartVM wizard (see also [How to Configure the Voicemail Box \(SmartVM\)](#)).

The speed dial list and the greetings upload be changed in Expert mode under Telephony > Auxiliary Equipment > SmartVM (see also [How to Load, Save and Delete Individual Greetings](#)). Additional (max. 99) Company AutoAttendants (UC Smart) can be likewise set up and activated.

Parallel operation with UC Suite is possible.

The Company AutoAttendant (UC Smart) requires a license (Company AutoAttendant license). If no license is present, the "rules" of the Company AutoAttendant are ignored, and calls are forwarded to the central intercept position.

### 16.1.1.1 How to Configure an Established Company AutoAttendant

As an example, for calls during the day, an announcement before answering is to be set up with a recording option (e.g., mailbox 100). During the night, after the appropriate announcement, calls are to be intercepted and sent directly the night voicemail box with a recording option (also mailbox 100).

#### **Prerequisites**

- You are logged into the WBM with the **Expert** profile.
- UC Smart has been activated.
- By default, during day and night service, an intercept to the intercept position occurs after the announcement.
- By default, the speed-dial function and suffix-dialing are not enabled.

#### **Step by Step**

- 1) In the navigation bar, click on **Expert Mode**.
- 2) Click on **Telephony > Auxiliary Equipment** in the navigation tree.
- 3) In the menu tree, click on **Auxiliary Equipment > SmartVM**.
- 4) Click on **AutoAttendant** in the menu tree.
- 5) Clear the **Intercept after announcem.** check box in the row of the desired AutoAttendant (e.g., 352) to enable the entry of speed dial digits during the greeting.
- 6) Select the **no suffix-dialing** check box. As a result, only the entry of speed dial digits will be possible (i.e., no internal call numbers can be entered).



- 7) Click on **Apply** followed by **OK**.
- 8) Click in the menu tree on **AutoAttendant** and then on the entry for the desired AutoAttendant (e.g., 352).
- 9) Click on the **Edit Speed Dial/Intercept Dest. Day** tab.
- 10) Select the station for the intercept position (e.g., station 100) from the **Select** drop-down list in the **Speed dial 0** row and then select the entry **Mailbox** in the **Type** drop down list.
- 11) Select the station for the intercept position (e.g., station 100) from the **Select** drop-down list in the **Intercept** row.
- 12) Click on **Apply** followed by **OK**.
- 13) Click on the **Edit Speed Dial/Intercept Dest. Night** tab.
- 14) Select the station for the intercept position (e.g., station 100) from the **Select** drop-down list in the **Intercept** row and then select the entry **Mailbox** in the **Type** drop down list.
- 15) Click on **Apply** followed by **OK**.
- 16) Click on **SmartVM** in the menu tree.
- 17) To avoid a two-fold greeting for the Intercept voicemail box, select the entry **None** from the **Greeting** drop-down list in the row of the intercept position (e.g., station 100). This causes the signal tone for recording to immediately follow the greeting of the Company AutoAttendant.
- 18) The greeting of the Company AutoAttendant can be changed through a telephone or via the Expert Mode > Maintenance > SmartVM (see [Configuring the Voicemail Box \(SmartVM\)](#)).

### 16.1.1.2 How to Set up a New Company AutoAttendant

#### *Prerequisites*

- You are logged into the WBM with the **Expert** profile.
- UC Smart has been activated.
- Required licenses

#### *Step by Step*

- 1) In the navigation bar, click on **Expert Mode**.
- 2) First, configure the hunt group:
  - a) In the navigation tree, click **Telephony > Incoming Calls**.
  - b) Click **Incoming Calls > Groups/Hunt groups** in the menu tree.
  - c) Click on the **Add Group** tab.
  - d) Enter the station number of the new AutoAttendant (e.g., 353) in the **Station Number** field.

- e) Enter the DID number of the new AutoAttendant in the **Direct inward dialing number** field (e.g., 353).
  - f) Enter the name of the new AutoAttendant in the **Name** field (e.g., AutoAttendant 353).
  - g) Select **Cyclical hunt group** from the **Type** drop-down list.
  - h) In the **Group member** area, select the desired AutoAttendant port (e.g., **745 SmartVM 7**) from the Call No drop-down list.
  - i) Click on **Apply** followed by **OK**.
  - j) To add another AutoAttendant port of the hunt group, click in the menu tree under **Groups/Hunt groups** on the desired AutoAttendant and then on the **Add member** tab. Then select another AutoAttendant port there (e.g., **746 SmartVM 8**) under **Station Number**.
  - k) Click on **Apply** followed by **OK**.
- 3) Configure the AutoAttendant mailbox:
- a) Click on **Telephony > Auxiliary Equipment** in the navigation tree.
  - b) Click on **Auxiliary Equipment > SmartVM** in the menu tree.
  - c) Click on **AutoAttendant** in the menu tree.
  - d) Set the two check boxes as required in the row of the desired AutoAttendant (e.g., 353):  
  
**Intercept after announcem.:** When activated, the caller can enter a speed dial digit for a switching option during the greeting.  
  
**No suffix-dialing:** If enabled, only speed-dial digits and no internal call numbers can be entered.
  - e) Click on **Apply** followed by **OK**.
  - f) Click on **SmartVM** in the menu tree.
  - g) Click on the
  - h) On the **Edit SmartVM Mailboxes** tab, select the desired greeting under **Greeting** in the row of the desired AutoAttendant.
  - i) Select the **AutoAttendant** check box in the row of the desired AutoAttendant.
  - j) Click on **Apply** followed by **OK**.
- 4) Configure the switching options (e.g., "0" to connect and "1" for an announcement):
- a) Click in the menu tree on **SmartVM** and then on **AutoAttendant**.
  - b) Click in the menu tree under **AutoAttendant** on the entry of the desired AutoAttendant (e.g., 352).
  - c) Click on the **Edit Speed Dial/Intercept Dest. Day** tab.
  - d) In the **Speed dial 0** row, enter the phone number to which calls should be connected under **Call number** and select the entry **Call no.** in the **Type** drop-down list.

- e) Select the station for the intercept position (e.g., station 100) from the **Select** drop-down list in the **Speed dial 1** row and then select the entry **Mailbox** in the **Type** drop down list.
- f) Select the Company AutoAttendant (e.g., 353) from the **Select** drop-down list in the **Intercept** row.
- g) Click on **Apply** followed by **OK**.
- h) If the flag **no suffix-dialing** is disabled, internal numbers can also be dialed during the greeting. To prevent toll fraud, the **Call number length delimitation** should be checked and restricted so that no external phone numbers can be dialed (see **Expert Mode > Telephony > SmartVM > Edit SmartVM parameters**).

## 16.1.2 Company AutoAttendant (UC Suite)

The central Company AutoAttendant (UC Suite) is an attendant console which can only be configured by the administrator. To facilitate the installation and setup, there are five templates that can be customized by the administrator.

The administrator can configure the Company AutoAttendant (UC Suite) on the basis of rules and schedules. Schedules also make it possible to offer advanced selection options such as dialing by name, for example.

### 16.1.2.1 Schedules

This schedule and the rules contained in it (Call Control Vectors or CCVs) define how incoming calls are to be handled on specific dates and at specific times.

For example, on work days, separate rules may be defined for the morning shift (from 6:00 to 14:00 hours), the afternoon shift (14:00 to 22:00 hours) and the night shift (from 22:00 to 06:00 hours). Similarly, a weekend rule can be defined for the weekends. For each of these rules, you can define whether an announcement is to be played, for example, and/or the destination to which the calls are to be forwarded.

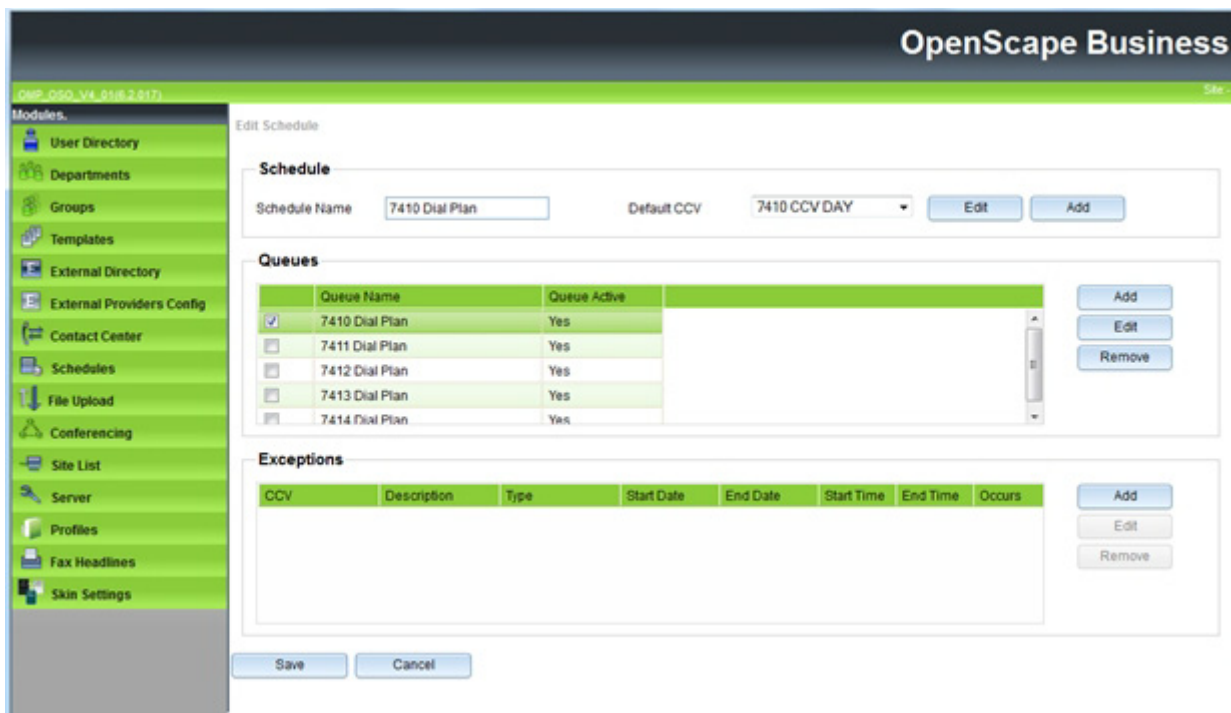

A schedule, in turn, must have at least one rule (called a Call Control Vector or CCV) assigned to it. The rules determine how incoming calls are to be handled during the time period to which the schedule applies. Rules apply only to calls and not to faxes and e-mails.

Rules are created with the graphical rule editor (CCV Editor) by combining predefined CCV objects and can be saved under a user-defined name upon completion.

Saved rules can be assigned to one or more schedules as a default rule (default CCV) or an exception rule (exception CCV). They can be opened, edited and saved again at any time by using the rule editor.

After a schedule has been assigned a default rule (default CCV), this schedule can be saved under a user-defined name. A schedule with an assigned default rule applies to a queue 24 hours a day, 365 days a year. If different rules are to be applied at certain times (breaks, weekends, holidays, vacations, etc.), these can be assigned to the schedule as exception rules (Exception CCV). This means that you can define how incoming calls are to be handled during the holiday schedule, for example. Holiday schedules have precedence over the other schedules and rules.

### Rule Editor (CCV Editor)

The Rule Editor is used to create rules from predefined CCV objects. The arrangement of the CCV objects and their properties determine how incoming calls are to be handled.

The following predefined CCV objects are available:

---

**INFO:** For all of the named CCV objects, the two general properties listed below also apply:

**Description:** Optional entry to describe the CCV object, e.g., Greeting.

**Process digit:** specification of the digit(s) required without blanks, commas or other characters. The specification refers to the preceding CCV object. If 9 was specified there under Accepted Digits, then 9 must also be entered here.

---

- **Play Message**

Causes the desired message to be played. Any audio file present in the UC Suite can be selected. In addition, a new audio file can be imported into the UC Suite or a new announcement can be recorded and then imported as an audio file into the UC Suite.

The playback of the announcement seizes one respective Media Stream channel.

Properties:

- **File Name:** Selection of an announcement (audio file in WAV format)
- **Interrupt Digits:** specification of a key or key combination on the dial pad with which callers can stop the playback of an announcement.
- **File Manager:** Using this button, it is possible to directly upload an audio file in wav format or create a new voice file with the recording device.

- **Disconnect Caller**

Causes the call to be disconnected.

After this CCV object, no further CCV object may be inserted.

- **Go to CCV**

Causes a loop to another CCV object

Property:

- **Target CCV:** Selection of the CCV object

- **Process after digits**

Causes the next CCV object(s) to be executed, depending on the digits specified there (process digit).

Properties:

- **File Name:** Selection of one or more announcements (audio file in WAV format)
- **Playlist:** List of selected announcements (audio file in WAV format) in the order in which they are played
- **Digits Timeout:** Time, in seconds, for which the communication system waits for the input of digits.  
If the required digits are not entered fully within the specified time, the message (announcement) is played again.
- **Link To:** List of digits with destination.  
The digits and destinations can be added, edited and removed.

- **File Manager:** Using this button, it is possible to directly upload an audio file in wav format or create a new voice file with the recording device. The contents of the Playlist are presented in the Rule Editor by a tool tip on hovering with the mouse pointer over the CCV object.

- **Single Step Transfer**

This function depends on the **Normal Attendant Console SST** setting (WBM, **Expert mode: Applications > OpenScape Business UC Suite > Server > General Settings**):

- **Normal Attendant Console SST** enabled (default setting; not for U.S.): Causes the call to be transferred, regardless of whether the destination is free, busy or unavailable.

---

**INFO:** For stations with call waiting rejection enabled, the call is switched through only if the destination station is free. No call waiting on busy occurs.

---

- **Normal Attendant Console SST** disabled (default setting, only for U.S.): Causes the call to be transferred if the destination is free. If the destination is busy and call waiting rejection is disabled, or if the destination is unavailable, an announcement is played back to the caller. The caller can then optionally choose to leave a message in the voicemail box of the called subscriber or select the call number of another destination. If the destination is busy and call waiting rejection is enabled, the call is not switched through.

After this CCV object, no further CCV object may be inserted.

Property:

- **Target Extension:** specification of the internal call number or external DID extension with the number of the CO trunk. Blanks, commas and other characters are not allowed.

The call number of the target extension is displayed in the CCV object.

---

**INFO:** After Single-Step-Transfer, the system disconnects the call after ringing for 5 minutes.

---

- **Record In Mailbox**

Causes the call to be sent to the desired voicemail box of a subscriber or a voicemail group

After this CCV object, no further CCV object may be inserted.

Property:

- **User Mailbox:** specifies the station number of the voicemail box of a subscriber or voicemail group

The station number and the name of the voicemail box or voicemail group are shown in the Rule Editor by a tool tip on hovering with the mouse pointer over the CCV object.

- **Supervised Transfer(also called screened transfer)**

Causes the call to be transferred to an internal destination. During the transfer, Music on Hold (MOH of UC Suite) is played back to the caller. In contrast to the single-step transfer CCV object, two further CCV objects must be inserted here. This is because we now need to define how the communication system should behave if the call destination is busy or does not answer the call. Usually, an announcement is played to the caller in such cases.

Properties:

- **Target Extension:** Specification of the internal phone number. Only internal call numbers are supported in the own node. Forwarding to external destinations, virtual stations, additional AutoAttendants, UCD (incl. Contact Center), Mobility users as well as external CallMe destinations is not allowed! For these scenarios, the SST (single-step transfer) should be used.
- **Ring Time Out (SEC.):** Time, in seconds, within which the call must be accepted. If the call is not answered within the specified time, it is returned to the communication system, and the next CCV object is used.

---

**INFO:** The time specified here must be shorter than the time configured for call forwarding (the default setting for call forwarding = 15 seconds). See *Administrator Documentation, Functions at the Telephone*.

---

- **Pull back call if destination device is forwarded / deflected:** Option (only applicable for internal call number.) If this option is enabled, the call destination is first checked, and if a forwarding destination or deflection has been set for it, the call is returned to communication system, and the next CCV object is used.
- **Check Presence status when transferring call:** Option If this option is enabled, the presence status of the call destination is checked, and if this status is any presence status other than Office, the call is returned to communication system, and the next CCV object is used.

- **Dial By Name**

Causes the caller to be prompted to enter the first three letters of the desired subscriber's last name via the dial pad.

If a unique subscriber name with the entered initial letters is found, a connection is established.

If there are several subscriber names with the entered initial letters, these subscriber names are announced to the caller (max. 10 subscribers). If a subscriber has no recorded name announcement, the call number is announced instead. After selecting the desired subscriber, a connection is made.

If none of the subscribers match the entered initial letters, the caller receives a corresponding message.

---

**INFO:** The keys on the dialpad respond to the first press of a key. With each key pressed, the system tries to determine whether there are subscriber last names with the letter assigned to that key.

Example: Let us assume the internal phone book has five last names with the initial letters t, u and v: Taylor, Taler, Ullrich, Vasquez and Volterra. To establish a connection with the subscriber Taylor, following keys must be pressed: 8 2 9

---

After this CCV object, no further CCV object may be inserted.

Properties:

- **Method:** Selection of **Transfer To Extension** or **Record In Mailbox**.  
Depending on the method selected, a connection to the desired extension or its voicemail box is established. Note that only internal extensions for which the first and last names of the subscriber are entered in the internal directory are supported here.
- **Dial By Extension**  
Causes the caller to be prompted to enter the station number (extension) of the desired subscriber via the dial pad.  
If the caller dials the station number of a virtual station, the caller is prompted to enter another station number. A connection is then established. If the desired subscriber does not respond, the call is accepted by his or her voicemail box.  
After this CCV object, no further CCV object may be inserted.  
Properties:
  - **Method:** Selection of **Transfer To Extension** or **Record In Mailbox**.  
Depending on the method selected, a connection to the desired extension or its voicemail box is established. Note that only internal extensions in the network for which the phone number is entered in the internal directory are supported here.
- **Set language**  
Selects the language for each standard announcement based on the phone number of the caller. It should be noted that only standard announcements (i.e., system announcements) and no personal greetings are taken into account here.  
For example, it is possible to have German announcements played back to callers with the country code 0049 and French announcements for callers with the country code 0033.  
Properties:
  - **Default language:** Drop-down list to select a language.  
The language selected here is used for all phone numbers for which no specific language was defined.
  - **Pattern:** Specifies the phone numbers to which a particular language is to be assigned.  
The following placeholders can be used \* = any digit, ? = any digit.



- **Language:** Drop-down list to select the language to be assigned to the relevant phone numbers (matching **Pattern**).

A language can be assigned to any number of different phone numbers (matching **Pattern**).

- **CLI Routing**

Causes the forwarding of a call to one or more sequential CCV objects based on the caller's number.

For example, it is possible to first have a German announcement played back to callers with the country code 0049 (CCV object **Play Message**) and then have the call forwarded to an internal phone (CCV object **Single Step Transfer**).

Properties:

- **Standard:** Drop-down list to select the CCV object.  
The CCV object selected here is used for all phone numbers for which no specific destination was defined.
- **Pattern:** Specifies the phone numbers to which a specific CCV object is to be assigned as the destination.  
The following placeholders can be used \* = any digit, ? = any digit.
- **Description**  
Provides an explanation.  
For the **Pattern** 0049 (= country code for Germany), for example, Germany can be entered.  
The text entered here will appear in the Rule Editor.
- **Target:** Drop-down list to select the CCV object that is to be assigned as a destination to the related phone numbers (matching **Pattern**).

A CCV object can be assigned as a destination to any number of different phone numbers (matching **Pattern**).

- **Branch on variable**

Causes the forwarding of a call to one or more sequential CCV objects based on a given condition.

You can thus define, for example, that an announcement (such as "Please call again later ...") should be played back to callers as soon as there are more than 20 calls in a queue.

Properties:

- **Variable:** Selection of **Calls** or **Available agents**.  
Depending on the selected variable, the number of calls waiting in a queue or the number of available agents (including agents in wrap up time) is used as the defined condition. In the associated drop-down list, the condition (**less than, greater than, less than or equal to, equal to or greater than, equal to**) must be selected, and the comparison value must then be entered in the corresponding input field.
- **True branch:** Drop-down list to select the CCV object that is to be used as a destination when the condition is satisfied.
- **False branch:** Drop-down list to select the CCV object that is to be used as a destination when the condition is not satisfied.

The number of available agents in a queue is affected by the following status changes of the agents:

- Login of an agent into the queue using "Anmelden/Login": --> +1

**Attendants**  
AutoAttendant

- Logout of an agent from the queue using "Abmeldung/Logout": --> -1
- Agent in the status "Break":-->-1
- Agent in the status "Available after Break":--> +1

The number of available agents in a queue is **not** affected by the following status changes of the agents:

- Agent in the status "Ringing"
- Agent in the status 'Talking'
- Agent in the status "Wrap up"
- Agent in the status "Missed Call"
- Agent in the status "Overdue"

### 16.1.2.2 Templates

The following templates are predefined, standardized templates for the Company AutoAttendant (UC Suite), but can be changed as desired and adapted to specific needs.

#### Template 1 - 7410 CCV: Call with Switching (without Voicemail)

An announcement is played for the caller. The caller is then prompted to press a button (digit) and is connected to a subscriber. If the caller does not press any button, the call is switched to the intercept position (default 100).

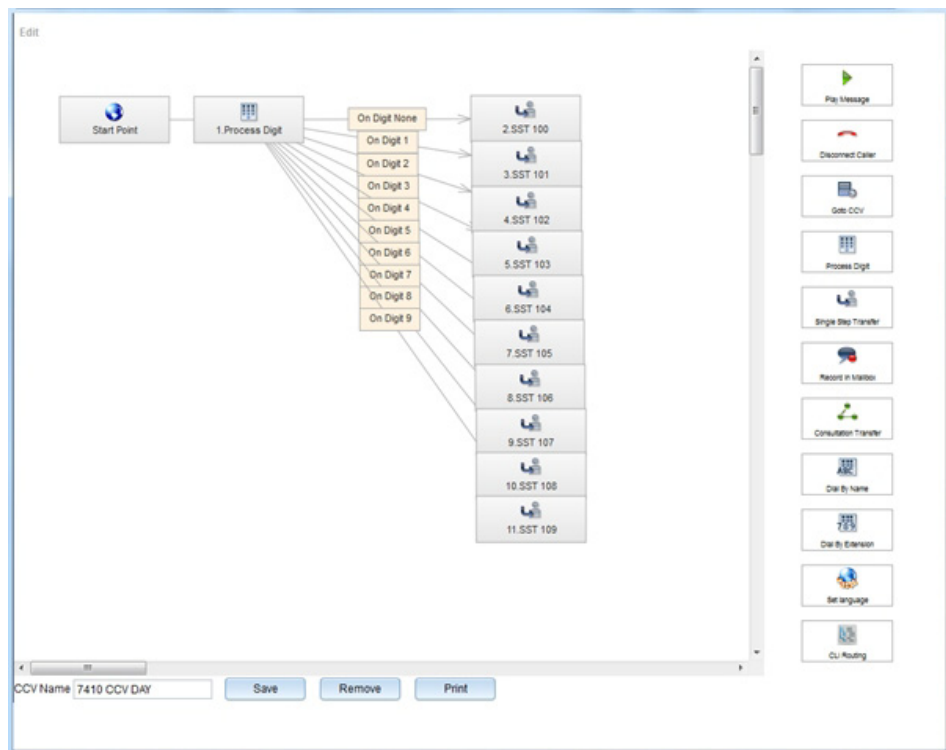

### Template 2 - 7411 CCV: Announcement before Answering

An announcement is played for the caller. The call is then switched to the intercept position 100.

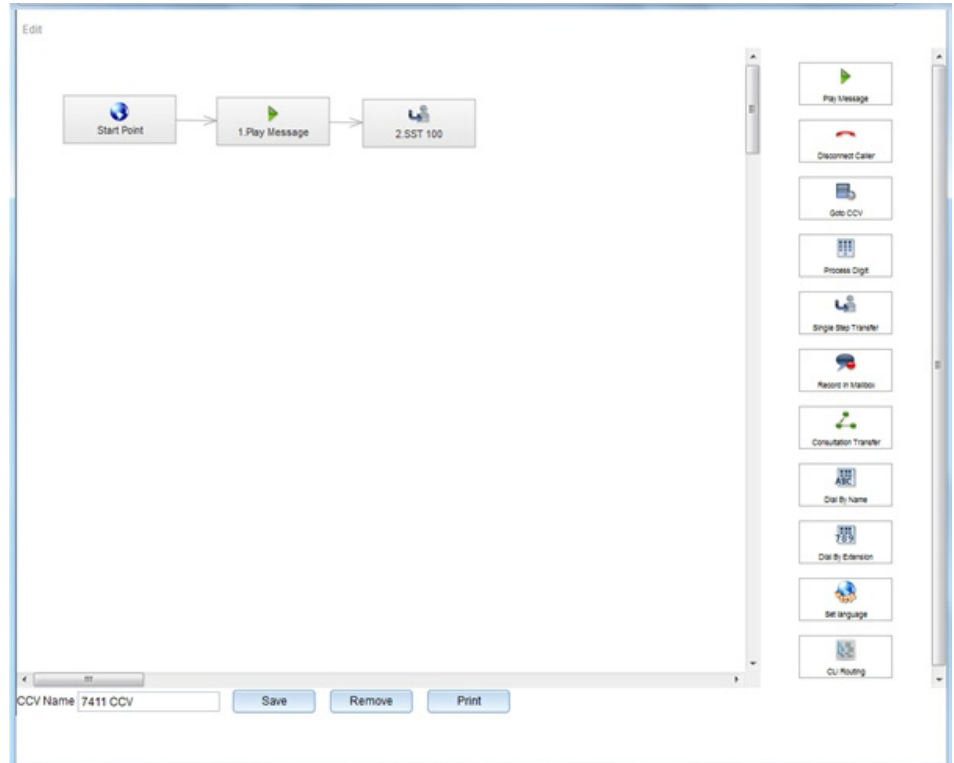

### Template 3 - 7412 CCV: Call Outside Business Hours

An announcement is played for an incoming call outside business hours. The call is then disconnected.

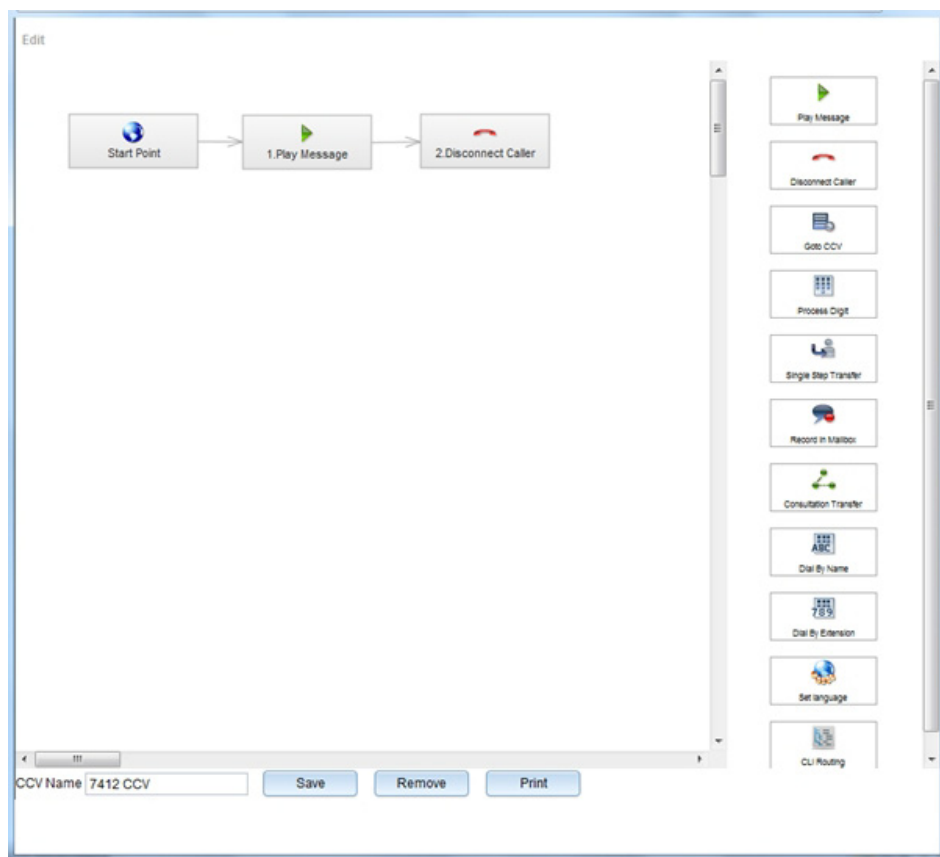

#### Template 4 - 7413 CCV: Call Outside Business Hours with Call Forwarding to Voicemail

An announcement is played for an incoming call outside business hours. The caller is then prompted to optionally record and leave a message in a voicemail box.

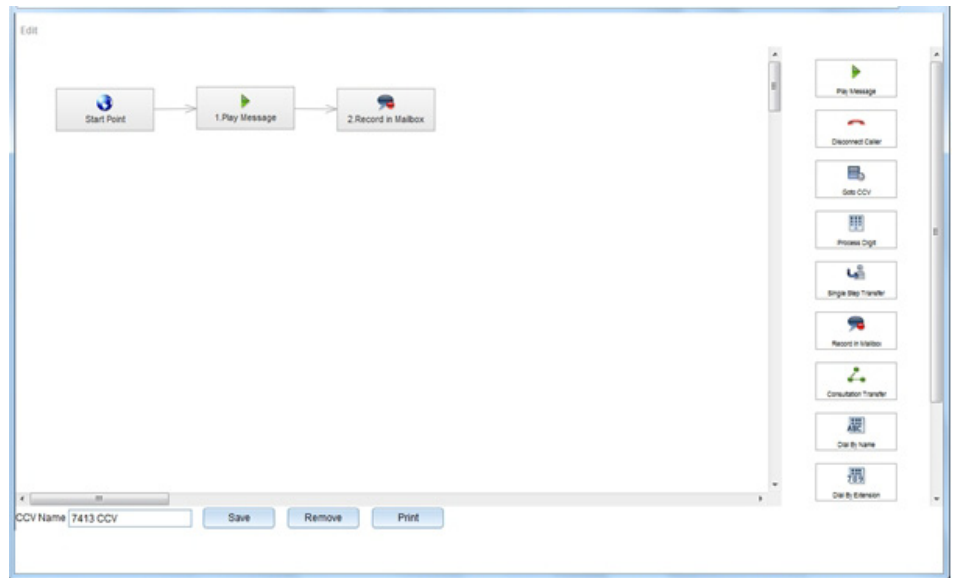

### Template 5 -7414 CCV: Dial by Extension U.S. Feature

An announcement is played for the caller. If the caller does not enter any further digits, the call is routed to the CCV Dial by Extension. If the caller presses digit 1, the call is switched to the intercept position (default 100).

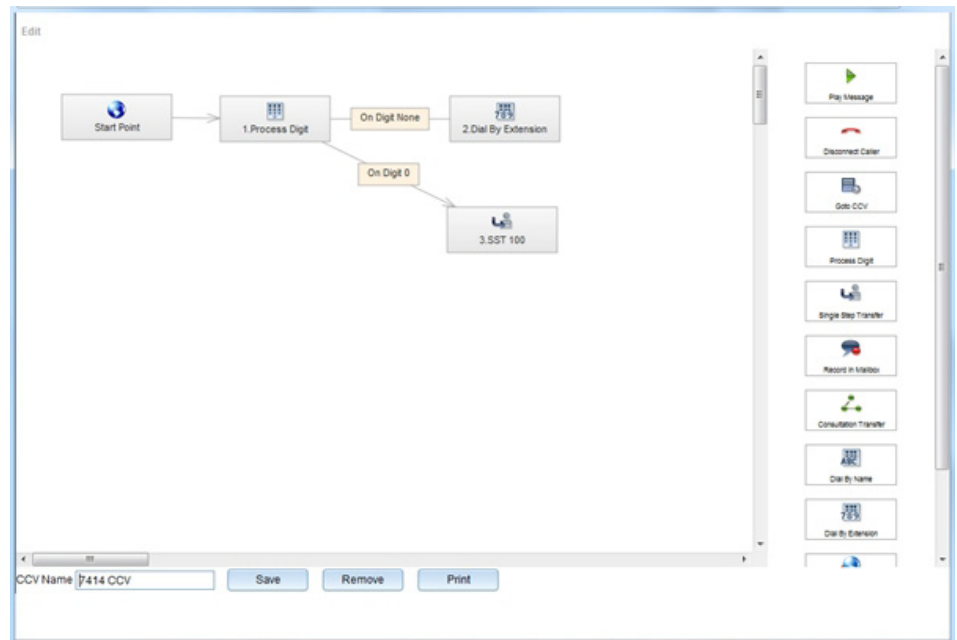

### 16.1.3 Xpressions Compact

Xpressions Compact provides an integrated AutoAttendant solution for your communication system. Up to 500 mailboxes are available with a recording capacity of 100 hours.

The AutoAttendant mailbox includes not only the mailbox for the Attendant Console, but also the option of recording messages. Incoming calls can be forwarded to:

- any extension
- a subscriber or guest mailbox
- an information mailbox
- some other user-specified destination, including external destinations
- a pre-defined destination depending on the number (10 destinations are available; no greeting is played in this case)
- an Attendant Console

Xpressions Compact features:

- Call forwarding to a mailbox
- Distribution lists for voice messages (20 lists are possible, with 499 destinations each)
- Message broadcasting
- Message Waiting Indicator
- Voice to E-mail
- Live Recording
- Notification call (SMS and pager possible)
- Forwarding messages by choice of name
- Forwarding of fax calls
- Statistics for Attendant mailboxes
- Central voice mailbox
- Access protection (3 to 8 digit password)

#### **More Information**

For more detailed information, refer to the Xpressions Compact Administrator Documentation

## 16.2 OpenStage Attendant

Attendant functions can be performed using a specially configured OpenStage telephone. The OpenStage Attendant is also an intercept position.

OpenStage Attendant is the destination for all incoming non-DID calls and calls for which no users could be reached (intercept calls) via the call allocation criteria. The attendant then routes these calls to the correct destination.

The following OpenStage phones can act as an Attendant:

- OpenStage 30
- OpenStage 40
- OpenStage 60
- OpenStage 80

#### **Key layout**

On OpenStage telephones configured as attendant consoles, the programmable function keys are assigned as follows:

- Night service
- Directory (phone book)
- Queued calls
- Override
- Hold
- External 1
- External 2 (not for OpenStage 40)
- Empty unassigned key (not for OpenStage 40)

## **16.3 OpenScape Business Attendant**

The OpenScape Business Attendant provides switching functions as well as the connection of a phone book for OpenScape Business. In a network, the OpenScape Business Attendant can be expanded to show network-wide BLF and presence information.

**Attendants**  
OpenScope Business Attendant

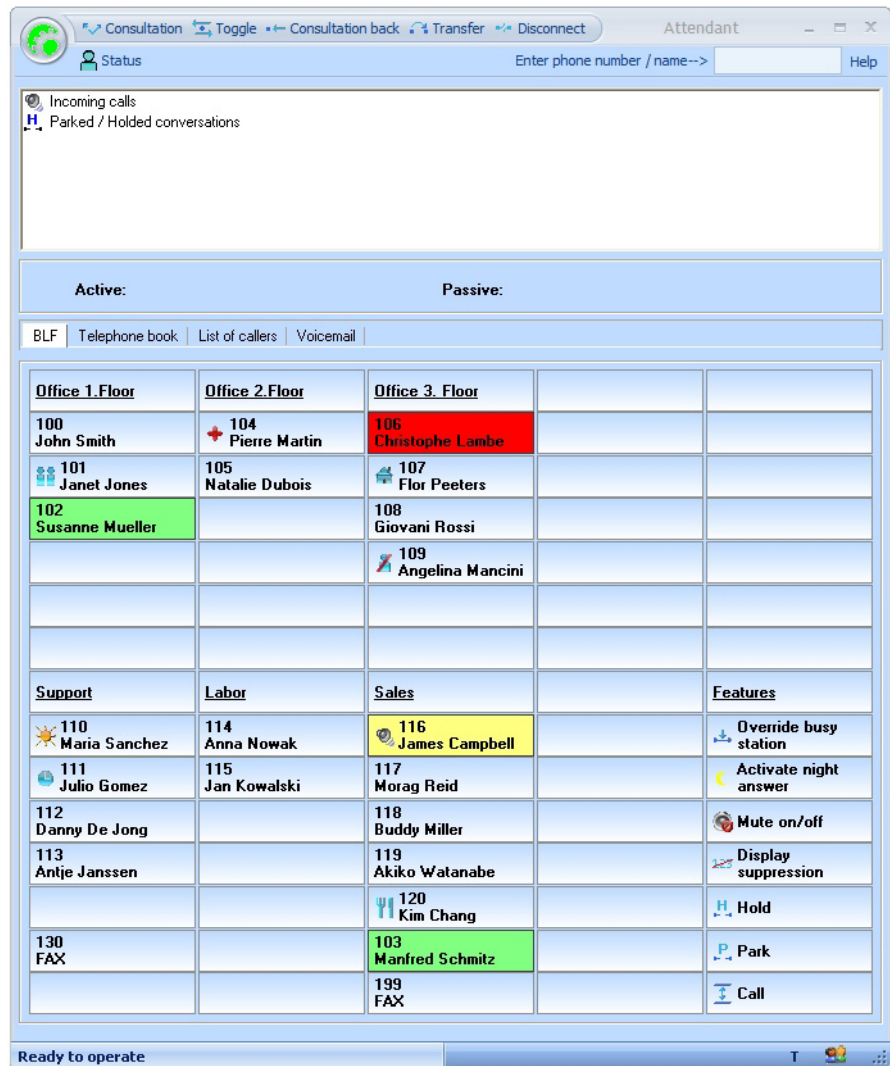

Main attendant functions:

- Manage waiting or accepted calls
- Data of the active call
- Parked, held calls
- Call List
- Journal for answered, missed and outbound calls
- Personal VoiceMail

Directory (phonebook) application:

- Outlook contacts
- LDAP (connection via OpenDirectory Service)
- Personal directory

BLF status:

- Free, Busy, Called, Forwarded

Presence visibility:



- Office, Meeting, Sick, Break, Out of the Office, Vacation, Lunch, Gone Home
- Change the presence status for users within your own node (currently not possible for users from other nodes)

Two different "styles" are available for customizing the OpenScape Business Attendant user interface.

You can connect a maximum of eight OpenScape Business Attendants per communication system (a maximum of eight licenses per OpenScape Business X1/X3/X5/X8 and Business OpenScape Business S).

OpenScape Business Attendant is licensed via the WBM.

### **Technical Requirements**

- Standard Windows PC
- Possible use of a Terminal Server when using HFA telephones (see [Prerequisites for UC Suite PC Clients](#) for the related prerequisites)
- USB interface or LAN interface, depending on the telephone used
- Screen with a resolution of min. 1024x768, optional second screen to display the second BLF
- Video card with 16-bit color depth (min. 256 colors)
- Internet access for support or updates

### **Operating System**

- Microsoft Windows 10 / 8.1 / 8 / 7 (both 32-bit or 64-bit are possible)
- Microsoft Windows Vista (32 bit)
- Microsoft Windows Server 2015 (32 bit / 64 bit) as Microsoft Terminal Server
- Microsoft Windows Server 2012 (32 bit / 64 bit) as Microsoft Terminal Server
- Microsoft Windows Server 2008 R2 (64 bit) as Microsoft Terminal Server

Support for OpenScape Business Attendant for Microsoft Windows XP and Microsoft Windows Server 2003 will end at the same time as the end of support for these products by Microsoft. The product will still be supported, but will no longer be tested in detail.

### **Supported Phones**

- Openstage 40/60/80 HFA
- openStage 30T/40T/60T/80T

Some of the older devices (e.g., optiPoint 410/420/500) are still supported. Please refer to the relevant release notes to see which devices have been tested and released.

### **Plug-and-Play Installation**

The initial setup of the OpenScape Business Attendant is wizard-based. The wizard automatically opens all required configuration dialogs.

e.g.:

- Query the terminal type

## Attendants

### OpenScape Business Attendant

- Query and check system access
- Query and check internetwork, if any
- Automatic integration of the BLF.

## 16.3.1 OpenScape Business BLF

The Busy Lamp Field OpenScape Business BLF is a separate application for displaying busy states. Optional functions include displaying and setting the presence status, and setting up the connection for the associated phone.

Main functions:

- OpenScape Business BLF is scalable and customizable
  - 10 to 350 BLF fields (user buttons), depending on the screen resolution
- Phone functions
  - Dial
  - Call answer
  - Disconnect
- Set the presence status (for own station)
- Directory (system directory)
- Call Journal

One OpenScape Business BLF license plus one UC Smart User license or UC Suite User license are required to operate each OpenScape Business BLF.

### Technical Requirements

- Standard Windows PC
- Microsoft Windows 10 / 8.1 / 8 / 7 (both 32-bit or 64-bit are possible)
- Microsoft Windows Vista (32 bit)
- Microsoft Windows Server 2015 (32 bit / 64 bit) as Microsoft Terminal Server
- Microsoft Windows Server 2012 (32 bit / 64 bit) as Microsoft Terminal Server
- Microsoft Windows Server 2008 R2 (64 bit) as Microsoft Terminal Server
- Screen with a resolution of min. 1024x768
- Video card with 16-bit color depth (min. 256 colors)
- LAN interface
- Standard mouse and keyboard
- Internet access for support or updates

## 16.3.2 Configuration Examples for OpenScape Business Attendant, OpenScape Business BLF

In the following sections you will find configuration examples for the general configuration of OpenScape Business Attendant, OpenScape Business BLF.

### 16.3.2.1 Scenario 1: OpenScape Business Attendant Connected to an OpenScape Business Single System

#### Prerequisites

- The license for OpenScape Business Attendant is present.
- Telephone with valid license
- License for UC Smart or UC Suite for presence information (optional)
- The IP address for the Web Service Interface is different for UC Smart and UC Suite. In the case of UC Smart, the WSI always runs on the communication system; for the UC Suite, by contrast, it runs on the Application Board or Application Server (see [UC Smart](#) and [UC Suite](#)). If Booster Server is in use, the IP-address of Booster Server has to be used while if OCAB is in use, the IP-address of the OCAB has to be used. Only if both components are not connected, communication system's IP must be used.

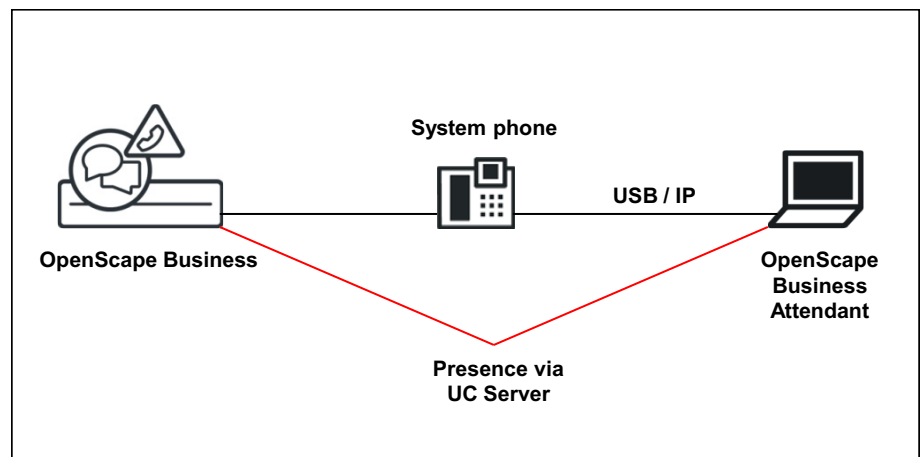

#### Step by Step

- 1) Configure a station as an attendant using the WBM or Manager E (optiPoint 500, OpenStage 30T, 40T, 60T, 80T or OpenStage 40HFA, 60HFA, 80 HFA).

---

**INFO:** SIP or CMI phones have not been released.

---

- 2) Configure the **Associated services** feature. This is needed for the OpenScape Business Attendant to enable and disable features for other stations.
- 3) Activate **Override Do Not Disturb** and disable **Call waiting rejection**.

## Attendants

### OpenScope Business Attendant

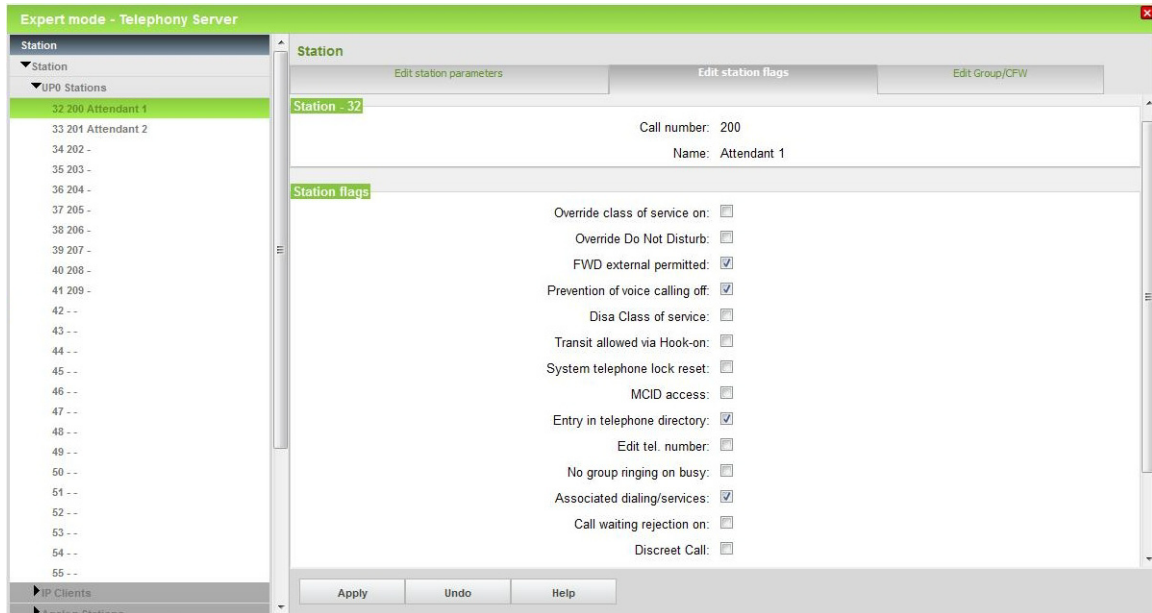

- 4) Configure the intercept criteria and Attendant codes (define the intercept options and call numbers for the Attendant Console).

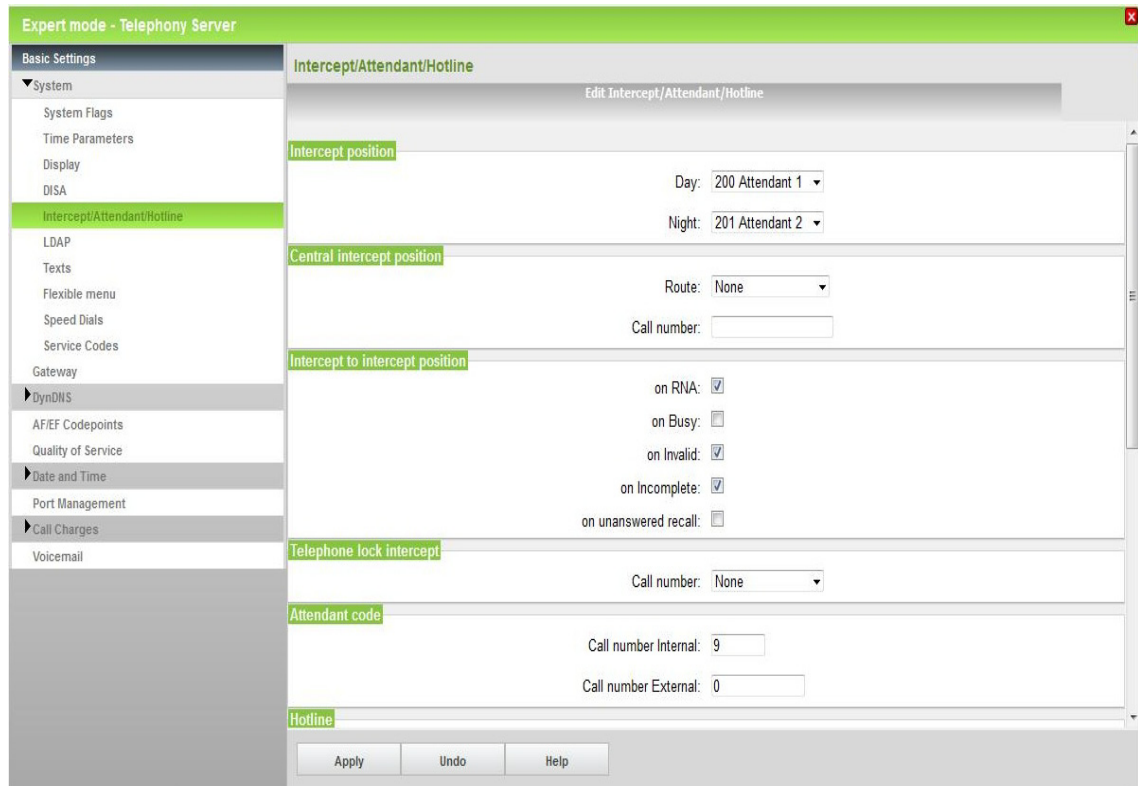

- 5) Licensing the OpenScope Business Attendant

License Management				
License information 00:1A:E8:5D:09:90				
Local User licenses				
Overview				
IP User				
TDM User				
Mobility User				
Deskshare User				
CO Trunks				
<b>System Licenses</b>				
License Profiles				
Create Profiles				
Assign Profiles				
Registration				
Activate License Online				
Activate License File				
Settings				

System Licenses				
Product Name	Feature	used licenses	available for distribution	
OpenScope Business V1	OpenScope Business V1 Xpr Compact Announcement	24	24	
OpenScope Business V1	OpenScope Business V1 Xpr Compact Conferencing	3	3	
OpenScope Business V1	OpenScope Business V1 Xpr Compact Mobility	6	6	
OpenScope Business V1	OpenScope Business V1 OpenDirectory Connector	4	4	
OpenScope Business V1	OpenScope Business V1 OpenDirectory Base	1	1	
OpenScope Business V1	OpenScope Business V1 optiClient Attendant	8	8	
OpenScope Business V1	OpenScope Business V1 Networking	1	1	
OpenScope Business V1	OpenScope Business V1 Web Collaboration	1	1	
OpenScope Business V1	OpenScope Business V1 Company Autoattendant	1	1	
OpenScope Business V1	OpenScope Business V1 Contact Center Fax	1	1	
OpenScope Business V1	OpenScope Business V1 Contact Center E-Mail	1	1	
OpenScope Business V1	OpenScope Business V1 myReports	1	1	
OpenScope Business V1	OpenScope Business V1 Gate View Cameras	8	8	

**6) Licensing the presence status (UC Smart)**

License Management				
License information				
Local User licenses				
Overview				
IP User				
<b>TDM User</b>				
Mobility User				
Deskshare User				
CO Trunks				
System Licenses				
License Profiles				
Create Profiles				
Assign Profiles				
Registration				
Activate License Online				
Activate License File				
Settings				

TDM User															
Access	Call number	Name													
<b>Remaining licenses</b>			40	49	42	100	50	100	100	1	10	100	30		
SLUC8 2-1 Master	100	Attendant 1	<input checked="" type="checkbox"/>	<input type="checkbox"/>	<input checked="" type="checkbox"/>	<input type="checkbox"/>	<input type="checkbox"/>	<input type="checkbox"/>	<input type="checkbox"/>	<input type="checkbox"/>	<input type="checkbox"/>	<input type="checkbox"/>	<input type="checkbox"/>	<input type="checkbox"/>	
SLUC8 2-2 Master	101	Attendant 2	<input checked="" type="checkbox"/>	<input type="checkbox"/>	<input checked="" type="checkbox"/>	<input type="checkbox"/>	<input type="checkbox"/>	<input type="checkbox"/>	<input type="checkbox"/>	<input type="checkbox"/>	<input type="checkbox"/>	<input type="checkbox"/>	<input type="checkbox"/>	<input type="checkbox"/>	
SLUC8 2-3 Master	102	User-102	<input checked="" type="checkbox"/>	<input type="checkbox"/>	<input checked="" type="checkbox"/>	<input type="checkbox"/>	<input type="checkbox"/>	<input type="checkbox"/>	<input type="checkbox"/>	<input type="checkbox"/>	<input type="checkbox"/>	<input type="checkbox"/>	<input type="checkbox"/>	<input type="checkbox"/>	
SLUC8 2-4 Master	103	User-103	<input checked="" type="checkbox"/>	<input type="checkbox"/>	<input checked="" type="checkbox"/>	<input type="checkbox"/>	<input type="checkbox"/>	<input type="checkbox"/>	<input type="checkbox"/>	<input type="checkbox"/>	<input type="checkbox"/>	<input type="checkbox"/>	<input type="checkbox"/>	<input type="checkbox"/>	
SLUC8 2-5 Master	104		<input checked="" type="checkbox"/>	<input type="checkbox"/>	<input checked="" type="checkbox"/>	<input type="checkbox"/>	<input type="checkbox"/>	<input type="checkbox"/>	<input type="checkbox"/>	<input type="checkbox"/>	<input type="checkbox"/>	<input type="checkbox"/>	<input type="checkbox"/>	<input type="checkbox"/>	
SLUC8 2-6 Master	105		<input checked="" type="checkbox"/>	<input type="checkbox"/>	<input checked="" type="checkbox"/>	<input type="checkbox"/>	<input type="checkbox"/>	<input type="checkbox"/>	<input type="checkbox"/>	<input type="checkbox"/>	<input type="checkbox"/>	<input type="checkbox"/>	<input type="checkbox"/>	<input type="checkbox"/>	
SLUC8 2-7 Master	106	TDM-106	<input checked="" type="checkbox"/>	<input type="checkbox"/>	<input checked="" type="checkbox"/>	<input type="checkbox"/>	<input type="checkbox"/>	<input type="checkbox"/>	<input type="checkbox"/>	<input type="checkbox"/>	<input type="checkbox"/>	<input type="checkbox"/>	<input type="checkbox"/>	<input type="checkbox"/>	
SLUC8 2-8 Master	107	TDM-107	<input checked="" type="checkbox"/>	<input type="checkbox"/>	<input checked="" type="checkbox"/>	<input type="checkbox"/>	<input type="checkbox"/>	<input type="checkbox"/>	<input type="checkbox"/>	<input type="checkbox"/>	<input type="checkbox"/>	<input type="checkbox"/>	<input type="checkbox"/>	<input type="checkbox"/>	
4SLAV 3-1	108	Ana_108	<input checked="" type="checkbox"/>	<input type="checkbox"/>	<input type="checkbox"/>	<input type="checkbox"/>	<input type="checkbox"/>	<input type="checkbox"/>	<input type="checkbox"/>	<input type="checkbox"/>	<input type="checkbox"/>	<input type="checkbox"/>	<input type="checkbox"/>	<input type="checkbox"/>	
4SLAV 3-2	109	Ana_109	<input checked="" type="checkbox"/>	<input type="checkbox"/>	<input type="checkbox"/>	<input type="checkbox"/>	<input type="checkbox"/>	<input type="checkbox"/>	<input type="checkbox"/>	<input type="checkbox"/>	<input type="checkbox"/>	<input type="checkbox"/>	<input type="checkbox"/>	<input type="checkbox"/>	
4SLAV 3-3	110	Ana_110	<input type="checkbox"/>	<input checked="" type="checkbox"/>	<input type="checkbox"/>	<input checked="" type="checkbox"/>	<input checked="" type="checkbox"/>	<input checked="" type="checkbox"/>	<input checked="" type="checkbox"/>	<input checked="" type="checkbox"/>	<input checked="" type="checkbox"/>	<input checked="" type="checkbox"/>	<input checked="" type="checkbox"/>	<input checked="" type="checkbox"/>	
4SLAV 3-4	111	Ana_111	<input type="checkbox"/>	<input checked="" type="checkbox"/>	<input type="checkbox"/>	<input checked="" type="checkbox"/>	<input checked="" type="checkbox"/>	<input checked="" type="checkbox"/>	<input checked="" type="checkbox"/>	<input checked="" type="checkbox"/>	<input checked="" type="checkbox"/>	<input checked="" type="checkbox"/>	<input checked="" type="checkbox"/>	<input checked="" type="checkbox"/>	
SLUC8 2-1 Slave			<input type="checkbox"/>	<input checked="" type="checkbox"/>	<input type="checkbox"/>	<input checked="" type="checkbox"/>	<input checked="" type="checkbox"/>	<input checked="" type="checkbox"/>	<input checked="" type="checkbox"/>	<input checked="" type="checkbox"/>	<input checked="" type="checkbox"/>	<input checked="" type="checkbox"/>	<input checked="" type="checkbox"/>	<input checked="" type="checkbox"/>	

Page 1 of 1 Items per page [10](#) [25](#) [50](#) [100](#)

Only configured users are displayed and can be licensed.

Successfully licensed  
  Not licensed  
  License demand configurable  
  License demand not configurable  
 Unsaved license release  
  Unsaved license demand release  
  Unsaved license demand

**7) Or: Licensing the presence status (UC Suite)**

**Attendants**  
OpenScape Business Attendant

Access	Call number	Name	Remaining licenses	40	49	44	100	48	100	100	1	10	100	30
SLUC8 2-1 Master	100	Attendant 1	<input checked="" type="checkbox"/>	<input type="checkbox"/>	<input type="checkbox"/>	<input type="checkbox"/>	<input checked="" type="checkbox"/>	<input type="checkbox"/>	<input type="checkbox"/>	<input type="checkbox"/>	<input type="checkbox"/>	<input type="checkbox"/>	<input type="checkbox"/>	<input type="checkbox"/>
SLUC8 2-2 Master	101	Attendant 2	<input checked="" type="checkbox"/>	<input type="checkbox"/>	<input type="checkbox"/>	<input type="checkbox"/>	<input type="checkbox"/>	<input type="checkbox"/>	<input type="checkbox"/>	<input type="checkbox"/>	<input type="checkbox"/>	<input type="checkbox"/>	<input type="checkbox"/>	<input type="checkbox"/>
SLUC8 2-3 Master	102	User-102	<input checked="" type="checkbox"/>	<input type="checkbox"/>	<input checked="" type="checkbox"/>	<input type="checkbox"/>	<input type="checkbox"/>	<input type="checkbox"/>	<input type="checkbox"/>	<input type="checkbox"/>	<input type="checkbox"/>	<input type="checkbox"/>	<input type="checkbox"/>	<input type="checkbox"/>
SLUC8 2-4 Master	103	User-103	<input checked="" type="checkbox"/>	<input type="checkbox"/>	<input type="checkbox"/>	<input type="checkbox"/>	<input type="checkbox"/>	<input type="checkbox"/>	<input type="checkbox"/>	<input type="checkbox"/>	<input type="checkbox"/>	<input type="checkbox"/>	<input type="checkbox"/>	<input type="checkbox"/>
SLUC8 2-5 Master	104		<input checked="" type="checkbox"/>	<input type="checkbox"/>	<input checked="" type="checkbox"/>	<input type="checkbox"/>	<input type="checkbox"/>	<input type="checkbox"/>	<input type="checkbox"/>	<input type="checkbox"/>	<input type="checkbox"/>	<input type="checkbox"/>	<input type="checkbox"/>	<input type="checkbox"/>
SLUC8 2-6 Master	105		<input checked="" type="checkbox"/>	<input type="checkbox"/>	<input checked="" type="checkbox"/>	<input type="checkbox"/>	<input type="checkbox"/>	<input type="checkbox"/>	<input type="checkbox"/>	<input type="checkbox"/>	<input type="checkbox"/>	<input type="checkbox"/>	<input type="checkbox"/>	<input type="checkbox"/>
SLUC8 2-7 Master	106	TDM-106	<input checked="" type="checkbox"/>	<input type="checkbox"/>	<input checked="" type="checkbox"/>	<input type="checkbox"/>	<input type="checkbox"/>	<input type="checkbox"/>	<input type="checkbox"/>	<input type="checkbox"/>	<input type="checkbox"/>	<input type="checkbox"/>	<input type="checkbox"/>	<input type="checkbox"/>
SLUC8 2-8 Master	107	TDM-107	<input checked="" type="checkbox"/>	<input type="checkbox"/>	<input checked="" type="checkbox"/>	<input type="checkbox"/>	<input type="checkbox"/>	<input type="checkbox"/>	<input type="checkbox"/>	<input type="checkbox"/>	<input type="checkbox"/>	<input type="checkbox"/>	<input type="checkbox"/>	<input type="checkbox"/>
4SLAV 3-1	108	Ana_108	<input checked="" type="checkbox"/>	<input type="checkbox"/>	<input type="checkbox"/>	<input type="checkbox"/>	<input type="checkbox"/>	<input type="checkbox"/>	<input type="checkbox"/>	<input type="checkbox"/>	<input type="checkbox"/>	<input type="checkbox"/>	<input type="checkbox"/>	<input type="checkbox"/>
4SLAV 3-2	109	Ana_109	<input checked="" type="checkbox"/>	<input type="checkbox"/>	<input type="checkbox"/>	<input type="checkbox"/>	<input type="checkbox"/>	<input type="checkbox"/>	<input type="checkbox"/>	<input type="checkbox"/>	<input type="checkbox"/>	<input type="checkbox"/>	<input type="checkbox"/>	<input type="checkbox"/>
4SLAV 3-3	110	Ana_110	<input type="checkbox"/>	<input checked="" type="checkbox"/>	<input checked="" type="checkbox"/>	<input checked="" type="checkbox"/>	<input checked="" type="checkbox"/>	<input checked="" type="checkbox"/>	<input checked="" type="checkbox"/>	<input checked="" type="checkbox"/>	<input checked="" type="checkbox"/>	<input checked="" type="checkbox"/>	<input checked="" type="checkbox"/>	<input checked="" type="checkbox"/>
4SLAV 3-4	111	Ana_111	<input type="checkbox"/>	<input checked="" type="checkbox"/>	<input checked="" type="checkbox"/>	<input checked="" type="checkbox"/>	<input checked="" type="checkbox"/>	<input checked="" type="checkbox"/>	<input checked="" type="checkbox"/>	<input checked="" type="checkbox"/>	<input checked="" type="checkbox"/>	<input checked="" type="checkbox"/>	<input checked="" type="checkbox"/>	<input checked="" type="checkbox"/>
SLUC8 2-1 Slave			<input type="checkbox"/>	<input checked="" type="checkbox"/>	<input checked="" type="checkbox"/>	<input checked="" type="checkbox"/>	<input checked="" type="checkbox"/>	<input checked="" type="checkbox"/>	<input checked="" type="checkbox"/>	<input checked="" type="checkbox"/>	<input checked="" type="checkbox"/>	<input checked="" type="checkbox"/>	<input checked="" type="checkbox"/>	<input checked="" type="checkbox"/>

8) Optional: when setting up an Attendant as an IP station, a password for the user account must be set up at the telephone.



- 9) Install the USB driver
  - USB - COM driver (CallBridge) for optiPoint 500, OpenStage 30T and OpenStage 40T
  - USB - RNDIS driver for OpenStage 60T and OpenStage 80T
- 10) Install OpenScape Business Attendant via the installation routine (accept the license agreement, specify the storage location and the language of the OpenScape Business Attendant).

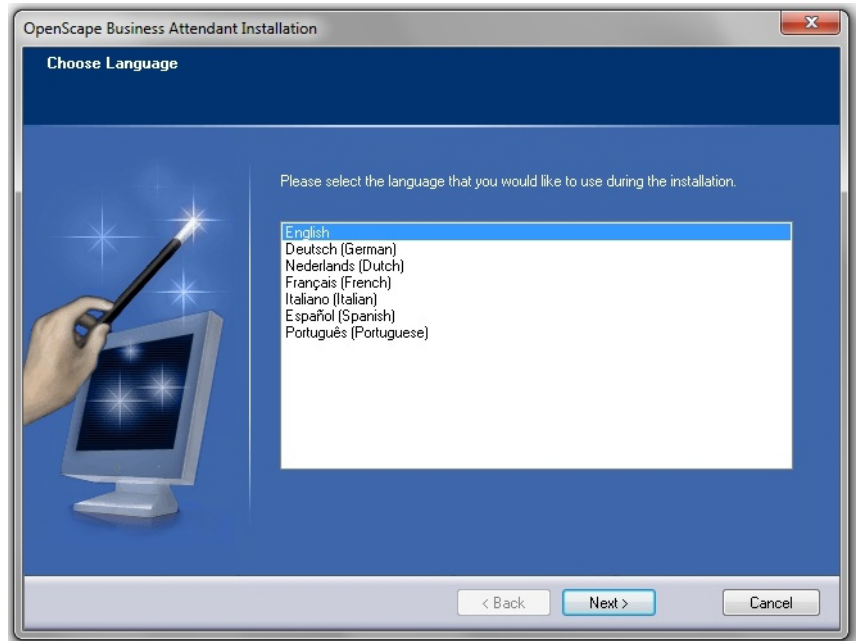

After the installation and the initial startup of the program, the configuration wizard starts automatically and requests the following settings:

Type of telephone

Is the presence function to be used?

Configuration for access in the Attendant:

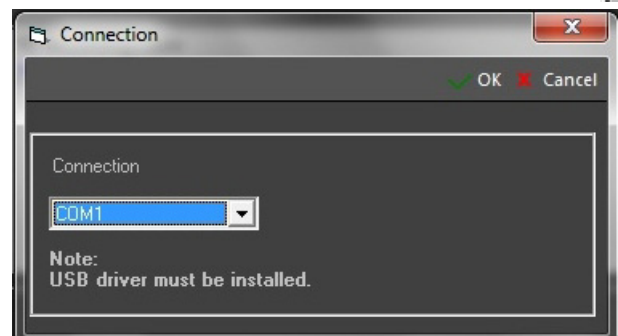
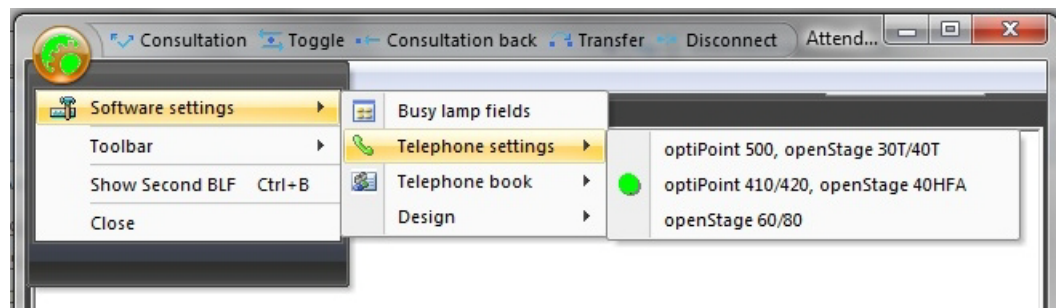

After logging into the communication system successfully, it is possible to fill the BLF automatically.

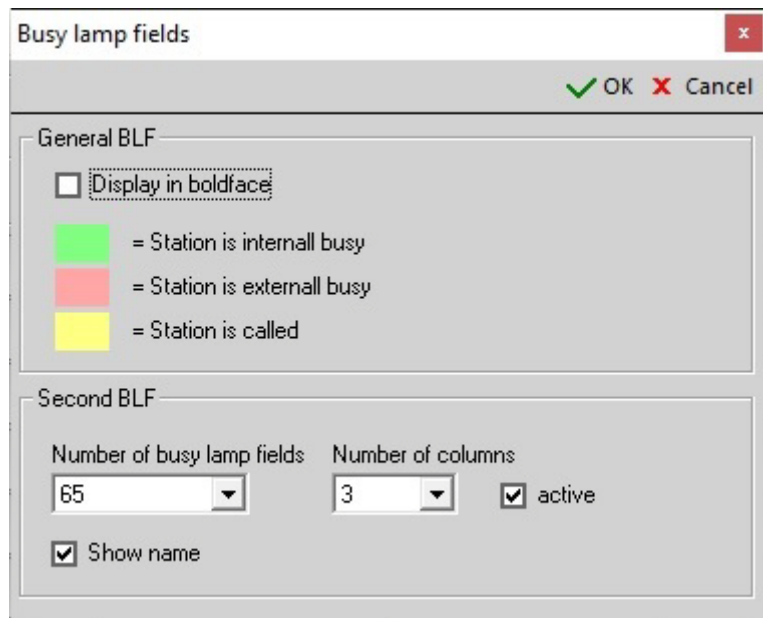

---

**INFO:** Assign or check the security settings (http or https) in the WBM.

---



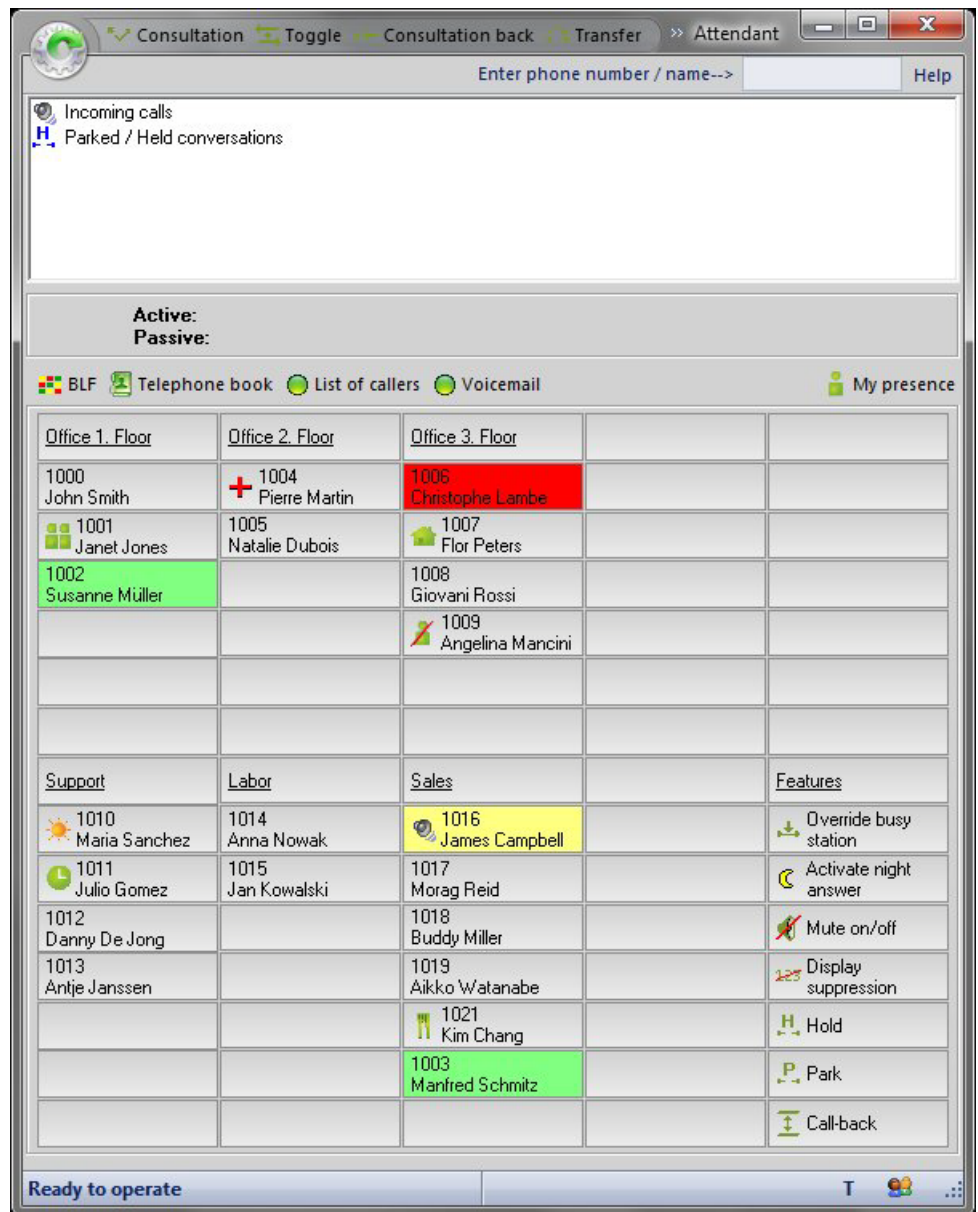

### 16.3.2.2 Scenario 2: Two or More OpenScape Business Attendants Connected to an OpenScape Business Single System

#### Prerequisites

- The following prerequisites are required in addition to those for scenario 1:
- Sufficient licenses for UC Smart or UC Suite for presence information (optional)
- Group configuration

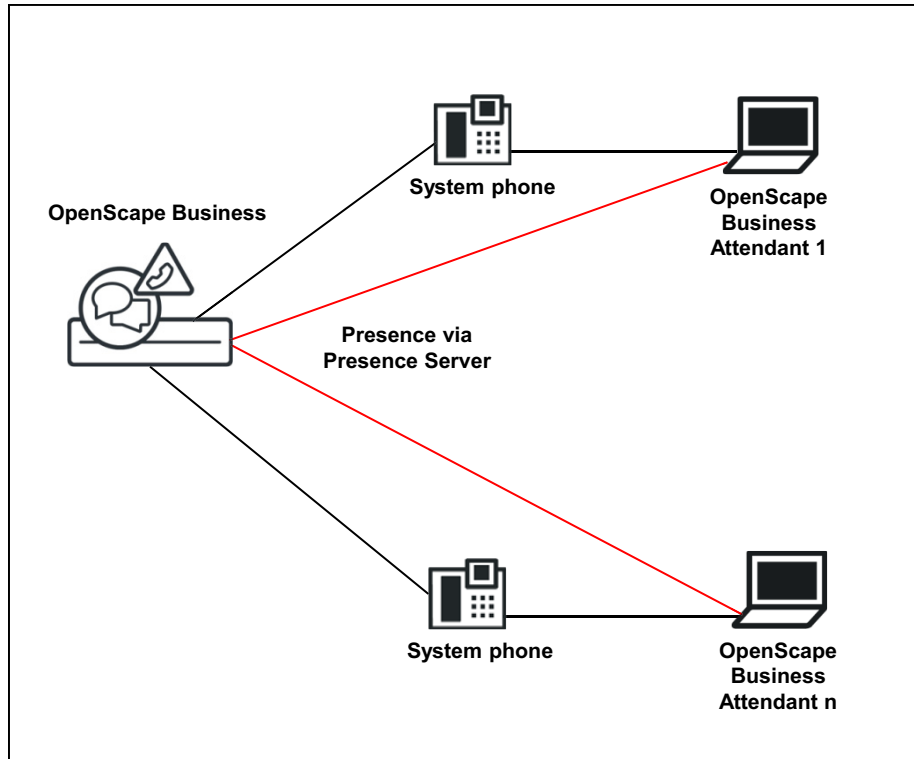

**Step by Step**

- 1) Set up as a station as an Attendant via the WBM (see Configuration Example 1).
- 2) Define a group; hunt groups (linear and cyclic) and call groups are supported.

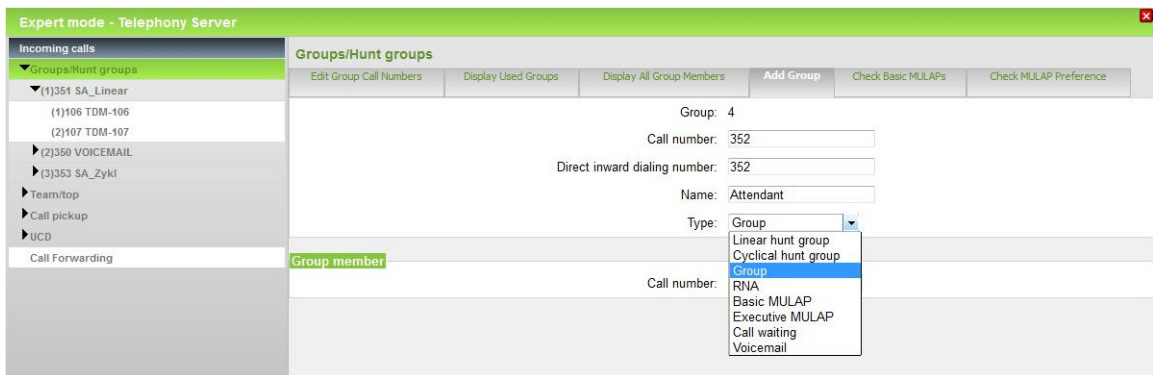

- 3) Assign the attendants (the corresponding subscribers) to the group.

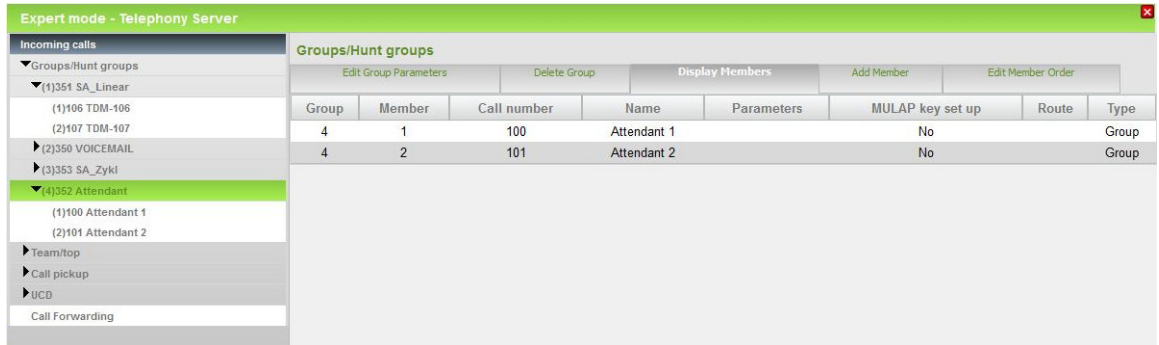

---

**INFO:** Configure the intercept criteria and Attendant codes (define the intercept options and call numbers for the Attendant Console). In these cases, the intercept position is the group phone number.

---

### 16.3.2.3 Scenario 3: OpenScape Business Network with Individual OpenScape Business Attendants (Network-wide BLF and Presence Status via WSI)

#### Prerequisites

- License for UC Smart for presence information (optional)
- Multiple OpenScape Business Attendants can be used in UC-Smart networks only. The WSI (Presence Server of OpenScape Business) provides netwide Hook states and Presence information. UC-Suite networks need myAttendant for netwide functionality.

### 16.3.2.4 Scenario 4: OpenScape Business Network with central OpenScape Business Attendant (Network-wide BLF and Presence Status via WSI)

#### Prerequisites

- License for UC Smart for presence information (optional)
- Multiple OpenScape Business Attendants can be used in UC-Smart networks only. The WSI (presence server of OpenScape Business) provides netwide Hook states and Presence information. UC-Suite networks need myAttendant for netwide functionality.
- Central intercept position (in the node in which no OpenScape Business Attendant is set up)

**Step by Step**

- 1) Set up the OpenScape Business Attendant in accordance with configuration example 1.
- 2) Enter the central intercept position in the node (where no OpenScape Business Attendant has been set up).

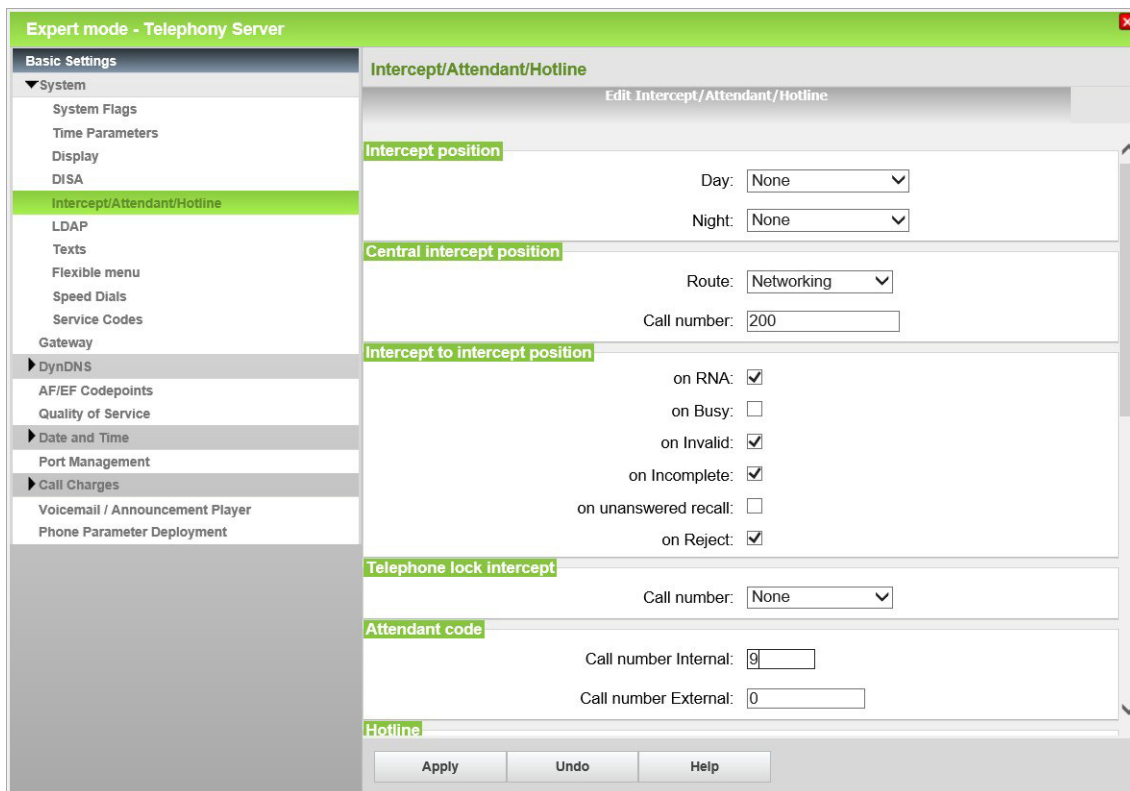

**16.3.2.5 Scenario 5: OpenScape Business BLF Connected to an OpenScape Business Single System**

**Prerequisites**

- One OpenScape Business BLF license is available for each station
- The phones are already assigned
- One UC Smart or UC Suite license is available for each station

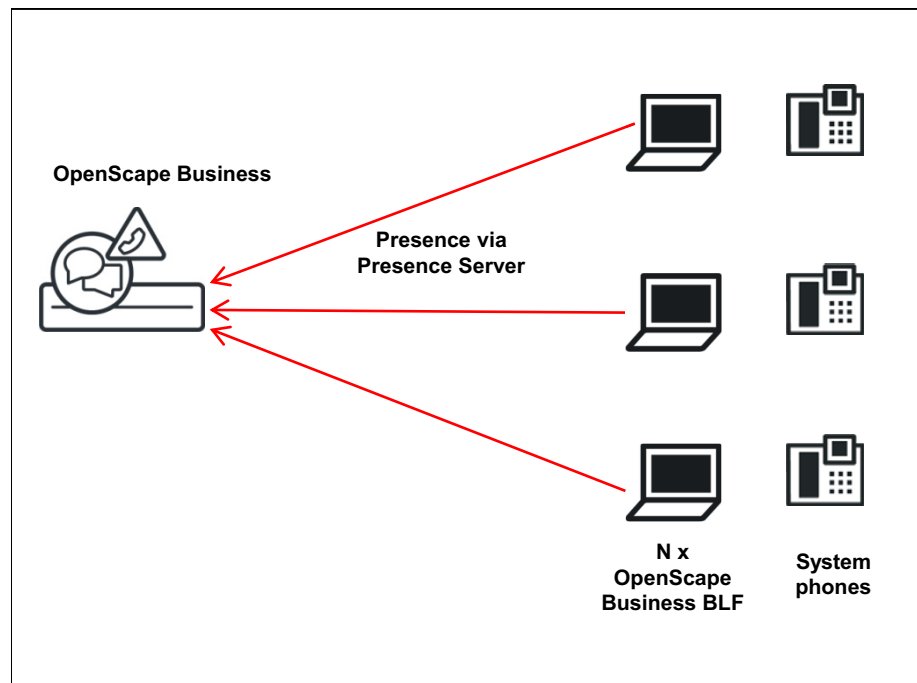

**Step by Step**

- 1) Configure the telephones via WBM
- 2) Configure the presence server via WBM
- 3) Install and start OpenScape Business BLF
- 4) The (optional) automatic assignment of the OpenScape Business BLF occur after the initial startup.

## Attendants

### OpenScope Business Attendant

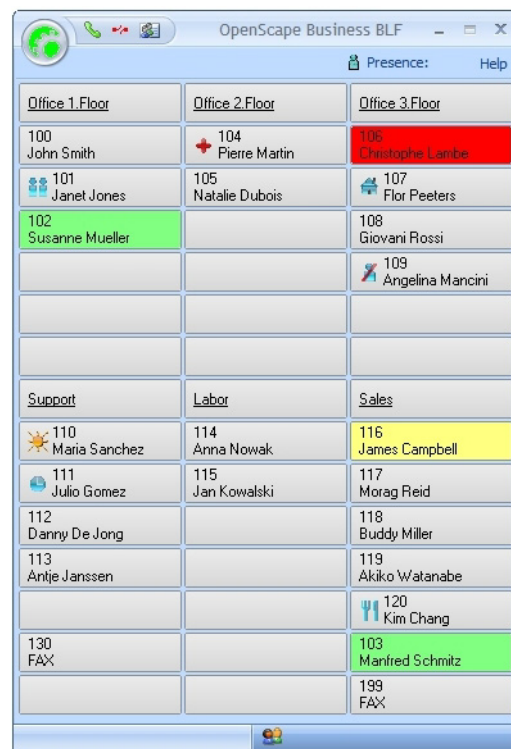

### 16.3.2.6 Scenario 6: OpenScope Business BLF Connected to an OpenScope Business Internetwork (BLF and Presence Status via WSI)

#### Prerequisites

- One OpenScope Business BLF license is available for each subscriber
- The phones are already assigned
- A UC Smart license is available for each subscriber
- OpenScope Business BLF can be used in UC-Smart networks, not in UC Suite networks. The WSI (Presence server of OpenScope Business) provides worldwide Hook states and Presence information.

#### Step by Step

- 1) Configure the telephones via WBM
- 2) Install and start OpenScope Business BLF
- 3) The connection to the WSI and the manual assignment of the BLF occur after the initial startup. In this case, the BLF can be assigned for network-wide stations.

## 16.4 myAttendant

A wide range of Attendant functions are available to you via myAttendant. Subscribers can be easily managed here via user buttons. In addition, messaging functions (voicemail, faxes, instant messages, SMS, and e-mails) are available via the Message Center.

A maximum of 20 myAttendants can be connected per communication system (per node). The maximum configuration of the internetwork is equal to the total capacities of the networked communication systems. The presence and phone status are shown for all subscribers in the network. The Message Center of myAttendant shows the subscribers of the own communication system.

### Main Attendant Functions

- Manage waiting or accepted calls
- The data of the active call is displayed
- Parked calls on hold are displayed
- Caller list
- Journal for open, scheduled, internal, external, answered, missed and outbound calls
- Directory (phonebook) application
  - LDAP (e.g., ODS)
  - Personal directory / Outlook contacts
  - Internal directory, for all interconnected stations in the network.
- Busy Lamp Field status of all internal subscribers of the own system as well as all stations of the network
  - Phone status: Free, Busy, Called, Forwarded, Do Not Disturb
  - Presence status (Office, CallMe, Meeting, Sick, Break, Out of the Office, Vacation, Lunch, Gone Home (netwide))
- There are three interface styles to choose from.
- A maximum of 20 myAttendants can be connected per communication system (up to 20 licenses per OpenScape Business X3/X5/X8 and OpenScape Business S). The licensing of myAttendant occurs via the WBM.

### Technical Requirements (see the Sales Information for Details)

- Standard Windows PC
- Microsoft Windows 10 / 8.1 / 8 / 7 (both 32-bit or 64-bit are possible)
- Microsoft Windows Vista (32 bit)
- Terminal server usage possible

### Additional Software

- Latest Oracle Java version (see **Service Center > Software**)

### Supported Phones

- Openstage 40/60/80 HFA

- OpenScape Desk Phone IP 35G/55G HFA
- OpenScape Desk Phone IP 35G Eco HFA
- OpenScape Desk Phone CP 200/205/400/600 HFA
- SIP phones with RFC 3725 support, e.g., OpenScape Desk Phone IP 35G/55G SIP, OpenScape Desk Phone CP 200/205/400/600 SIP
- OpenStage 30T/40T/60T/80T

Simple plug and play installation; the first steps for the installation are sent to the user by the system (if his or her e-mail address has been configured).

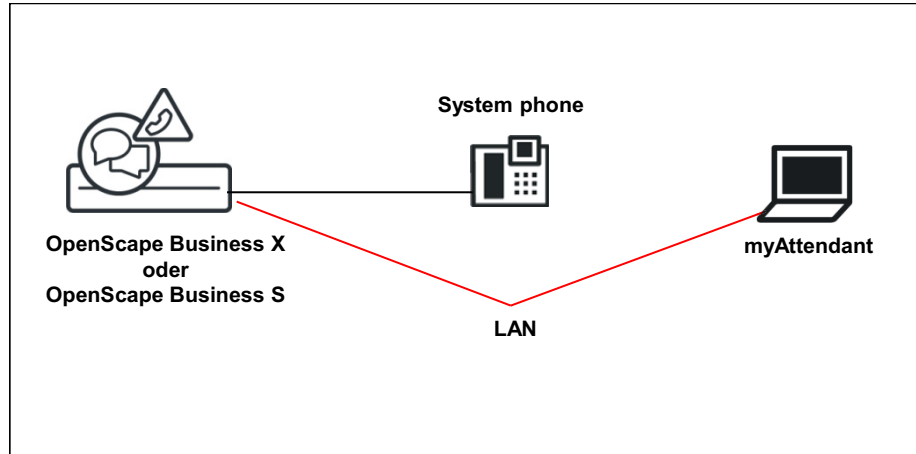

## 16.4.1 Subscriber Management

Subscriber management is performed in myAttendant via user buttons, the internal directory, and the external directory.

### User Buttons

The user buttons are located on the **Default** tab and are a part of the main window of myAttendant.

There are 90 user buttons available on a user buttons tab. The user buttons are sorted in alphabetical order by default. Internal and external subscribers (users) can be assigned to user buttons.

You can configure multiple tabs for user buttons and select the names for these user buttons freely.

## 16.4.2 Message Center

All voicemails, faxes, instant messages as well as SMS messages and e-mails are recorded and managed via the **Message Center** of myAttendant.

Messages can also be managed for other subscribers, provided these subscribers have granted the appropriate permission for this.



The Subscriber List window, contains a list of all communication system subscribers with their presence/absence status. Your own status is displayed first in a drop-down message overview. The other subscribers follow in alphabetical order.

Depending on what is selected in the message overview, message details are displayed, including a table of message-specific information that can be selected for further processing.

The various message types can be processed as follows:

- **Voice Messages (i.e., voicemails)** can be played back, deleted and forwarded,
- **LAN Messages** can be read, edited and deleted,
- **Fax messages** can be forwarded.

#### **LAN Messages**

LAN messages can be created only by myAttendant users. They serve as a kind of "bulletin board" for the subscriber, on which he or she enters notes (about individual subscribers). These messages can be viewed, edited or deleted, but cannot be sent to other subscribers.

### **16.4.3 Scenario 1: How to Configure a myAttendant connected to an OpenScape Business Single System**

#### ***Prerequisites***

- The license for myAttendant is present.
- Telephones with a valid license
- The Application Server or Application Board is available
- UC Suite has been enabled via the Basic Installation wizard

#### ***Step by Step***

- 1) Configure the Attendant Console using the WBM
- 2) Disable **Call waiting rejection** in **Expert mode**, under **Stations>IP Clients>System Clients>Stations>Edit Station Flags**.
- 3) Enable the feature **Immediately camp on for attendant calls** in **Expert Mode** under **Telephony Server>Basic Settings>System>Intercept>Attendant>Hotline**.
- 4) Check or change the intercept criteria and Attendant codes (define the intercept options and call numbers for the Attendant Console).
- 5) Licensing of myAttendant
- 6) After logging into the communication system successfully, it is possible to fill the BLF automatically. This can be configured in myAttendant in the personal settings under Group Setup.

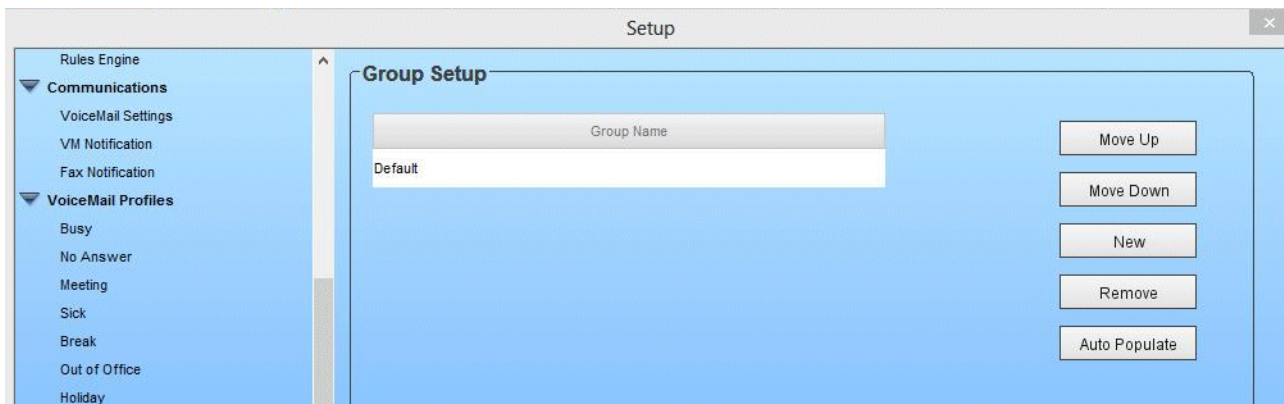

## 16.4.4 Scenario 2: How to Configure Two or More myAttendants connected to an OpenScape Business Single System

Scenario 2 is based on scenario 1 and is configured additively.

### Prerequisites

- Sufficient licenses for myAttendant
- Telephone with a valid license

### Step by Step

- 1) Configure a group (consisting only of Attendant Consoles) in the WBM under **Setup > User Telephony > Group Call**.

A screenshot of a wizard window titled "Setup - Wizards - User Telephony - Group Call / Hunt Group". The main heading is "Add Call Group". The form contains the following fields:

- Call number of the group: 360
- Direct inward dialing number: 360
- Name of the group: Attendant 1
- Type: Group (dropdown menu)
- Tel. directory:

Below this is a section titled "Group member" with a field: "Call number of the subscriber to be added to the group: No entry (dropdown menu)".

- 2) Select this group when configuring the OpenStage Attendant Console phones.

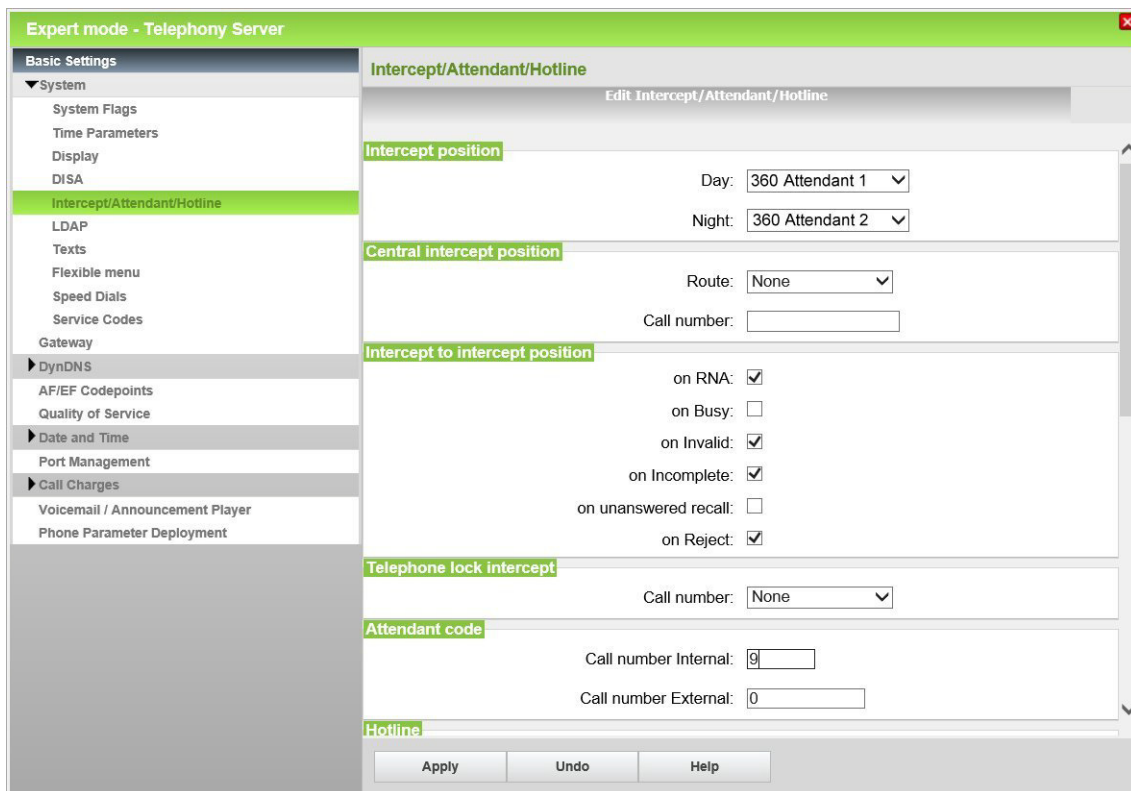

## 16.4.5 Scenario 3: How to Set Up an OpenScope Business Network with a Central myAttendant

Scenario 3 builds on scenarios 1 and 2 and is set up additively. Node 1 is linked to node 2. The central Attendant Console is in node 2.

### Prerequisites

- Sufficient licenses for myAttendant are available
- Licenses are available for networking
- Telephone with a valid license
- LCR is configured

### Step by Step

- 1) Set up a central intercept position in node 1. The central intercept position must be created in a node in which NO Attendant Console is set up.

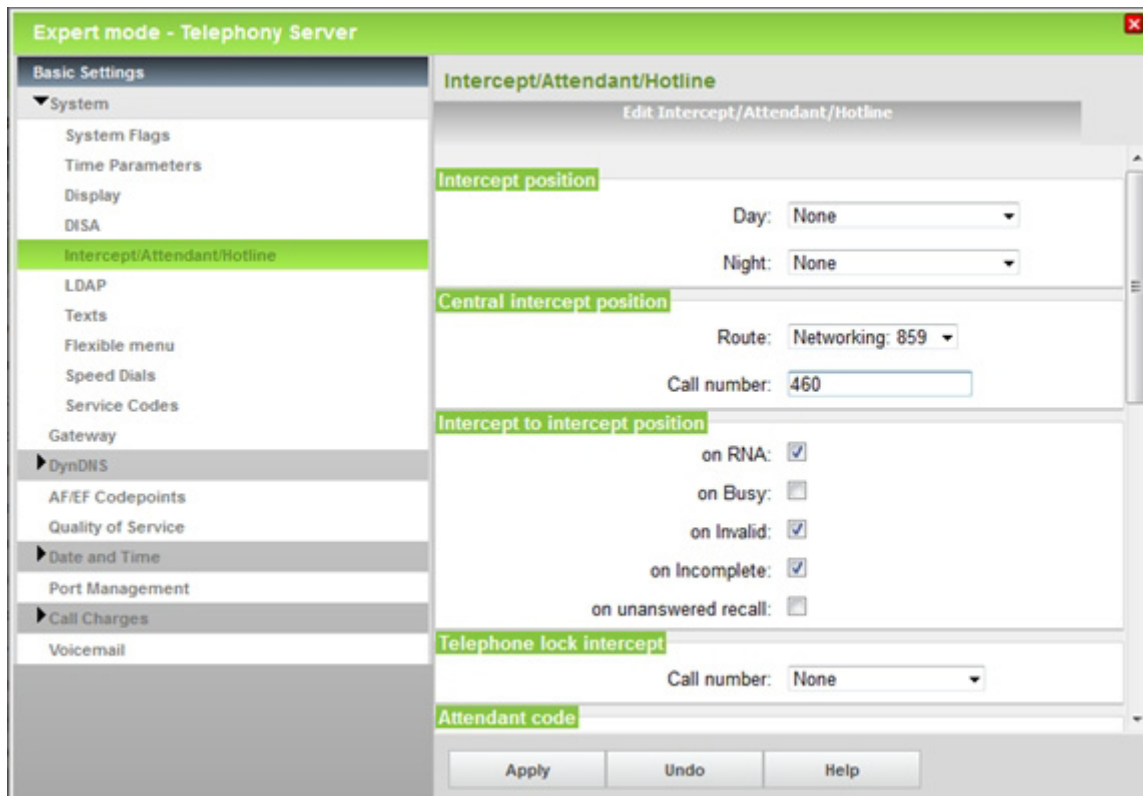

- 2) Set up the Attendant Console for system 2 (as described in Scenario 2).
- 3) Install myAttendant with the user data from node 2.

## 16.5 Intercept Position

The communication system diverts external calls that cannot be assigned to a station or answered to a set intercept position to ensure that no calls are lost. As an administrator, you can configure the intercept criteria.

The intercept position can be an individual station, a group or an announcement device:

- Intercept position (Attendant Console)
- Stations
- Hunt group
- Group call
- External announcement device

A UCD group may not be selected as an intercept position.

If an intercept position is configured in the system, intercepted calls are forwarded to this intercept position. If no intercept position is configured, intercepted calls are signaled at the first IP station.

If an internal station is set up as an intercept position, the default key assignment is assigned to it automatically. In addition, the intercept position can be authorized for the Override feature.

As an administrator, you can assign one (two-digit) attendant code each to the intercept position for internal and external, under which the intercept position can be directly reached.

The intercept applies system-wide, i.e., identically for all subscribers in tenant systems. See also "Central Intercept Position in the Internetwork" in the section on Networking.

### **Intercept criteria**

As an administrator, you can specify in which situations the Intercept feature is used via intercept criteria. The following intercept criteria are possible:

- **On RNA (ring no answer)**  
The call follows the entries in the call management (e.g., for a configured call forwarding). If no subscriber accepts the call, it is routed to the intercept position.
- **On busy, if no additional forwarding is possible.**  
The system first checks if call waiting is possible. If call waiting is not possible, the call follows the entries in Call Management (e.g., the call forwarding instruction configured). If no subscriber accepts the call, it is routed to the intercept position. Intercept on busy is only performed for first calls, not for forwarded or outgoing connections. A recall of an external station is not immediately intercepted when the destination station is busy; instead, call waiting is activated.
- **On Invalid (misdialing)**  
If the dialed station number is not configured or is inactive.
- **On Incomplete**  
If the Dialed station number is too short. Incomplete dialing is not evaluated if a central intercept position is used.
- **On unanswered recall**  
If an external call is not answered following an unscreened transfer (transfer before answer) and if the automatic recall to the original destination is also not answered, then an intercept is initiated after a preset time.
- **On rejection**  
If the call was rejected by an internal subscriber, the call follows the entries in the call management (e.g., for a configured call forwarding). If no subscriber accepts the call, it is routed to the intercept position.
- **On missing phone number**  
As for On Invalid.
- **On chained call forwarding**  
If a forwarded call encounters another forwarding instruction at the call forwarding destination, and the number of chained forwarding instructions allowed is exceeded, an intercept occurs. The number of chained forwarding

instructions depends on the entries in the call forwarding. A maximum of 3 are allowed.

- On lock code  
If a subscriber at a telephone with an activated lock code dials a seizure code, an intercept occurs. A separate intercept is defined by the administrator for this purpose.
- On announcement (only with UC Suite)  
If a subscriber dials the (two-digit) attendant code while listening to a voicemail announcement or the AutoAttendant, an intercept occurs. A separate intercept is defined by the administrator for this purpose.

**Dependencies**

Topic	Dependency
Data calls	Data calls are disconnected, not intercepted.
Hunt group	Intercepts cannot extend beyond a hunt group; the call is forwarded to the first hunt group station and remains in the hunt group.
Default key assignment	The default key assignment has also the <b>View number of calls</b> key. This can be assigned to only 6 telephones. If the limit has been reached, no more default key assignments are made. The assigned default keys are not canceled when a device is no longer defined as an intercept position.
S <sub>0</sub> trunks	On S <sub>0</sub> lines, an evaluation takes place only when no day/night intercept position has been set up.
Night service	In order to reach the same destination from both the DID trunks and the MSI trunks while the Night service is active, the entry for Night Station number under Intercept > Attendant must be identical to the <b>Night Number</b> in <b>Ringin assignment per Line</b> .

## 16.5.1 How to Configure the Intercept Position and Intercept Criteria

The **Attendant Console** wizard can be used to configure the phone numbers for the Intercept position as well as the intercept criteria.

**Prerequisites**

- You are logged on to the WBM with the **Advanced** profile.

**Step by Step**

- 1) In the navigation bar, click on **Setup**.
- 2) In the navigation tree, click **Wizards > User Telephony**.
- 3) Click on **Edit** to start the **Attendant Console** wizard.

- 4) Enter the desired call numbers for the Intercept position in the **Attendant Console** and **Attendant code** (two-digit) areas.
- 5) Define the desired values in the **Intercept criteria** area.
- 6) Click on **OK & Next** followed by **Finish**.

## 16.5.2 How to Configure the Central Intercept Position

### *Prerequisites*

- You are logged into the WBM with the **Expert** profile.

### *Step by Step*

- 1) In the navigation bar, click on **Expert Mode**.
- 2) Click **Telephony > Basic Settings** in the navigation tree.
- 3) Click **Basic Settings > System > Intercept/Attendant/Hotline** in the menu tree.
- 4) Select the desired entry from the **Route** drop-down list in the **Central intercept position** area.
- 5) Enter the desired **Call number** in the **Central intercept position** area for **Day** and **Night**.
- 6) Click on **Apply** followed by **OK**.

## 16.5.3 How to Configure the Telephone Lock Intercept

### *Prerequisites*

- You are logged into the WBM with the **Expert** profile.

### *Step by Step*

- 1) In the navigation bar, click on **Expert Mode**.
- 2) Click **Telephony > Basic Settings** in the navigation tree.
- 3) Click **Basic Settings > System > Intercept/Attendant/Hotline** in the menu tree.
- 4) Select the desired item in the **Telephone lock intercept** area from the **Station Number** field.
- 5) Click on **Apply** followed by **OK**.

## 16.5.4 How to Configure the Intercept Announcement

### *Prerequisites*

- You are logged into the WBM with the **Expert** profile.

### *Step by Step*

- 1) In the navigation bar, click on **Expert Mode**.
- 2) In the navigation tree, click on **Applications > OpenScape Business UC Suite**.
- 3) Click **Servers** in the menu tree.
- 4) Click on the **General Settings** tab.
- 5) Enter the call number for the Intercept position in the **Target Number** field of the **Call number of intercept position** area.
- 6) Click **Save** and close the window.



## 17 Multimedia Contact Center

The Contact Center is a powerful solution for the optimal distribution and handling of incoming calls, faxes and e-mails. Intelligent, skills-based routing ensures that callers are always connected to the most qualified agent, regardless of the contact medium. A number of convenient functions for handling and wrapping up calls, faxes and e-mails are offered to the Contact Center agents via the myAgent application. myReports provides a number of report templates for analyzing the Contact Center operations.

The Multimedia Contact Center is fully integrated in the UC Suite software. It includes all required software components. The Contact Center functions themselves are released through licenses.

The Contact Center uses the resources of the communication system such as queues for incoming calls and unified communications functions to record and play back announcements.

The central software component of the Contact Center controls all routing functions for incoming calls, faxes, and e-mails and also controls the LAN-connected PC workplaces of agents and wallboard displays.

On the PC workplaces of agents, the myAgent application is installed. The myReports application can be optionally installed to generate and send reports. The required software can be downloaded directly from the download area of the communication system and installed on the client PC.

The WBM is used to set up the Contact Center basic functions, schedules, distribution rules as well as the agents. The settings for the daily operation of the Contact Center such as the assignment of agents to queues, for example, can also be made directly via myAgent.

If the Contact Center is unavailable due to problems (such as a system crash, dropped connection, etc.), a fallback solution can be implemented via the UCD feature of the communication system. Distribution rules for emergencies must be taken into account when setting up UCD groups within the framework of the initial setup of the Contact Center.

---

**INFO:** Information on the UC Suite and the unified communications features can be found in the UC Suite chapter.

---

### 17.1 Contact Center Clients

A number of convenient functions for handling and wrapping up calls, faxes and e-mails are offered to the Contact Center agents via the myAgent application. The myReports application can be used to generate reports on the calls, queues, agents, performance, GOS (Grade of Service) and wrapup codes of the Contact Center. More than 100 predefined report templates are available.

## 17.1.1 myAgent

Convenient functions for handling and wrapping up calls, faxes and e-mails are available to all agents via myAgent.

myAgent provides the following features:

- Processing of
  - Make Call
  - Faxes
  - E-mails
- Callback function for agents
- Displaying and changing the agent status
- Displaying and changing the presence status of internal subscribers of the communication system
- Real-time presentation of queues
- Recording of calls, if activated in the communication system
- Request for assistance through
  - Silent monitoring of calls (depending on country)
  - Overriding calls
  - Instant Messaging
- Integration of the internal directory, external directory and the external offline directory (LDAP) for searches by name
- Creation of reports based on predefined report templates

Depending on the authorization level assigned to an agent, either a set of standard functions (agent) or advanced functions (Supervisor or Administrator) are available to the agents in myAgent (see *Administrator Documentation, Multimedia Contact Center*).

The assignment of agents to queues occurs using the myAgent application. Only an agent with the authorization level of a Supervisor or an Administrator can make this assignment. The following properties, which affect the distribution of calls, faxes and e-mails in a queue, can be assigned here to the agents (agent assignment (binding)):

- **Primary Agent or Overflow Agent**  
Calls are distributed uniformly to primary agents. An overflow agent receives a call only when the number of calls exceeds a defined number or when a call has exceeded a specified waiting period.
- **Overflow after seconds in queue**  
Calls that exceed this waiting period and received by an overflow agent.
- **Overflow after calls in queue**  
Calls that exceed the maximum number are received by an overflow agent.
- **Skill Level**  
Skill levels control the distribution of calls to agents in call queues. Agents with higher skill levels are given precedence when calls are distributed. In cases where all agents have the same skill level the longest idle agent receives the call.

- **Enable agent callback**  
Agent callback enables a caller in the queue to leave a voicemail for agents. As soon as an appropriate agent becomes free, that agent receives a call, hears the voicemail left by the caller, and can then call back that caller.
- **Wrapup time**  
The wrapup time enables agents to finish any tasks, e.g., administrative tasks, that may be required after completing a call and before receiving the next call.

The **agent binding list** shows agents with the authorization level of a Supervisor or Administrator which agents are assigned to which queues. Agents with the agent authorization level can only see the queues to which they are assigned.

## 17.1.2 Prerequisites for myAgent

In order to use myAgent, the client PC of the subscriber must be equipped with the appropriate hardware and software configurations.

---

**INFO:** Please make sure that you refer to the current notes in the `ReadMe first` file, which is located in the storage directory of the install files.

---

### Telephones

myAgent can be used in combination with the following telephones:

- OpenStage HFA
- OpenScape Desk Phone IP 35G/55G HFA
- OpenScape Desk Phone IP 35G Eco HFA
- OpenScape Desk Phone CP 200/205/400/600 HFA
- OpenStage T
- OpenScape Personal Edition HFA
- OpenStage S5/M3/SL4 (OpenScape Business Cordless)

Older devices (such as optiPoint 410/420/500 and Gigaset M2/SL3/S4) are supported. Optiset E devices cannot be operated. myAgent cannot be used with SIP stations, Mobility stations, virtual stations, groups or MULAP stations. Details on the tested and released telephones can be found in the Release Notice.

### Operating Systems

myAgent can be used in combination with the following operating systems:

- Microsoft Windows 10 / 8.1 / 8 / 7 (both 32-bit or 64-bit are possible)
- Microsoft Windows Vista (32 bit)

---

**INFO:** The used operating system always requires the latest version of all available updates (Service Packs and patches).

---

Support for myReports for Microsoft Windows XP and Microsoft Windows Server 2003 will end at the same time as the end of support for these products by Microsoft. The product will still be supported, but will no longer be tested in detail.

#### **Additional Software**

- Latest Oracle Java version (see **Service Center > Software**)
- Adobe Reader 9 or later (for reports in PDF format)

#### **Minimum Hardware Requirements**

- 2 GHz CPU
- RAM: 2 GB
- 100 Mbps LAN
- XGA (1024x768) screen resolution, myPortal for Outlook: SVGA (800x600) screen resolution

#### **Microsoft Terminal Server, Citrix XenApp Server**

myAgent can be used in Microsoft Terminal Server and Citrix Server environments under the following preconditions:

---

**INFO:** Terminal Server and Citrix Server environments, including hosted services and virtual environments are the responsibility of the customer.

---

---

**INFO:** Citrix server environments can decode some regional characters (e.g., German umlauts) correctly.

---

Operating systems:

- Microsoft Windows Server 2015 (32 bit / 64 bit) as Microsoft Terminal Server
- Microsoft Windows Server 2012 (32 bit / 64 bit) as Microsoft Terminal Server
- Microsoft Windows Server 2008 R2 (64 bit) as Microsoft Terminal Server
- Microsoft Windows Server 2008 R2 (64 bit) with Citrix XenApp 6.5 Server (Desktop Mode)

Support for myAgent for Microsoft Windows XP and Microsoft Windows Server 2003 will end at the same time as the end of support for these products by Microsoft. The product will still be supported, but will no longer be tested in detail.

Hardware Prerequisites: The number of installable clients depends on the server performance and on the amount of available memory. If the server is also being used for other applications, their memory requirements must also be taken into account.

More information on the configuration of Citrix XenApp Server can be found under:

[http://wiki.unify.com/wiki/OpenScape\\_Business](http://wiki.unify.com/wiki/OpenScape_Business).

### Installation Files

The following options are available for providing installation files to users:

- The administrator downloads the installation files from the **Service Center** and makes them available to users via a network drive, for example.

Please refer to the notes in the `ReadMe first` file, which is located in the storage directory of the install files.

---

**INFO:** The automatic distribution of the MSI file via a deployment service with Microsoft Windows Server is not supported.

---

## 17.1.3 myReports

Agents with the Supervisor or Administrator authorization level can use myReports to generate reports about agents and their activities, calls, queues, performance, GOS (Grade of Service) and wrap-up codes.

myReports offers the following features:

- More than 100 predefined report templates sorted by subject area (report groups) for the creation of reports
- Schedules for the scheduled generation of reports
- Immediate or scheduled sending of reports by e-mail
- Scheduled export of reports
- Output formats for report previews, sent e-mails and exported reports: Excel, PDF, and Word
- Report preview to check a report to be created in the desired output format.

### User Roles

myReports has its own user management, which controls access to the functions of myReports through user roles. A distinction is made here between the myReports users (standard user) and the myReports administrator.

The current user role is set when you log into myReports.

The differences between the roles are summarized in the following table.

myReports: Activity	User Role	
	myReports User	myReports Administrator
Reports		

myReports: Activity	User Role	
	myReports User	myReports Administrator
Preview report	X	X
Send report immediately by e-mail	X	X
Add report template	X	X
Delete added report template	X	X
Define new report template		X
Update predefined report templates		X
<b>Schedules</b>		
Add a schedule	X	X
Display details of a schedule	X	X
Edit schedule	X	X
Delete schedule	X	X
<b>Configuration</b>		
Change language of user interface	X	X
Change color of user interface	X	X
Configure e-mail template	X <sup>1</sup>	X
Change server address	X	X
Change administrator password		X
Configure e-mail account to send reports by e-mail		X
Configure prefixes for external phone numbers		X
Enable/disable data protection		X
Configure the storage location for the export of scheduled reports		X
language, selecting		X <sup>2</sup>
Set up default language		X <sup>2</sup>

1 The administrator password must be entered to configure the e-mail template

2 In order to configure languages and set the default language, you will need to log in as a myReports administrator with a special password.

### 17.1.3.1 How to Reset the myReports Administrator Password

#### Prerequisites

- You are logged into the WBM with the **Expert** profile.

### Step by Step

- 1) In the navigation bar, click on **Expert Mode**.
- 2) In the navigation tree, click on **Applications > OpenScape Business UC Suite**.
- 3) Click on **Server**.
- 4) Click on **Maintenance**.
- 5) Click on **Reset Password**.

### Next steps

Inform the myReports administrator(s) that you have reset the administrator password to the default password `reports`.

## 17.1.4 Prerequisites for myReports

In order to use myReports, the client PC of the subscriber must be equipped with the appropriate hardware and software configurations.

---

**INFO:** Please make sure that you refer to the notes in the `ReadMe first` file, which is located in the storage directory of the install files.

---

### Operating Systems

myReports can be used in combination with the following operating systems:

- Microsoft Windows 10 / 8.1 / 8 / 7 (both 32-bit or 64-bit are possible)
- Microsoft Windows Vista (32 bit)

---

**INFO:** The used operating system always requires the latest version of all available updates (Service Packs and patches).

---

Support for myReports for Microsoft Windows XP and Microsoft Windows Server 2003 will end at the same time as the end of support for these products by Microsoft. The product will still be supported, but will no longer be tested in detail.

### Additional Software

- Latest Oracle Java version (see **Service Center > Software**)
- Adobe Reader 9 or later (for reports in PDF format)
- Microsoft Excel 16 / 2013 / 2010 / 2007 (for reports in Excel format)
- Microsoft Word 16 / 2013 / 2010 / 2007 (for reports in Word format)

### Minimum Hardware Requirements

- 2 GHz CPU

- RAM: 2 GB
- 100 Mbps LAN (1 Gbps LAN recommended)
- XGA (1024x768) screen resolution, myPortal for Outlook: SVGA (800x600) screen resolution

### **Multi-user PCs**

Under Microsoft Windows 7 and Microsoft Windows Vista with multi-user PCs, every local user can use myReports with his or her own custom settings, provided the first local user has installed the client with local administration rights. Only the first local user with local administration rights can perform updates via the AutoUpdate.

### **Microsoft Terminal Server, Citrix XenApp Server**

myReports can be used in Microsoft Terminal Server and Citrix Server environments under the following preconditions:

---

**INFO:** Terminal Server and Citrix Server environments, including hosted services and virtual environments are the responsibility of the customer.

---

---

**INFO:** Citrix server environments can decode some regional characters (e.g., German umlauts) correctly.

---

Operating systems:

- Microsoft Windows Server 2015 (32 bit / 64 bit) as Microsoft Terminal Server
- Microsoft Windows Server 2012 (32 bit / 64 bit) as Microsoft Terminal Server
- Microsoft Windows Server 2008 R2 (64 bit) as Microsoft Terminal Server
- Microsoft Windows Server 2008 R2 (64 bit) with Citrix XenApp 6.5 Server (Desktop Mode)

Hardware Prerequisites: The number of installable clients depends on the server performance and on the amount of available memory. If the server is also being used for other applications, their memory requirements must also be taken into account.

More information on the configuration of Citrix XenApp Server can be found under:

[http://wiki.unify.com/wiki/OpenScape\\_Business](http://wiki.unify.com/wiki/OpenScape_Business).

### **Installation Files**

The following options are available for providing installation files to users:

- The administrator downloads the installation files from the **Service Center** and makes them available to users via a network drive, for example.

Please refer to the notes in the `ReadMe first` file, which is located in the storage directory of the install files.



---

**INFO:** The automatic distribution of the MSI file via a deployment service with Microsoft Windows Server is not supported.

---

## 17.1.5 Notes on Using myAgent and UC Suite Clients Simultaneously

When myAgent and other UC Suite clients are used simultaneously via one UC Suite user account, the possibility of mutual interactions cannot be excluded.

The term myPortal is used generically in this section to represent myPortal for Desktop, myPortal for Outlook, myPortal to go and myPortal for OpenStage.

Examples of mutual interactions:

- Changing the presence status via myPortal  
The examples apply to the default **Voicemail** setting for all call forwarding destinations.
  - myAgent: Agent is logged on.  
myPortal: The automatic reset of the presence status to Office is disabled. Changing the presence status via myPortal causes the agent to be immediately logged out of the queue(s). After the agent logs off via myAgent, the presence status in myPortal is reset to **Office**.  
A change in the agent status via myAgent (e.g., to **Break**) is registered by myPortal, but this does not apply to **Log in**, **Log out** and **Wrap up**.
  - myAgent: Agent is logged on.  
myPortal: The automatic reset of the presence status to Office is enabled. If the agent changes his or her status via myAgent to **Break**, he or she will be automatically available again after the break time has expired. A change of the presence status via myPortal to **Break** causes the agent to be immediately logged out of the queue(s).
  - myAgent: Agent is logged on.  
A change of the presence status via myPortal to **Do Not Disturb** causes the agent to be immediately logged out of the queue(s).
- Outbound Calls via myPortal  
The presence status of the subscriber is visible via myAgent.  
The calls appear only in the journal of myPortal. No transfer to the statistics of the Contact Center occurs, since these are not Contact Center calls.
- Incoming calls to the station number of the agent  
The presence status of the subscriber is visible via myAgent.  
The calls appear only in the journal of myPortal. No transfer to the statistics of the Contact Center occurs, since these are not Contact Center calls.
- Recording a call  
The recording of calls via myPortal is not registered by myAgent. myAgent offers this function even if the recording of a call is already occurring via myPortal.

## 17.2 Agents

The agents (stations) of a queue comprise a workgroup and are typically deployed for technical hotlines, for example, or in order processing, order acceptance, CRM, etc. The incoming calls, faxes and e-mails are distributed uniformly to the available agents for a queue.

In order to use a station of the communication system as an agent, this station must first be configured accordingly. The rights of the individual agents are defined by selecting their respective authorization levels (Agent, Supervisor or Administrator). An agent with the authorization level of a Supervisor or Administrator has elevated privileges (see *Administrator Documentation, Multimedia Contact Center*).

An agent can be defined as a permanently available agent. Such agents remain available for calls, faxes and e-mails even when they do not accept a call, fax or e-mail.

### 17.2.1 Agent Functions Independent of the Authorization Level

When a user is configured as an agent, the rights of the agent are defined by selecting the appropriate class of service for that agent (i.e., the authorization level as an Agent, Supervisor or Administrator). An agent with the authorization level of a Supervisor or Administrator has elevated privileges.

The differences between the authorization levels are summarized in the following table.

myAgent: Activity	Authorization level (class of service)		
	Agent	Supervisor	Administrator
Assign an agent to a queue	–	X	X
Move an agent to another queue	–	X	X
Remove an agent from the queue	–	X	X
Change the status of an agent	–	X	X
Display / hide the agent binding list	Assigned queues	All queues	All queues
Edit an agent assignment	–	X	X
Display list of Contact Center calls	Assigned queues	All queues	All queues
Activate myAgent screen pop automatically for alarms	–	X	X
Activate alarm tone	–	X	X
Display wallboard	Assigned queues	All queues	All queues

myAgent: Activity	Authorization level (class of service)		
	Agent	Supervisor	Administrator
Display the Grade of Service graph	Assigned queues	All queues	All queues
Display the Average Times graph	Assigned queues	All queues	All queues
Move call to first position in a queue	–	X	X
Record a call	Current call	All calls	All calls
Save recording of call as WAV file or send as WAV file by e-mail	–	X	X
Save fax as a TIFF file or send by e-mail	–	X	X
Save e-mail as EML file or send as EML file by e-mail.	–	X	X
Call monitoring (country dependent)	–	X	X
How to Override a Call	–	X	X
Accept a request for assistance	–	X	X
Create reports	–	X	X
Open WBM	–	X	X

## 17.2.2 Preferred Agents

Every caller (e.g., every calling customer) can be assigned one or more preferred agents of a queue. In such cases, the communication system first tries to switch the caller and his callback requests through to a preferred agent. If multiple preferred agents have been specified, a priority (sequence) can be defined to determine the order in which these agents are connected.

If no preferred agent is available, the call is forwarded to any available agent.

## 17.2.3 Agents in multiple queues

An agent can be assigned to multiple queues with different skill levels. In such cases, the function of the agent as a primary agent or an overflow agent must be defined.

## 17.2.4 Contact Center Breaks

In order to allow every agent the chance to take a defined break, Contact Center breaks of different lengths can be defined (e.g., for lunch or a cigarette break). Contact Center breaks are available system-wide and can be selected by an agent via myAgent as required.

## 17.2.5 Agent Login/Logout via Telephone

Login/Logout into the Contact Center is supported also via phone without the need to run myAgent in order to use the Contact Center functions. If an agent has been logged in via phone only voice calls can be processed. PopUp Window and WrapUp Code entry are not supported in this case. This applies also if myAgent is active and agent logs into the Contact Center using the phone. Full functionality of myAgent can be regained if the agent logs out via the phone and then logs in via myAgent.

### Prerequisites and Constrains

- OpenScape Business Contact Center functions via telephone only work for agents for which a myAgent license is assigned within OpenScape Business
- All functions are only supported on such phones, which are released for use with OpenScape Business Contact Center
- In case that login via phone is successful and the associated myAgent client is not active, only Voice Calls are routed to the agent
- In case that login via phone is successful and the associated myAgent client is active, Email / Fax and Callback Calls are not be presented to agent if he logs in via phone. In this case screen-pops and wrap up work as usual but only voice calls will be delivered to the agent. To get full functionality, agent has first to logout via phone mode and login afterwards via myAgent

### Login to Contact Center via Telephone

When the agents log into OpenScape Business Contact Center via the telephone, independent from myAgent client and Contact Center is active:

- The UCD functions for login are used at the phone
- The login function can either be executed via feature code or by a programmed key
- Agent is logged into all queues, to which he is assigned within the Contact Center configuration
- Telephone display informs agent about the login status
- Only UCD queue information (e.g. calls in queue information) is displayed on demand

The agent can use the following functions:

- Logon / Logoff (with UCD Agent ID)

- Wrap Up
- Available/Unavailable
- Display of calls within UCD Queue to which the UCD Agents ID has been assigned

---

**INFO:** UCD Night Service must not be used by the agent.

---

In case that Contact Center fails during agent is logged on, the agent stays logged on into UCD and voice calls are routed as configured within the UCD routing. In case that agent was not logged in he can log into UCD via telephone.

### **Logout of Contact Center via Telephone**

When the agents log out of OpenScape Business Contact Center via the telephone, independent from myAgent client and Contact Center is active:

- The UCD functions for logout are used at the phone
- The logiout function can either be executed via feature code or by a programmed key
- Agent is logged out of all queues, to which he is assigned within the Contact Center configuration
- Telephone display informs agent about the logout status
- No other Contact Center / UCD information (e.g. calls in queue information) is displayed

### **Set agent available/unavailable via Telephone**

When an agent sets his status to available / unavailable for contacts routing of OpenScape Business Contact Center via telephone independent from myAgent client and Contact Center is active:

- Telephone display informs agent about the login status
- In case that myAgent is not active only voice calls shall be routed to the agent

### **Set/Reset Working after call (Wrap Up) via Telephone**

When an agent sets his status to "Working after call" (Wrap Up) via telephone independent from myAgent client and Contact Center is active, it does not route any calls to the agent until the agent's specific Wrap up time, which is configured within OpenScape Business Contact Center, is expired or agent has reset Wrap Up via telephone.

### **Status Mapping**

Agent status change via phone is mapped as follows to myAgent agent status:

Phone Device				myAgent		
Feature Code	Feature Code	Description	Phone Display Text	Status	Additional Text	Remark
*401	UCDAgent ID	Log on UCD agents	Available	Available	-	Agent is set as available in all assigned queues
#401	-	UCD - agent log off	Not Available	Not available	-	Agent is set as not available from all assigned queues
*402	-	UCD - agent available	Available	-	-	Available (end of Work Time)
#402	-	UCD - agent not available	Not Available	Work Time	count-down from 999.999 seconds	-
*403	-	UCD work on	Wrap up	Work Time	count-down of configured work-time	Work time must be finished before it can started again. No work time cumulating like in myAgent. After work time is elapsed agent is set available automatically.
#403	-	UCD work off	Available	Available	-	-

Phone Device				myAgent		
Feature Code	Feature Code	Description	Phone Display Text	Status	Additional Text	Remark
*404	night service target	UCD night service on	-	Not supported	-	UCD Night Service must not be used
#404	-	UCD night service off	-	Not supported	-	UCD Night Service must not be used
*405	-	UCD - calls in queue	-	-	-	Only the queue to which the UCD agent ID has been assigned is shown, regardless if the agent is assigned to multiple queues within the Contact Center

## 17.3 Queues and Schedules

Queues are the basis of the Contact Center. Calls, faxes and e-mails for a queue can be handled, depending on the skill levels of agents, the priorities and waiting periods. Announcements can be played for waiting callers. A schedule is used to define how incoming calls are to be handled on certain days and at specific times.

### 17.3.1 Queues

As a rule, call distribution occurs by sending any incoming call, fax or e-mail for a queue to the specific station in the group (i.e., the agent) whose last call lies furthest in the past. It is also possible to define other distribution rules (based on the different skill levels of agents, for example). If all agents are busy, any additional calls, faxes and e-mails are placed in the queue and then distributed to the next free agent based on their priority and the waiting time.

Schedules and the rules contained in them (i.e., the CCVs or call control vectors) can be used to define how a call to a queue at a specific time and on a specific date is to be handled. The rules define which announcement is to be played back to callers, for example, or where a call is to be forwarded.

Faxes, e-mails and agent callbacks are assigned to queues directly, independently of schedules.

When assigning agents to queues, different properties, which affect the distribution of calls in a queue, can be assigned to agents (e.g., Primary Agent or Overflow Agent and Skill Level). Agents can be assigned to queues

- via the WBM by an administrator with the **Advanced** profile.
- via the application myAgent by an agent with the Supervisor or Administrator authorization level.

If an agent is assigned to multiple queues, the queue priority can be used to define whether calls for a queue with higher priority should be forwarded to this agent with precedence over calls for other queues.

The following main settings can be made for queues via the WBM:

- Activating, deactivating and deleting queues  
Note: After the deletion of a queue, no reports for past time periods can be generated. Queues that are no longer required should be deactivated.
- Configuring queue alarms  
You have the following options:
  - Queue Alarm Count (alarm threshold value): If the number of calls waiting in the queue exceeds the number specified here, the queue symbol for the agent changes from green to orange. Agents with the Supervisor or Administrator authorization level can set whether they should be warned with an alarm tone and whether myAgent should be automatically brought to the foreground with a screen pop.
  - Queue Alarm Time (alarm threshold value): If the waiting time for a queued call exceeds the time specified here, the corresponding item in the list of Contact Center calls for the agents changes to red. Agents with the Supervisor or Administrator authorization level can set whether they should be warned with an alarm tone and whether myAgent should be automatically brought to the foreground with a screen pop.
- Defining timeouts for missed calls, faxes and e-mails  
If a phone call, fax or e-mail is not accepted by the agent at the end of the time specified here, the call, fax or e-mail will be forwarded to the next available agent.
- Defining an abandoned call threshold  
The time specified here determines whether or not an abandoned call is included in the statistics (i.e., in a report). Calls abandoned after the specified time has elapsed are included in the statistics.
- Configuring queue depth  
Control of the maximum number of active and waiting calls in a specific queue. The Contact Center indicates to the system that the defined threshold of the queue size is reached. As a result the system rejects every new incoming call for the appropriate queue before the call is connected with the system, until the number of calls falls below the threshold.  
The maximum queue size is determined by following parameters:
  - Maximum number of waiting positions within the queue. (WLS = Waiting Loop Size)
  - Maximum number of active and waiting calls of the queue.(Queue Depth Size).



- **Setting up inbound fax pilots**  
If configured, station numbers can be selected for incoming Fax messages. Faxes to these phone numbers will then be added to the queue and treated as incoming calls.
- **Setting up an inbound e-mail service**  
Multiple e-mail addresses can be set up for a queue. E-mails sent to these addresses are placed in the queue and treated like incoming calls.
- **Setting up a return e-mail address**  
E-mail address of the queue, which is displayed to the recipient when an e-mail is sent by an agent.
- **Activating intelligent call routing**  
An incoming call is forwarded to the agent with whom the caller was last connected, provided no preferred agent was defined for that caller.

## 17.3.2 Schedules

For each queue, a schedule can be defined with rules (Call Control Vectors or CCVs) to determine how incoming calls are to be handled on specific dates and at specific times.

For example, on work days, separate rules may be defined for the morning shift (from 6:00 to 14:00 hours), the afternoon shift (14:00 to 22:00 hours) and the night shift (from 22:00 to 06:00 hours). Similarly, a weekend rule can be defined for the weekends. For each of these rules, you can define whether an announcement is to be played, for example, and/or the destination to which the calls are to be forwarded.

Schedules are the core of the Contact Center configuration. Without the definition of at least one schedule, the configuration of a Contact Center cannot be completed successfully. Every queue must be assigned at least one schedule. This may also be the same schedule in every case.

A schedule, in turn, must have at least one rule (called a Call Control Vector or CCV) assigned to it. The rules determine how incoming calls for a queue are to be handled during the time period to which the schedule applies. Rules apply only to calls and not to faxes and e-mails.

Rules are created with the graphical rule editor (CCV Editor) by combining predefined CCV objects and can be saved under a user-defined name upon completion.

Saved rules can be assigned to one or more schedules as a default rule (default CCV) or an exception rule (exception CCV). They can be opened, edited and saved again at any time by using the rule editor.

After a schedule has been assigned a default rule (default CCV), this schedule can be saved under a user-defined name. A schedule with an assigned default rule applies to a queue 24 hours a day, 365 days a year. If different rules are to be applied at certain times (breaks, weekends, holidays, vacations, etc.), these can be assigned to the schedule as exception rules (Exception CCV). This means that you can define how incoming calls are to be handled during the holiday schedule,

for example. Holiday schedules have precedence over the other schedules and rules of a queue.

### **Rule Editor (CCV Editor)**

The Rule Editor is used to create rules from predefined CCV objects. The arrangement of the CCV objects and their properties determine how incoming calls are to be handled.

The following predefined CCV objects are available:

---

**INFO:** For all of the named CCV objects, the two general properties listed below also apply:

**Description:** Optional entry to describe the CCV object, e.g., Greeting.

**Process digit:** specification of the digit(s) required without blanks, commas or other characters. The specification refers to the preceding CCV object. If 9 was specified there under Accepted Digits, then 9 must also be entered here.

---

- **Play Message**

Causes the desired message to be played. Any audio file present in the UC Suite can be selected. In addition, a new audio file can be imported into the UC Suite or a new announcement can be recorded and then imported as an audio file into the UC Suite.

The playback of the announcement seizes one respective Media Stream channel.

Properties:

- **File Name:** Selection of an announcement (audio file in WAV format)
- **Interrupt Digits:** specification of a key or key combination on the dial pad with which callers can stop the playback of an announcement.
- **File Manager:** Using this button, it is possible to directly upload an audio file in wav format or create a new voice file with the recording device.

- **Music on Hold**

Causes Music on Hold (MOH of the communication system) to be played for external calls for an adjustable period of time

Property:

- **Time Value:** Time, in seconds, for which the Music on Hold is to be played.

- **Disconnect Caller**

Causes the call to be disconnected.

After this CCV object, no further CCV object may be inserted.

- **Play Queue Position**

Causes information on the current queue position of the caller to be played.

- **Go to CCV**

Causes a loop to another CCV object

Property:

- **Target CCV:** Selection of the CCV object

- **Record Callback**

Enables a caller in a queue to enable an agent callback (record a voicemail). Instead of the actual caller, the agent callback remains in the queue. For agents with the **Enable agent callback** feature, the agent callback appears in the list of Contact Center calls.

After this CCV object, no further CCV object may be inserted.

Properties:

- **Type:** Selection of **Simple Callback** or **Extensive Callback**.

In contrast to simple callbacks, extensive callbacks offer callers additional options and information (e.g., the option to confirm or change the phone number that is to be called back and the option to confirm the voicemail).

- **Maximum message length:** Time, in seconds, that is available to a caller when recording a voicemail.

- **Process after digits**

Causes the next CCV object(s) to be executed, depending on the digits specified there (process digit).

Properties:

- **File Name:** Selection of one or more announcements (audio file in WAV format)

- **Playlist:** List of selected announcements (audio file in WAV format) in the order in which they are played

- **Digits Timeout:** Time, in seconds, for which the communication system waits for the input of digits.

If the required digits are not entered fully within the specified time, the message (announcement) is played again.

- **Link To:** List of digits with destination.

The digits and destinations can be added, edited and removed.

- **File Manager:** Using this button, it is possible to directly upload an audio file in wav format or create a new voice file with the recording device.

The contents of the Playlist are presented in the Rule Editor by a tool tip on hovering with the mouse pointer over the CCV object.

- **Single-step transfer**

This function depends on the **Normal Attendant Console SST** setting (WBM, **Expert mode: Applications > OpenScape Business UC Suite > Server > General Settings**):

- **Normal Attendant Console SST** enabled (default setting; not for U.S.): Causes the call to be transferred, regardless of whether the destination is free, busy or unavailable.

---

**INFO:** For stations with call waiting rejection enabled, the call is switched through only if the destination station is free. No call waiting on busy occurs.

---

- **Normal Attendant Console SST** disabled (default setting, only for U.S.): Causes the call to be transferred if the destination is free.

If the destination is busy and call waiting rejection is disabled, or if the destination is unavailable, an announcement is played back to the caller. The caller can then optionally choose to leave a message in the voicemail

box of the called subscriber or select the call number of another destination.

If the destination is busy and call waiting rejection is enabled, the call is not switched through.

After this CCV object, no further CCV object may be inserted.

Property:

- **Target Extension:** specification of the internal call number or external DID extension with the number of the CO trunk. Blanks, commas and other characters are not allowed.

The call number of the target extension is displayed in the CCV object.

---

**INFO:** After Single-Step-Transfer, the system disconnects the call after ringing for 5 minutes.

---

- **Transfer To Queue**

Causes the call to be transferred to a queue.

After this CCV object, no further CCV object may be inserted.

Property:

- **Queue:** Selection of the queue

- **Record In Mailbox**

Causes the call to be sent to the desired voicemail box of a subscriber or a voicemail group

After this CCV object, no further CCV object may be inserted.

Property:

- **User Mailbox:** specifies the station number of the voicemail box of a subscriber or voicemail group

The station number and the name of the voicemail box or voicemail group are shown in the Rule Editor by a tool tip on hovering with the mouse pointer over the CCV object.

- **Supervised Transfer(also called screened transfer)**

Causes the call to be transferred to an internal destination. During the transfer, Music on Hold (MOH of UC Suite) is played back to the caller.

In contrast to the single-step transfer CCV object, two further CCV objects must be inserted here. This is because we now need to define how the communication system should behave if the call destination is busy or does not answer the call. Usually, an announcement is played to the caller in such cases.

Properties:

- **Target Extension:** Specification of the internal phone number.  
Only internal call numbers are supported in the own node. Forwarding to external destinations, virtual stations, additional AutoAttendants, UCD (incl. Contact Center), Mobility users as well as external CallMe destinations is not allowed! For these scenarios, the SST (single-step transfer) should be used.
- **Ring Timeout:** Time, in seconds, within which the call must be accepted.  
If the call is not answered within the specified time, it is returned to the communication system, and the next CCV object is used.

---

**INFO:** The time specified here must be shorter than the time configured for call forwarding (the default setting for call forwarding = 15 seconds). See *Administrator Documentation, Functions at the Telephone*.

---

- **Pull back call if destination device is forwarded / deflected:** Option (only applicable for internal call number.)  
If this option is enabled, the call destination is first checked, and if a forwarding destination or deflection has been set for it, the call is returned to communication system, and the next CCV object is used.
- **Check Presence status when transferring call:** Option  
If this option is enabled, the presence status of the call destination is checked, and if this status is any presence status other than Office, the call is returned to communication system, and the next CCV object is used.
- **Dial By Name**  
Causes the caller to be prompted to enter the first three letters of the desired subscriber's last name via the dial pad.  
If a unique subscriber name with the entered initial letters is found, a connection is established.  
If there are several subscriber names with the entered initial letters, these subscriber names are announced to the caller (max. 10 subscribers). If a subscriber has no recorded name announcement, the call number is announced instead. After selecting the desired subscriber, a connection is made.  
If none of the subscribers match the entered initial letters, the caller receives a corresponding message.

---

**INFO:** The keys on the dialpad respond to the first press of a key. With each key pressed, the system tries to determine whether there are subscriber last names with the letter assigned to that key.

Example: Let us assume the internal phone book has five last names with the initial letters t, u and v: Taylor, Taler, Ullrich, Vasquez and Volterra. To establish a connection with the subscriber Taylor, following keys must be pressed: 8 2 9

---

After this CCV object, no further CCV object may be inserted.  
Properties:

- **Method:** Selection of **Transfer To Extension** or **Record In Mailbox**.  
Depending on the method selected, a connection to the desired extension or its voicemail box is established. Note that only internal extensions for which the first and last names of the subscriber are entered in the internal directory are supported here.

- **Dial By Extension**

Causes the caller to be prompted to enter the station number (extension) of the desired subscriber via the dial pad.

If the caller dials the station number of a virtual station, the caller is prompted to enter another station number. A connection is then established. If the desired subscriber does not respond, the call is accepted by his or her voicemail box.

After this CCV object, no further CCV object may be inserted.

Properties:

- **Method:** Selection of **Transfer To Extension** or **Record In Mailbox**.

Depending on the method selected, a connection to the desired extension or its voicemail box is established. Note that only internal extensions in the network for which the phone number is entered in the internal directory are supported here.

- **Set language**

Selects the language for each standard announcement based on the phone number of the caller. It should be noted that only standard announcements (i.e., system announcements) and no personal greetings are taken into account here.

For example, it is possible to have German announcements played back to callers with the country code 0049 and French announcements for callers with the country code 0033.

Properties:

- **Default language:** Drop-down list to select a language.

The language selected here is used for all phone numbers for which no specific language was defined.

- **Pattern:** Specifies the phone numbers to which a particular language is to be assigned.

The following placeholders can be used \* = any digit, ? = any digit.

- **Language:** Drop-down list to select the language to be assigned to the relevant phone numbers (matching **Pattern**).

A language can be assigned to any number of different phone numbers (matching **Pattern**).

- **CLI Routing**

Causes the forwarding of a call to one or more sequential CCV objects based on the caller's number.

For example, it is possible to first have a German announcement played back to callers with the country code 0049 (CCV object **Play Message**) and then have the call forwarded to an internal phone (CCV object **Single Step Transfer**).

Properties:

- **Standard:** Drop-down list to select the CCV object.

The CCV object selected here is used for all phone numbers for which no specific destination was defined.

- **Pattern:** Specifies the phone numbers to which a specific CCV object is to be assigned as the destination.

The following placeholders can be used \* = any digit, ? = any digit.

- **Description**  
Provides an explanation.  
For the **Pattern** 0049 (= country code for Germany), for example, Germany can be entered.  
The text entered here will appear in the Rule Editor.
- **Target:** Drop-down list to select the CCV object that is to be assigned as a destination to the related phone numbers (matching **Pattern**).  
A CCV object can be assigned as a destination to any number of different phone numbers (matching **Pattern**).
- **Branch on variable**  
Causes the forwarding of a call to one or more sequential CCV objects based on a given condition.  
You can thus define, for example, that an announcement (such as "Please call again later ...") should be played back to callers as soon as there are more than 20 calls in a queue.  
Properties:
  - **Variable:** Selection of **Calls** or **Available agents**.  
Depending on the selected variable, the number of calls waiting in a queue or the number of available agents (including agents in wrap up time) is used as the defined condition. In the associated drop-down list, the condition (**less than, greater than, less than or equal to, equal to or greater than, equal to**) must be selected, and the comparison value must then be entered in the corresponding input field.
  - **True branch:** Drop-down list to select the CCV object that is to be used as a destination when the condition is satisfied.
  - **False branch:** Drop-down list to select the CCV object that is to be used as a destination when the condition is not satisfied.The number of available agents in a queue is affected by the following status changes of the agents:
  - Login of an agent into the queue using "Anmelden/Login": --> +1
  - Logout of an agent from the queue using "Abmeldung/Logout": --> -1
  - Agent in the status "Break":-->-1
  - Agent in the status "Available after Break":--> +1The number of available agents in a queue is **not** affected by the following status changes of the agents:
  - Agent in the status "Ringing"
  - Agent in the status 'Talking'
  - Agent in the status "Wrap up"
  - Agent in the status "Missed Call"
  - Agent in the status "Overdue"
- **Branch on data**  
Causes the forwarding of a call to one or more sequential CCV objects based on a given condition.  
You can thus define, for example, that an announcement (such as "Please call again later ...") should be played back to callers as soon as there are more than 20 calls in a queue.  
Properties:

- **Variable:** Selection of **LDAP data1 (xmpp)** or **LDAP data2 (pager)**. The data query is done via LDAP either directly to an LDAP capable database or indirectly via the Directory Service (ODS) to an SQL / ODBC database. The query results are assigned via the UC Suite LDAP field mapping to the appropriate criterias of the Contact Center. In the associated drop-down list, the condition (**less than, greater than, less than or equal to, equal to or greater than, equal to**) must be selected, and the comparison value must then be entered in the corresponding input field. It is necessary to map the keywords "pager" and "info".
- **Timeout:** The time in seconds before a timeout occurs.
- **Timeout branch:** Drop-down list to select the CCV object that is to be used as a destination when timeout occurs.
- **True branch:** Drop-down list to select the CCV object that is to be used as a destination when the condition is satisfied.
- **False branch:** Drop-down list to select the CCV object that is to be used as a destination when the condition is not satisfied.
- **Description:** Provides an explanation.

### 17.3.3 Wrap up

Wrapup reasons can be used to assign incoming calls to specific categories (orders, complaints, service, etc.). The assignment is made by an agent after completing the call (during the wrap-up time) by entering the appropriate wrapup reason using myAgent.

Wrapup reasons can be defined individually for each queue.

A distinction is made here between:

- **Simple Wrapup**  
One or more wrapup reasons can be defined for queues with the wrapup mode "Simple Wrapup".  
Example: The two wrapup reasons "hardware problem" and "software problem" were defined for a queue. Every call is assigned one of these wrapup reasons by an agent during the wrapup time. This makes it possible to subsequently create a report with an overview of all calls related to the subject of hardware problems, for example.
- **Multiple Wrapup**  
For queues with the wrapup mode "Multiple Wrapup", one or more wrapup reasons can be defined and then classified into groups and subgroups.  
Example: A Hardware group with the wrapup reasons Motherboard and Power Supply and a Software group with the wrapup reasons Operating System and Drivers were defined for a queue. Every call is assigned one of these wrapup reasons by an agent during the wrapup time. This makes it possible to subsequently create a report with an overview of all calls related to hardware problems or also all calls related specifically to motherboard hardware problems.



### 17.3.4 Grade of Service

The Grade of Service can be used to assess the response rate of the queue. This is achieved by comparing the waiting time for callers in the queue with target values, which can be specified individually for each queue.

The target values for the Grade Of Service (GoS) can be defined freely, depending on the acceptable waiting time for callers in a queue. For each call to an appropriate queue, the service level is determined after the call and committed to the database. The Grade of Service can be evaluated by agents with the authorization level of a Supervisor or Administrator by using the myAgent application.

### 17.3.5 Wallboard

Queue details can be retrieved and displayed using myAgent. The display contains a table with statistical information on queues in real time for the current 24-hour period. The display can then be presented on a large LCD monitor, for example, or via a beamer (wallboard).

Agents with the agent authorization level receive information on the queues to which they are assigned. Agents with the Supervisor or Administrator authorization level receive information on all queues.

A separate station should be set up for a wallboard display. A Station license (IP User or TDM User) and a myAgent license are required for this.

### 17.3.6 Agent Callback

If the waiting time in the queue is too long for a caller, and the associated schedule includes the CCV object **Record Callback**, the caller can leave a callback request. This callback request retains the original position of the caller in the queue and is delivered to the agent in the form of a voicemail. After listening to the voice message, the agent can call back the caller via a screen pop.

If a preferred agent has been set for a caller, an attempt is first made to route the callback requests of that caller to the preferred agent. If the preferred agent is not available, the callback request is forwarded to any available agent.

## 17.4 VIP service

For each queue, you can individually define whether certain callers (with a VIP status) or callers which match configurable call number patterns should be given preferential treatment and thus allowed to reach a free agent faster.

If all agents of a queue are busy, VIP callers are preferentially connected to the next available agent.

## 17.4.1 VIP Caller Priority

The VIP Caller Priority can be defined individually for each queue in order to specify whether callers (customers, for example) included in the VIP Call List should be given preferential treatment.

The values for the VIP Caller Priority can be defined freely, depending on the waiting time for callers in a queue. This determines the level of preference for VIP callers as opposed to normal callers.

When a VIP caller activates an agent callback (by recording a voicemail with a callback request), the agent callback is retained in the queue instead of the VIP caller. but without the VIP Caller Priority.

VIP callers must be registered in the VIP call list directory (see [VIP Call List](#)).

## 17.4.2 VIP Call List

Callers who have already been registered in the communication system (external directory) can be added to the VIP call list. Multiple selection can be done or the "**Select All**" function can be used. In addition, call number patterns can be entered. A call number pattern consists of a specific sequence of digits and a wildcard (placeholder). It can thus be used to transfer all employees of a company to the VIP call list, for example.

For each queue, the VIP caller priority can be used to define whether

- the callers included in the VIP call list and
- the callers who match the call number pattern contained in the VIP call list should be given preferential treatment.

It is not possible to enter call number patterns in the canonical call number format. The use of shortcut characters for country codes (for example +49 instead 0049) is likewise not possible. Call number patterns must always be specified without the CO access code.

Examples of call number patterns:

- 089 7577\* (089 = area code for Munich, 7577 = PABX number of a company, \* = wildcard for any number). By entering this call number pattern in the VIP call list, all callers from Munich, whose telephone number begins with 7577, are given priority.
- 0039\* (0039 = country code for Italy, \* = wildcard for any number). By entering this call number pattern in the VIP call list, all callers from Italy are given priority.

The following characters can be used as wildcards (placeholders) in a call number pattern:

- \* = wildcard for any number
- ? = wildcard for any digit

## 17.5 Fallback solution

If the Contact Center is unavailable due to problems (crash, connection down, etc.) the "Uniform Call Distribution (UCD)" feature of the communication system is automatically used. This feature thus serves as the fallback solution for the Contact Center.

In the event of a failure in the Contact Center, incoming calls are distributed according to the fallback solution. The distribution of faxes and e-mails is not possible.

Depending on requirements, one of the fallback solutions described below can be configured.

### Default Fallback Solution

In this case, the fallback solution is based on the UCD IDs (agent IDs) of the agents:

- Agents are assigned to the UCD groups of the communication system based on UCD IDs. The UCD ID determines to which UCD group this agent is assigned in the event of a failure at the Contact Center.

To ensure that the default fallback solution works properly, every queue must be assigned the Contact Center agents with the UCD IDs that were assigned to the appropriate UCD groups.

In the event of a failure in the Contact Center, incoming calls are distributed to the logged in agents via the different UCD groups.

Example:

- UCD IDs 103, 104 and 105 are assigned to UCD group ABC. UCD IDs 108, 109 and 110 are assigned to UCD group XYZ.
- The stations 123, 124 and 125 are configured as agents with the UCD IDs 103, 104 and 105. The stations 126, 127 and 128 are configured as agents with the UCD IDs 108, 109 and 110.
- When assigning agents to queues, the stations 123, 124 and 125 must be assigned to the queue ABC, and the stations 126, 127 and 128 to the queue XYZ.

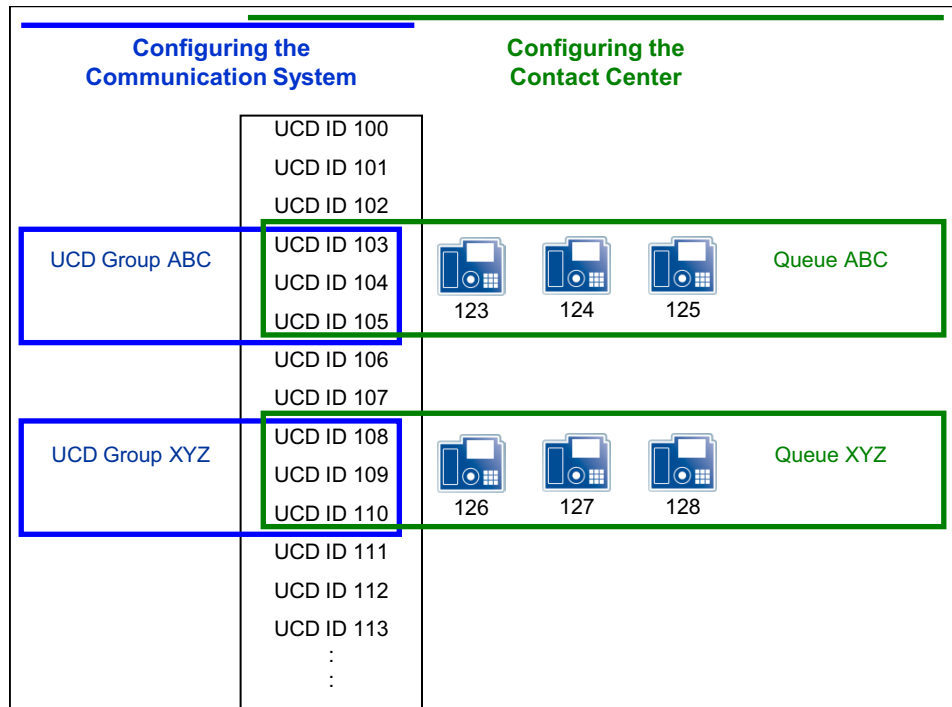

**Basic fallback solution**

In this case, all agents of the Contact Center are assigned using their UCD IDs to only the Backup UCD group. By assigning the appropriate agents, these UCD IDs are then also used in the queues of the Contact Center. This ensures that in the event of a failure in the Contact Center, the agents do not have to manually log in at their phones with a different ID. This Backup UCD group is defined as a second call forwarding destination for all UCD groups of the communication system.

If the Contact Center fails, the incoming calls are then distributed to all agents of the backup UCD group.

Example:

- No UCD IDs were assigned to the UCD groups ABC and XYZ. UCD IDs 103 to 105 and 108 to 110 were assigned to the UCD group BACKUP.
- The stations 123, 124 and 125 are configured as agents with the UCD IDs 103, 104 and 105. The stations 126, 127 and 128 are configured as agents with the UCD IDs 108, 109 and 110.
- When assigning agents to queues, the stations 123, 124 and 125 are assigned to the queue ABC, and the stations 126, 127 and 128 to the queue XYZ.

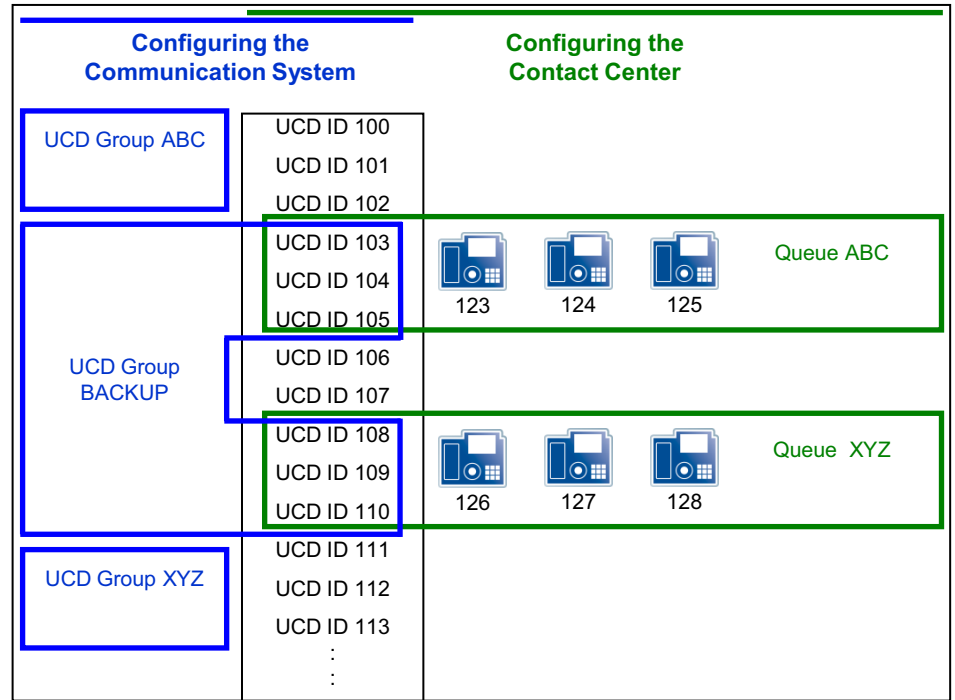

### Custom fallback solution

In this case, the customized configuration of the Contact Center is mapped via multiple UCD groups.

If the Contact Center fails, similar behavior is thus achieved by the fallback solution.

For details on configuring call distribution via the "Uniform Call Distribution (UCD)" feature of the communication system, see [UCD \(Uniform Call Distribution\)](#).

The main advantage of the of the custom fallback solution, by contrast, lies in its accurate mapping of the Contact Center operations.

The disadvantage of the custom fallback solution is the high configuration effort involved. Furthermore, to achieve similar call distribution behavior, all changes made to the Contact Center configuration also need to be mapped to the fallback solution.

The main advantage of the default and basic fallback solution is the easy configuration.

## 17.6 Configuring the Contact Center

When configuring the Contact Center, the UCD groups must be defined first. The queues of the Contact Center are essentially workgroups that are based on the UCD groups of the communication system. The actual configuration of the Contact Center (schedules, queues, etc.) can then be performed.

Before configuring the Contact Center, the standard processes for call distribution in normal and emergency modes must be coordinated with the customer.

---

**INFO:** The configuration of the Contact Center should only occur after the setup of the communication system and the UC suite have been fully completed.

---

If changes are made to the configuration of the UCD groups, then the UC Suite must be subsequently restarted via the Service Center of the WBM.

The following licenses are a prerequisite for the operation of a Contact Center:

- An appropriate number of licenses for agents (myAgent)
- Contact Center Fax License (for receiving and sending faxes), if necessary
- Contact Center E-mail License (for receiving and sending e-mails), if necessary

## 17.6.1 Example of a Contact Center Configuration

The operating principle of the Contact Center with OpenScape Business is presented here with the aid of an example. The structure and configuration of the example are based on a fictional customer scenario with standard Contact Center functions.

### Sample Scenario for a Contact Center

Company XYZ operates a Contact Center with the following station numbers (queues):

- Station number 440 for the Service Department
- Station number 444 for the Sales department
- Station number 456 for free calls (Hotline). Callers receive an announcement and can then reach the Service or Sales Department by selecting the appropriate digit.

The Contact Center consists of six employees (agents), of which three work for the Service Department and three for Sales.

The queues for the Service and Sales Departments should be directly reachable during normal business hours from 09:00 to 17:00 hours. Both queues have a fax box and an e-mail address.

If all agents are busy or not available, callers are to be notified accordingly and have music played back to them. If no agent becomes free after a certain period of time, a caller can leave a callback request or reach the Attendant by dialing a specific number. If no digit is dialed, the caller should be automatically placed back in the queue.

During closed hours, callers are to hear an announcement enabling them to record a voicemail with a callback request (agent callback).

---

**INFO:** Playing announcements are only possible via trunks. In order to play the announcement the call must come from a trunk or the caller should be monitored by OpenScape Contact Center.

---

During the lunch break from 12:00 to 13:00 hours, an announcement is to be activated for the Service and Sales Departments to offer callers the option of recording a message with a callback request.

Fallback solution via Backup UCD group: If the Contact Center is unavailable due to problems (such as a system crash, dropped connection, etc.), the system should automatically switch to the "Uniform Call Distribution UCD" feature of the communication system as a fallback solution. This requires all of the Contact Center agents to be assigned to a single backup UCD group. For all UCD groups of the communication system, this Backup UCD group should be defined as a call forwarding destination. If the Contact Center fails, the incoming calls will then be distributed to the agents of the Backup UCD group.

### Configuring the Sample Scenario

The following actions must be performed for this sample scenario:

- **Configure UCD groups**  
The queues of the Contact Center are essentially workgroups that are based on the UCD groups of the communication system. The UCD groups must be defined before the actual configuration of the Contact Center.  
For this example of the Contact Center of company XYZ, three UCD groups (Service, Sales and Hotline) are to be configured.
- **Configure the fallback solution**  
For this example, a Backup UCD group is to be configured and defined as a call forwarding destination for all UCD groups of the communication system.
- **Configure subscribers as agents**  
For this example, six subscribers must be configured as agents.
- **Record individual announcements**  
For this example, various announcements are to be recorded. This includes an announcement for situations when no agent is available, for example, or an announcement to inform callers about possible options (using **Process after digits**).
- **Load individual announcements**  
For this example, the recorded announcements are to be loaded into the communication system.
- **Define schedules**  
For each time interval within a schedule, rules (Call Control Vectors or CCVs) can be defined to determine how incoming calls are to be handled on specific days and at specific times.  
In the example, a standard schedule XYZ is to be defined with a rule for the times outside business hours and with exceptions for business hours and the lunch break. In addition, a second schedule (Standard Schedule Hotline) to be defined with a rule for free calls (Hotline).

Schedule	Rule (CCV)	
Standard Schedule XYZ	Out of the Office	Times outside business hours
	Open	Business hours 08:00 to 11:59 hours = Open1
		Business hours 13:00 to 17:00 hours = Open2
Lunch Break	Lunch 12:00 to 12:59 hours	
Standard Schedule Hotline	Hotline	24 Hours

- Adding three queues  
In this example, one queue is to be configured for the Service Department and one for Sales. A further queue (hotline) is to be configured for free calls.
- Assign agents to queues  
For this example, three agents are to be assigned to the Service queue and three to the Sales queue.

More details on the configuration of all Contact Center functions can be found under the [Configuration Procedure](#).

### 17.6.1.1 How to Configure UCD Groups for the Sample Contact Center

This example shows you how to use the **UCD** wizard to define the three UCD groups (Service, Sales and Hotline) with the station numbers 440, 444 and 456 for the sample Contact Center of company XYZ.

#### **Prerequisites**

- You are logged on to the WBM with the **Advanced** profile.

#### **Step by Step**

- 1) In the navigation bar, click on **Setup**.
- 2) In the navigation tree, click **Wizards > User Telephony**.
- 3) Click on **Edit** to start the **UCD** wizard. The list of all possible UCD groups is displayed.
- 4) To configure a UCD group, click **Edit** in the row containing the required UCD group.
- 5) Enter the call number 440 of the Service UCD group in the **Call number** field.
- 6) Enter the DID number 440 of the Service UCD group in the **Direct inward dialing number** field.
- 7) Enter the name **Service** in the **Name** field.
- 8) Click on **OK & Next**. The window **Assignment of UCD Agents** is displayed.



- 9) Click on **OK & Next**, since no UCD IDs may be assigned for the UCD group Service.

Since a fallback solution via a Backup UCD group is to be set up for the sample Contact Center of company XYZ, no UCD IDs should be assigned to the three UCD groups Service, Sales, and Hotline.

- 10) Click on **OK & Next**. The **Edit announcement/overflow** window appears.
- 11) Click on **OK**, since the displayed parameters are not relevant for the configuration of the UCD group.
- 12) Repeat steps 4 through 11 for the UCD group Sales with the call number 444 and for the UCD group Hotline with the call number 456.
- 13) Click on **OK & Next**, followed by **Finish**.

### 17.6.1.2 How to Configure a Fallback Solution for the Sample Contact Center

You can configure the Backup UCD group with the call 400 for the sample Contact Center of company XYZ with **UCD** wizard. In the example, the UCD agent IDs 101 to 106 are used. In addition, you will define the Backup UCD group as a call forwarding destination for all UCD groups of the sample Contact Center of company XYZ.

#### **Prerequisites**

- You are logged on to the WBM with the **Advanced** profile.

#### **Step by Step**

- 1) In the navigation bar, click on **Setup**.
- 2) In the navigation tree, click **Wizards > User Telephony**.
- 3) Click **Edit** to start the **UCD** wizard. The list of all possible UCD groups is displayed.
- 4) To configure a UCD group, click **Edit** in the row containing the required UCD group.
- 5) Enter the call number 400 of the UCD group Backup in the **Call number** field.
- 6) Enter the DID number 400 of the UCD group Backup in the **Direct inward dialing number** field.
- 7) Enter the name Backup in the **Name** field.
- 8) Click **OK & Next**. The window **Assignment of UCD Agents** is displayed.
- 9) Mark the required UCD agent IDs in the **Selection** and assign them to the UCD group Backup by clicking **Add**.
- 10) Click **OK & Next**. The **Assign stations** window appears.
- 11) Assign the desired stations to all UCD agent IDs.
- 12) Click **OK & Next**. The **Edit announcement/overflow** window appears.

- 13) Click **OK**, since the displayed parameters are not relevant for the configuration of the UCD group Backup.
- 14) To configure the new Backup UCD group as a call forwarding destination for the UCD group Service, click in the row of the UCD group Service on **Edit**.
- 15) Click **OK & Next** until the **Edit announcement/overflow** window appears.
- 16) Select the UCD group Backup with the call number 400 as the call forwarding destination in the **Overflow destination** drop-down list.
- 17) Click **OK**.
- 18) Repeat steps 14 through 17 to configure the new UCD group Backup as the call forwarding destination for the UCD groups Sales and Hotline, respectively.
- 19) Click on **OK & Next** followed by **Finish**.

### 17.6.1.3 How to Configure a Subscriber as an Agent for the Sample Contact Center

This example shows you how to use the **User Directory** wizard to configure subscribers as agents for the sample Contact Center of company XYZ. In the example, the subscribers with the station numbers 101 to 106 are configured as agents. The subscribers with the station numbers 101 and 104 are assigned the **Supervisor** authorization level, and the other subscribers are assigned the authorization level of an **Agent**.

#### *Prerequisites*

- You are logged on to the WBM with the **Advanced** profile.

#### *Step by Step*

- 1) In the navigation bar, click on **Setup**.
- 2) Click in the navigation tree on **Wizards > UC Suite**.
- 3) Click on **Edit** to start the **User Directory** wizard.
- 4) Mark the subscriber with the **Extension** 101 and click **Edit**.
- 5) Click in the menu tree on **Personal Details > User Level**.
- 6) Select the **Permanently available agent** check box. The agent will then remain available for calls, faxes and e-mails even when he or she does not accept a call, fax or e-mail.
- 7) Select the **Supervisor** authorization level in the **Level** drop-down list.
- 8) Click **Save**.
- 9) Repeat steps 4 through 8 to configure the subscribers with the station numbers 102 to 106 as agents.

### 17.6.1.4 How to Add Announcements for the Sample Contact Center

You can record announcements for the sample Contact Center of company XYZ with the **Recorder** wizard. Among other things, an announcement is needed for situations in which all agents are unavailable.

#### *Prerequisites*

- You are logged on to the WBM with the **Advanced** profile.

#### *Step by Step*

- 1) In the navigation bar, click on **Setup**.
- 2) Click in the navigation tree on **Wizards > UC Suite**.
- 3) Click on **Edit** to start the **Recorder** wizard.
- 4) Select the station number of the phone to be used for recording from the **Extension** drop-down list.
- 5) Click on **Begin**. The selected station number is called.
- 6) Pick up the handset and enter the name for your announcement in the **File Name** field.
- 7) Click on **Record** to start recording the announcement.
- 8) Click on **Stop** as soon as you have finished recording the entire announcement.
- 9) If you want to listen to your new announcement, click on **Play**.
- 10) Click on **Close** to save the announcement.

---

**INFO:** After the announcement has been recorded and saved, it can no longer be deleted. However, it can be overwritten by saving another file with the same file name. For example, saving an audio file named `announcement1.wav` would overwrite any existing `announcement1.wav` file.

---

- 11) Repeat steps 3 through 10 to record further announcements for the sample Contact Center of company XYZ.

### 17.6.1.5 How to Load Announcements for the Sample Contact Center

You can upload announcements for the sample Contact Center of company XYZ with the **File Upload** wizard.

### **Prerequisites**

- An audio file in .wav format is available with the following properties: mono, audio sample rate 8 kHz, audio sample size 16 bit, frame size 2.
- You are logged on to the WBM with the **Advanced** profile.

### **Step by Step**

- 1) In the navigation bar, click on **Setup**.
- 2) Click in the navigation tree on **Wizards > UC Suite**.
- 3) Click on **Edit** to start the **File Upload** wizard.
- 4) Click on the **Load audio files** tab.
- 5) Select the destination **Attendant Console** in the **Upload Destination** drop-down list.
- 6) Click on **Browse**, navigate to the desired storage location of the audio file and click on **Open**.
- 7) Click on **Upload**.

---

**INFO:** After the audio file is uploaded, it can no longer be deleted. However, it can be overwritten by uploading another file with the same file name. For example, uploading an audio file named `announcement1.wav` would overwrite any existing `announcement1.wav` file.

---

- 8) Repeat steps 4 through 7 to load further announcements for the sample Contact Center of company XYZ.

## **17.6.1.6 How to Add the Standard Schedule XYZ for the Sample Contact Center**

This example shows you how to use the **Contact Center** wizard to define a schedule with rules for breaks and business hours for the sample Contact Center of company XYZ. In the example, a schedule (Standard Schedule XYZ) is to be defined with a rule for the times outside business hours (Out of the Office) and exceptions for the business hours (08:00 to 11:59 hours = Open1, 13:00 to 17:00 hours = Open2) and the lunch break (12:00 to 12:59 hours = Lunch Break).

### **Prerequisites**

- You are logged on to the WBM with the **Advanced** profile.

### **Step by Step**

- 1) In the navigation bar, click on **Setup**.
- 2) Click in the navigation tree on **Wizards > UC Suite**.
- 3) Click on **Edit** to start the **Contact Center** wizard.

- 4) Click on **Schedule**. All existing schedules are displayed.
- 5) Click on **Add**.
- 6) Define the new mapped rule for times outside business hours.

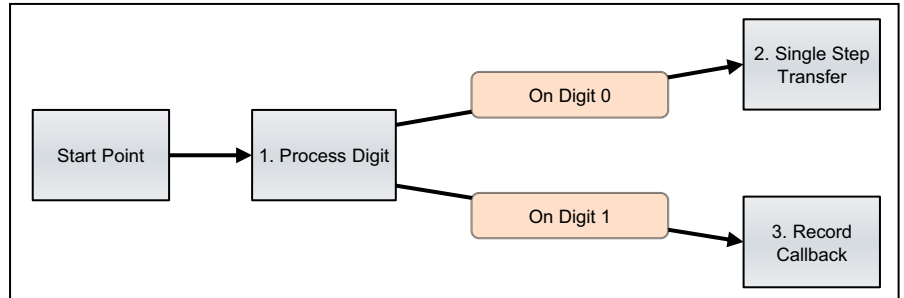

Click in the list of CCV tools on one of the CCV objects contained in the displayed rule and drag it into the Rules Editor. Enter the properties indicated below in the window of the CCV object that appears and confirm this by clicking **OK**. Repeat the procedure for any additional CCV objects. Connect the CCV objects by clicking the right mouse button on the first of the two CCV objects to be joined. Then select the second of the two CCV objects to be connected in the drop-down menu via **Link To**. Repeat the procedure for any additional CCV objects to be joined.

Property	Value
1st. CCV object: <b>Process Digit</b>	
<b>Playlist</b>	Audio file in wav format
<b>Digits Timeout</b>	5
<b>Description</b>	Announcement: "Press digit 0 to ...; Press digit 1 to ..."
2nd. CCV object: <b>Single Step Transfer</b>	
<b>Target Extension</b>	100
<b>Description</b>	Forward to Attendant Console
<b>Process after digits</b>	0
3rd CCV object: <b>Record Callback</b>	
<b>Type</b>	Extensive Callback
<b>Maximum message length</b>	20
<b>Description</b>	Callback request (Agent callback)
<b>Process after digits</b>	1

Click on **Save ...**. Enter *Out of the Office* as the name of the rule and then click **OK**. If the new rule is invalid, it cannot be saved. The invalid CCV object is marked red in the Rule Editor. Close the window confirming that the rule was saved.

Select the rule *Out of the Office* in the **Default CCV** drop-down list.

- 7) Enter the name *Standard Schedule XYZ* in the **Schedule Name** field.

- 8) Click on **Save Schedule**, followed by **OK**.
- 9) Click on **New**, followed by **No**.
- 10) In the **Exceptions** area, click on **Add** to define the first exception for business hours.
- 11) Enter **Open1** in the *Description* field.
- 12) Define the mapped rule for the business hours.

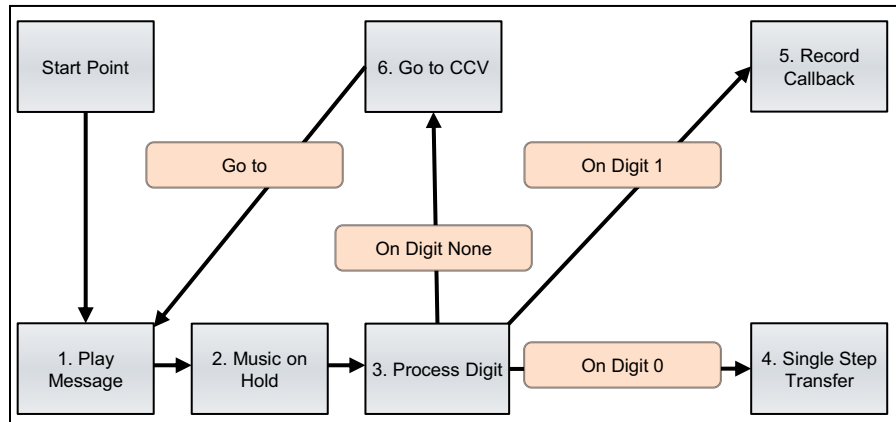

Click in the list of CCV tools on one of the CCV objects contained in the displayed rule and drag it into the Rules Editor. Enter the properties indicated below in the window of the CCV object that appears and confirm this by clicking **OK**. Repeat the procedure for any additional CCV objects. Connect the CCV objects by clicking the right mouse button on the first of the two CCV objects to be joined. Then select the second of the two CCV objects to be connected in the drop-down menu via **Link To**. Repeat the procedure for any additional CCV objects to be joined.

Property	Value
1st. CCV object: <b>Play Message</b>	
<b>File name</b>	Audio file in wav format
<b>Interrupt digits</b>	5
<b>Description</b>	Agent not available announcement
2nd. CCV object: <b>Music on Hold</b>	
<b>Time value</b>	30
<b>Description</b>	Music on Hold for 30 seconds
3rd. CCV object: <b>Process Digit</b>	
<b>Playlist</b>	Audio file in wav format
<b>Digits Timeout</b>	5
<b>Description</b>	Announcement: "Press digit 0 to ...; Press digit 1 to ..."
4th. CCV object <b>Single Step Transfer</b>	

Property		Value
	<b>Target Extension</b>	100
	<b>Description</b>	Forward to Attendant Console
	<b>Process after digits</b>	0
5th. CCV object: <b>Record Callback</b>		
	<b>Type</b>	Extensive Callback
	<b>Maximum message length</b>	20
	<b>Description</b>	Callback request (Agent callback)
	<b>Process after digits</b>	1
6th. CCV object: <b>Go to CCV</b>		
	<b>Target CCV</b>	1. Play Message
	<b>Description</b>	Back to announcement

Click on **Save** .... Enter `Open` as the name for the new rule and then click **OK**. Close the window confirming that the rule was saved.

In the drop-down list, select the rule `Open` for the `Open1` exception.

**13)** Define at what time the exception `Open1` is to apply:

Enable the **Within time range** radio button. Select **08:00** as start time in the `Start Time` list box and **11:59** as end time in the `End Time` list box to define the daily time period.

Click on **Occurs Daily**. Select the weekdays on which the rule is to be applied in the **Select days** window. Then click **Save**.

**14)** Click on the green Save icon.

**15)** In the **Exceptions** area, click on **Add** to define the second exception for business hours.

**16)** Enter `Open2` in the **Description** field.

**17)** In the drop-down list, select the rule `Open` for the `Open2` exception.

**18)** Define at what time the exception `Open2` is to apply:

Enable the **Within time range** radio button. Select **13:00** as start time in the `Start Time` list box and **17:00** as end time in the `End Time` list box to define the daily time period.

Click on **Occurs Daily**. Select the weekdays on which the rule is to be applied in the **Select days** window. Then click **Save**.

**19)** Click on the green Save icon.

**20)** Click on **New**, followed by **No**.

**21)** In the **Exceptions** area, click on **Add** to define the exception for lunch break.

**22)** Enter **Lunch Break** in the `Description` field.

**23)** Define the mapped rule for the lunch break.

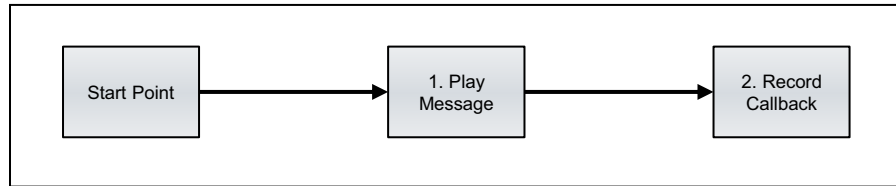

Click in the list of CCV tools on one of the CCV objects contained in the displayed rule and drag it into the Rules Editor. Enter the properties indicated below in the window of the CCV object that appears and confirm this by clicking **OK**. Repeat the procedure for any additional CCV objects. Connect the CCV objects by clicking the right mouse button on the first of the two CCV objects to be joined. Then select the second of the two CCV objects to be connected in the drop-down menu via **Link To**. Repeat the procedure for any additional CCV objects to be joined.

Property		Value
1st. CCV object: <b>Play Message</b>		
<b>File name</b>		Audio file in wav format
<b>Interrupt digits</b>		Select service
<b>Description</b>		Agent not available announcement
2rd CCV object: <b>Record Callback</b>		
<b>Type</b>		Extensive Callback
<b>Maximum message length</b>		20
<b>Description</b>		Callback request (Agent callback)
<b>Process after digits</b>		1

Click on **Save ...**. Enter `Lunch Break` as the name of the rule and then click **OK**. Close the window confirming that the rule was saved.

In the drop-down list, select the rule `Lunch Break` for the Lunch Break exception.

**24)** Define at what time the exception Lunch Break is to apply:

Enable the **Within time range** radio button. Select `12:00` as the start time in the **Start Time** list box and `12:59` as the end time in the **End Time** list box to define the daily time period.

Click on **Occurs Daily**. Select the weekdays on which the rule is to be applied in the **Select days** window. Then click **Save**.

**25)** Click on the green Save icon.

**26)** If you want to test which rule (CCV) of the schedule is executed at a particular point in time, click on **Test Schedule**. Select the desired date and time in the **Date** and **Time** list boxes, respectively. Then click on **Test Schedule**. You will then be shown which rule (CCV) applies on that day and at that time. Click on **Close** to close the **Test Schedule** window.

**27)** Click on **Save Schedule**, followed by **OK**.

**28)** Close the window and confirm the prompt about closing this window with **Yes**.



### 17.6.1.7 How to Add the Standard Schedule Hotline for the Sample Contact Center

You can define the schedule with a rule for free calls (Hotline) for the sample Contact Center of company XYZ with the **Contact Center** wizard.

#### Prerequisites

- You are logged on to the WBM with the **Advanced** profile.

#### Step by Step

- In the navigation bar, click on **Setup**.
- Click in the navigation tree on **Wizards > UC Suite**.
- Click on **Edit** to start the **Contact Center** wizard.
- Click on **Schedule**. All existing schedules are displayed.
- Click on **Add**.
- Define the displayed rule for free calls (Hotline).

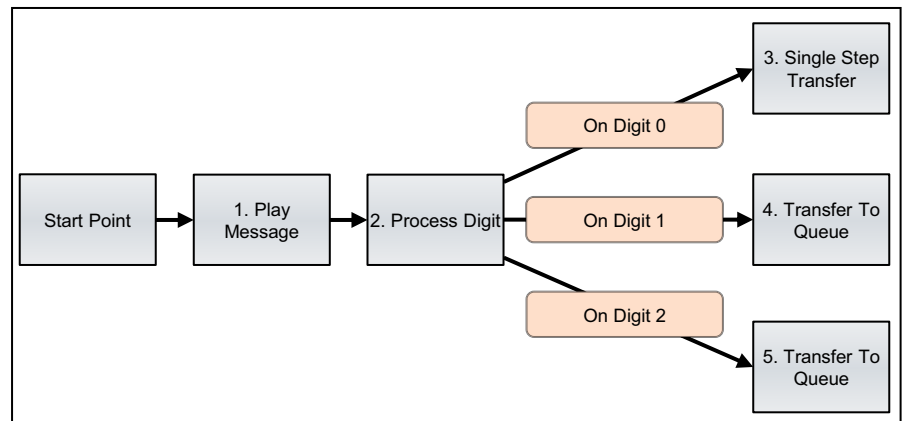

Click in the list of CCV tools on one of the CCV objects contained in the displayed rule and drag it into the Rules Editor. Enter the properties indicated below in the window of the CCV object that appears and confirm this by clicking **OK**. Repeat the procedure for any additional CCV objects. Connect the CCV objects by clicking the right mouse button on the first of the two CCV objects to be joined. Then select the second of the two CCV objects to be connected in the drop-down menu via **Link To**. Repeat the procedure for any additional CCV objects to be joined.

Property	Value
1st. CCV object: <b>Play Message</b>	
<b>File name</b>	Audio file in wav format
<b>Interrupt digits</b>	5
<b>Description</b>	Announcement: Greeting
2nd. CCV object: <b>Process Digit</b>	

Property		Value
	<b>Playlist</b>	Audio file in wav format
	<b>Digits Timeout</b>	5
	<b>Description</b>	Announcement: "Press digit 0 to ...; Press digit 1 to ...
3rd. CCV object: <b>Single Step Transfer</b>		
	<b>Target Extension</b>	100
	<b>Description</b>	Forward to Attendant Console
	<b>Process after digits</b>	0
4th. CCV object <b>Transfer To Queue</b>		
	<b>Queue</b>	440
	<b>Description</b>	Proceed to the Service queue
	<b>Process after digits</b>	1
5th. CCV object <b>Transfer To Queue</b>		
	<b>Queue</b>	444
	<b>Description</b>	Proceed to the Sales queue
	<b>Process after digits</b>	2

Click on **Save ...**. Enter `Hotline` as the name for the rule and then click **OK**. If the new rule is invalid, it cannot be saved. The invalid CCV object is marked red in the Rule Editor. Close the window confirming that the rule was saved. Select the rule **Hotline** in the `Default` CCV drop-down list.

- 7) Enter the name `Standard Schedule Hotline` in the **Schedule Name** field.
- 8) Click on **Save Schedule**, followed by **OK**.
- 9) Close the window and confirm the prompt about closing this window with **Yes**.

### 17.6.1.8 How to Add Queues for the Sample Contact Center

This example shows you how to use the **Contact Center** wizard to configure queues for the sample Contact Center of company XYZ. In the example, one queue is to be configured for the Service Department (with station number 440) and one for the Sales Department (with station number 444). A further queue (Hotline, station number 456) is to be configured for free calls.

### Prerequisites

- The UCD groups **Service**, **Sales** and **Hotline** for the sample Contact Center have been configured.
- The schedules **Standard Schedule XYZ** and **Standard Schedule Hotline** have already been created for the sample Contact Center.
- At least one e-mail account is available for receiving e-mails.
- The sending of e-mails has been configured in the communication system.
- You are logged on to the WBM with the **Advanced** profile.

### Step by Step

- 1) In the navigation bar, click on **Setup**.
- 2) Click in the navigation tree on **Wizards > UC Suite**.
- 3) Click on **Edit** to start the **Contact Center** wizard.
- 4) Click on **Queue**.
- 5) Click on **Add**.
- 6) Click on the **General Settings** tab.
- 7) Enter the name `Service` in the **Queue Name** field.
- 8) In the **Queue Active** drop-down list, select the item **Active**.
- 9) Enter the number **440** in the `Group number` field.
- 10) Select the item **CSP** in the **Phone Switch** drop-down list.
- 11) Select the item **Standard Schedule XYZ** in the **Schedule** drop-down list.
- 12) In the field **Queue Alarm Count**, enter the value `20`, for example.  
If there are more than 20 calls waiting in the queue, the queue symbol at the agent changes from green to orange.
- 13) In the **Queue Alarm Time** field, enter the value `300`, for example.  
Once the waiting time for a queued call specified exceeds 300 seconds, the corresponding item in the list of Contact Center calls for the agents changes to red.
- 14) In the field **Missed Call Timeout**, enter the value `100`, for example, so that any call not answered within 100 seconds is forwarded to the next free agent.
- 15) Enter a number in the **Abandoned Call Threshold** field, e.g., `120`. This causes calls abandoned after 120 seconds to be included in the statistics (of a report).
- 16) Select the check box **Screen Pop Enabled**. A screen pop for displaying and entering customer data will then appear on receiving incoming calls in myAgent.
- 17) Activate the **No Wrapup** option.
- 18) Select the item **Static** in the **Queue depth mode** drop-down list.

- 19) Enter a number in the **WLS** field, e.g., 4.
- 20) Enter a number in the **Queue depth size** field, e.g., 5.
- 21) Click on the **Queue Pilots** tab.
- 22) In the **Inbound Fax Pilots** area, select the appropriate check box or check boxes of the desired pilot/s (phone number/s) so that the faxes are queued.  
  
Faxes to these phone number/s will then be added to the queue and treated as incoming calls.
- 23) Select one of the following options in the **Inbound Email Service**, area so that e-mails are placed in the queue:
  - If you want to set up a new e-mail address, click on **New Email**. The **Edit Queue Email Pilot** window is displayed.  
Enter the designation of the e-mail server to be used for retrieving e-mails in the **Server** field (e.g., `pop3.web.de`).  
Enter the port number of the e-mail server in the **Port** field (e.g., 110, the default port number for POP3).  
Enter the access data for the e-mail server in the **User Name** and **Password** fields.  
Select whether e-mails are to be sent via an SSL (Secure Socket Layer) connection. If you want to use an SSL connection, select the **Use SSL connection** check box. (Note that the port number of the E-mail server may be changed as a result. The default port number for POP3 via SSL = 995). If you do not want to use an SSL connection, clear the **Use SSL connection** check box.  
Click on **OK**. The new e-mail address will then appear in the **Inbound Email Service** area.
  - If you want to edit an existing e-mail address, mark the desired e-mail address and click **Edit Email**. The **Edit Queue Email Pilot** window is displayed.  
Change the required parameters and then lick **OK**.
  - If you want to delete an existing e-mail address, mark the desired e-mail address and click **Remove Email**.
- 24) Click on the **Miscellaneous** tab.
- 25) In the field **Return Email Address**, enter the e-mail address that is to be displayed as the sender's address (for the recipient) when an e-mail is sent by an agent.
- 26) Click on **Save**.
- 27) Repeat steps 5 through 26 to configure the Sales queue. Repeat steps 5 through 17 and step 26 to configure the Hotline queue.

### 17.6.1.9 How to Assign Agents to Queues of the Sample Contact Center

This example shows you how to use the **Contact Center** wizard to assign agents to the queues of the sample Contact Center of company XYZ. In the example,

three agents of the Service queue and three agents of the Sales queue are assigned.

### **Prerequisites**

- The **Service** and **Sales** queues for the sample Contact Center have been set up.
- Six agents were configured for the sample Contact Center.
- You are logged on to the WBM with the **Advanced** profile.

### **Step by Step**

- 1) In the navigation bar, click on **Setup**.
- 2) Click in the navigation tree on **Wizards > UC Suite**.
- 3) Click on **Edit** to start the **Contact Center** wizard.
- 4) Click on **Queue Bindings**. The **Service** and **Sales** queues and the six agents are displayed.
- 5) Click on the queue to which you want to assign an agent. All agents already assigned are displayed.
- 6) Drag the first agent into the **Service** queue. The **Agent Queue Binding** window is then displayed.
- 7) Select one of the following options:
  - If the agent is to receive calls without regard to the load on the **Service** queue, activate the radio button **Primary Agent**.
  - If the agent is to receive calls only when the **Service** queue overflows, activate the radio button **Overflow Agent**.
- 8) If you have selected **Overflow Agent**:
  - a) Enter the time after which incoming calls for an agent should be forwarded in an overflow situation in the **Overflow after calls in queue** field.
  - b) Enter the maximum number of calls in the **Overflow after calls in queue** field. Calls that exceed this maximum number are received by an overflow agent.
- 9) Enter a percentage value for the **Skill Level** of the agent.

Skill levels enable you to control the distribution of calls to agents in the **Service** queue. Agents with higher skill levels are given preference during the call distribution. In cases where all agents have the same skill level, the longest idle agent receives the call.
- 10) Select one of the following options:
  - If the agent is to receive callback requests in the form of voice messages, select the check box **Enable agent callback**.
  - If the agent is to be prevented from receiving callback requests, clear the **Enable agent callback** check box.

- 11) Enter the automatic wrap-up time in seconds for the agent in the **Service** queue in the **Wrap up** field.
- 12) Click on **OK**.
- 13) Repeat steps 5 through 12 to assign all agents to the queues of the sample Contact Center.

## 17.6.2 Configuration Procedure

This section contains an overview of the actions to be performed when configuring the Contact Center.

- **Configure UCD groups**  
The queues of the Contact Center are essentially workgroups that are based on the UCD groups of the communication system. The UCD groups must be defined before the actual configuration of the Contact Center.
- **Configure a fallback solution**  
If the Contact Center is unavailable due to problems (crash, connection down, etc.) the "Uniform Call Distribution (UCD)" feature of the communication system is automatically used. This feature thus serves as the fallback solution for the Contact Center (see [Fallback solution](#)).
- **Configure subscribers as agents**
- **Record individual announcements for the Contact Center**
- **Load individual announcements for the Contact Center**

---

**INFO:** Playing announcements are only possible via trunks. In order to play the announcement the call must come from a trunk or the caller should be monitored by OpenScape Contact Center.

---

- **Add schedules**
- **Add queues**
- **Define target values for the Grade of Service**
- **Define the VIP caller priority**
- **Edit the VIP call list**
- **Define preferred agents**
- **Add Contact Center breaks**
- **Add wrap-up codes**
- **Assigning agents to queues**

### 17.6.2.1 How to Configure UCD Groups for the Contact Center

You can configure UCD groups for the Contact Center with the **UCD** wizard.

### **Prerequisites**

- You are logged on to the WBM with the **Advanced** profile.

### **Step by Step**

- 1) In the navigation bar, click on **Setup**.
- 2) In the navigation tree, click **Wizards > User Telephony**.
- 3) Click **Edit** to start the **UCD** wizard. The list of all possible UCD groups is displayed.
- 4) To configure a UCD group, click **Edit** in the row containing the required UCD group.
- 5) Enter the call number of the new UCD group in the **Call number** field.
- 6) Enter the DID number of the new UCD group in the **Direct inward dialing number** field.
- 7) Enter the name of the UCD group in the **Name** field.
- 8) Click **OK & Next**. The window **Assignment of UCD Agents** is displayed.
- 9) Mark the required UCD agent IDs in the **Selection** and assign them to this UCD group by clicking **Add**.
- 10) Click **OK & Next**. The **Assign stations** window appears.
- 11) Assign the desired stations to all UCD agent IDs.
- 12) Click **OK & Next**. The **Edit announcement/overflow** window appears.
- 13) Click **OK**, since the displayed parameters are not relevant for the configuration of the UCD group.
- 14) If you want to configure further UCD groups for the contact center, repeat steps 4 through 13.
- 15) Click **OK & Next**, followed by **Finish**.

## **17.6.2.2 How to Configure a Subscriber as an Agent**

### **Prerequisites**

- You are logged on to the WBM with the **Advanced** profile.

### **Step by Step**

- 1) In the navigation bar, click on **Setup**.
- 2) Click in the navigation tree on **Wizards > UC Suite**.
- 3) Click on **Edit** to start the **User Directory** wizard.
- 4) Mark the desired station in the user directory and click **Edit**.
- 5) Click in the menu tree on **Personal Details > User Level**.

- 6) Select one of the following options:

If the agent is to be permanently available, select the **Permanently available agent** check box. The agent will then remain available for calls, faxes and e-mails even when he or she does not accept a call, fax or e-mail.

If the agent is not to be permanently available, clear the **Permanently available agent** check box. The agent will then be assigned the status Unavailable when he or she does not accept a call, fax or e-mail.

- 7) Select the authorization level in the **Level** drop-down list.
- 8) Click **Save**.
- 9) If you want to configure another subscriber as an agent, repeat steps 4 through 8.

### 17.6.2.3 How to Record Custom Announcements for the Contact Center

You can record custom announcements for the Contact Center with the **Recorder** wizard.

#### *Prerequisites*

- You are logged on to the WBM with the **Advanced** profile.

#### *Step by Step*

- 1) In the navigation bar, click on **Setup**.
- 2) Click in the navigation tree on **Wizards > UC Suite**.
- 3) Click on **Edit** to start the **Recorder** wizard.
- 4) Select the station number of the phone to be used for recording from the **Extension** drop-down list.
- 5) Click on **Begin**. The selected station number is called.
- 6) Pick up the handset and enter the name for your announcement in the **File Name** field.
- 7) Click on **Record** to start recording the announcement.
- 8) Click on **Stop** as soon as you have finished recording the entire announcement.
- 9) If you want to listen to your new announcement, click on **Play**.
- 10) Click on **Close** to save the announcement.

---

**INFO:** After the announcement has been recorded and saved, it can no longer be deleted. However, it can be overwritten by saving another file with the same file name. For example, saving an audio file named `announcement1.wav` would overwrite any existing `announcement1.wav` file.

---



## 17.6.2.4 How to Load Custom Announcements for the Contact Center

You can load custom announcements for the Contact Center with the **File Upload** wizard.

### *Prerequisites*

- An audio file in .wav format is available with the following properties: mono, audio sample rate 8 kHz, audio sample size 16 bit, frame size 2.
- You are logged on to the WBM with the **Advanced** profile.

### *Step by Step*

- 1) In the navigation bar, click on **Setup**.
- 2) Click in the navigation tree on **Wizards > UC Suite**.
- 3) Click on **Edit** to start the **File Upload** wizard.
- 4) Click on the **Load audio files** tab.
- 5) Select the destination **Attendant Console** in the **Upload Destination** drop-down list.
- 6) Click on **Browse**, navigate to the storage location of the desired audio file and click on **Open**.
- 7) Click on **Upload**.

---

**INFO:** After the audio file is uploaded, it can no longer be deleted. However, it can be overwritten by uploading another file with the same file name. For example, uploading an audio file named `announcement1.wav` would overwrite any existing `announcement1.wav` file.

---

## 17.6.2.5 How to Add a Schedule

### *Prerequisites*

- You are logged on to the WBM with the **Advanced** profile.

### *Step by Step*

- 1) In the navigation bar, click on **Setup**.
- 2) Click in the navigation tree on **Wizards > UC Suite**.
- 3) Click on **Edit** to start the **Contact Center** wizard.
- 4) Click on **Schedule**. All existing schedules are displayed.
- 5) Click on **Add**.
- 6) Select one of the following options for choosing the rule (CCV):

- If you want to assign a previously defined rule to the schedule, select the desired rule in the **Default CCV** drop-down list.
  - If you want to assign a new rule that has not yet been defined to the schedule, proceed as follows:

Click in the list of CCV tools on the desired CCV object and drag it into the Rule Editor. Enter the desired properties in the window of the CCV object that appears and click **OK**. If required, drag further CCV objects into the Rule Editor and define their properties. To connect two CCV objects, right-click with the mouse on the first of the two CCV objects to be connected. Then select the second of the two CCV objects to be connected in the drop-down menu via **Link To**.

If you want to delete a CCV object from the Rule Editor, right-click on that CCV object and select **Remove** in the drop-down menu.

Click on **Save ...**. Enter a name for the new rule and then click **OK**. Close the window confirming that the rule was saved. If the new rule is invalid, it cannot be saved. The invalid CCV object is marked red in the Rule Editor.

Select the new rule just saved from the **Default CCV** drop-down list.
  - If you want to assign a new rule that is based on a previously defined rule to the schedule, proceed as follows:

Select the desired rule from the **Default CCV** drop-down list and click **Edit**. The rule will be displayed in the Rule Editor. Edit the rule.

Click on **Save ...**. Enter a name for the new rule and then click **OK**. Close the window confirming that the rule was saved. If the new rule is invalid, it cannot be saved. The invalid CCV object is marked red in the Rule Editor.

Select the new rule just saved from the **Default CCV** drop-down list.
- 7) If you want to print the rule or send it via an e-mail, you can save the rule as a PDF file. To do this, click **Save printable image**. The Save window appears.
- Enter the name of the file and then select the directory in which the file is to be stored. Click on **Save**.
- 8) Enter the name of the new schedule in the **Schedule Name** field.
- 9) Click on **Save Schedule**, followed by **OK**.
- 10) If you want to assign another rule (CCV) for a specific time period within the schedule, click on **Add** in the **Exceptions** area. The fields for this exception will then be displayed.
- 11) Enter the name of the exception in the **Description** field.
- 12) Select one of the following options for choosing the rule (CCV):
- If you want to assign a previously defined rule to the time period within the schedule, select the desired rule from the drop-down list for this exception.

- If you want to assign a new rule that has not yet been defined to the time period within the schedule, proceed as follows:  
Click on **New** followed by **No**.  
Click in the list of CCV tools on the desired CCV object and drag it into the Rule Editor. Enter the desired properties in the window of the CCV object that appears and click **OK**. If required, drag further CCV objects into the Rule Editor and define their properties. To connect two CCV objects, right-click with the mouse on the first of the two CCV objects to be connected. Then select the second of the two CCV objects to be connected in the drop-down menu via **Link To**.  
If you want to delete a CCV object from the Rule Editor, right-click on that CCV object and select **Remove** in the drop-down menu.  
Click on **Save ...**. Enter a name for the new rule and then click **OK**. Close the window confirming that the rule was saved. If the new rule is invalid, it cannot be saved. The invalid CCV object is marked red in the Rule Editor.  
Select the new rule just saved for this exception from the drop-down list.
- If you want to assign a new rule that is based on a previously defined rule to the time period within the schedule, proceed as follows:  
Select the desired rule from the drop-down list for this exception and click **Edit**. The rule will be displayed in the Rule Editor. Edit the rule.  
Click on **Save ...**. Enter a name for the new rule and then click **OK**. Close the window confirming that the rule was saved. If the new rule is invalid, it cannot be saved. The invalid CCV object is marked red in the Rule Editor.  
Select the new rule just saved for this exception from the drop-down list.

- 13)** Select one of the following options to define at what time the exception is to apply:
- If the exception is to apply for an unlimited time period throughout the year, select the radio button **Within time range**. Select the start and end of the daily time period in the **Start Time** and **End Time** list boxes.  
Click on **Occurs Daily**. Select the weekdays on which the exception is to be applied in the **Select days** window. Then click **Save**.
  - If the exception is to apply for a limited time period during the year, select the radio button **Within time date range**. Enter the starting and ending dates for the time period during the year (format dd.mm.yyyy) in the **Start Date** and **End Date** fields, respectively. Select the start and end of the daily time period in the **Start Time** and **End Time** list boxes. The exception will apply between start date/start time to end date/end time.  
Click on **Occurs Daily**. Select the weekdays on which the exception is to be applied in the **Select days** window. Then click **Save**.
  - If the exception is to apply on holidays, enable the **Holiday Schedules** radio button. Enter the starting and ending dates for the holiday schedule in the **Start Date** and **End Date** fields, respectively. Select the starting and ending times for the holiday schedule in the **Start Time** and **End Time** list boxes, respectively.

---

**INFO:** Holiday schedules have precedence over the other schedules and rules of a queue.

---

- 14) Click on the green Save icon.
- 15) Repeat steps 10 through 14 if you want to define additional exceptions for specific time periods.
- 16) If you want to test which rule (CCV) of the schedule is executed at a particular point in time, click on **Test Schedule**. Select the desired date and time in the **Date** and **Time** list boxes, respectively. Then click on **Test Schedule**. You will then be shown which rule (CCV) applies on that day and at that time. Click on **Close** to close the **Test Schedule** window.
- 17) If you want to assign this schedule to one or more queues, click on **Assigned Queues**. Select the check box(es) for the desired queue(s) in the **Queues** window. Close the **Queues** window.
- 18) Close the window and confirm the prompt about closing this window with **Yes**.

## 17.6.2.6 How to Edit a Schedule

### *Prerequisites*

- You are logged on to the WBM with the **Advanced** profile.

### *Step by Step*

- 1) In the navigation bar, click on **Setup**.
- 2) Click in the navigation tree on **Wizards > UC Suite**.
- 3) Click on **Edit** to start the **Contact Center** wizard.
- 4) Click on **Schedule**. All existing schedules are displayed.
- 5) Mark the schedule to be edited and click **Edit**.
- 6) Change the desired settings for the default CCV:
  - If you want to assign some other rule (CCV) than the one currently displayed in the **Default CCV** drop-down list, select the desired rule in the **Default CCV** list.
  - If you want to edit the rule (CCV) shown in the **Default CCV** list, click **Edit**. The rule will be displayed in the Rule Editor. Edit the rule. Click on **Save ...**. Enter a name for the new rule and then click **OK**. Close the window confirming that the rule was saved.  
Select the new rule just saved from the **Default CCV** drop-down list.
- 7) Click on **Save Schedule**, followed by **OK**.
- 8) Change the desired settings in the **Exceptions** area:
  - If you want to assign another rule (CCV) to a specific time period within the schedule, click **Add**. Select the desired rule in the drop-down list for

this exception. Then use the radio buttons and drop-down lists to specify when this exception is to apply. Enter the name of the exception in the **Description** field. Click on the green Save icon.

- If you want to edit this exception or one of the exceptions displayed, click on the Edit icon of the desired exception. Click on **Edit** to edit the associated rule (CCV). The rule will be displayed in the Rule Editor. Edit the rule. Click on **Save ....** Enter a name for the new rule and then click **OK**. Close the window confirming that the rule was saved.  
Select the new rule just saved from the drop-down list. Then use the radio buttons and drop-down lists to specify when this rule (CCV) is to apply. Click on the green Save icon.
  - If you want to delete this exception or one of the exceptions displayed, click on the red Delete icon of the desired exception.
- 9) If you want to test which rule (CCV) of the schedule is executed at a particular point in time, click on **Test Schedule**. Select the desired date and time in the **Date** and **Time** list boxes, respectively. Then click on **Test Schedule**. You will then be shown which rule (CCV) applies on that day and at that time. Click on **Close** to close the **Test Schedule** window.
  - 10) If you want to assign additional queues to this schedule, click **Assigned Queues**. In the **Queues** window, select the check boxes of the queues to be assigned to the schedule. Clear the check boxes of the queues that are not to be assigned to the schedule. Close the **Queues** window.
  - 11) Close the window and confirm the prompt about closing this window with **Yes**.

### 17.6.2.7 How to Delete a Schedule

#### *Prerequisites*

- You are logged on to the WBM with the **Advanced** profile.

#### *Step by Step*

- 1) In the navigation bar, click on **Setup**.
- 2) Click in the navigation tree on **Wizards > UC Suite**.
- 3) Click on **Edit** to start the **Contact Center** wizard.
- 4) Click on **Schedule**. All available schedules are displayed.
- 5) Mark the desired schedule and click **Remove**, followed by **Yes**.

---

**INFO:** A schedule cannot be deleted as long as it is still assigned to any queue. Before deleting a schedule, its assignment to the queue(s) must be removed.

---

### 17.6.2.8 How to Save a Rule (CCV) as a PDF File

The **Contact Center** wizard enables you to save rules (CCV) as a PDF file. The PDF file can then be typically printed or sent by e-mail.

#### *Prerequisites*

- You are logged on to the WBM with the **Advanced** profile.

#### *Step by Step*

- 1) In the navigation bar, click on **Setup**.
- 2) Click in the navigation tree on **Wizards > UC Suite**.
- 3) Click on **Edit** to start the **Contact Center** wizard.
- 4) Click on **Schedule**. All existing schedules are displayed.
- 5) Select the schedule that contains the desired rule and click **Edit**.
- 6) Select the desired rule from the drop-down list and click **Edit**. The rule will be displayed in the Rule Editor.
- 7) Click on **Save printable image**. The Save window appears.
- 8) Enter the name of the file and then select the directory in which the file is to be stored.
- 9) Click on **Save**.
- 10) Close the window and confirm the prompt about closing this window with **Yes**.

### 17.6.2.9 How to Add a Queue

#### *Prerequisites*

- At least one UCD group has been configured.
- At least one schedule has been set up.
- At least one e-mail account is available for receiving e-mails (if e-mails are to be queued).
- The sending of e-mails has been configured in the communication system (if e-mails are to be sent by agents of the queue).
- You are logged on to the WBM with the **Advanced** profile.

#### *Step by Step*

- 1) In the navigation bar, click on **Setup**.
- 2) Click in the navigation tree on **Wizards > UC Suite**.
- 3) Click on **Edit** to start the **Contact Center** wizard.
- 4) Click on **Queue**.

- 5) Click on **Add**.
- 6) Click on the **General Settings** tab.
- 7) Enter the name of the queue in the **Queue Name** field.

Recommendation: Use the name of one of your configured UCD groups.

---

**INFO:** To ensure that the queue name is displayed fully in a report, you should select short designations and avoid concatenations. Example: Domestic Sales Group 1 (not: DomesticSalesGroup 1)

---

- 8) Select one of the following options for the status of the queue:
  - If you want to activate the new queue, select the item **Active** in the **Queue Active** drop-down list.
  - If you want to deactivate the new queue, select the item **Not active** in the **Queue Active** drop-down list.

The deactivation of a queue leads to the activation of the fallback solution through the associated UCD group. If no agent for the UCD group is logged in, and if no further call forwarding destination has been entered for the UCD group, callers will hear the busy signal.
- 9) Enter the call number of a UCD group that you set up during the basic configuration of the Contact Center in the **Group number** field.
- 10) Select the item **CSP** in the **Phone Switch** drop-down list.
- 11) Select the desired schedule in the **Schedule** drop-down list.
- 12) Enter the alarm threshold value in the **Queue Alarm Count** field.

If the number of calls waiting in the queue exceeds the number specified here, the queue symbol for the agent changes from green to orange.
- 13) Enter the alarm threshold value in seconds in the **Queue Alarm Time** field.

If the waiting time for a queued call specified here is exceeds the time specified here, the corresponding item in the list of Contact Center calls for the agents changes to red.
- 14) Enter the time in seconds after which an unanswered call should be forwarded to the next free agent in the **Missed Call Timeout** field.
- 15) Enter the time in seconds that determines whether or not an abandoned call should be included in the statistics (i.e., in a report) in the **Abandoned Call Threshold** field.

Calls abandoned after the specified time has elapsed are included in the statistics.
- 16) Select one of the following options for the display of screen pops in the myAgent application:

---

**INFO:** Screen pops are needed to accept and execute callbacks and to accept faxes and e-mails.

---

- If you want a screen pop for displaying and entering customer data to appear in myAgent on inbound calls, select the check box **Screen Pop Enabled**.
- If you do not want a screen pop to appear in myAgent on inbound calls, clear the **Screen Pop Enabled** check box.

**17)** Select one of the following options for the wrapup mode:

For queues with wrapup mode, agents can assign their calls to specific categories (orders, complaints, service, etc.) using wrapup codes.

- If you want to set up a queue with the wrapup mode Simple Wrapup, select the **Simple Wrapup** option.
- If you want to set up a queue with the wrapup mode Multiple Wrapup, select the **Multiple Wrapup** option.
- If you want to set up a queue without wrapup mode, select the option **No Wrapup**.

**18)** If you want to change the priority of the queue, click on **Priorities**.

Click on and drag the red dots in the **Queue Priority Over Time** area to the desired positions. The horizontal axis shows the waiting time in the queue, and the vertical axis shows the priority of the selected queue as compared to other queues. If an agent is assigned to multiple queues, the queue priority can be used to define whether calls for a queue with higher priority should be forwarded to this agent with precedence over calls for other queues.

Drag the scroll bars in the **Call Type Priorities** area to the desired position. This defines the priority of the call types within the selected queue. Higher priorities are assigned by moving the scroll bars incrementally to the right.

---

**INFO:** A higher priority should be chosen for voice calls than for other types of calls. Otherwise, waiting callers could be superseded by callbacks, faxes or e-mails.

---

**19)** Select one of the following options for the Queue depth mode:

Queue Depth can be set for each queue individually within the queue configuration dialog

- In case the **Queue depth mode** is set to **Static**, **WLS** and **Queue depth size** parameters can be configured.
- In case the **Queue depth mode** is set to **None**, the **WLS** parameter can be configured nevertheless and affects also the UCD configuration but parameter **Queue depth size** cannot be set.

**20)** Enter the time Waiting Loop Size in the **WLS** field. The **WLS** value which is the number of the voice calls waiting to be connected to an agent, affects



directly the configuration of the parameter Queued Calls of the assigned UCD group.

- 21) If **Queue depth mode** is set to **Static**, enter the quantity of the queue depth in the **Queue depth size** field. The queue depth size is the summary of the waiting loop size (WLS) and the calls on agent.
- 22) Click on the **Queue Pilots** tab.
- 23) If faxes are to be queued, select the appropriate check box or check boxes of the desired pilot/s (phone number/s) in the **Inbound Fax Pilots** area.  
  
Faxes to these phone number/s will then be added to the queue and treated as incoming calls.
- 24) Select one of the following options in the **Inbound Email Service**, area so that e-mails are placed in the queue:
  - If you want to set up a new e-mail address, click on **New Email**. The **Edit Queue Email Pilot** window is displayed.  
Enter the designation of the e-mail server to be used for retrieving e-mails in the **Server** field (e.g., `pop3.web.de`).  
Enter the port number of the e-mail server in the **Port** field (e.g., 110, the default port number for POP3).  
Enter the access data for the e-mail server in the **User Name** and **Password** fields.  
Select whether e-mails are to be sent via an SSL (Secure Socket Layer) connection. If you want to use an SSL connection, select the **Use SSL connection** check box. (Note that the port number of the E-mail server may be changed as a result. The default port number for POP3 via SSL = 995). If you do not want to use an SSL connection, clear the **Use SSL connection** check box.  
Click on **OK**. The new e-mail address will then appear in the **Inbound Email Service** area.
  - If you want to edit an existing e-mail address, mark the desired e-mail address and click **Edit Email**. The **Edit Queue Email Pilot** window is displayed.  
Change the required parameters and then lick **OK**.
  - If you want to delete an existing e-mail address, mark the desired e-mail address and click **Remove Email**.
- 25) Click on the **Miscellaneous** tab.
- 26) In the field **Return Email Address**, enter the e-mail address that is to be displayed as the sender's address (for the recipient) when an e-mail is sent by an agent.
- 27) Select one of the following options for intelligent call routing within the queue:
  - If incoming calls are to be forwarded automatically to the agent who was last connected with the caller, enable the check box **Search for last agent customer if no preferred agent is found**. As a prerequisite, no preferred agent must have been defined for the caller.

- If incoming calls are not to be forwarded automatically to the agent who was last connected with the caller, clear the check box **Search for last agent customer if no preferred agent is found**.

28) Click on **Save**.

## 17.6.2.10 How to Edit a Queue

### *Prerequisites*

- You are logged on to the WBM with the **Advanced** profile.

### *Step by Step*

- 1) In the navigation bar, click on **Setup**.
- 2) Click in the navigation tree on **Wizards > UC Suite**.
- 3) Click on **Edit** to start the **Contact Center** wizard.
- 4) Click on **Queue**.
- 5) Mark the desired queue and click **Edit**.
- 6) Click on the **General Settings** tab.
- 7) Change the desired settings.
- 8) Select one of the following options for the status of the queue:
  - If you want to activate the queue, select the item **Active** in the **Queue Active** drop-down list.
  - If you want to deactivate the queue, select the item **Not active** in the **Queue Active** drop-down list.

The deactivation of a queue leads to the activation of the fallback solution through the associated UCD group. If no agent for the UCD group is logged in, and if no further call forwarding destination has been entered for the UCD group, callers will hear the busy signal.
- 9) Select one of the following options for the display of screen pops in the myAgent application:

---

**INFO:** Screen pops are needed to accept and execute callbacks and to accept faxes and e-mails.

---

- If you want a screen pop for displaying and entering customer data to appear in myAgent on inbound calls, select the check box **Screen Pop Enabled**.
  - If you do not want a screen pop to appear in myAgent on inbound calls, clear the **Screen Pop Enabled** check box.
- 10) Select one of the following options for the wrapup mode:

For queues with wrapup mode, agents can assign their calls to specific categories (orders, complaints, service, etc.) using wrapup codes.

- If you want to set the wrapup mode Simple Wrapup for the queue, select the **Simple Wrapup** option.
- If you want to set the wrapup mode Multiple Wrapup for the queue, select the **Multiple Wrapup** option.
- If you do not want to set any wrapup mode for the queue, select the **No Wrapup** option.

**11)** If you want to change the priority of the queue, click on **Priorities**.

Click on and drag the red dots in the **Queue Priority Over Time** area to the desired positions. The horizontal axis shows the waiting time in the queue, and the vertical axis shows the priority of the selected queue as compared to other queues. If an agent is assigned to multiple queues, the queue priority can be used to define whether calls for a queue with higher priority should be forwarded to this agent with precedence over calls for other queues.

Drag the scroll bars in the **Call Type Priorities** area to the desired position. This defines the priority of the call types within the selected queue. Higher priorities are assigned by moving the scroll bars incrementally to the right.

---

**INFO:** A higher priority should be chosen for voice calls than for other types of calls. Otherwise, waiting callers could be superseded by callbacks, faxes or e-mails.

---

**12)** Click on the **Queue Pilots** tab.

**13)** Select the desired settings in the **Inbound Fax Pilots** area:

- If faxes are to be queued, select the appropriate check box or check boxes of the desired pilot/s (phone number/s) in the **Inbound Fax Pilots** area.
- If faxes are not to be queued, clear the **Inbound Fax Pilots** check box(es).

**14)** Select the desired settings in the **Inbound Email Service** area:

- If you want to set up a new e-mail address, click on **New Email**. The **Edit Queue Email Pilot** window is displayed.

Enter the designation of the e-mail server to be used for retrieving e-mails in the **Server** field (e.g., `pop3.web.de`).

Enter the port number of the e-mail server in the **Port** field (e.g., 110, the default port number for POP3).

Enter the access data for the e-mail server in the **User Name** and **Password** fields.

Select whether e-mails are to be sent via an SSL (Secure Socket Layer) connection. If you want to use an SSL connection, select the **Use SSL connection** check box. (Note that the port number of the E-mail server may be changed as a result. The default port number for POP3 via SSL = 995). If you do not want to use an SSL connection, clear the **Use SSL connection** check box.

Click on **OK**. The new e-mail address will then appear in the **Inbound Email Service** area.

- If you want to edit an existing e-mail address, mark the desired e-mail address and click **Edit Email**. The **Edit Queue Email Pilot** window is displayed.  
Change the required parameters and then lick **OK**.
- If you want to delete an existing e-mail address, mark the desired e-mail address and click **Remove Email**.

**15)** Click on the **Miscellaneous** tab.

**16)** Change the desired settings.

**17)** Click on **Save**.

### 17.6.2.11 How to Activate or Deactivate a Queue

#### *Prerequisites*

- You are logged on to the WBM with the **Advanced** profile.

#### *Step by Step*

- 1)** In the navigation bar, click on **Setup**.
- 2)** Click in the navigation tree on **Wizards > UC Suite**.
- 3)** Click on **Edit** to start the **Contact Center** wizard.
- 4)** Click on **Queue**.
- 5)** Click on **Edit**.
- 6)** Click on the **General Settings** tab.
- 7)** Select one of the following options for the status of the queue:
  - If you want to activate the queue, select the item **Active** in the **Queue Active** drop-down list.
  - If you want to deactivate the queue, select the item **Not active** in the **Queue Active** drop-down list.  
The deactivation of a queue leads to the activation of the fallback solution through the associated UCD group. If no agent for the UCD group is logged in, and if no further call forwarding destination has been entered for the UCD group, callers will hear the busy signal.
- 8)** Click on **Save**.

### 17.6.2.12 How to Configure a Pilot for Incoming Fax Messages in Queues

#### *Prerequisites*

- At least one fax number for receiving faxes is available.
- You are logged into the WBM with the **Expert** profile.

### Step by Step

- 1) Click on **Expert Mode** in the navigation bar.
- 2) In the navigation tree, click on **Telephony Server > Stations**.
- 3) In the menu tree, click on **Stations > UC Applications > Contact Center Fax**. The logical port numbers intended for fax boxes are displayed.
- 4) Click on the desired port number in the menu tree.
- 5) Click the **Edit Station Parameters** tab.
- 6) Enter the call number of the new pilot for incoming fax messages in the **Call Number** field.
- 7) Enter the name of the new pilot for incoming fax messages in the **Name** field.
- 8) Enter the direct inward dialing number of the new pilot for incoming fax messages in the **Direct inward dialing number** field.
- 9) Click **Apply** followed by **OK**.

The pilot for incoming fax messages can now be activated for the desired queue.

## 17.6.2.13 How to Define Target Values for the Grade Of Service

### Prerequisites

- You are logged on to the WBM with the **Advanced** profile.

### Step by Step

- 1) In the navigation bar, click on **Setup**.
- 2) Click in the navigation tree on **Wizards > UC Suite**.
- 3) Click on **Edit** to start the **Contact Center** wizard.
- 4) Click on **Grade of Service**.
- 5) Mark the desired queue and click **Edit**.
- 6) Click on and drag the red dots to the desired positions.

The horizontal axis shows the waiting time in the queue in intervals of 10 seconds, and the vertical axis shows the target value for the Grade Of Service as percentage values.

This enables you to specify the target values for quality of switching in the queue. Quality assessments can then be made by comparing these target values with the actual waiting times for callers in the queue.

- 7) Click on **Save**.

## 17.6.2.14 How to Define the VIP Caller Priority

### *Prerequisites*

- You are logged on to the WBM with the **Advanced** profile.

### *Step by Step*

- 1) In the navigation bar, click on **Setup**.
- 2) Click in the navigation tree on **Wizards > UC Suite**.
- 3) Click on **Edit** to start the **Contact Center** wizard.
- 4) Click on **VIP Caller Priorities**.
- 5) Mark the desired queue and click **Edit**.
- 6) Click on and drag the red dots to the desired positions.

This defines the priority of normal callers as opposed to VIP callers.

The horizontal axis shows the waiting time in the queue in intervals of 30 seconds, and the vertical axis shows the priority of normal callers who are not registered in the VIP call list directory.

For example, you can set the red dots so that a priority of 100 percent is reached after 180 seconds. In this case, normal callers will be treated with the same priority as VIP callers only after 180 seconds. Earlier incoming calls from VIP callers are given prioritized treatment in the queue.

Alternatively, the values for individual waiting time intervals can also be entered in the input fields on the right next to the graph.

- 7) Click on **Save**.

## 17.6.2.15 How to Edit the VIP Call List

### *Prerequisites*

- The callers to be placed on the VIP Call List are in the external directory.
- You are logged on to the WBM with the **Advanced** profile.

### *Step by Step*

- 1) In the navigation bar, click on **Setup**.
- 2) Click in the navigation tree on **Wizards > UC Suite**.
- 3) Click on **Edit** to start the **Contact Center** wizard.
- 4) Click on **VIP Call List**.
- 5) Mark the desired queue and click **Edit**.
- 6) Select one of the following options:

- If you want to add a caller to the VIP Call List, click **Add** in the upper part of the window. Select the desired entry. Define the priority of this VIP caller as opposed to other VIP callers by dragging the scroll bar to the desired position. Higher priorities are assigned by moving the scroll bars incrementally to the right.
- If you want to add a call number pattern to the VIP Call List, click **Add** in the lower part of the window. Enter the desired call number pattern (e.g., 089 7577\*) in the Pattern field. Define the priority of all VIP callers with this call number pattern as opposed to other VIP callers by dragging the scroll bar to the desired position. Higher priorities are assigned by moving the scroll bars incrementally to the right.

It is not possible to enter call number patterns in the canonical call number format. The use of shortcut characters for country codes (for example +49 instead 0049) is likewise not possible. Call number patterns must always be specified without the CO access code.

Example of a call number pattern: 089 7577\* (089 = area code for Munich, 7577 = PABX number of a company, \* = wildcard for any number). By entering this call number pattern in the VIP call list, all callers from Munich, whose telephone number begins with 7577, are given priority.

The following characters can be used as wildcards (placeholders) in a call number pattern:

\* = wildcard for any number

? = wildcard for any digit

- If you want to edit an item in the VIP call list, mark the desired entry and click **Edit**. Change the desired settings.
- If you want to remove an entry from the VIP call list, mark the desired entry and click **Remove**.

7) Click on **Save**.

## 17.6.2.16 How to Define Preferred Agents

### *Prerequisites*

- You are logged on to the WBM with the **Advanced** profile.

### *Step by Step*

- 1) In the navigation bar, click on **Setup**.
- 2) Click in the navigation tree on **Wizards > UC Suite**.
- 3) Click on **Edit** to start the **Contact Center** wizard.
- 4) Click on **Preferred Agents**.
- 5) Mark the desired queue and click **Edit**.
- 6) Mark the desired caller in the **Customers** area.

- 7) Click on **Add Agent**.
- 8) Select the desired agent and click **OK**.  
The name of the selected agent is then shown in the **Preferred Agents** area.
- 9) If you want to define another agent as a preferred agent, repeat steps 7 and 8.
- 10) Define the priority of the preferred agent if multiple preferred agents were defined. You have the following options:
  - If you want to assign a higher priority, mark the desired agent and move that agent to a higher position in the list by using the **Move Up** button.
  - If you want to assign a lower priority, mark the desired agent and move that agent to a lower position in the list by using the **Move Down** button.

### 17.6.2.17 How to Delete Preferred Agents

#### *Prerequisites*

- You are logged on to the WBM with the **Advanced** profile.

#### *Step by Step*

- 1) In the navigation bar, click on **Setup**.
- 2) Click in the navigation tree on **Wizards > UC Suite**.
- 3) Click on **Edit** to start the **Contact Center** wizard.
- 4) Click on **Preferred Agents**.
- 5) Mark the desired queue and click **Edit**.
- 6) Mark the agent to be deleted in the **Preferred Agents** area.
- 7) Click on **Remove Agent**.

### 17.6.2.18 How to Add a Contact Center Break

#### *Prerequisites*

- You are logged on to the WBM with the **Advanced** profile.

#### *Step by Step*

- 1) In the navigation bar, click on **Setup**.
- 2) Click in the navigation tree on **Wizards > UC Suite**.
- 3) Click on **Edit** to start the **Contact Center** wizard.
- 4) Click on **Contact Center Breaks**.
- 5) Click on **Add**.
- 6) Enter the name of the Contact Center break in the **Name** field.



- 7) Enter the duration of the Contact Center break in minutes in the **Duration (Minutes)** field.
- 8) Select the **Active** check box to activate the new Contact Center break system-wide.
- 9) Click on **Save**.
- 10) If you want to add another Contact Center break, repeat steps 5 through 9.

### 17.6.2.19 How to Edit a Contact Center Break

#### *Prerequisites*

- You are logged on to the WBM with the **Advanced** profile.

#### *Step by Step*

- 1) In the navigation bar, click on **Setup**.
- 2) Click in the navigation tree on **Wizards > UC Suite**.
- 3) Click on **Edit** to start the **Contact Center** wizard.
- 4) Click on **Contact Center Breaks**.
- 5) Mark the desired Contact Center Break and click **Edit**.
- 6) Change the required parameters.
- 7) Select one of the following options:
  - If the Contact Center break should be available to agents, select the **Active** check box.
  - If the Contact Center break should not be available to agents, clear the **Active** check box.
- 8) Click on **Save**.

### 17.6.2.20 How to Delete a Contact Center Break

#### *Prerequisites*

- You are logged on to the WBM with the **Advanced** profile.

#### *Step by Step*

- 1) In the navigation bar, click on **Setup**.
- 2) Click in the navigation tree on **Wizards > UC Suite**.
- 3) Click on **Edit** to start the **Contact Center** wizard.
- 4) Click on **Contact Center Breaks**.
- 5) Mark the desired Contact Center Break and click **Delete**.

### 17.6.2.21 How to Add a Wrapup Reason for a "Simple Wrapup"

#### *Prerequisites*

- You are logged on to the WBM with the **Advanced** profile.

#### *Step by Step*

- 1) In the navigation bar, click on **Setup**.
- 2) Click in the navigation tree on **Wizards > UC Suite**.
- 3) Click on **Edit** to start the **Contact Center** wizard.
- 4) Click on **Contact Center Wrapup Codes**. All queues for which a wrapup code for "Simple Wrapup" were defined are displayed.
- 5) Click on **Add**.
- 6) Select the queue for which you want to add a wrapup reason in the **Queue** drop-down list.
- 7) Enter a designation for the new wrapup reason in the **Description** field.
- 8) Click on **Save**.
- 9) If you want to add another wrapup reason, repeat steps 5 through 8.

### 17.6.2.22 How to Edit a Wrapup Reason for a "Simple Wrapup"

#### *Prerequisites*

- You are logged on to the WBM with the **Advanced** profile.

#### *Step by Step*

- 1) In the navigation bar, click on **Setup**.
- 2) Click in the navigation tree on **Wizards > UC Suite**.
- 3) Click on **Edit** to start the **Contact Center** wizard.
- 4) Click on **Contact Center Wrapup Codes**. All queues for which a wrapup code for "Simple Wrapup" were defined are displayed.
- 5) Mark the desired entry and click **Edit**.
- 6) If you want to assign the wrapup reason to another queue, select the new queue in the **Queue** drop-down list.
- 7) If you want to change the designation of the wrapup reason, enter the new designation in the **Description** field.
- 8) Click on **Save**.

### 17.6.2.23 How to Delete a Wrapup Reason for a "Simple Wrapup"

#### *Prerequisites*

- You are logged on to the WBM with the **Advanced** profile.

#### *Step by Step*

- 1) In the navigation bar, click on **Setup**.
- 2) Click in the navigation tree on **Wizards > UC Suite**.
- 3) Click on **Edit** to start the **Contact Center** wizard.
- 4) Click on **Contact Center Wrapup Codes**. All queues for which a wrapup code for "Simple Wrapup" were defined are displayed.
- 5) Mark the desired entry and click **Clear**.

### 17.6.2.24 How to Add a Wrapup Reason for a "Multiple Wrapup"

#### *Prerequisites*

- You are logged on to the WBM with the **Advanced** profile.

#### *Step by Step*

- 1) In the navigation bar, click on **Setup**.
- 2) Click in the navigation tree on **Wizards > UC Suite**.
- 3) Click on **Edit** to start the **Contact Center** wizard.
- 4) Click on **Multi-Wrapup Code**.
- 5) Select the desired queue in the **Contact Center Queue** drop-down list. The groups and subgroups already defined for this queue are displayed.
- 6) If you want to combine the new wrapup reason in a group with other wrapup reason, select one of the following options:
  - If you want to assign the new wrapup reason to an existing group or subgroup, select the desired group or subgroup and click **Add Item**. Enter a designation for the new wrapup reason in the **New Wrapup Item** field and click **OK**.
  - If you want to assign the new wrapup reason to a new group, click **Add Group**. Enter a designation for the new group in the **Group Name** field and click **OK**.  
Select the new group and click **Add Item**. Enter a designation for the new wrapup reason in the **New Wrapup Item** field and click **OK**.

- If you want to assign the new wrapup reason to a new subgroup, select the desired group and click **Add Group**. Enter a designation for the new subgroup in the **Group Name** field and click **OK**.  
Select the new subgroup and click **Add Item**. Enter a designation for the new wrapup reason in the **New Wrapup Item** field and click **OK**.
- 7) If you want to add another wrapup reason, repeat steps 5 and 6.

### 17.6.2.25 How to Edit a Wrapup Reason for a "Multiple Wrapup"

#### *Prerequisites*

- You are logged on to the WBM with the **Advanced** profile.

#### *Step by Step*

- 1) In the navigation bar, click on **Setup**.
- 2) Click in the navigation tree on **Wizards > UC Suite**.
- 3) Click on **Edit** to start the **Contact Center** wizard.
- 4) Click on **Multi-Wrapup Code**.
- 5) Select the desired queue in the **Contact Center Queue** drop-down list. The groups and subgroups already defined for this queue are displayed.
- 6) Mark the group or subgroup to which the wrapup reason to be edited is assigned. All wrapup reasons (items) assigned to this group will be displayed.
- 7) Mark the wrapup reason to be edited and click on **Rename Item**.
- 8) Enter a new designation for the wrapup reason in the **Rename Wrapup Code** field and click **OK**.
- 9) If you want to change the designation of the group or subgroup, click on **Rename Group**.
- 10) Enter a new designation for the group or subgroup in the **Group Name** field and click **OK**.

### 17.6.2.26 How to Delete a Wrapup Reason for a "Multiple Wrapup"

#### *Prerequisites*

- You are logged on to the WBM with the **Advanced** profile.

#### *Step by Step*

- 1) In the navigation bar, click on **Setup**.
- 2) Click in the navigation tree on **Wizards > UC Suite**.
- 3) Click on **Edit** to start the **Contact Center** wizard.
- 4) Click on **Multi-Wrapup Code**.

- 5) Select the desired queue in the **Contact Center Queue** drop-down list. The groups and subgroups already defined for this queue are displayed.
- 6) Mark the group or subgroup to which the wrapup reason to be deleted is assigned. All wrapup reasons (items) assigned to this group will be displayed.
- 7) Mark the wrapup reason to be deleted and click on **Remove Item**.
- 8) If you want to delete the group or subgroup, click on **Remove Group**.

### 17.6.2.27 How to Assign an Agent to a Queue

You can assign agents to one or more queues with the **Contact Center** wizard.

#### *Prerequisites*

- You are logged on to the WBM with the **Advanced** profile.

#### *Step by Step*

- 1) In the navigation bar, click on **Setup**.
- 2) Click in the navigation tree on **Wizards > UC Suite**.
- 3) Click on **Edit** to start the **Contact Center** wizard.
- 4) Click on **Queue Bindings**. All existing queues and agents will be displayed.
- 5) Click on the queue to which you want to assign an agent. All agents already assigned are displayed.
- 6) Drag the appropriate agents into the desired queue. The **Agent Queue Binding** window is then displayed.
- 7) Select one of the following options:
  - If the agent is to receive calls without regard to the load on the queue, activate the radio button **Primary Agent**.
  - If the agent is to receive calls only when the queue overflows, activate the radio button **Overflow Agent**.
- 8) If you have selected **Overflow Agent**:
  - a) Enter the time after which incoming calls for an agent should be forwarded in an overflow situation in the **Overflow after calls in queue** field.
  - b) Enter the maximum number of calls in the **Overflow after calls in queue** field. Calls that exceed this maximum number are received by an overflow agent.
- 9) Enter a percentage value for the **Skill Level** of the agent.

Skill levels enable you to control the distribution of calls to agents in a queue. Agents with higher skill levels are given preference during the call distribution. In cases where all agents have the same skill level, the longest idle agent receives the call.
- 10) Select one of the following options:

- If the agent is to receive callback requests in the form of voice messages, select the check box **Enable agent callback**.
  - If the agent is to be prevented from receiving callback requests, clear the **Enable agent callback** check box.
- 11) Enter the automatic wrapup time in seconds for the agent in this queue in the **Wrap up** field.
  - 12) Click on **OK**.
  - 13) If you want to assign further agents to the queues, repeat steps 5 through 12.

### 17.6.2.28 How to Remove an Agent from the Queue

You can remove agents from one or more queues with the **Contact Center** wizard.

#### *Prerequisites*

- You are logged on to the WBM with the **Advanced** profile.

#### *Step by Step*

- 1) In the navigation bar, click on **Setup**.
- 2) Click in the navigation tree on **Wizards > UC Suite**.
- 3) Click on **Edit** to start the **Contact Center** wizard.
- 4) Click on **Queue Bindings**. All existing queues and agents will be displayed.
- 5) Double-click on the queue from which you want to remove an agent. All agents already assigned are displayed.
- 6) Right-click on the desired agent and select **Remove** from the drop-down menu.
- 7) If you want to remove further agents from queues, repeat steps 5 and 6.

## 17.7 Notes on Using the Contact Center

This section contains information about some special aspects and possible restrictions to be observed when using the Contact Center.

### 17.7.1 Restrictions on Operating the Contact Center

The operation of the Contact Center is subject to certain conditions. In addition, there are some restrictions on the use of system features by agents.

### Conditions for the Operation of the Contact Center

The following conditions for the operation of the Contact Center must be taken into account:

- **Trunks**  
The Contact Center does not support analog trunks (MSI). All external connections of the Contact Center must be made via ISDN or IP telephony. It should be noted that the integration of IP telephony is only possible through certified Internet Telephony Service Providers (ITSPs).
- **Networking**  
In a networked scenario, all agents must be connected to the communication system in which the Contact Center is configured.
- **Agent telephones**  
Agents can use all system telephones (IP phones (HFA) such as OpenStage 40, for example, or U<sub>P0/E</sub> phones such as OpenStage 40 T) and DECT telephones. Note that only the DECT telephones that are currently released for operation with OpenScape Business Cordless may be used.  
It is not possible to use analog, ISDN and SIP telephones here.  
Agents are not allowed to be members of a group (Group Call, Hunt Group) or a MULAP. This restriction also applies to system features used in combination with MULAPs, i.e., Team Configuration (Team Group), Executive/Secretary (Top Group) and Mobility Entry.
- **myAgent**  
myAgent should not be used simultaneously with other UC clients, since mutual interference with the presence status cannot be excluded (see [Notes on Using myAgent and UC Suite Clients Simultaneously](#)). During normal operation of the Contact Center, agents use only myAgent to change their status (logged in, logged out, available, etc.).
- **Connecting applications via the CSTA interface**  
It is possible to connect applications via the CSTA interface, provided the following conditions are met:
  - The application should not produce any significant additional load on the CSTA interface.  
Consequently, the connection of unified communications or call distribution solutions, CTI power dialers or even CTI solutions with many intensively used individual CTI clients is not allowed.
  - The application must not control any agent telephones via the CSTA interface or set up any call forwarding for the agent telephones.  
Consequently, the connection of CTI applications for agents, rule assistants or personal assistants is not allowed.

The connection of TAPI 120/170 has been basically approved. For the load of the communication system, the same conditions as for the connection of other applications via the CSTA interface apply. In connection with the Contact Center, TAPI 120/170 should preferably be used to connect CRM (Customer Relationship Management) or ERP (Enterprise Resource Planning) systems, provided they support TAPI.

## **Restrictions on Using System Features**

The following system features are not available to agents or are subject to restrictions. These features are, however, not mandatory for agents, since the allocation of calls is handled automatically by the Contact Center. The allocation depends on the set rules and the availability of agents.

- **Locked Features**

The activation of system features via myAgent and the associated agent telephone is not supported for the available agents of the Contact Center. Agents can activate system features only via myAgent.

The following system features are therefore not supported in conjunction with myAgent:

- Call waiting
- Second call
- Parking
- Group Call
- Do Not Disturb (for logged in agents)
- Intrusion on an agent call (exception: agents with the authorization level of a Supervisor or Administrator)
- Features that affect call routing and active call connections

- **Features that affect call routing**

The following features could potentially change the call routing in the contact center and should therefore not be executed by agents.

- Call forwarding  
If a logged in agent activates call forwarding, a logout occurs.  
Call forwarding is disabled as soon as an agent logs into a queue.
- Do Not Disturb  
If a logged in agent activates Do Not Disturb via a UC client, an automatic logout occurs.  
Do not Disturb is disabled as soon as an agent logs into a queue.
- Relocate  
Relocating a telephone changes the logical assignment of the station numbers. The new station number assignment is only transmitted after restarting the Contact Center.
- Night service  
When setting up a night service in the communication system, it must be ensured that the configurations of the Contact Center-related parameters (agents, queues, etc.) for the day and night service are identical.

- **Features that affect reports**

Executing the following features from an agent telephone can lead to a distortion of the information in reports:

- Call pickup of Contact Center calls by non-agents
- Call transfers (e.g., via the Direct Station Select (DSS) key) of Contact Center calls to non-agents
- Conferencing
- Toggle/Connect
- Parking



---

**INFO:** The "Consultation Hold" feature is transparent for the presentation of Contact Center calls in reports and can be used by agents, regardless of the consultation destination.

---

- Roles and functions not relevant for agents  
The following functions are not relevant, since the "Call Waiting" feature (also called "camp on") is blocked for agents.
  - Attendant Console
  - Hotline destination

## 17.8 Notes on the Use of DECT Phones

DECT telephones can be used as phones for contact center agents. However, the differences in the operating procedure as compared to corded phones must be taken into account.

### Prerequisites for the Use of DECT Phones

- Only the DECT telephones that are currently released for operation with HiPath Cordless Office and OpenScape Business Cordless may be used.
- The area within which the contact center agents move about must provide a complete wireless coverage.
- The number of base stations must be such that enough B-channels are available for the DECT telephones of the contact center agents.
- As far as possible, a contact center agent should not leave the wireless range while logged into a queue of the contact center.

### Differences in the Operating Procedure as Compared to Corded Phones

- Logging into a queue of the contact center is only possible through myAgent.
- No messages such as **Available** or **Break**, for example, appear in the display of the DECT telephone.
- The control of a DECT telephone via myAgent (e.g., via the **Telephony** area of the myAgent main window or the screen pop of the incoming myAgent call) is not possible.
- Incoming calls can only be accepted via the DECT telephone.
- Outbound calls must be initiated via the DECT telephone.

Aspects to be considered when using DECT phones:

- **Search time**  
For an incoming call, the time required to find the DECT telephone may take several seconds (at worst up to 20 seconds) before a call is signaled on the DECT telephone. During the search time, the caller hears the ringing tone. The contact center evaluates this time as "pickup time". The actual pickup time by a contact center agent thus consists of the search time and the alert time (i.e., time until the call is answered).  
If a contact center agent leaves the wireless range with his or her DECT telephone, this may result in longer search times.
- **DECT telephone cannot be found**  
If a contact center call exceeds the prescribed time for a call to be answered by the agent (e.g., because the contact center agent is out of range), the agent is automatically logged out of the queue or queues involved. Logging in again is only possible through myAgent.

## 17.9 Reports

Reports are used to determine the current status of the Contact Center and to analyze the strengths and weaknesses of its associated components. This makes it possible to optimize the Contact Center configuration, for example, and to thus use the Contact Center resources more efficiently. The Contact Center provides users with real-time reports as well as historical reports.

### Real-time Reports

Real-time reports are continuously updated. They provide important information such as details on agent utilization, the grade of service, abandon rates and average processing times. Using these continually updated and filterable caller lists, the progress of a customer contact can be examined in stages. In addition, the activities of all agents can be reviewed. This information can be used for training purposes, for example, and for contact analysis and wrap-up activities.

Agents with the authorization level of a Supervisor or Administrator can be acoustically and visually informed when definable operating parameters are exceeded. Appropriate thresholds for each queue can be defined individually.

### Historical Reports

By selecting data elements and user-specific report parameters, historical reports can be set up quickly and retrieved in graphic or tabular form.

Using the myAgent application, more than 20 predefined report templates can be used for standard reports.

The optionally available myReports application expands the options for creating historical reports with over 100 predefined report templates. The report generation can be individually scheduled, and the prepared reports can be automatically sent at scheduled times in standard export formats to predefined e-mail addresses or stored at a location configured by the myReports administrator.

---

**INFO:** Reports based on the call history stored in the communication system. The maximum retention period for the call history is 365 days (default setting). An administrator with the **Expert** profile can set the retention period for the call history on a system-wide basis.

Example: The retention period was set to 100 days. This means that only data that is up to 100 days old can be used for the preparation of reports.

---

### Data Protection

If the myReports administrator enabled data protection when configuring myReports, the last four digits of the phone numbers (CLI column) will be replaced by \*\*\*\* in all relevant reports.

If the subscriber has flagged his or her private number, mobile number, external number 1 and/or external number 2 as invisible, these phone numbers will not be displayed in all relevant reports.

## 17.9.1 Predefined Report Templates

myReports provides more than 100 predefined report templates for creating reports.

These templates are classified by subject area and assigned to the following report groups:

- **Agent Activity**
- **Agents**
- **CLI**
- **Call History**
- **Calls**
- **Fax / E-Mail**
- **Other**
- **Performance**
- **Queues**
- **User Presence Status**
- **Wrap-up Codes**

## 18 Mobility

OpenScope Business provides integrated mobility solutions for any business. This typically includes the integration of mobile phones/smartphones, the usage of Cordless/DECT and WLAN phones, etc., down to Desk Sharing and teleworking. Mobility includes Mobility on the road, Mobility in the office and Mobility at home.

### 18.1 Integrated Mobility Solution

The mobility solutions integrated in the communication system provide efficient communication everywhere and with a wide variety of endpoints.

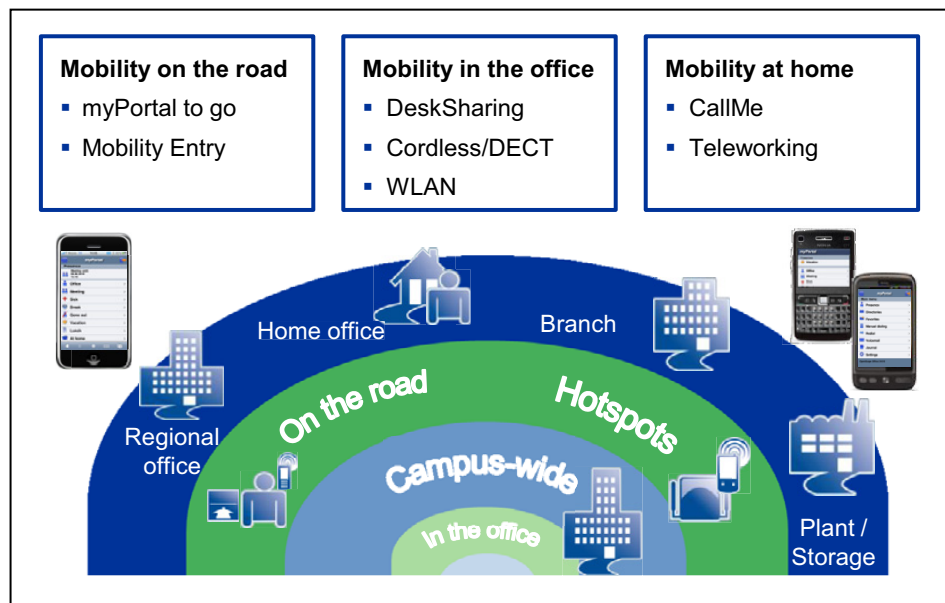

### 18.2 Mobility on the Road

Mobility on the road is achieved through the integration of mobile phones via myPortal to go or Mobility Entry. The One Number Service enables a subscriber to be reached through a single phone number worldwide. Furthermore, with dual-mode telephony, additional cost savings can be achieved if the subscriber is within range of a WLAN.

Mobility on the road is the combination of:

- Office phone and smartphone (myPortal to go)
  - Availability under one number (One Number Service)
  - Control of features via the web client
  - UC features such as control of the presence status

- Office phone and mobile phone (Mobility Entry)
  - Availability under one number (One Number Service)
  - Control of features via DTMF codes

In addition to the combination of mobile phone and office phone, it is also possible to configure a mobile phone alone (i.e., without a parallel office phone) to be reached under a land-line number.

Full functionality is achieved with system telephones (HFA). SIP phones can be used with restrictions.

## 18.2.1 myPortal to go

myPortal to go is a powerful unified communications application for smartphones and tablet PCs which provides access to the unified communications features of the communication system. Besides convenient dialing aids via phone directories and favorites, and information on the presence status of colleagues, it can, for example, also be used to access voicemails.

myPortal to go is available in three variants:

- As a Mobile UC App for the Android operating system (version 4.0 or higher)
- As a Mobile UC App for the Apple iOS operating system (version 6 or higher)
- as a Web Edition for mobile web browsers with HTML5 support, e.g., for the Windows Phone (version 8.0 or higher) or BlackBerry (version 10 or higher) operating systems:

```
http://<IP address of the communication system>:8801
```

```
https://<IP address of the communication system>:8802
```

For security reasons it is recommended that only https be used. This requires port forwarding to be set up in the router from external TCP/443 to internal TCP/8802.

---

**INFO:** Please note that by using myPortal to go Web Edition with Desk phone operating mode, telephony is not possible from the client. You can place calls but payload will go through the desk phone which is connected.

---

myPortal to go can be used both on pure GSM mobile phones as well as dual-mode phones. In order to use myPortal to go, a mobile phone contract with data option (flat rate recommended) is required.

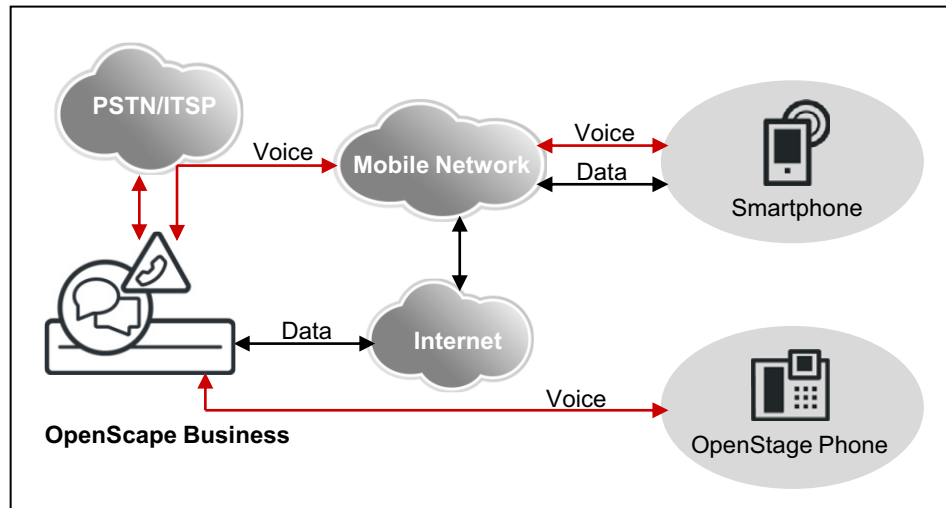

Apart from a few exceptions (e.g., access to contact details in the mobile phone), the scope of features is identical in all variants.

myPortal to go supports the following features:

- Presence status
- Status-based call forwarding
- CallMe service (only with UC Suite)
- Directories
- Favorites List
- Journal
- Search by phone number and name
- Call Functions
- One Number Service (ONS)
- Voicemail
- Text messages

CTI Features During a Call:

- Consultation
- Toggle/Connect
- Attendant
- Conferencing
- Disconnect

myPortal to go can be used with both the UC solutions, UC Smart and UC Suite. Depending on the UC solution and the licenses assigned to you, the scope of the available features may vary slightly.

myPortal to go supports the following operating modes:

- **Mobility:**  
Unrestricted access to the telephony and UC features, regardless of location (including One Number Service).

- Desk phone:  
Use of UC features and as a convenient dialing aid for the office phone (without One Number Service).

Other features can be used with the UC clients (e.g., myPortal Smart or myPortal for Desktop)

myPortal go establishes an encrypted connection (https) to the OpenScape Business UC Server. If the connection is interrupted (offline mode), you can still select and dial cached entries from the journal and the favorites list via GSM and perform GSM dialing manually.

---

**INFO:** For supporting mobility, myPortal to go has to be firstly registered as VoIP (HFA) user so that the Openscape Business System side relevant port to become active.

---

### Dialing mode of myPortal to go

Smartphone users can choose between different dialing modes for outbound calls, depending on which operating mode is set as the intended use.

- Call through (only in the Mobility mode)
- Preferred callback (only in the Mobility mode)
- Associated dialing (only in the Mobility mode)  
myPortal to go controls the connection setup for the desk phone at the workplace. If a SIP phone or a SIP softclient is controlled via associated dialing, some CTI features such as consultation holds and conferencing are not available.

## 18.2.1.1 Prerequisites for myPortal to go

In order to use myPortal to go, the smartphone must be equipped with the appropriate hardware and software.

The following requirements apply:

- For myPortal to go as Mobile UC App: Android operating system (version 4.4 or higher) or Apple iOS (version 6 or higher)
- For myPortal to go as Web Edition: Mobile web browser with HTML5 support, e.g., for the Windows Phone (version 8.1 or higher) or BlackBerry (version 10 or higher) operating systems. Web browsers without TLS 1.2 support are not supported anymore.

To enable access, port forwarding must be set up in the router from external TCP/443 to internal TCP/8802 (https) or internal TCP/8801 (http). For security reasons it is recommended that only https be used.

- Touch screen (recommended for ease of use)
- Display resolution for smartphones: at least 240 pixels \* 320 pixels (recommended: 320 pixels \* 480 pixels or higher)
- Display resolution for tablet PCs: at least 800 pixels \* 480 pixels (recommended: 1024 pixels \* 600 pixels or higher)

- Internet access
- Support for the simultaneous transmission of voice and data through mobile phones and the mobile network
- 3G data connection, for example, EDGE, UMTS, HSDPA (recommended for smooth service). GPRS can lead to slow page rendering.  
Alternatively: a pure WLAN connection with a SIP client for telephony.
- Flat rate data plan (recommended for cost reasons), since data volumes of several 100 MB per month may be involved, depending on usage.

The mobile UC app can be downloaded free of charge from the Google Play Store or the Apple App Store.

Depending on which device and operating system is used, the ease of use or function may be affected. Support is only provided if a reported problem with a reference device can be reproduced. For more information on reference devices, browsers and operating systems, refer to the Release Notes and the Experts wiki at [http://wiki.unify.com/wiki/myPortal\\_to\\_go](http://wiki.unify.com/wiki/myPortal_to_go).

## 18.2.2 Mobility Entry

Mobility Entry enables the integration of mobile phones. This provides subscribers with access to certain system features via mobile phones.

Mobility Entry enables subscribers to control voice connections using DTMF after dialing into the system.

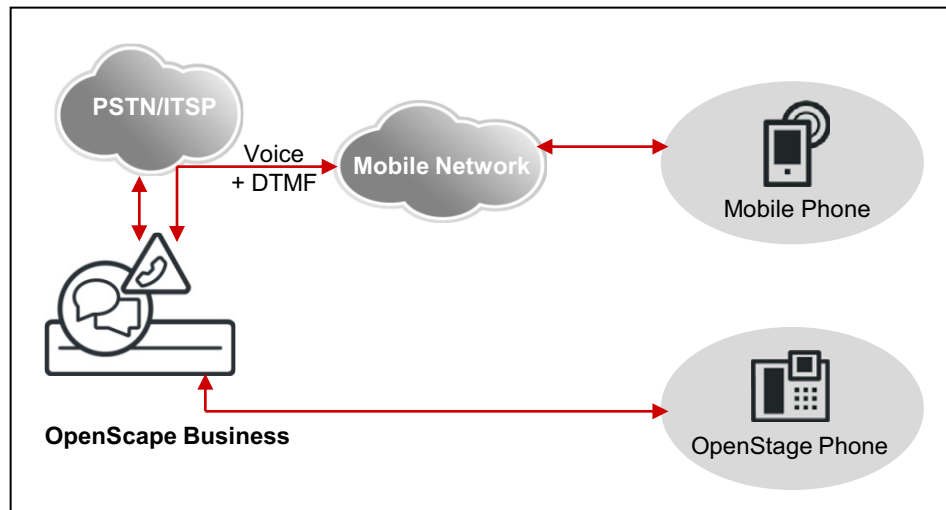

### Dialing Methods for Mobility Entry

Mobile phone users can choose between different dialing methods for outbound calls.

Mobility Entry offers the following dialing methods:

- Callback
- Call Through



If a mobile phone subscriber at the communication system calls a special DID number with a callback, the call is automatically terminated before the connection is established, and a callback is executed immediately. After the callback, no further authorization is necessary. The mobile phone subscriber can conduct internal and external calls and also use all Mobility features via the communications system.

The prerequisites for a callback are as follows:

- The external number of the calling telephone must be registered and configured at the communication system. If not, the call is disconnected, and no callback is executed.
- The DISA direct inward dialing number has been configured.
- The external number of the mobile phone subscriber is transmitted to the communication system (CLIP information).

#### **Features in a Dormant State**

- Dial a number
- Program or delete call forwarding
- Activate or deactivate Do Not Disturb
- Send message
- Reset all services
- Activate or deactivate station number suppression (CLIR)

#### **Features in the Call State**

- Consultation
- Alternate (Toggle/Connect)
- Conferencing
- Disconnect and return to held call
- Activate callback
- Enabling DTMF suffix dialing

The signaling of features is handled via system codes (e.g., \*1 to program call forwarding).

---

**INFO:** For Mobility Entry users, the station flag **Disa Class of service** must be enabled.

A maximum of 16 DTMF code receiver resources are available with OpenScape Business X, i.e., a maximum of 16 subscribers (analog, Mobility, etc.) can simultaneously reserve DTMF code receivers. Subscribers for whom the **DTMF-based feature activation** flag is set reserve one code receiver each for the duration of the call.

With OpenScape Business S, the control of features using DTMF codes is supported if the DTMF digits are transmitted as per RFC 2833. If an external Session Border Controller (SBC) is used in the network, no DTMF detection is possible.

---

---

**INFO:** Mobility entry must be only configured at nodes with direct CO access.

---

**Related Topics**

- [One Number Service \(ONS\)](#)
- [Comparison between Mobile Clients and Mobility Entry](#)
- [Dependencies for Mobile Clients and Mobility Entry](#)

## 18.2.3 Comparison between Mobile Clients and Mobility Entry

The mobile clients myPortal Mobile, myPortal to go and Mobility Entry support different features.

Feature	myPortal to go	Mobility Entry
<b>General functions</b>		
Mobile phone contract with data option	Yes (flat rate recommended)	no
Parallel call signaling on system telephone and mobile phone (twinning)	yes	yes
Transfer of caller number to the mobile phone (if the network transmits external phone numbers as CLIP; CLIP no screening)	yes	yes
One Number Service (if the network transmits external numbers as CLIP, CLIP no Screening))	yes	yes
Do not Disturb / Disablable call forwarding	no	yes
Station number suppression, enableable/disablable	no	yes
Automatic identification of registered stations	yes	yes
Operation without the Office phone (as a virtual station)	yes	yes
Can be used with OpenScape Business S	yes	yes
<b>Presence status, Journal, voicemail box</b>		
Change own presence status	yes	no
View presence status of other subscribers	yes	no
Journal	New, All, Missed, Answered, Inbound, Voicemail	no
Shared voicemail box; can also be checked on the go	yes	yes
Display received voicemail	Display new, retrieved and saved voicemails	no
<b>Dial</b>		
Access to contacts in mobile phone	yes	yes

Feature	myPortal to go	Mobility Entry
Access to contacts in the communication system	External directory (UC Suite), internal directory, personal contacts and system directory	no
Favorites	yes	no
Manual dialing	yes	yes
Redialing	yes	no
Dialing method	Callback, Call Through, Associated Dialing	Callback, Call Through
<b>During the call</b>		
Consultation	yes (not with SIP phone)	yes
Alternate (Toggle/Connect)	yes (not with SIP phone)	yes
Attendant	yes (not with SIP phone)	yes
Conferencing	yes (not with SIP phone)	yes
Callback on free and busy	no	yes
Call pickup from mobile phone to system telephone	yes	yes
Busy indicator also for calls at the mobile phone (with One Number Service)	yes	yes

---

**Related Topics**

- [Mobility Entry](#)

## 18.2.4 Dependencies for Mobile Clients and Mobility Entry

myPortal to go and Mobility Entry have dependencies on other features (e.g., DISA).

Dependency	myPortal to go	Mobility Entry
Mobility Callback DID	For the Mobile Callback dialing mode, the Mobility Callback DID must be configured.	
External destination phone number	Dialing external destination phone numbers by the mobile subscriber is controlled by the system because of the LCR configuration. Dialing can therefore be performed via the ISDN fixed network, analog fixed network or via ITSP.	
Activate CLIP No Screening	You cannot display a caller's number on the mobile station unless it was supplied unverified by the network provider.	
Mobile subscriber CLIP	The CLIP of the mobile subscriber must be transmitted to the communication system. This must be made available by the network provider.	
LCR Administration	As some network providers (fixed-network or ITSP) do not accept destination numbers with a separate international prefix, the system must delete this prefix from these destination numbers. This can be performed in least cost routing (LCR).	

Dependency	myPortal to go	Mobility Entry
B channels / External connections	The number of B channels depends on the connection duration or the number of mobile stations. Every incoming external call to a mobile subscriber requires two voice channels in the system. If there are not enough voice channels available, it may not be possible to reach a mobile subscriber, and the mobile subscriber may not be able to initiate any calls with the One Number Service.	
Emergency Numbers	When a mobile user dials an emergency number via the communication system, the location of his or her mobile phone cannot be identified. It is therefore advisable to dial an emergency number directly.	
Dialing internal station numbers	When dialing internal phone numbers in international format (e.g., 0004989100) at the mobile station, the location number of the communication system must be configured. Otherwise, internal destinations are routed via the exchange, which can result in costs.	
Directory maintenance	To ensure that the called party can be reached when dialing from directories in all dialing modes, all external phone numbers should be entered in canonical format (e.g., +49 89 100).	-
Firewall	A data channel is set up to the integrated web server of the communication system. Consequently, port forwarding to port 8801 (http) and port 8802 (https) must be configured in the firewall. However, it is recommended not to configure any port forwarding for port 8803 (https) in order to access UC Smart Assistant.	-
Data connection	It is advisable to sign a mobile phone contract with a flat-rate data plan. Users of volume rates should disable the "Auto Refresh" option in the settings of myPortal to go.	-
Parallel connections	For some features, a simultaneous voice and data connection is required. This must be supported by both the mobile network providers and the mobile devices.	-
Connection setup from the communication system to mobile stations via	All feature types	All line types that support DTMF transmission.

---

**Related Topics**

- [Mobility Entry](#)

## 18.2.5 One Number Service (ONS)

The One Number Service (ONS) effectively makes mobile phones operate as fixed network extensions. This means that subscribers can be reached under one

phone number world-wide and can identify themselves only by their respective fixed network numbers.

Setting up a team configuration enables the One Number Service with a single phone number for the workplace (system telephone) and the mobile phone. The caller dials the system phone's number (fixed network). Outgoing calls from mobile phones are signaled to the called party with the fixed network number. Another advantage of the One Number Service is the busy indicator for the mobile subscriber.

---

#### **Related Topics**

- [Mobility Entry](#)

## **18.2.6 Dual-Mode Telephony**

Dual-mode mobile phones support both GSM/UMTS networks and WLAN networks. Registration at the communication system is possible over a WLAN either as SIP station or as system client (i.e. HFA station).

If the dual-mode mobile phone is in the WLAN range, it is automatically called as system client (HFA station) or SIP station. If it is outside the WLAN range, the dual-mode mobile phone is called via GSM/UMTS (i.e., mobile phone integration functionality is available).

---

**INFO:** Dual mode for HFA is supported only when using myPortal to Go client and not with other devices or clients.

---

Automatic forwarding to the GSM phone number only works if the associated HFA or SIP station is entered in the system as a mobile phone station (mobile phone integration). This means that if the HFA or SIP station is registered, it is called as HFA or SIP station, and if it is not registered, it is called via the GSM phone number assigned in the mobile phone integration configuration. CTI call features are not available for SIP clients in myPortal to go. Call control usually occurs within the HFA or SIP clients instead (see also the Release Notice and <http://wiki.unify.com>).

Calls on the company premises occur over the WLAN. As long as calls are made over the WLAN, no call charges are incurred on the mobile phone. Handover and roaming are supported within the WLAN range (if the wireless LAN infrastructure is designed for it), but not from WLAN to GSM, and vice versa.

## **18.2.7 Configuring myPortal to go and Mobility Entry**

myPortal to go (Web Edition) and Mobility Entry are configured with the **Mobile Phone Integration** wizard.

Using the **Mobile Phone Integration** wizard, the administrator can:

- Set up the One Number Service
- Set up myPortal to go (Web Edition)
- Set up Mobility Entry
- Set up dual-mode phones

The mobile phone integration of GSM phones occurs via virtual stations. Features are transferred to the mobile station in this way. Every station with a corresponding license (mobility user) can be assigned a maximum of one mobile station

### **Operating Modes of Mobile Phones**

The following operating modes are implemented for mobile phones:

- **GSM Mode**  
Calls to the internal mobile call number are signaled at the GSM mobile phone.
- **WLAN Mode**  
If the WLAN mobile phone is reachable via the WLAN, the call is conducted via the WLAN. If the WLAN is not available, the call is made via GSM.

### **Twinning**

Calls are signaled in parallel at the mobile phone and the system telephone (twinning). To implement twinning, a team configuration must be set up once the configuration of the **Mobile Phone Integration** has been completed. To do this, use the **Team Configuration** wizard and first select the phone number under which the parallel signaling is to occur (e.g., the system telephone). For the use of myPortal to go (Web Edition), the last step is to reconfigure the user name to the team group in the **Mobile Phone Integration** wizard. On the system telephone, a Direct Station Select (DSS) key to the Mobility stations can be programmed for the seamless (i.e., uninterrupted) transfer of mobile phone calls. Full functionality is achieved with system telephones (HFA). SIP phones can be used but are subject to certain restrictions, e.g., they do not support MULAP keys.

---

### **Related Topics**

- [Configuring Team Configurations / Team Groups and Executive/Secretary Functions / Top Groups using Wizards](#)

## **18.2.7.1 How to Integrate GSM Mobile Phones**

Mobile phones can be integrated in the communication system with the **Mobile Phone Integration** wizard.

### ***Prerequisites***

- You are logged on to the WBM with the **Advanced** profile.

## Step by Step

- 1) In the navigation bar, click on **Setup**.
- 2) In the navigation tree, click on **Wizards > User Telephony**.
- 3) Click **Edit** to start the **Mobile Phone Integration** wizard. The **Select Station for Mobility** window appears.
- 4) Under **DISA access**, select (or enter) the **DID** number with which mobile stations can dial into the communication system.

Setup - Wizards - User Telephony - Mobile Phone Integration

Select station for Mobility

DISA port

Direct inward dialing: 234

Add Mobility User

Add New Mobility User

Mobility User callno	Mobility User DID	Name	Trunk access code + Mobile Call number	User name for myPortal for Mobile	State

**INFO:** DISA is required for Mobility Entry (to control the system using DTMF) and for myPortal for Mobile (only when using Call Through).

- 5) Click on **Add** or **Edit** for the appropriate subscriber whose GSM mobile phone is to be integrated into the communication system. The **Assign Mobility Stations** window appears.
- 6) Select **GSM Mode** as the mode for your mobile phone operation.
- 7) Under **Trunk access code+Mobile phone number**, enter the phone number of the mobile phone (e.g., 0016012345678).
- 8) Under **Internal call number of the Mobility station**, enter the corresponding internal number (e.g., 777) an **internal name** and the **DID number** of your choice. Note that the internal call number must not have been already assigned.
- 9) In the **Username for myPortal to go (Web Edition)** drop-down list, select **Automatic**; this will cause the internal number of the user to be used as the user name.

Setup - Wizards - User Telephony - Mobile Phone Integration

Change Mobility User allocation

Mobile phone mode in-house

GSM Mode

WLAN Mode

Mobility User

Trunk access code+Mobile Call number: 0016012345678

Internal call number of Mobility User: 777

DID of Mobility User:

Internal name:

User name for myPortal for Mobile: Automatic

- 10) Only with UC Smart: Assign a mailbox to the station if needed:
  - a) Select whether the station is to receive a default mailbox or an attendant mailbox (AutoAttendant) in the **UC Smart Mailbox type** drop-down list.
  - b) Only with default mailbox: If a caller may leave a message in the voicemail box, select the **Recording** check box.
  - c) Select a greeting from the **Greeting** drop-down list.
  - d) If the password of the voicemail box is to be reset, select the **Password Reset** check box.

---

**INFO:** The **Password Reset** check box must be cleared when setting up a new voicemail box. It is used to reset the password of the voicemail box. When a new voicemail box is created, the subscriber must change the initial password anyway when accessing his or her voicemail box for the first time.

---

- 11) Click **OK & Next**.
- 12) Click **OK & Next** followed by **Finish**.

### 18.2.7.2 How to Integrate Dual-Mode Telephones (GSM/WLAN) with HFA or SIP Client

The **Mobile Phone Integration** wizard can be used to configure a mobile phone as a dual-mode phone with system client (HFA client) or SIP client (WLAN mode).

#### *Prerequisites*

- You are logged on to the WBM with the **Advanced** profile.
- The HFA device or SIP station must be configured via the WBM.
- Mobility user license has been assigned to the subscriber.

#### *Step by Step*

- 1) In the navigation bar, click on **Setup**.
- 2) In the navigation tree, click **Wizards > User Telephony**.
- 3) Click **Edit** to start the **Mobile Phone Integration** wizard. The **Select Station for Mobility** window appears.
- 4) Under **DISA access**, select (or enter) the **DID** number with which mobile stations can dial into the communication system.



**INFO:** DISA is required for Mobility Entry (to control the system using DTMF) and for myPortal for Mobile (only when using Call Through).

- 5) Click on **Add** or **Edit** for the appropriate subscriber whose GSM mobile phone is to be integrated into the communication system. The **Assign Mobility Stations** window appears.
- 6) Select **WLAN Mode** as the mode for your mobile phone operation.
- 7) Under **Trunk access code+Mobile phone number**, enter the phone number of the mobile phone (e.g., 0016012345678).
- 8) Select **Assigned System- or SIP Client** from the drop-down list.

If the assigned system (HFA client) or SIP client is not yet configured, click on **Configure Client** and set up a system or SIP client. After the system or the SIP station configuration, you will be automatically returned to this page.

- 9) In the **Username for myPortal to go (Web Edition)** drop-down list, select the corresponding SIP or HFA device. **If you select Automatic**, the internal number of the user will be used as the user name.
- 10) Click **OK & Next**.
- 11) Click **OK & Next** followed by **Finish**.

### 18.2.7.3 How to Enable the Web Interface for Mobile Phones and Web Clients

#### Prerequisites

- You are logged into the WBM with the **Expert** profile.

Web services must be enabled as a prerequisite for the following features:

- Mobile Phone Integration
- Application Launcher

#### Step by Step

- 1) In the navigation bar, click on **Expert Mode**.
- 2) If you are using UC Smart, click in the navigation tree on **Applications > UC Smart > Basic Settings**.
- 3) Make sure that UC Smart is **Active**.
- 4) If you want to enable web services for mobile phones, select at least one of the following options:
  - If you want to enable encrypted connections, select the check box **HTTPS**.
  - If you want to enable unencrypted connections, select the check box **HTTP**.



---

**INFO:** For security reasons, it is strongly recommended that only an encrypted connection (HTTPS) be used when working with myPortal to go (Web Edition) over the Internet.

---

- 5) Click on **Apply** followed by **OK**.

### 18.2.7.4 How to Delete Mobile Phone Integration

Use the **Mobile Phone Integration** wizard to delete the integration of the mobile phone.

### **Prerequisites**

- You are logged on to the WBM with the **Advanced** profile.

### **Step by Step**

- 1) In the navigation bar, click on **Setup**.
- 2) In the navigation tree, click **Wizards > User Telephony**.
- 3) Click on **Edit** to start the **Mobile Phone Integration** wizard. The **Select Station for Mobility** window appears.
- 4) Click on **Edit** for the appropriate subscriber you want to delete. The **Assign Mobility Stations** window appears.
- 5) Click in the window below on **Delete Data**.
- 6) Click on **OK & Next**.
- 7) Click on **OK & Next** followed by **Finish**.

## **18.3 Mobility in the office**

Mobility in the office is achieved via Desk Sharing, Cordless Phones and WLAN phones. For Desk Sharing, IP Mobility (Mobile Logon and Flex Call) offers features for mobile users who want to use the phone at a different workplace just like their own phone.

### **18.3.1 Desk Sharing**

With Desk Sharing, multiple subscribers can share one system telephone and thus one IP phone (HFA).

With Desk Sharing, subscribers have no fixed workplace and no fixed office telephone. Desk Sharing enables multiple mobile subscribers of the communication system to share an office workplace and/or the phone. The subscriber simply logs in at the workplace phone where he or she happens to be currently working.

After the login, the station number of the logged in subscriber is transferred to the used system telephone. The used system telephone can no longer be reached under its original station number. If the subscriber logs in at another system telephone, his or her station number is transferred to that new system telephone. When the user logs out (Logout), the system phone automatically logs back on with its own non-mobile number.

One of the following steps must be performed at the system phone to activate the feature:

- Enter code for "mobile logon" + number of mobile station + optional password/PIN

When using phones with different numbers of function keys, the transfer of key layouts may be subject to restrictions.

If Desk Sharing is to be implemented for IP telephones (HFA) in networked nodes, an external DLS (Deployment Service) must be installed. The required expertise for this purpose is assumed.

The following features can be used for Desk Sharing:

- Speaker call (paging)
- Conferencing
- Override
- Toggle/Connect
- Parking
- Consultation
- Transfer
- Call pickup
- Do not disturb
- Call forwarding
- Send message (message waiting)
- Callback
- Station number suppression
- Ringing group on

---

**INFO:** For each mobile phone number, an additional Deskshare license is required. This Deskshare license must be activated for the subscriber, and the subscriber must be configured as **mobile**. In addition, the Relocate feature must be enabled.

A system telephone that is used for Desk Sharing does not necessarily require a license. However, if no license is activated and no Desk Sharing subscriber is logged in, not even emergency calls will be possible from this phone. The system telephone/subscriber must be configured as **Non-mobile**.

If a system telephone is not to be used for Desk Sharing, it must be configured as **Non-mobile and blocked**.

---

## 18.3.2 Integrated Cordless Solution

OpenScape Business Cordless is the integrated cordless solution for operating cordless telephones (DECT phones) via the communication system. The HFA features of OpenScape Business can then be used with the connected DECT phones.

In the integrated cordless solution, the DECT phones are internal, system-specific stations as opposed to separate DECT systems, which are connected via standard interfaces.

The connection of OpenScape Business base stations for the operation of DECT phones can be implemented via:

- For OpenScape Business X1/X3/X5: direct connections to the U<sub>P0/E</sub> interfaces of the mainboard of the communication system (DECT Light)
- For OpenScape Business X3/X5: connection to the U<sub>P0/E</sub> interfaces of an SLU8N/SLU8NR board (DECT Light)
- For OpenScape Business X5W: connection to the U<sub>P0/E</sub> interfaces of the SLC16N board

---

**INFO:** Slot 10 (slot level 5) is no longer supported in X5W system with part Number S30777-U777-X711.  
SLC16N card has been phased out.

---

- For OpenScape Business X8: connection to the U<sub>P0/E</sub> interfaces of an SLMUC (SLMU + CMAe) or SLCN board

The Cordless radio technology corresponds to the DECT (Digital Enhanced Cordless Telecommunications) Standard. The entire radio area administered by the system is made up of base stations, which together form either a complete network of overlapping radio cells or individual radio "islands". The size of a radio cell is dependent on the local/structural factors.

### **ECO Mode**

In ECO mode (economic mode), the transmit power of DECT phones is either reduced by a fixed value (static) or every DECT phone adjusts its transmit power independently to the received signal strength (adaptive). ECO mode can be enabled at the communication system on a system-wide basis for all DECT phones (**Expert Mode > Telephony > Cordless > System-wide**). No configuration is required at the DECT telephones. A manual system restart is needed to activate the feature in case of OpenScape Business X1, X3, X5

- Static adjustment of transmit power  
The DECT phones and base station reduce the transmit power to a set fixed value.
- Adaptive adjustment of transmit power  
The DECT phones transmit with normal or reduced transmit power, depending on the reception field strength. During a handover, the system first switches to the high transmit power and then reduces the transmit power, depending on the reception.

### **DECT phones**

The integrated Cordless solution supports GAP-enabled mobile telephones from third-party manufacturers. The full scope of HFA services can, however, only be used with approved DECT phones.

### **Configuration**

For a description of the configuration, see [Configuring the Integrated Cordless Solution](#).

## **Boards and Base Stations**

The descriptions of the boards and base stations can be found in the *Boards* chapter.

### **18.3.2.1 Cordless Direct Connections (DECT Light)**

In the case of a direct connection (also referred to as DECT Light), the base station is connected directly to a  $U_{P0/E}$  interface of the mainboard of the communication system or a  $U_{P0/E}$  interface of an SLU8 board (only for OpenScape Business X3/X5).

When connecting base stations to an SLU8 board (only for OpenScape Business X3/X5), the following connectivity requirements apply:

- In total, a maximum of 15 base stations (7 at the mainboard and 8 more at an SLU8 board) can be operated. The maximum number of connectable DECT telephones remains unchanged at 32.
- Only one SLU8 board can be used for the connection of base stations.
- The  $U_{P0/E}$  interfaces of the SLU8 board can be used with a mixed combination of base stations and/or telephones.
- Up to 4 simultaneous calls per base station can be conducted with an additionally installed CMA or CMAe module.

TDM User Licenses are required for the DECT phones.

### **18.3.2.2 Connecting Cordless Boards**

When using Cordless boards, the base stations are connected to the  $U_{P0/E}$  interfaces of the Cordless boards (SLC modules).

Base stations can be connected to the  $U_{P0/E}$  interfaces of the following cordless boards:

- SLC16N with OpenScape Business X5W (wall-mount system only)
- SLCN with OpenScape Business X8

You can install up to four Cordless boards (SLCN) in OpenScape Business X8. All four Cordless boards provide full cordless functionality (roaming and seamless connection handover) because the radio fields on the Cordless boards are synchronized within the communication system via SLC networking lines (Multi-SLC). Network-wide handover is currently not supported.

If there are not SLCN or SLC16N boards and BS is plugged on  $U_{P0/E}$ , then in case of an OpenScape Business network with CMI roaming over the nodes, a CMA or CMAe module is needed on the control board.

### 18.3.2.3 System Configuration

Depending on the communication system, up to 64 base stations can be connected, and up to 250 DECT phones can be used.

The following table shows the maximum possible system configuration for the integrated cordless solution and indicates in which cases analog trunk access of the communication system is possible.

---

**NOTICE:** The base stations BS4 (S30807-U5491-X), BS3/1 (S30807-H5482-X), BS3/3 (S30807-H5485-X) and BS3/S (X30807-X5482-X100) are being phased out and can no longer be ordered. However, they can still be connected to OpenScape Business X communication systems.

In the event of a failure, the current base stations should be used.

---



---

**INFO:** If no CMA/CMAe is installed, a maximum of two calls can be conducted per base station. In this case, ADPCM conversion is performed directly by the DECT base station, but echo cancellation is not directly supported. In case that echo cancellation is required a CMA/CMAe subboard is needed.

---



---

**INFO:** In the following table, the combination of SLMU card plus CMAe module is referred as SLMUC.

---

OpenScape Business	Maximum number of boards				Clock Module	Max. number of BaseStation BS when connected via 1xUP <sub>0</sub>	Ports/ Simultaneous calls per BS	Max. number of registered devices	Max. number of simultaneous calls
	SLC16N	SLCN	SLUN	SLMUC					
X1	–	–	–	–	–	7	1/2	16	14
	–	–	–	–	CMA	7	1/4	16	16
	–	–	–	–	CMAe	7	1/4	16	16
X3 Onboard UP <sub>0</sub> /E (SLUC)	–	–	–	–	–	7	1/2	32	16
	–	–	–	–	CMA	7	1/4	32	16
	–	–	1	–	CMA	15	1/4	32	16
	–	–	–	–	CMAe	7	1/4	64	28
	–	–	1	–	CMAe	15	1/4	64	48

**Mobility**  
Mobility in the office

OpenScape Business	Maximum number of boards				Clock Module	Max. number of BaseStation BS when connected via 1xU <sub>P0</sub>	Ports/ Simultaneous calls per BS	Max. number of registred devices	Max. number of simultaneous calls
	SLC16N	SLCN	SLUN	SLMUC					
X5	–	–	–	–	–	7	1/2	32	16
Onboard U <sub>P0/E</sub> (SLUC)	–	–	–	–	CMA	7	1/4	32	16
	–	–	1	–	CMA	15	1/4	32	16
	–	–	–	–	CMAe	7	1/4	64	28
	–	–	1	–	CMAe	15	1/4	64	48
	–	–	–	–	–	–	–	–	–
X5W	1	–	–	–	–	16	3/12	64	32*
X8	–	4	–	–	–	64	3/12	250 (128 per SLCN)	128**
	–	–	–	4	CMAe	64	3/12	250 (128 per SLCN)	192***

\* Max. value per SLCN16 is 32. In case of roaming the ADPCM conversion is always done on the SLC16N board where the handset is currently located. Therefore the number of simultaneous calls per system could be higher than 32, if the handset is located on the visiting SLC16N

\*\* The max. value per SLCN is 32. Depending on the location of the handsets in case of roaming, theoretically all devices that are registered (250) could be active if 4 SLCN cards are available.

\*\*\* SLCN and SLMUC can be merged within one system. The max. value is 32 per SLCN and 48 per SLMUC. Depending on the location of the handsets in case of roaming, theoretically all devices that are registered (250) could be active if 4 SLCN / SLMUC in sum are available.

### 18.3.2.4 Cordless/DECT Phones

Inserting the SLC board and entering the DECT system ID will automatically configure 16 handsets. The handset codes (PIN) are allocated and the handsets can be registered. Any additional handsets must be released before they can be used.

If a handset is replaced for servicing, the PIN must be changed before logging on the replacement handset. When a handset is replaced, a new PIN must be assigned to the relevant station in the communication system. This ensures that the handset is automatically logged off. It also improves security by preventing unauthorized parties from misusing the old PIN to log on the mobile handset.



### 18.3.3 Configuring the Integrated Cordless Solution

The configuration of the integrated Cordless solution includes setting up the base stations and the registration of DECT phones / mobile handsets at the communication system.

The configuration is performed in Expert mode.

The requisite steps for project planning, lighting, installation and cabling, setting up the system physically and inserting the SLC or CMA boards have been completed (see also Service Documentation). The DECT phones are charged. The DECT system ID is known. Information about subscribers, station numbers, names and, if necessary, their allocation to the SLC board is available.

#### General Process for Configuring the Integrated Cordless Solution

1. Configure the DECT system ID and other Cordless parameters, if necessary
2. Configure Cordless base stations
3. Log on the DECT phone at the Cordless base station
4. If necessary, add more DECT phones as required.

After the DECT phones have been commissioned, the phone numbers and names and other settings of the DECT subscribers can be edited via the WBM with the **Telephones/Subscribers** wizard.

#### DECT System ID

The DECT system ID is used to distinguish the different DECT systems and thus to identify the radio signals. Specifying the DECT system ID is necessary for synchronizing the registered handsets with the system.

The DECT system ID is an 8-digit hexadecimal string that is supplied on purchasing the DECT system. It is valid throughout the system (even for maintenance and service).

The DECT system ID consists of:

Digit	Meaning
1st. digit	E/ARC (Access Right Code)
2nd. - 5th. digits	EIC (Equipment Installers Code)
6th. - 7th. digits	FPN (Fixed Part Number)
8th. digit	FPS (Fixed Part Subscriber)

### 18.3.3.1 How to Configure the DECT System ID and Other Cordless Parameters (System-wide Data)

#### *Prerequisites*

- You are logged into the WBM with the **Expert** profile.
- An OpenScope Business base station is connected to the communication system.
- The 8-digit DECT system identifier supplied with the ordered DECT system is available.

#### *Step by Step*

- 1) In the navigation bar, click on **Expert Mode**.
- 2) Click on **Telephony > Cordless** in the navigation tree.
- 3) In the menu tree, click on **Cordless > System-wide**.
- 4) Enter the 8-digit DECT system identifier under **System ID**.
- 5) The system-wide settings under Echo Handling and Economic Mode should only be only if required. An explanation of the settings can be found under [Cordless > System-wide](#).
- 6) Click on **Apply**, followed by **OK**.

### 18.3.3.2 How to Configure Cordless Base Stations

#### *Prerequisites*

- You are logged into the WBM with the **Expert** profile.
- An OpenScope Business base station is connected to the communication system.

#### *Step by Step*

- 1) In the navigation bar, click on **Expert Mode**.
- 2) Click on **Telephony > Cordless** in the navigation tree.
- 3) In the menu tree, click on **Cordless > Base Stations**. All connected base stations are displayed.
- 4) If one or more base stations are connected directly (without SLC board) to the system (SLUC), you can enable or disable the base stations via the **Type** selection list:
  - a) **Base station**: The base station is activated, and 16 DECT phones and one SLC networking line are automatically preconfigured.
  - b) **No Port**: The base station is deactivated with all associated DECT phones and the SLC networking line.

- 5) If required, edit the preconfigured name of the base station (e.g., `Base 1`) under **Name**.
- 6) Specify the level for the base station (50% or 100%) under **Level**.
- 7) Click on **Apply** followed by **OK**.

### 18.3.3.3 How to configure DECT Phones for the First Time

#### *Prerequisites*

- You are logged into the WBM with the **Expert** profile.
- An OpenScape Business base station is connected to the communication system.

#### *Step by Step*

- 1) In the navigation bar, click on **Expert Mode**.
- 2) Click on **Telephony > Cordless** in the navigation tree.
- 3) In the menu tree, click on **Cordless > SLC**. All DECT phones already configured are displayed. When connecting a base station, 16 DECT phones are automatically preconfigured.
- 4) If required, edit the preconfigured internal call number of the DECT phone under **Call No**.
- 5) If required, edit the preconfigured direct inward dialing call number of the DECT phone under **DID**.
- 6) If required, edit the preconfigured name of the DECT phone under **Name**.
- 7) If required, edit the preconfigured mobile code (PIN) of the DECT phone under **Mobile code**. This code must be entered at the DECT phone when logging into the base station for the first time.
- 8) Click on **Apply** followed by **OK**.

---

#### **Related Topics**

- [How to Configure DECT Stations](#)

### 18.3.3.4 How to Register a DECT Phone (OpenStage/Gigaset Handset) at the Cordless System

Before logging a DECT phone on, you must use a system telephone and open the logon window with your code number and password. A maximum of 10 logon windows can be open at the same time. Then, enter the station numbers of the DECT phones that you wish to log on.

### **Step by Step**

- 1) Open the login window at the communication system:
  - a) Enter the code \*94 2 19970707 and the password at a system telephone.
  - b) Enter the station numbers of the DECT phones that you wish to log on.
- 2) Log on the DECT phone. Example: Logging the mobile telephone (station number 125) on to DECT telephone system 2 using the mobile telephone code (PIN) 11112345 (which has been configured as a mobile code via Manager E):
  - a) Switch on the mobile telephone by pressing the on-hook key for longer than one second. You will then hear a confirmation tone.
  - b) You must make the following entries within one minute. Press the menu key.
  - c) Select a station (in this case, Base 2) and confirm.
  - d) Open the advanced menu.
  - e) Select **Log on** and confirm your selection.
  - f) Enter the eight-digit PIN (mobile telephone code; in this case, **11112345**) and confirm your entry.
  - g) If logon is successful, the screen will alternately display **Base 2** (in this case) and the alarm icon.

### **18.3.3.5 How to Add Additional DECT Phones**

#### **Prerequisites**

- You are logged into the WBM with the **Expert** profile.
- An OpenScope Business base station is connected to the communication system.

#### **Step by Step**

- 1) In the navigation bar, click on **Expert Mode**.
- 2) Click on **Telephony > Cordless** in the navigation tree.
- 3) In the menu tree, click on **Cordless > SLC**.
- 4) Click on the desired board in the menu tree.
- 5) Click on the **Add DECT Stations** tab.
- 6) Enter the number of newly added DECT phones under **Number of DECT phones**. The newly added DECT phones are displayed under the **Edit DECT Stations**.
- 7) Click on **Apply**, followed by **OK**.

### 18.3.3.6 How to Delete DECT Telephones

#### *Prerequisites*

- You are logged into the WBM with the **Expert** profile.
- An OpenScape Business base station is connected to the communication system.
- DECT phones are configured.

#### *Step by Step*

- 1) In the navigation bar, click on **Expert Mode**.
- 2) Click on **Telephony > Cordless** in the navigation tree.
- 3) In the menu tree, click on **Cordless > SLC**. All DECT phones already configured are displayed.
- 4) Select the DECT phones to be deleted in the **Delete** column.
- 5) Click **Apply**, followed by **OK**.

### 18.3.3.7 How to Configure the Multi-SLC Parameters

#### *Prerequisites*

- You are logged into the WBM with the **Expert** profile.
- There are multiple SLCN boards inserted in the OpenScape Business X8.
- An OpenScape Business base station is connected to the communication system.

#### *Step by Step*

- 1) In the navigation bar, click on **Expert Mode**.
- 2) Click on **Telephony > Cordless** in the navigation tree.
- 3) In the menu tree, click on **Cordless > Multi-SLC**.
- 4) Edit parameters of the SLCN board:
  - a) If required, edit the preconfigured system-wide unique ID of the SLCN board under **SLC No.**  
Range of values: 1-15,17-31,33-47,....,127. Multiples of 16 are not allowed.
  - b) If required, edit the preconfigured system-wide unique call number of the SLC networking line of the SLCN board under **SLC number**.

---

**INFO:** For each SLC networking line, an internal S<sub>0</sub> station is set up. The SLC call number corresponds to the number of internal S<sub>0</sub> station.

---

- c) Make sure that the station flag **Call waiting rejection on** is disabled for the internal S<sub>0</sub> station.
- 5) If necessary, repeat step 4 for the other SLCN boards.
- 6) Click on **Apply** followed by **OK**.

### 18.3.3.8 How to Query the Data for Base Stations

#### *Prerequisites*

- You are logged into the WBM with the **Expert** profile.
- An OpenScope Business base station is connected to the communication system.

#### *Step by Step*

- 1) In the navigation bar, click on **Expert Mode**.
- 2) Click **Maintenance > Cordless** in the navigation tree.
- 3) In the menu tree, click on **Cordless > Base Stations**.
- 4) Click on the desired base station in the menu tree. The data of the base station is displayed. An explanation for the data can be found under [Cordless > Base Stations](#).
- 5) You can select up to 10 different frequency channels simultaneously for a base station. An explanation of the frequency channels can be found in the table under [Cordless > Base Stations](#).
- 6) Click on **Apply**, followed by **OK**.

### 18.3.3.9 How to Enable the Message Waiting Indication (MWI) for DECT Telephones

#### *Prerequisites*

- You are logged into the WBM with the **Expert** profile.

#### *Step by Step*

- 1) In the navigation bar, click on **Expert Mode**.
- 2) Click in the navigation tree on **Telephony Server > Basic Settings**.
- 3) In the menu tree, click **Basic Settings > System > System Flags**.
- 4) Select the **CMI MWI ringer** check box in the **System flags** area.

- 5) Click on **Apply**, followed by **OK**.

### 18.3.3.10 How to Check the Logon Status of DECT Phones

#### *Prerequisites*

- You are logged into the WBM with the **Expert** profile.
- An OpenScape Business base station is connected to the communication system.

#### *Step by Step*

- 1) In the navigation bar, click on **Expert Mode**.
- 2) Click on **Telephony > Cordless** in the navigation tree.
- 3) In the menu tree, click on **Cordless > SLC**. All DECT phones already configured are displayed.
- 4) For each DECT phone, the login status is displayed in the **Active** column as follows:
  - Green: The mobile phone is active.
  - Red: The board lockout switch was set for a logged-on mobile phone.
  - Yellow: The mobile phone was automatically logged off on changing the PIN.
  - Gray: No mobile phone has ever been logged on at this port.
- 5) Click on **Apply**, followed by **OK**.

## 18.3.4 Cordless IP

Cordless IP (IP DECT) is the optional Cordless solution that serves as an alternative to the integrated Cordless solution or is used with OpenScape Business S.

The DECT phones at Cordless IP communicate via the BSIP base station with the communication system like SIP phones. Consequently, only SIP features can be used with Cordless IP. For more information on Cordless IP, refer to the documentation for HiPath Cordless IP.

For all SIP subscribers who are logged on at a Cordless IP, the station parameter **autom. connection, CSTA** must be disabled. Otherwise, this could cause calls between SIP subscribers to not be set up via DECT IP.

## 18.3.5 WLAN Phones and Access Points

WLAN phones and dual-mode telephones enable mobile communications. These phones can be integrated in already existing WLAN infrastructures. With WLAN

Access Points, you can build wireless networks and use the same infrastructure for voice and data services. It is only recommended that only high-performance WLAN Access Points (e.g., from Enterasys) be used.

### 18.3.5.1 WLAN Requirements

When using a WLAN, it is important to ensure that the basic requirements for Voice-over-WLAN are satisfied. To implement the wireless portion of the network, a site survey may need to be conducted.

Decision-making aids:

- Smaller installations with up to three APs can be effectively assessed during a site visit or by studying the floor plans. It is not generally necessary to perform a site survey in this scenario.
- Site surveys should always be performed for installations with more than four APs. This applies specially to installations extending across multiple buildings or floors within buildings.
- A site survey is required irrespective of the number of APs in scenarios involving an RF-intensive environment or if you want the solution to operate alongside preexisting WLAN systems.

## 18.4 Mobility at Home

Mobility at Home is achieved through teleworking. This is done by integrating non-local phones (such as a home phone or mobile phone) in the OpenScape Business communication network.

The following types of teleworking stations are available:

- **VPN stations**  
OpenScape Business has a built-in VPN functionality. A total of 10 teleworkers can be simultaneously active via VPN. This may involve a home PC or a mobile phone with an Android or iOS operating system. The VPN connection is established between the native VPN client of the PC or of the mobile phone and the OpenVPN server of OpenScape Business. Users of UC Suite can specify their home phone number from home via their UC client and then use their private phone as an office phone (CallMe).
- **Device@Home: SIP@Home stations or System Device@Home stations**  
STUN-enabled SIP phones (e.g., Yealink T19) (SIP Device@Home stations) or HFA phones (System Device@Home stations) can register themselves at the communication system over the Internet by using the internal SBC function of OpenScape Business. To do this, the feature must be enabled in the station data for each SIP phone or HFA phones via the WBM. A STUN server must be additionally specified in the WBM only if no ITSP is being used or if the used ITSP does not offer any STUN server. SIP Device@Home does not support the transmission of video signals.



**Figure:** Device@Home (SIP Device@Home or System Device@Home) components

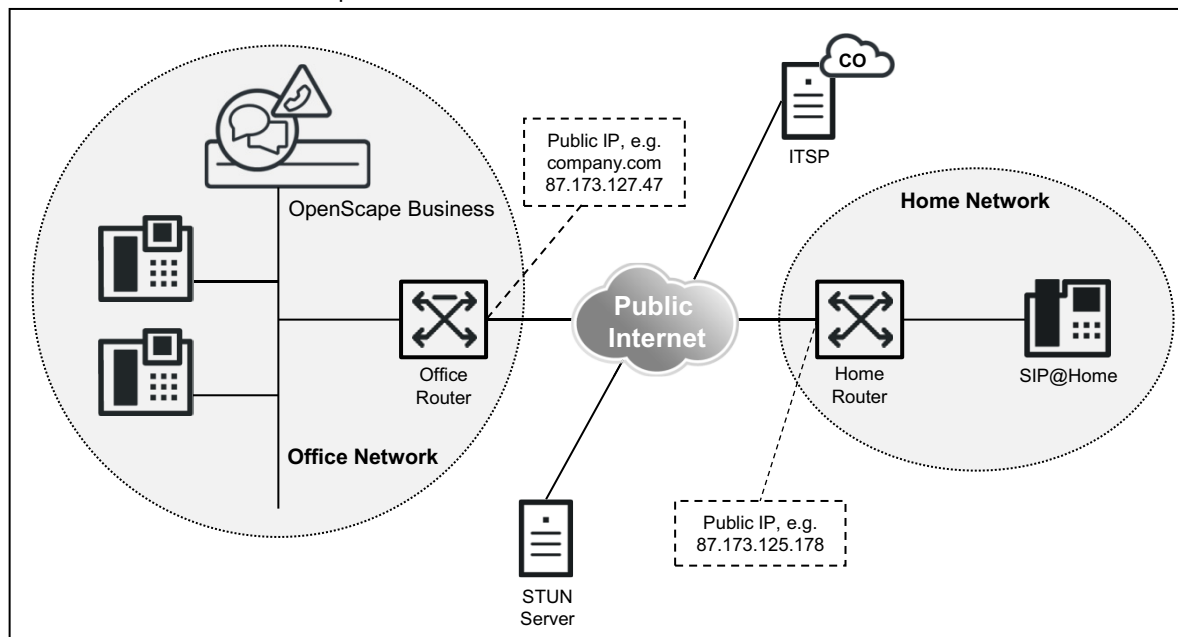

## 18.4.1 Configuring a VPN

In order to connect subscribers to the communication system via the integrated VPN functionality, certain configurations must be performed at both OpenScape Business and the VPN stations.

### Configuring OpenScape Business

For the VPN configuration of the communication system, see [How to Connect Teleworkers via a VPN](#).

### Configuring VPN Stations (VPN Clients)

To configure the VPN client, see [VPN Clients](#).

## 18.4.2 Configuration for SIP Device@Home

In order to set up connections from a STUN-enabled SIP phone to OpenScape Business over the Internet, certain configurations must be performed at OpenScape Business, the office Internet router and the SIP telephone.

### Configuring OpenScape Business

In order to enable a SIP station to register at the communication system over the Internet, the integrated SBC function must be activated for the SIP station (see [How to Enable Device@Home](#)).

The integrated SBC function detects the public IP address of the communication system and the port used with the aid of the STUN protocol. If the communication system is connected to an ITSP that offers a STUN server, no further configuration must be performed on the communication system. However, if either no ITSP is used or if the used ITSP does not offer any STUN server, then a STUN server must be configured in the system (see [How to Specify a STUN Server for Device@Home](#)).

### Configuring the Office Internet Router

In order to enable SIP phones to reach the communication system over the Internet, port forwarding for the external SIP port must be set up in the Office Internet router. To prevent SIP attacks from the Internet, a SIP port other than the default must be used as an external SIP port.

The transport protocol is set at the SIP phone.

**Table:** Configure Port Forwarding in the Office Router

Transport protocol	Internal SIP port	External SIP port	Comment
UDP	5070	Entering 5090, for example.	For port forwarding, the external and internal SIP ports must not be the same. A port with a different value than the internal default SIP port 5070 can thus be entered as an external SIP port.  UDP is therefore recommended.
TCP	5070 Switching to 5080, for example	Entering 5080 (= internal SIP port), for example	For port forwarding, the external and internal SIP ports must be the same. To use an external SIP port other than the default 5070, the internal SIP port must be changed. This requires a reconfiguration of all IP components that use SIP.  TCP is therefore <b>not</b> recommended.
TLS	5071	Entering 5071 (= internal SIP-TLS port)	For port forwarding, the external and internal SIP-TLS port must be the same. Since the internal SIP-TLS port already differs from the default SIP-TLS port, 5071 can also be entered as the external SIP-TLS port.  TLS is therefore recommended.

---

**INFO:** In an upgraded system no change regarding SIP ports is performed automatically. After upgrade the ports are:

SIP\_EXT = 5060

SIP\_TLS\_SUB\_EXT = 5062

These values must be changed manually by the administrator if Device@Home is used in a migrated system.

---

For TLS, valid certificates must be enabled in the communication system. TLS connections for SIP stations are supported at the LAN interface of the communication system, but not at the WAN interface. SRTP payload with SDES signaling is not supported.

If the Office Internet router is connected to the Internet without a fixed IP address, then DynDNS must be configured at the Office Internet router so that SIP stations can reach the communication system over the Internet. The current IP address is registered via the DynDNS account at regular intervals. With free DynDNS accounts, which expire at regular intervals, this may temporarily lead to disruptions.

### **Configuring SIP Phones**

As an example for the configuration you can find some tested SIP phones that support STUN, please refer to the Unify Experts wiki on the Internet. You will find the values that need to be entered at the SIP phone there.

### **Configuring the Home Internet Router**

No special configuration is needed on the home Internet router.

The home Internet router must meet the following requirements:

- The router must provide VoIP functionality with NAT enabled (not a symmetric NAT).
- The ALG function must be disabled in the router.

The Internet connection must provide enough bandwidth for the transmission of the call. For asymmetric DSL connections, in particular, the availability of sufficient upload bandwidth must be ensured.

## **18.4.3 Configuration for System Device@Home**

In order to set up connections from a System Device phone to OpenScape Business over the Internet, certain configurations must be performed at OpenScape Business, the office Internet router and the System Device phone.

**Figure:** Example of System Device@Home use case

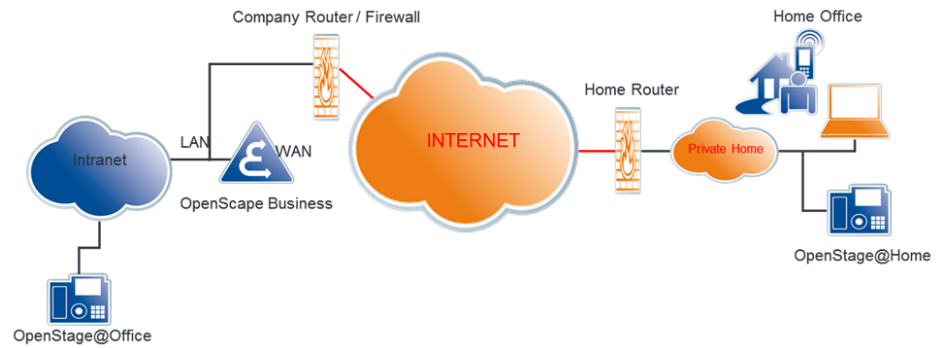

### Configuring OpenScape Business

In order to enable a System Device@Home station to register at the communication system over the Internet, the integrated SBC function must be activated for the System Device@Home station (see *How to Enable or Disable System Device@Home*).

The integrated SBC function detects the public IP address of the communication system and the port used with the aid of the STUN protocol. If the communication system is connected to an ITSP that offers a STUN server, no further configuration must be performed on the communication system. However, if either no ITSP is used or if the used ITSP does not offer any STUN server, then a STUN server must be made known to the communication system (see *How to Specify a STUN Server for System Device@Home*).

### Configuring the Office Internet Router

In order to enable System Device@Home stations to reach the communication system over the Internet, port forwarding for the System Device port must be set up in the Office Internet router. To be able to register from the Internet, the office router/ firewall must be configured with a port forwarding rule:

- external port TCP/4060 to internal port TCP/4062(HFA), for non-TLS
- external port TCP/4061 to internal port TCP/4063(HFA), for TLS

---

**NOTICE:** During migration from V2R1 to a higher version, the office internet router should also be reconfigured according to this rule.

---

- RTP port range in OpenScape Business X: 30274-30529 / RTP port range in OpenScape Business S: 30528-30887 (default values)
- TCP/8802 (HTTPS) (required for Unified Communications client (e.g. myPortal to Go, my Portal to Go Web, or VoIP for myPortal to Go configured as System Device@Home))

The transport protocol is set at the System Device@Home station.

If the Office Internet router is connected to the Internet without a fixed IP address, then DynDNS must be configured at the Office Internet router so that System Device@Home stations can reach the communication system over the Internet. The current IP address is registered via the DynDNS account at regular intervals.

With free DynDNS accounts, which expire at regular intervals, this may temporarily lead to disruptions.

### **Configuring the Home Internet Router**

No special configuration is needed on the home Internet router.

The home Internet router must meet the following requirements:

- The router must provide VoIP functionality with NAT enabled (not a symmetric NAT).
- The ALG function must be disabled in the router.

The Internet connection must provide enough bandwidth for the transmission of the call. For asymmetric DSL connections, in particular, the availability of sufficient upload bandwidth must be ensured.

### **Configuring the HFA Phone**

The Gateway must be configured with the DNS name (e.g. mycompany.net) so that the phone can reach the system over the Internet. An internal phone number must be added for the subscriber. The device's password must also be set.

### **Restrictions**

- It is not possible to configure XML applications at OpenStage
- Automatic phone software updates (triggered via DLI) are not supported. Only manual software update can be performed or by using an external DLS server. The phones must be updated to the latest firmware contained in the OpenScape Business software before configuring them for System Device@Home and installing them.

### **OpenScape Business RTPproxy limitations**

Call scenarios with payload routing via the OpenScape Business RTPproxy share common resources. As a result, the following limitations apply:

- A limited number of channels (i.e. parallel active calls), can be shared amongst all call scenarios:  
60 channels in OpenScape Business X  
180 channels in OpenScape Business S

---

**INFO:** The available channels are used in the following cases:

- System Device@Home
  - SIP Device@Home
  - ITSP connections
  - Circuit user connections
- 

- Internet connection bandwidth limitations

## 18.4.4 How to Enable Device@Home

### Prerequisites

- You are logged into the WBM with the **Expert** profile.

### Step by Step

- 1) In the navigation bar, click on **Expert Mode**.
- 2) In the navigation tree, click on **Telephony > Stations**.
- 3) In the menu tree, click **Stations > IP Clients > SIP Clients** or **System Clients**
- 4) Click on the desired SIP or HFA station in the menu tree.
- 5) Click the **Edit Workpoint Client Data** tab.
- 6) Make sure that the **Authentication active** check box is selected and that a password is entered. The values specified here must also be entered on the SIP phone or System Device.

---

**INFO:** A strong password should be used when connecting over the Internet (at least 8 characters including uppercase, numeric, and special characters).

---

---

**NOTICE:** The password of Deskshare clients which are declared as @Home should contain only numerical characters. This password is actually the pin code for the activation of the mobility feature (feature's service code: \*9419). Devices support only numerical characters for pin.

---

After setting the password, the **Internet Registration with internal SBC** is available to be enabled.

---

**INFO:** After speed upgrade or system restart, **Authentication active** checkbox will be activated for all SIP endpoints and will be greyed-out so the user cannot disable it, if at least one SIP station has the **Internet Registration with internal SBC** flag activated.

---

## 18.4.5 How to Specify a STUN Server for Device@Home

### Prerequisites

- You are logged into the WBM with the **Expert** profile.
- No ITSP is being used or the used ITSP does not provide any STUN server.

***Step by Step***

- 1) In the navigation bar, click on **Expert Mode**.
- 2) In the navigation tree, click on **Telephony > Voice Gateway**.
- 3) In the menu tree, click **Internet Telephony Service Provider**.
- 4) Click the **Edit STUN Configuration** tab.
- 5) Enter the IP address or the host name of the STUN server (e.g., `stun.serviceprovider.com`) under **IP Address / Host name** in the **Default STUN Server** area.
- 6) Enter the port of the STUN server (e.g., 3478) under **Port** in the **Default STUN server** area.
- 7) Click **Apply**, followed by **OK**.

# 19 Security

Security involves protecting the communication system and the stored and transmitted data against unauthorized access. This can be achieved through access protection for the IP network (firewall) and encrypted transmissions (SSL VPN, for example).

## Security Checklist

The aspect of secure communications has been taken into account in the default settings of the communication system. During the initial setup, the functions and settings may need to be adapted to the specific situation of the customer, and additional provisions may have to be made in the customer environment. In order to raise the awareness of security risks and to implement suitable measures to counteract them, a security checklist is provided in the product documentation. It is urgently recommended that this checklist be discussed with the customer during the initial setup and that all implemented measures be carefully documented.

## 19.1 Firewall

A firewall is a system of software and hardware components that restricts access to different networks in order to implement a security concept.

Firewalls are installed at the interfaces between individual networks and control the data flow between the sub-segments to prevent unwanted data traffic and only allow the desired traffic. Firewalls are most frequently used to control traffic between a local network (LAN) and the Internet.

In any corporate network, a firewall isolates the internal LAN from the Internet.

The communication system provides integrated security functions. Different functionality is offered by OpenScape Business X and OpenScape Business S for this purpose.

OpenScape Business X provides the following features:

- Port Firewall / NAT (firewall between WAN port and LAN)
- Application Firewall (firewall for access to the communication system)

OpenScape Business S uses the Linux firewall.

### 19.1.1 Port Handling

Port handling is used for activating ports (port mapping, port forwarding) in the firewall of the integrated router of the OpenScape Business X.



---

**NOTICE:** You should open ports only if it is absolutely necessary for a particular application!

---

Ports or services are required for communication via the protocols TCP and UDP because they allow multiple applications to exchange data simultaneously over a single connection.

The term firewall is generally understood as a port firewall (i.e., the blocking of individual services, or ports). The port firewall affects only the WAN port of OpenScape Business.

With OpenScape Business S, a port firewall can be enabled on the LAN port under Linux. With OpenScape Business X, the firewall on the WAN port is enabled in order to protect the internal network (LAN ports) against attacks from the Internet. If any specific ports/services need to be accessible from the Internet, they must be explicitly released (see [Opening Ports](#)). All ports/services for the functionality of OpenScape Business X are automatically released on the LAN port (into the internal network).

OpenScape Business S has only one LAN port (into the internal customer network) and is protected from the Internet by other components/routers in the customer network. In addition, the Server-internal Linux firewall is enabled. To provide the required OpenScape Business functionality, specific ports/services must be opened (to allow the phones to communicate with OpenScape Business S, for example). This is done automatically, but the administrator can disable individual services.

### Port Numbers

Port numbers can accept values between 0 and 65535 which is how they are assigned to the different applications. The ports between 0 and 1023 are referred to as 'well-known ports' and are permanently assigned by the IANA (Internet Assigned Numbers Authority). A list of these ports can be found under <http://www.iana.org/assignments/port-numbers>.

## 19.1.1.1 Opening Ports

If the system sets up the Internet access (via the WAN port), then, by default, the only communication allowed is from within the internal network (i.e., from the corporate network or the communication system itself) to the Internet and the associated response packets. Requests initiated from the Internet are blocked. This security setting can be bypassed by opening the port selectively to operate a Web server on the network, for example.

---

**NOTICE:** If the communication system is used as an Internet router, port 5060 must be closed (default setting). For Internet

telephony via an ITSP, the communication system opens the relevant ports and keeps them open.

Port 5060 must likewise be closed If an external router or firewall is being used. The communication system is responsible for opening this port (if required).

---

### 19.1.1.2 How to Configure the Opening of Ports

The **Firewall** wizard can be used to open ports so that the communication system or PC on the LAN are accessible via the WAN port. The opening of ports entails the risk of access by unauthorized persons. Consequently, only the ports that are urgently needed should be opened.

#### *Prerequisites*

- You are logged on to the WBM with the **Advanced** profile.

#### *Step by Step*

- 1) In the navigation bar, click on **Setup**.
- 2) In the navigation tree, click **Wizards > Security**.
- 3) Click on **Edit** to start the **Firewall** wizard. The **Opening ports** window appears.
- 4) Select the check box **NAT Rule Active** in the row associated with the relevant application or required service for which you want to release ports.
- 5) Enter the data for the release in the **Global Port**, **Local IP Address**, and **Local Port** fields.
- 6) To open a port for a service that is not entered, click **Add** and fill in the **Description**, **NAT Rule Active**, **Global Port**, **Local IP Address** and **Local Port** fields.
- 7) Click on **OK & Next**.
- 8) Click on **Finish**.

### 19.1.1.3 Port Management

Port Management can be used to change some of the ports used by the communication system itself. This enables the network communication to be customized for each customer network even if the ports are already being used elsewhere.

If changes are to be made at the port administration, these changes must generally be made in all components (phones, systems, etc.) simultaneously in order to retain functionality.

### 19.1.1.4 How to Edit Global Port Management Settings

You can specify port numbers for the individual functions here.

#### *Prerequisites*

- You are logged into the WBM with the **Expert** profile.

#### *Step by Step*

- 1) In the navigation bar, click on **Expert Mode**.
- 2) Click **Telephony > Basic Settings** in the navigation tree.
- 3) In the menu tree, click **Port Management**. The **Edit Global Port Management Settings** tab appears.
- 4) Enter the port for each respective function under **Port Number** or leave the default settings unchanged.
- 5) Click on **Apply** followed by **OK**.

## 19.1.2 NAT

NAT (network address translation) is a procedure for replacing one IP address in a data packet with another. The clients in an internal network use private IP addresses. As private IP addresses are not forwarded in a public network, you can use NAT to map the private IP addresses to a public IP address. This gives internal clients access to the public network while masking the structure of the internal network with its private IP addresses and keeping it separate from the public network (for example, the Internet). NAT and NAT rules are needed for the opening of ports.

Address translation is performed at the gateway between an internal and a public network. NAT can run on an Internet router, a server or another specialized device. An Internet router can use NAT, for instance, to connect the internal network to the Internet.

The internal network appears on the Internet with only a single public IP address, which is assigned to the Internet router by the Internet Service Provider (ISP). All access attempts made from the internal network are routed via this official IP address with different port numbers. The Internet router replaces the private IP addresses with the official IP address assigned by the ISP. In the case of incoming data packets, the official IP address is replaced by the private IP addresses. The relevant port numbers are important for allocation. Only specially enabled private IP addresses can be reached directly from the Internet.

#### **NAT rules**

You can use NAT rules to define if private (local) IP addresses should be reached directly from the Internet. Individual NAT rules can be defined for this or the default NAT rules already set can be used for the services FTP Server, HTTP Server, etc. A total of 20 NAT rules can be defined. In order to use a NAT rule, the

local address data of the client PC that will provide these services for the Internet must be entered, and the NAT rule must be activated. Multiple NAT rules can be configured together with the help of a NAT table editor. You can delete NAT rules that are no longer needed.

### Ports

At startup, servers usually require the operating system to provide specific ports in order to accept connections. Typical examples include an HTTP server on port 80, an FTP server port 21, etc. Clients normally request the operating system for a random port in order to set up connections.

## 19.1.2.1 How to Configure a NAT Rule

### *Prerequisites*

- You are logged into the WBM with the **Expert** profile.

### *Step by Step*

- 1) In the navigation bar, click on **Expert Mode**.
- 2) In the navigation tree, click **Telephony > Routing**.
- 3) Configure the NAT rule:
  - If you want to define a new NAT rule, click on **NAT** in the menu tree and then on the **Add NAT** tab.
  - If you want to edit an existing NAT rule, navigate in the **NAT** menu tree down to the desired NAT rule.
- 4) Enter a name for the NAT rule in the **Description** field. In the case of a standard NAT rule, this name cannot be changed.
- 5) Enter the IP address you want to enable for the client in the internal network in the **Local IP Address** field.
- 6) Enter the port number used by the internal client's application in the **Local Port** field.
- 7) Enter the port number used by the external communication partner's application in the **Global Port** field.
- 8) In the **Protocol** drop-down list, select the transport protocol (**TCP** or **UDP**) used by the application. The protocol cannot be changed in the case of a standard NAT rule.
- 9) Select the radio button **NAT Rule Active** if you want to apply the NAT rule.
- 10) Click on **Apply** followed by **OK**. The activated NAT rule is identified under the menu item **NAT** with a green symbol.

## 19.1.2.2 How to Configure NAT Rules with the NAT Table Editor

### *Prerequisites*

- You are logged into the WBM with the **Expert** profile.

### *Step by Step*

- 1) In the navigation bar, click on **Expert Mode**.
- 2) In the navigation bar, click on **Telephony > Routing**.
- 3) In the menu tree, click on **Routing**.
- 4) Click in the **NAT** menu tree and then on the **NAT Table Editor** tab.
- 5) Configure the NAT rule:
  - If you want to define a new NAT rule, fill in the fields of the first row as described below.
  - If you want to edit an existing NAT rule, click in the desired field of the NAT rule and fill them in as described below.
- 6) Enter the IP address you want to enable for the client in the internal network in the **Local IP Address** column.
- 7) Enter the port number used by the internal client's application in the **Local Port** column.
- 8) Enter the port number used by the external communication partner's application in the **Global Port** column.
- 9) In the **Protocol** drop-down list, select the transport protocol (**TCP** or **UDP**) used by the application. The protocol cannot be changed in the case of a standard NAT rule.
- 10) To apply the NAT rule, enable the **Active** column with a check mark.
- 11) Enter a name for the NAT rule in the **Description** column. In the case of a standard NAT rule, this name cannot be changed.
- 12) Saving the NAT rule:
  - If you have configured a new NAT rule, click **Add** and then **OK**. The new NAT rule is inserted at the end of the table.
  - If you have edited an existing NAT rule, go to step 5.
- 13) Click on **Apply**. An activated NAT rule is identified under the menu item **NAT** with a green symbol.

## 19.1.2.3 How to Delete a NAT Rule

### *Prerequisites*

- You are logged into the WBM with the **Expert** profile.

### Step by Step

- 1) In the navigation bar, click on **Telephony > Routing**.
- 2) In the navigation tree, click **Routing**.
- 3) Click on **NAT** in the menu tree.
- 4) Click on the NAT rule to be deleted in the menu tree and click the **Delete NAT** tab. You cannot delete predefined default NAT rules.
- 5) Confirm the warning with **Delete** and then click **OK**. The NAT rule is deleted from the list of NAT rules under the **NAT** menu item.

## 19.1.3 Application Firewall

The Application Firewall is used to restrict access to specific services such as FTP or LDAP. It is disabled by default and can be enabled by defining appropriate rules.

The following services can either be blocked or restricted to specific IP addresses or IP address ranges by the Application Firewall in OpenScope Business X:

Service	Ports
FTP	21, 40000 - 40040
ssh (locked by default)	22
LDAP	389
HTTPS	443
Postgres	5432
Manager E	7000
CSTA	7001 (FP), 7004 (FP), 8800 (CSP)
Observer	8808

Only the listed services can be blocked via a selection menu in Expert mode.

Telephone features such as SIP, HFA, etc. cannot be blocked using the Application Firewall.

A service can be selected multiple times; each time, different IP restrictions can be specified.

---

**NOTICE:** The activation/deactivation or modification of firewall parameters may severely restrict the functionality of the board (LAN-based administration may no longer be possible, for example).

---

### 19.1.3.1 How to Display the Configuration of the Application Firewall

#### *Prerequisites*

- You are logged into the WBM with the **Expert** profile.

#### *Step by Step*

- 1) In the navigation bar, click on **Expert Mode**.
- 2) In the navigation tree, click **Telephony > Security**.
- 3) Navigate in the menu tree to **Application Firewall**.
- 4) Click on the **Display Services** tab to view the blocked services.
- 5) The name of the rule is displayed in the **Rule Name** field.
- 6) The check mark under **Rule activated** shows you whether or not a rule is enabled.
- 7) In the field **Lower Limit of Source IP Address Range** you will see the lower limit of the blocked IP addresses.
- 8) In the field **Upper Limit of Source IP Address Range** you will see the upper limit of the blocked IP addresses.

### 19.1.3.2 How to Restrict Services using the Application Firewall

#### *Prerequisites*

- You are logged into the WBM with the **Expert** profile.

#### *Step by Step*

- 1) In the navigation bar, click on **Expert Mode**.
- 2) In the navigation tree, click **Telephony > Security**.
- 3) Navigate in the menu tree to **Application Firewall**.
- 4) Click on the **Add Service** tab to block a range of IP addresses and/or a service.
- 5) Assign a name for this service (this rule) under **Rule Name**.
- 6) Under **Address Range**, enter the **Lower Limit** and the **Upper Limit** for the allowed source IP addresses.

It is possible to block access completely by entering 127.0.0.1.

---

**INFO:** You should activate a rule only after you are convinced that the authorized IP addresses have been configured correctly!

---

- 7) Click on **Save**.

### 19.1.3.3 How to Delete the Configuration of the Application Firewall

#### *Prerequisites*

- You are logged into the WBM with the **Expert** profile.

#### *Step by Step*

- 1) In the navigation bar, click on **Expert Mode**.
- 2) In the navigation tree, click **Telephony > Security**.
- 3) Navigate in the menu tree to **Application Firewall**.
- 4) Click on the **Delete all Services** tab to delete all services.

### 19.1.4 Services Administration (OpenScape Business S)

The Linux-internal firewall is enabled by default, which prevents access to OpenScape Business S. The communication system does, however, also provide services (e.g., the telephony service) that require open ports (services). After the installation of OpenScape Business S, these required ports/services must therefore be opened in the firewall. If services such as SNMP are not to be used, they can be disabled in the Linux firewall.

---

**NOTICE:** Note that the blocking of services that are used by OpenScape Business S can lead to a degradation and/or failure in the functionality of the communication system.

---

#### 19.1.4.1 How to Add or Block Services

#### *Step by Step*

- 1) Click on **Computer** in the task bar.
- 2) In the menu tree, click on **System > YaST**.
- 3) Enter the password for the root user and click **Continue**.
- 4) Click on **Security and Users** in the menu tree.
- 5) In the **Security and Users** area, click on **Firewall**.
- 6) In the menu tree of the **Firewall Configuration: Start-up** window, click on **Allowed Services**.
- 7) In the field **Allowed Services for Selected Zone**, select the area for which you want to change services (**External Zone**, **Demilitarized Zone**, **Internal Zone**).



- 8) In the field **Service to allow**, select the specific services to be enabled (added) and click on **Add**. All currently permitted services are listed in the pull-down menu.
- 9) In the **Allowed Service** field, select the services to be disabled and click on **Delete**.
- 10) Enable the **Protect Firewall from Internal Zone** check box required.
- 11) Click on **Advanced** to add any ports or numeric protocols to the firewall (**TCP Ports, UDP Ports, RPC Ports** and **IP Protocols**). Click OK when finished.
- 12) Click on **Next** to display a window with your firewall settings. If required, you can view more information via **Show Details**.
- 13) Click on **Finish**.

## 19.2 Signaling and Payload Encryption (SPE)

SPE is a security feature for the transmission of signaling and payload data between IP system phones and the communication system. The feature is based on an asymmetrical encryption mechanism in which public and private keys are used.

Encryption of signaling and payload data:

- Signaling encryption: The signal transmission between the gateway and clients is encrypted with a 128-bit key. The TLS protocol with AES encryption is used for the transmission.
- Payload encryption: The payload or voice data is transmitted using the Secure Real-time Transport Protocol (SRTP). They are likewise encrypted with a 128-bit key (AES). SRTP is also used for IP networking. The procedure for exchanging the key for SRTP is known as Multimedia Internet Keying (MIKEY).

For SPE, the individual system telephones and communication systems involved must be able to uniquely identify one another. This is achieved through certificates, which also provide the public keys.

The keys and certificates are distributed by the DLS server; however, they can also be distributed manually.

---

**INFO:** WL2 and SIP phones cannot be used in conjunction with SPE.

---

An encrypted connection only exists for direct connections between two system telephones or for conferences.

### **SRTCP Encryption**

SRTCP (Secure Real-time Transport Control Protocol) is an extension of the SRTP protocol and implements the security of control data. The extension consists of three additional fields: an SRTCP index, an encryption flag and an authentication tag.

**SPE conformity**

Family Protocol / Interface	Signalling Encryption								Payload Encryption					
	Column 1	HFA Subscriber	SIP Subscriber	TDM Subscriber	Analog Subscriber	SIP-Q Trunking	ISDN CO	FAX (T38, G711)	Column 2	HFA Subscriber2	SIP Subscriber2	TDM Subscriber2	Analog Subscriber2	IP-Q Trunking (G100)
<b>OpenScope Office MX/LX</b>														
HFA		s	nv	t	t	s	t	t		y	n	y	y	y
SIP-UA		t*	t*	nv	nv	t*	nv	nv		n	n	n	n	n
SIP-Trunking/ITSP		t*	nv	nv	nv	t*	nv	nv		n	n	n	n	n
SIP-Q Homogenous		s	t*	t	t	s	t	t*		y	n	y	y	y
Media Server / Conference		t	nv	nv	nv	t	nv	nv		n	n	n	n	n
<b>Openscape Business X3/X5/X8</b>														
HFA		s	nv	t	t	s	t	t		y	n	y	y	y
SIP-UA		t*	t*	nv	nv	t*	nv	nv		n	n	n	n	n
SIP-Trunking/ITSP		t*	nv	nv	nv	t*	nv	nv		n	n	n	n	n
SIP-Q Homogenous		s	t*	t	t	s	t	t*		y	n	y	y	y
SIP-Q Heterogenous - H4k		s	t*	t	t	s	t	t*		y	n	y	y	y
SIP-Q Heterogenous - OSV		s	t*	t	t	s	t	t*		y	n	y	y	y
Media Server / Conference		t	nv	nv	nv	t	nv	nv		n	n	n	n	n
MEB / VSL		t	nv	nv	nv	t	nv	nv		n	n	n	n	n

**Legend:**

nv	No VoIP security
t	Default: TLS on the VoIP side; no end-to-end secure payload
s	Signaling and Payload Encryption (SPE)
*	No End-to-end Signaling Encryption (TLS)
*	
	Payload encryption
y	Secure Payload (SRTP)
n	Non-Secure Payload (RTP)

## 19.2.1 How to Enable or Disable SPE Support

### *Prerequisites*

- You are logged into the WBM with the **Expert** profile.

### *Step by Step*

- 1) In the navigation bar, click on **Expert Mode**.
- 2) Click **Telephony > Basic Settings** in the navigation tree.
- 3) In the menu tree, click on **System > System Flags**.
- 4) Select one of the following options:
  - If you want to enable Signaling and Payload Encryption, select the **SPE Support** check box.
  - If you want to disable Signaling and Payload Encryption, clear the **SPE Support** check box.
- 5) Click on **Apply** followed by **OK**.

## 19.2.2 How Change the SPE Security Settings

### *Prerequisites*

- You are logged into the WBM with the **Expert** profile.

### *Step by Step*

- 1) In the navigation bar, click on **Expert Mode**.
- 2) In the navigation tree, click on **Security > Signaling and Payload Encryption (SPE)**.
- 3) In the **Edit Security Configuration** tab, under **Minimal length of RSA keys**, select the minimum key length for the security protocol (512, 1024 or 2048).
- 4) Select the item **Check certificate with CRL monitoring** if you want to a comparison with the CRL (certificate revocation lists) lists.
- 5) Under **Maximum Re-Keying interval [hours]**, enter the time (in hours) after which the key pairs are reassigned.
- 6) Click on **Apply**.

## 19.2.3 How to Import an SPE Certificate and Private Key (PKCS#12)

If no custom certificate is available, a self-signed CA certificate can be generated via **SSL > Certificate Generation** to produce and save a CA-signed server certificate (PKCS #12) that can be saved. This is then imported for SPE.

**Prerequisites**

- You are logged into the WBM with the **Expert** profile.

**Step by Step**

- 1) In the navigation bar, click on **Expert Mode**.
- 2) In the navigation tree, click on **Security > Signaling and Payload Encryption (SPE)**.
- 3) Navigate in the menu tree to **SPE Certificate**.
- 4) Enter the password for decryption that was created when generating the file under **Import SPE certificate plus private key (PKCS#12 file)** in the **Passphrase for decryption** field.
- 5) Under **File with certificate and private Key (PEM or PKCS#12 format)**, enter the name of the certificate file or click on **Browse** to search for it.

---

**INFO:** After you install a certificate for the first time with SPE enabled, an automatic reset is performed!

---

- 6) Click on **View Fingerprint of Certificate** to check the integrity of the certificate.

## 19.2.4 How to Import an SPE CA Certificate

This step is not required when using certificates that were created under **SSL Certificate Generation** itself.

**Prerequisites**

- You are logged into the WBM with the **Expert** profile.

**Step by Step**

- 1) In the navigation bar, click on **Expert Mode**.
- 2) In the navigation tree, click on **Security > Signaling and Payload Encryption (SPE)**.
- 3) Navigate in the menu tree to **SPE CA Certificate(s)**.
- 4) In the **Import trusted CA certificate (X.509 File) for SPE** window, under **File with certificate (PEM or binary)**, enter the file name of the certificate file or click **Browse** to select a file.
- 5) Under **CRL Distribution Point (CDP) Protocol**, select the protocol for the CRL (certificate revocation lists) lists (**LDAP** or **HTTP**).
- 6) Under **CDP (without ldap://, for example)**, enter the desired server.
- 7) Click on **View Fingerprint of Certificate**.

## 19.2.5 How to Enable or Disable SPE for a Station

### *Prerequisites*

- You are logged into the WBM with the **Expert** profile.

### *Step by Step*

- 1) In the navigation bar, click on **Expert Mode**.
- 2) Navigate in the menu tree under **Stations > Station > IP Clients** down to the desired station (system client).
- 3) Navigate in the **Stations** window under the **Edit station parameters** tab to the **Payload Security** entry.
- 4) Select one of the following options:
  - If you want to activate the function, select the item **On** under **Payload Security**.
  - If you want to deactivate the function, select the item **Off** under **Payload Security**.
- 5) Click on **Apply**.

## 19.3 Virtual Private Network (VPN)

A virtual private network (VPN) is a PC network used to transport private data in a public network (such as the Internet). It therefore transfers data securely over an insecure network. Data is transmitted in encrypted format.

VPN offers you:

- Secure connection via an unprotected medium (Internet)
- Protection of confidential data against manipulation
- Reliable integration of external partners in the corporate network
- Access to corporate information for field service

### **Overview of a VPN**

To ensure secure communications, VPN works as follows: A tunnel is created between the communication peers. In this instance, tunnel configuration is subject to authentication and authorization. The actual data is encrypted following tunnel configuration.

A VPN can be set up between (at least) two computers or networks (tunnel endpoints).

Two types of networking exist:

- **Site-to-Site VPN**  
This type of networking performs encryption between two VPN gateways; data is transferred unencrypted within the LANs.

- End-to-Site VPN  
Remote access VPN (remote access by mobile teleworkers)

**System-Specific Information**

The VPN parameters are principally administered via the VPN wizard.

Note that the connection to the communication system must be a secure SSL connection using OpenSwan or OpenSSL.

**Dependencies**

Topic	Dependency
DynDNS	The VPN endpoints must be reachable via a domain name or a fixed IP address. If this is not the case, DynDNS can be used.
DynDNS	If you change an IP address in VPN, the communication system updates the host-name-specific data (IP address) in DynDNS.
DNS	Every VPN partner can resolve the host name/IP address via the standard DNS protocol. All DNS names (such as host name) must be fully qualified domain names (FQDN). Connections via IPsec tunnels are not possible while the IP address is being updated via DNS.

**19.3.1 Requirements for VPN**

To ensure the quality of the voice and data transmissions, the networks being used must satisfy certain requirements. Due to encryption, in particular, more bandwidth than for other networks must be planned.

In the following examples and in the tables, the encryption mode "ESP Tunnel Mode with Authentication" is used as a basis. This mode offers the highest security for site-to-site VPNs.

**Structure of an encrypted voice packet:**

Protocol	Bytes	
ESP Trailer	12	
ESP Padding	varies (y)	encrypted
ESP Padding Header	2	encrypted
Voice Payload	varies (x)	encrypted
RTP	12	encrypted
UDP	8	encrypted
IP (original)	20	encrypted

Protocol	Bytes	
ESP header	8 + iv	
IP (tunnel)	20	
802.1Q VLAN Tagging	4	
MAC (incl. Preamble, FCS)	26	
<b>Total</b>	<b>112 + iv + x + y</b>	

### Length of the ESP Header

The length of the ESP header depends on the encryption algorithm used.

Required for Cipher Block Chaining. The ESP header contains an initialization vector (IV). The length of the IV is identical to the length of the cipher block.

### Padding

Padding is required, since the encryption algorithm is based on cipher block chaining. This means that the entire encrypted portion of the packet (original IP/UDP/ RTP header + voice payload+ESP header padding) must correspond to an integral multiple of the cipher block length.

Block length of the encryption algorithm:

Encryption Algorithm	Block length	Length of the initialization vector
AES	16 bytes (128 bit)	16 bytes (128 bit)
3DES	8 bytes (64 bit)	8 bytes (64 bit)

Calculation of the required padding bytes for voice packets:

$$(42 + x + y) \text{ (bytes)} = N \times (0 \text{ or } 16 \text{ (bytes)}) \text{ (N integer)}$$

### Bandwidth calculation for the AES encryption algorithm:

Codec	Packet parameters	Frame size (ms)	Payload (bytes)	Padding (Bytes)	Ethernet packet length (bytes)	Payload / Packet overhead ration	Ethernet load (incl.) header (kbps)
G.711	20	20	160	6	294	75%	117.6
G.711	30	30	240	6	372	50%	99.2
G.711	40	40	320	6	454	38%	90.8
G.711	60	60	480	6	614	25%	81.9
G.729A	1	20	20	2	150	600%	60.0
G.729A	2	40	40	6	182	300%	36.4
G.729A	3	60	60	2	198	200%	26.4

**Bandwidth calculation for the DES/3DES encryption algorithm:**

Codec	Packet parameters	Frame size (ms)	Payload (bytes)	Padding (Bytes)	Ethernet packet length (bytes)	Payload / Packet overhead ration	Ethernet load (incl.) header (kbps)
G.711	20	20	160	6	286	75%	114.4
G.711	30	30	240	6	366	50%	97.6
G.711	40	40	320	6	446	38%	89.2
G.711	60	60	480	6	606	25%	80.8
G.729A	1	20	20	2	142	600%	56.8
G.729A	2	40	40	14	166	300%	33.2
G.729A	3	60	60	10	182	200%	24.3

**Bandwidth for T.38 Fax**

Encryption Algorithm	Frame size (ms)	Payload y (bytes)	Padding x (bytes)	Ethernet packet length (bytes)	Payload packet (overhead in percent)	Ethernet load (incl.) header (kbps)
DES / 3DES	30	169	1	278	64%	74.1
AES	30	169	9	294	74%	78.3

### 19.3.2 Connecting Teleworkers via a VPN

Teleworkers can be connected to the communication system via a secure VPN connection.

**Stand-alone System with Integration of Teleworkers via a VPN**

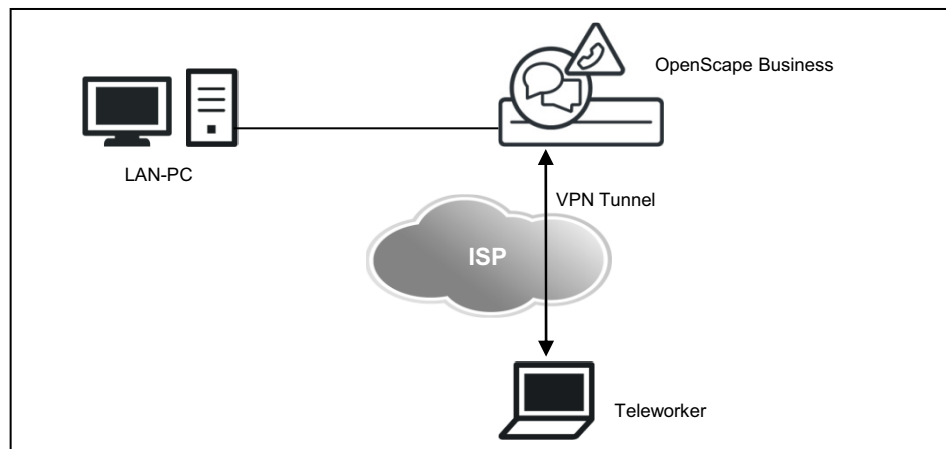



The communication system provides integrated VPN functionality (configured using a wizard). Per communication system, up to 10 teleworkers can be simultaneously active via a VPN connection.

The following VPN clients have been released for OpenScape Business:

- NCP VPN Client
- Shrew Soft VPN Client
- Android VPN Client
- iOS VPN Client
- Mac OS-X VPN Client

### **Exporting the Teleworker Data**

The teleworker data can be exported as a ZIP file (unencrypted). For each supported VPN client, the ZIP file contains a separate text file with the teleworker data. This is an `.ini` file for the NCP VPN client, a `.vpn` file for the Shrew Soft VPN Client and a `.networkConnect` file for the OS X VPN client. These text files can be imported at the VPN client.

---

**INFO:** Umlauts or accents in the text files with the teleworker data are ignored. Blanks are replaced by underscores.

---

### **Status Display of VPN Connections**

A status display of all VPN connections can be found in the **VPN** wizard. A detailed overview of all VPN connections can be found in the **Service Center** under **Diagnostics > Status > VPN Status**.

### **VPN with OpenScape Business S**

With OpenScape Business S, the VPN is terminated via an external router. The description of external applications is not part of this documentation.

## **19.3.2.1 How to Connect Teleworkers via a VPN**

The **VPN** wizard can be used to grant VPN teleworkers (VPN partners) access to the internal LAN and to connect communication systems via a VPN (virtual private network). If the communication system does not have any fixed external IP address (public IP address, global IP address), a DynDNS service will need to be configured (at [www.dyndns.org](http://www.dyndns.org), for example).

### **Prerequisites**

- Internet access via the WAN interface has been configured.
- If the WAN interface has no fixed (public) IP address, DynDNS must be configured. A connection to the Internet is required for a successful DynDNS test.
- You are logged on to the WBM with the **Advanced** profile.

### Step by Step

- 1) In the navigation bar, click on **Setup**.
- 2) In the navigation tree, click **Wizards > Network / Internet**.
- 3) Click **Edit** to start the **VPN Configuration** wizard. The default setting is **VPN is switched off**.
- 4) Click **Configuration of VPN**.
- 5) If you want to edit a configured VPN connection, click on **Edit** for the desired VPN connection.
- 6) If you want to create a new VPN connection, click on **Add**.
- 7) Enter a name for the VPN connection (e.g., `node2mch.dyndns.org`) in the **System name** field.
- 8) If desired, enter a **Comment** in the corresponding field.
- 9) Select the **enabled** check box (already preset by default).
- 10) Select the check box **Use Data of own System**.
- 11) If required, select the **Address Type**:
  - If the WAN interface has a fixed (public) IP address, select the entry **IP Address** from the **Address Type** drop-down list and enter the fixed (public) IP address under **Global Address / DNS Name (WAN)**.
  - If the WAN interface does not have a fixed (public) IP address, select the entry **DNS Name** from the **Address Type** drop-down list. The DNS name of the communication system that is already configured for DynDNS will be displayed under **Global Address / DNS Name (WAN)**.
- 12) The **Local IP Address (LAN)** should only be changed if required.
- 13) The **Local Subnet Mask (LAN)** should only be changed if required.
- 14) If you want to edit one of the already configured teleworkers, click on **Edit** next to the desired teleworker in the **Teleworkers** area.
- 15) If you want to create a new teleworker, click on **Add** in the **Teleworkers** area.
- 16) Enter a teleworker configuration name in the **Name** field.
- 17) Configure the type of the VPN client being used:
  - For pure IPsec VPN teleworkers (NCP and Shrew Soft VPN Clients):  
Clear the **L2TP/IPsec** check box and select the **IP Address** as **Address Type**. Enter a virtual IP address / DynDNS name for the teleworker in the field **Virtual IP address/DynDNS Name** if the VPN client being used supports virtual IP addresses (regardless of whether the teleworker has an Internet connection via a DSL router or DSL modem).
  - For L2TP/IPsec VPN teleworkers (iOS, Android and MAC OS X VPN clients):  
Select the **L2TP/IPsec** check box and assign a **User name** and a **Password** to the teleworker.
- 18) Select the **enabled** check box (already preset by default).

- 19) Click **OK**. The window with the overview of teleworkers is displayed again. You can enter further teleworkers.
- 20) When you have set up all teleworkers, click **OK & Next**. The **System Selection** window is displayed.
- 21) Click **OK & Next**. The **Security setup for connections** window appears.
- 22) To ensure a secure VPN connection, assign a key for the newly configured VPN connection under **PreShared Secret** and repeat it under **Repetition of the PreShared Secret**. The key must be at least 20 characters in length.
- 23) Enter a **Comment** if required.
- 24) Click **OK**. The **VPN Status Information** window appears.
- 25) Click on **Switch VPN on**.
- 26) Only if the address type DNS Name has been selected: Check the already configured data of the DynDNS account and click on **Connection test**. The DNS access data is now transmitted to the service provider. This procedure takes approximately 10 seconds. If the test is not successful, check your access data. After the test succeeds, click **OK**.
- 27) Click **OK & Next**. The teleworkers can now access the WAN interface of the communication system.
- 28) Click **Finish**.

### 19.3.2.2 How to Export Teleworker Data

You can export the teleworker data with the **VPN** wizard.

#### **Prerequisites**

- A VPN connection is configured.
- You are logged on to the WBM with the **Advanced** profile.

#### **Step by Step**

- 1) In the navigation bar, click on **Setup**.
- 2) In the navigation tree, click **Wizards > Network / Internet**.
- 3) Click **Edit** to start the **VPN Configuration** wizard. The default setting is **VPN is switched off**.
- 4) Click on **Export/Import**.
- 5) Click on **Export** in the **Export Teleworker Data from System** area. Save the ZIP file to a location of your choice.

---

**INFO:** For each supported VPN client, the ZIP file contains a separate file with the teleworker data. The teleworker data is not encrypted! Please take a responsible approach to the data.

---

- 6) Click **OK & Next** followed by **Finish**.

### 19.3.3 Networking Communication Systems via a VPN

Several OpenScope Business communication systems can be networked together securely using a site-to-site VPN network.

#### Networking via VPN

You can optionally configure all the data required for networking multiple systems on one communication system, encrypt and export this topology data and then import it on all other systems. This enables a fast and consistent configuration on all systems in the internetwork.

The distinction between the own system and the foreign systems occurs through the detection of the own DynDNS name or (when using fixed IP addresses) through the own Internet address.

- Exporting topology data from a system
  - All data about the topology of the VPN network is written to an encrypted XML file and provided as a ZIP export file for import into another system.
- Importing topology data into a system
  - All data about the topology of the VPN network can be imported from the ZIP file (with the encrypted XML file) and applied to this system.

The key (password) for export is freely selectable and must be communicated to any other administrator who may want to import these settings.

#### Status Display of VPN Connections

A status display of all VPN connections can be found in the **VPN** wizard. A detailed overview of all VPN connections can be found in the **Service Center** under **Diagnostics > Status > VPN Status**.

#### 19.3.3.1 How to Configure Networking via a VPN

The **VPN** wizard can be used to configure all communication systems which are connected to a system via VPN. This topology data can be exported and imported into all systems in the VPN internetwork.

##### *Prerequisites*

- Internet access via the WAN interface has been configured.
- If the WAN interface has no fixed (public) IP address, DynDNS must be configured. A connection to the Internet is required for a successful DynDNS test.
- You are logged on to the WBM with the **Advanced** profile.

## Step by Step

- 1) In the navigation bar, click on **Setup**.
- 2) In the navigation tree, click **Wizards > Network / Internet**.
- 3) Click **Edit** to start the **VPN Configuration** wizard. The default setting is **VPN is switched off**.
- 4) Click **Configuration of VPN**.
- 5) Click **Add**.
- 6) Enter a name for the first system in the VPN internetwork (e.g., `node1mch.dyndns.org`) in the **System name** field.
- 7) If desired, enter a **Comment** in the corresponding field.
- 8) Select the **enabled** check box (already preset by default).
- 9) Select the check box **Use Data of own System**. The following fields are automatically populated with the system data.
- 10) The preset **Address Type** should only be selected if required:
  - If the WAN interface has a fixed (public) IP address, select the entry **IP Address** from the **Address Type** drop-down list and enter the fixed (public) IP address under **Global Address / DNS Name (WAN)**.
  - If the WAN interface does not have a fixed (public) IP address, select the entry **DNS Name** from the **Address Type** drop-down list. The DNS name of the communication system that is already configured for DynDNS will be displayed under **Global Address / DNS Name (WAN)**.
- 11) The preset **Local IP Address (LAN)** should only be changed if required.
- 12) The preset **Local Subnet Mask (LAN)** should only be changed if required.
- 13) Click **OK & Next**. The **System Selection** window is displayed.
- 14) Click again on **Add**.
- 15) Enter a name for the second system in the VPN internetwork (e.g., `node2mch.dyndns.org`) in the **System name** field.
- 16) If desired, enter a **Comment** in the corresponding field.
- 17) Select the **enabled** check box (already preset by default).
- 18) Select the **Address Type** for the second system:
  - If the WAN interface has a fixed (public) IP address, select the entry **IP Address** from the **Address Type** drop-down list and enter the fixed (public) IP address under **Global Address / DNS Name (WAN)**.
  - If the WAN interface does not have a fixed (public) IP address, select the entry **DNS Name** from the **Address Type** drop-down list. The DNS name of the communication system that is already configured for DynDNS will be displayed under **Global Address / DNS Name (WAN)**.
- 19) Enter the **Local IP Address (LAN)** of the second system.
- 20) Enter the **Local Subnet Mask (LAN)** of the second system.

- 21) Click **OK & Next**. The **System Selection** window is displayed.
- 22) Repeat steps 14 through 21 for other systems in the VPN internetwork.
- 23) Then click **OK & Next**. The **Security setup for connections** window appears.
- 24) Assign a separate key for each VPN connection between systems under **PreShared Secret** and repeat it under **Repetition of the PreShared Secret**. The key must be at least 20 characters in length.
- 25) Enter a **Comment** for each VPN connection if required.
- 26) Click **OK**. The **VPN Status Information** window appears.
- 27) Click on **Export/Import** to export the topology data. The **Export and Import of VPN Configuration Data** window appears.
- 28) In the **Export Topology Data from System** area, specify a key (at least 7 digits) for backing up the data under **Key** and **Repeat Key** and then click on **Export**. Save the file to a location of your choice.
- 29) Click **OK & Next**.
- 30) Click on **Switch VPN on**.
- 31) Only if the address type **DNS Name** has been selected: Check the already configured data of the DynDNS account and click on **Connection test**. The DNS access data is now transmitted to the service provider. This procedure takes approximately 10 seconds. If the test is not successful, check your access data. After the test succeeds, click **OK**.
- 32) Click **OK & Next** followed by **Finish**.
- 33) In the WBM of the second system, click on **Setup** in the navigation bar and on **Wizards > Network / Internet** in the navigation tree.
- 34) Click **Edit** to start the **VPN Configuration** wizard. The default setting is **VPN is switched off**.
- 35) Click on **Export/Import** to import the topology data. The **Export and Import of VPN Configuration Data** window appears.
- 36) Click on **Import Topology Data to System** to import the topology data into the system.
- 37) Enter the **Key** (password) you used when exporting the data from the first system.
- 38) Navigate to the storage location of the ZIP file. Then click on **Import**.
- 39) Click **OK & Next**. You can see the configured systems.
- 40) Click on **Switch VPN on**.
- 41) Only if the address type **DNS Name** has been selected: Check the already configured data of the DynDNS account and click on **Connection test**. The DNS access data is now transmitted to the service provider. This procedure takes approximately 10 seconds. If the test is not successful, check your access data. After the test succeeds, click **OK**.
- 42) Click **OK & Next** followed by **Finish**.

- 43) Repeat steps 33 through 42 for the remaining systems in the VPN internetwork.

### 19.3.3.2 How to Import and Export the Topology Data of a VPN Network

The **VPN** wizard can be used to export and import the topology data of the VPN network.

#### *Prerequisites*

- A VPN connection is configured.
- In order to import the topology data, you will need to know the key that was assigned when exporting that data.
- You are logged on to the WBM with the **Advanced** profile.

#### *Step by Step*

- 1) In the navigation bar, click on **Setup**.
- 2) In the navigation tree, click **Wizards > Network / Internet**.
- 3) Click **Edit** to start the **VPN Configuration** wizard. The default setting is **VPN is switched off**.
- 4) Click on **Export/Import**.
- 5) If you want to export the topology data, in the **Export Topology Data from System** area, specify a key (at least 7 digits) for backing up the data under **Key** and **Repeat Key** and then click on **Export**. Save the file to a location of your choice.
- 6) If you want to import the topology data, in the **Import Topology Data to System** area, enter the key to decrypt the data under **Key** and then navigate to the storage location of the ZIP file. Then click on **Import**.
- 7) Click **OK & Next** followed by **Finish**.

### 19.3.4 VPN - Security Mechanisms

In VPN, the encryption of data occurs via different security mechanisms such as IPSec tunneling, Security Associations and authentication methods (peer-to-peer, digital signatures).

#### **IPSec Tunnels**

IPSec is used to encrypt data and can generally be implemented with and without tunnels. IPSec is an option for implementing VPN. You can encrypt the entire IP packet here with the IP header: this occurs in tunnel mode.

Tunnels must always be configured for both VPN peers.

IPSec supports the automatic key management system, Internet Key Exchange (IKE). This is a standard that is integrated in IPSec.

### **Security Associations SA**

A security association (SA) is an agreement between two communicating units in computer networks. It describes how the two parties will use security services to communicate securely with each other.

VPN connections always require three security associations (SA), negotiated in two phases:

- Phase 1 - Generating the IKE SA  
One for the initial mutual authentication and for exchanging the session keys (IKE-SA)
- Phase 2 - Negotiating the payload SAs  
One for each direction in the connection for payload traffic once established (payload SAs)

### **IKE SA**

The IKE protocol has essentially two different tasks. Start by creating a protocol used exclusively by the IKE protocol (IKE-SA). The existing IKE-SA is then used for secure negotiation of all further SAs (payload SA) for the transmission of payload data. IKE therefore operates in the two consecutive phases:

When setting up a call between VPN partners, various parameters must be negotiated (such as how often a key is regenerated or which encryption procedures are used). These parameters are stored and administered in IKE SAs.

### **Payload SA**

IKE phase 2 is used to negotiate all security parameters for the payload SAs between the VPN partners.

You always have to configure two SAs for transmission and receipt.

The following steps are essentially performed:

- Negotiating the algorithms for encryption and authentication
- Negotiating the security protocols used (ESP and AH)
- Negotiating the security protocol operating mode
- Negotiating the SA lifetime
- Defining the key material

### **Authentication**

Peer-to-peer communication in VPN. The following two types of authentication are possible for VPN peers:

- Pre-shared keys  
Pre-shared keys are also mostly used for VPN. A key pair is configured for both VPN partners for this. These keys form a "hash value" which is verified by the relevant partners for authentication purposes.



- Digital signatures  
Every VPN partner is assigned a certificate. For successful authentication, the VPN peers at both tunnel endpoints must check the digital signature of their peer against a trusted CA.

### **System-Specific Information**

The VPN parameters are principally administered via the wizard.

Note that the administrator connection must run via a secure connection with SSL.

- Security Associations SA  
The communication system supports Oakley groups 1, 2, and 5.
- IPSec  
The communication system uses IPSec tunnel mode with ESP (Encapsulating Security Payload). ESP is an IPSec protocol that guarantees packet encryption, packet integrity as well as packet authenticity
- Payload SA  
The communication system supports the encryption algorithms DES, 3DES, and AES  
Of all the MAC algorithms (MAC=Message Authentication Code) for authenticating data origin and data integrity, HMAC-SHA1, HMAC-SHA2, and HMAC-MD5 are supported.
- Recommended operating modes
  - IKE in "Main Mode" with Perfect Forward Secrecy
  - Hash function with SHA-2
  - Authentication with certificates (RSA)
  - Encryption with AES (up to 256 bits)
  - Support for dynamic public IP addresses via virtual IP addresses or DynDNS updating mechanisms for teleworker PCs

## **19.3.5 VPN - Certificates**

A certificate binds a specific public key to a specific VPN client. In this case, the client can be both a client of the communication system and a teleworker. The unique combination of public key and VPN client provides the basis for authentication.

### **Certificates and certificate authority**

Certificates are digitally signed and generated by a certificate authority (CA). IPSec accepts a certificate if it is issued by a trusted certificate authority.

In a simple VPN environment, the definition of an individual certificate authority may be sufficient; this CA operates as a trusted master certificate authority for the entire VPN and uses its self-signed CA certification for identification at all VPN clients.

Every VPN client needs one of the certificates issued by this CA.

Certificates based on the X.509 standard (the most widely used standard today) include the following main elements:

- information about the identity of the certificate owner
- the public key of the certificate owner,
- information about the CA that signed the certificate (a serial number, the validity period, information about the identity of the CA, and the digital signature of the CA)

### **Lightweight CA**

A Lightweight CA function helps with certification in environments where the customer is not already using a PKI. A Lightweight CA offers the following options:

- creating public/private key pairs
- signing and generating corresponding certificates
- saving key pairs with associated certificates in files

In cryptographic terms, a PKI (public key infrastructure) is a system for generating, distributing, and verifying digital certificates.

### **Certificate revocation lists (CRL)**

A critical situation occurs when a certificate has become known (or if this is suspected), and this certificate is hence no longer trustworthy for the peer authentication. In this case, the certificate authority must revoke the certificate and the revocation must be signaled to all peers as soon as possible. A remote peer's attempt to authenticate its identity using a revoked certificate is denied.

Basically, a CRL is a list of all revoked certificates. CRLs always have to be generated by the CA where the certificates originate.

A CRL contains the following main elements:

- a list of all revoked certificates; the certificates are identified by serial numbers
- the publication date for the next CRL updated (specifies the time to live for the CRL)
- information about the CA that generated the certificate (information on the identity of the CA and the digital signature of the CA)

The administrator must manually update and distribute the CRLs at regular intervals.

### **System-Specific Information**

Authentication is performed on the basis of cryptographic algorithms with public keys. The communication system supports RSA as the algorithm for cryptography with public keys. The communication system only supports certificates that correspond to the X.509 standard.

The communication system always operates as a VPN client for authentication.

- **Lightweight CA**  
The communication system offers restricted CA functionality (Lightweight CA). The administrator provides the key material for a system by manually importing private/public key pairs and certificates via the SSL-secured administration connection for all communication partners involved.

- CRL  
CRLs (certificate revocation lists) are used to revoke certificates. The CRL is imported into the communication system by the administrator via an SSL-protected connection.

### 19.3.5.1 VPN - How to Generate Lightweight CA Certificates

Lightweight CA is a licensed function for generating and managing CA and peer certificates.

#### **Prerequisites**

- You are logged into the WBM with the **Expert** profile.

#### **Step by Step**

- 1) In the navigation bar, click on **Expert Mode**.
- 2) In the navigation tree, click **Telephony > Security**.
- 3) Navigate in the menu tree to **VPN > Lightweight CA**. You can generate a CA certificate of your own in the **Generate Certificate** window.
- 4) Enter a name for the requested certificate under **Certificate Name**.
- 5) Enter a serial number of your choice under **Serial Number of the Certificate**

---

**INFO:** A serial number that has already been assigned cannot be used again for another certificate, since the serial numbers for all certificates that were ever created must be unique.

---

- 6) Under **Type of Signature Algorithm**, enter the desired algorithm for the certificate (sha256RSA or sha512RSA).
- 7) Under **Public Key Length**, enter the length of the public key (e.g., 2048).
- 8) Enter the date and time for the start of the validity period under **Start Time of Validity Period (GMT)**. The date specified is interpreted as Greenwich Mean Time (GMT).
- 9) Enter the date and time for the end of the validity period under **End Time of Validity Period (GMT)**.
- 10) Under **Subject Name**, enter the **Country (C)**, the **Organization (O)**, the **Organization Unit (OU)** and **Common Name (CN)**.
- 11) You can optionally also enter an alternative subject name under the **Subject Alternative Name** field. If you have done this, you will also need to select a format (e.g., IP address or DNS name). The input window depends on the selected format.
- 12) Enter the distribution point for the CRL lists ( listed in a drop-down menu) in the **CRL Distribution Point** field.
- 13) Click on **Generate Certificate**.

### 19.3.5.2 VPN - Certificate Management - How to View a Certificate

#### *Prerequisites*

- You are logged into the WBM with the **Expert** profile.

#### *Step by Step*

- 1) In the navigation bar, click on **Expert Mode**.
- 2) In the navigation tree, click **Telephony > Security**.
- 3) Navigate in the menu tree to **VPN > Certificate Management**. The **View Certificate From File** window appears.
- 4) Activate the **PKCS#12 Format** check box if required.
- 5) Enter the **Passphrase for decryption**.
- 6) Enter the certificate file under **File with Certificate** or select it using **Browse**.
- 7) Click on **Load**.

### 19.3.5.3 VPN - How to Import a Trusted CA Certificate (X.509)

X.509 is a standard for certificates. In this case, the name and digital signature of the issuer of the certificate are also saved in the certificate. X.509 is part of the X.500 directory service for world-wide, distributed, and open systems.

#### *Prerequisites*

- You are logged into the WBM with the **Expert** profile.

#### *Step by Step*

- 1) In the navigation bar, click on **Expert Mode**.
- 2) In the navigation tree, click **Telephony > Security**.
- 3) Navigate in the menu tree to **VPN > Certificate Management > Trusted CA Certificates > Configured Certificates**.
- 4) Enter a name for the requested certificate under **Certificate Name**.
- 5) Enter the certificate file under **File with Certificate** field or select a certificate file using **Browse**.
- 6) Confirm and click on **Activate the Configured VPN Tables**.

### 19.3.5.4 VPN - Peer Certificates - How to Generate a Certificate Signing Request (CSR)

You can generate a CA-signed peer certificate based on a CA certificate. This requires at least one CA certificate to have already been generated. The certificate generated is saved in a PKCS#12 file. PKCS#12 files (Personal Information Exchange Syntax Standard) save certificates with the private key. A

PKCS#12 file therefore contains the necessary data for personal encryption and decryption.

### ***Prerequisites***

- You are logged into the WBM with the **Expert** profile.

### ***Step by Step***

- 1) In the navigation bar, click on **Expert Mode**.
- 2) In the navigation tree, click **Telephony > Security**.
- 3) Navigate in the menu tree to **VPN > Peer Certificates**.
- 4) Enter the required data on the **Generate Certificate Signing Request (CSR)** tab.
- 5) Enter the **Certificate Request Name**.
- 6) Enter the desired algorithm (sha256RSA or sha512RSA) under **Type of Signature Algorithm**.
- 7) Enter the key length (2048) under **Key Length**.
- 8) Under **Subject Name** enter all the relevant data for **Country (C)**, **Organization (O)**, **Organization Unit (OU)** and **Common Name (CN)**.
- 9) Under **Subject Alternative Name**, enter the **Distinguished Name Format**, any possible **Other Format** or an **Alternative Subject Name**.
- 10) Save the \*.csr file to be signed by a CA.

## **19.3.5.5 VPN - Peer Certificates - How to Generate a Certificate (PKCS#12)**

### ***Prerequisites***

- You are logged into the WBM with the **Expert** profile.

### ***Step by Step***

- 1) In the navigation bar, click on **Expert Mode**.
- 2) In the navigation tree, click **Telephony > Security**.
- 3) Navigate in the menu tree to **VPN > Lightweight CA**.
- 4) Click on the CA certificate and then on **Generate CA-Signed Peer Certificate [PKCS#12]**.
- 5) Enter the **Passphrase for decryption**.
- 6) Enter a serial number of your choice under **Serial Number of Certificate**.
- 7) Enter the key length (1024, 1536 or 2048) under **Key Length**.
- 8) Enter the date and time for the start of the validity period under **Start Time of Validity Period (GMT)**. The specified date and time is in Greenwich Mean Time.

---

**INFO:** The validity period of the peer certificate must be carefully adapted to comply with the applicable security guidelines in the company. Shortly before the validity period expires, the certificate must be extended or a new certificate must be issued.

---

- 9) Enter the date and time for the end of the validity period under **End Time of Validity Period (GMT)**.
- 10) Under **Subject Name** enter all the relevant data for **Country (C)**, **Organization (O)**, **Organization Unit (OU)** and **Common Name (CN)**.
- 11) You can optionally also enter an alternative subject name under the **Subject Alternative Name** field. If you have done this, you will also need to select a format (e.g., IP address or DNS name). The input window depends on the selected format.
- 12) Enter the **CRL Distribution Point** (optional).
- 13) Click on **Generate Certificate**.

### 19.3.5.6 VPN - How to Import a Peer Certificate (PKCS#12)

PKCS#12 files (Personal Information Exchange Syntax Standard) save certificates with the private key. A PKCS#12 file thus contains the essential data for personal encryption and decryption.

#### *Prerequisites*

- You are logged into the WBM with the **Expert** profile.

#### *Step by Step*

- 1) In the navigation bar, click on **Expert Mode**.
- 2) In the navigation tree, click **Telephony > Security**.
- 3) Navigate in the menu tree to **VPN > Peer Certificates**.
- 4) Click on the **Import Peer Certificate (PKCS#12)** tab.
- 5) Enter a name for the requested certificate under **Name of the Certificate**.
- 6) Under **Passphrase for decryption**, enter your personal password for decrypting this certificate.
- 7) Enter the file name under **File with Certificate** or locate the file by using the **Browse** button.
- 8) Click on **View Fingerprint of Certificate**.
- 9) Click on **Import Certificate from File**.

## 19.3.6 VPN Clients

Teleworkers can establish a secure VPN connection to the corporate network using a VPN tunnel over the Internet. To do this, a VPN client must be installed on their device (PC, tablet PC, smartphone). All data transmitted between the VPN client, the corporate firewall and the VPN server of the communication system is encrypted.

The following VPN clients are supported:

- **NCP VPN Client**  
NCP clients can be used in any VPN environments with IPsec. This is significant if access is required from a remote PC to VPN gateways of different manufacturers or if a central VPN gateway from a third-party vendor is already installed in the company network. In the case of a branch office network, the NCP Secure Enterprise Gateway can be used with other VPN gateways on the basis of IPsec connections.  
The NCP client is not free, but it offers the benefits of a graphical user interface and a status indicator for the connection.
- **Shrew Soft VPN Client**  
The Shrew Soft VPN Client is a free VPN client with a graphical user interface that supports version 2.1.5 and hybrid authentication.  
The Shrew Soft VPN client includes, among other things, ISAKMP, Xauth and RSA support, AES, Blowfish and 3DES encryption protocols, and numerous other features that are usually found only in professional solutions.
- **iOS and Android VPN Client**  
The L2TP/IPsec VPN client is integrated in the iOS or Android operating system.  
The L2TP/IPsec VPN clients use the IP address range `10.254.253.x`. If IP addresses from this range are already being used in the customer network, the IP address range needs to be changed in the WBM (e.g., from `10.254.253.1` to `10.254.252.1`) via **Expert mode > Maintenance > Application Diagnostics > IPsec Test: IPsec Test Routines > Set IP Address for L2TP**.
- **Mac OS-X VPN Client**  
The Mac OS X VPN client is integrated in the MAC OS X operating system.

### System-Specific Information

- The teleworker data of a VPN client can be exported as a ZIP file (unencrypted). For each supported VPN client, the ZIP file contains a separate text file with the teleworker data. This is an `.ini` file for the NCP VPN client, a `.vpn` file for the Shrew Soft VPN Client and a `.networkConnect` file for the OS X VPN client. These text files can be imported at the VPN client.
- LAN infrastructure with multiple subnets  
If VPN is to be used for a LAN infrastructure with multiple subnets, it is necessary to create rules for these subnets. These rules cannot be created via wizards, but must be configured in Expert mode.

- Tunnel in Tunnel  
It is not possible create a second VPN tunnel through an already existing VPN tunnel.

### 19.3.6.1 NCP VPN Client Settings

VPN connections via the NCP VPN client require the following settings if the configuration is to be performed manually. You can export a text file with the configured VPN client data (`ncp_vpn.ini`) from your communication system and import it into the VPN client. This ensures that the respective configuration settings are populated automatically.

#### Basic Settings

- Profile name  
freely selectable; use of meaningful names recommended
- Connection type  
VPN to IPSec peer
- Connection medium  
In accordance with the Internet connection used  
e.g., LAN (over IP) or xDSL (PPPoE)

#### Dialing into network

No configuration required.

#### HTTP Login

No configuration required.

#### Modem

No configuration required.

#### Line Management

- Call setup  
automatic or manual  
Timeout = 0

---

**INFO:** This ensures the connection is not cleared due to idle time!

---

- Prioritizing Voice over IP (VoIP)  
Set check mark
- EAP Authentication  
No configuration required
- HTTP authentication  
No configuration required



### **IPSec Settings**

- Gateway = IP address or DNS name of the communication system  
The communication system can be reached via the Internet under this IP address or DNS name.  
Designation in the VPN wizard: **IP Address/DynDNS Name**
- IKE Policy = Unattended Mode
- IPSec Policy = Unattended Mode
- Exchange Mode = Main Mode
- PFS Group = DH Group 2 (1024 bits)
- Validity / Duration
  - IKE Policy: 000:00:07:00 (7 minutes)
  - IPSec Policy: 000:00:08:00 (8 minutes)
- Editor  
No configuration required

### **Advanced IPSec Options**

No configuration required

### **Identity**

- Type = IP address  
ID = IP address of the teleworker PC (see also: Assigning IP addresses)  
Use Pre-shared key  
Set check mark  
Shared Secret = This is the password for the VPN connection  
Designation in the VPN wizard: **PreShared Secret**
- Extended Authentication (XAUTH)  
not used, no configuration required

### **IP address assignment**

- Assign IP address manually  
IP address = IP address of the teleworker PC  
Designation in the VPN wizard: **IP Address/DynDNS Name**
- DNS / WINS  
Set check mark
- DNS server = IP address of the communication system  
Designation in the VPN wizard: **Local IP Subnet Address (LAN)**

### **VPN - IP Networks**

No configuration required.

### **Certificate check**

No configuration required

**Link Firewall**

- Activate Stateful Inspection:  
for existing connection
- Allow only communication in the tunnel:  
Set check mark

**19.3.6.2 How to Configure an NCP VPN Client**

An NCP VPN client must be installed and configured on the teleworker device for a secure VPN connection to the communication system.

***Prerequisites***

- The administrator of your communication system has set you up as a teleworker in the WBM of OpenScape Business and made the export ZIP file with the teleworker data available to you.
- The administrator of your communication system has communicated the PreShared Secret Key for the VPN connection to you.
- The NCP VPN client (LANCOM Advanced VPN Client) is installed on the teleworker device. The information required for this can be found in the documentation of the NCP VPN client.
- The teleworker device has an existing and active connection to the Internet.

***Step by Step***

- 1) Extract the files `ncp_readme.txt` and `ncp_vpn.ini` and place them in a local directory. The entries in the `ncp_vpn.ini` file refer to the `HOOME` profile.
- 2) Import the `HOOME` profile into the NCP VPN client.
- 3) Extend the `HOOME` profile with a DNS server. The address of the DNS server is the private IP address (LAN) of your communication system.
- 4) Start the NCP VPN client
- 5) Select the `HOOME` profile and click on **Connect**.

**19.3.6.3 How to Configure a Shrew Soft VPN Client**

A Shrew Soft VPN Client must be installed and configured on the teleworker device for a secure VPN connection to the communication system.

### **Prerequisites**

- The administrator of your communication system has set you up as a teleworker in the WBM of OpenScape Business and made the export ZIP file with the teleworker data available to you.
- The administrator of your communication system has communicated the PreShared Secret Key for the VPN connection to you.
- The Shrew Soft VPN Client is installed on the teleworker device. A download for the Shrew Soft VPN client can be found under <http://www.shrew.net>.
- The teleworker device has an existing and active Internet connection.

### **Step by Step**

- 1) Extract the files `shrewsoft_readme.txt` and `shrewsoft_openswan.vpn` and place them in a local directory.
- 2) Start the **Shrew Soft VPN Client Access Manager** and configure it. Save the entries.
- 3) Import the file `shrewsoft_openswan.vpn` into the Shrew Soft client.
- 4) You should then see the connection in the **Shrew Soft Client VPN Access Manager** under **Connect**.

## **19.3.6.4 How to Configure an iOS or Android VPN Client**

An L2TP VPN connection must be configured on the teleworker device for a secure VPN connection to the communication system.

### **Prerequisites**

- The administrator of your communication system has configured you as a teleworker in the WBM of OpenScape Business and has communicated the user name, the password and the PreShared secret key for the VPN connection to you.
- The teleworker device has an existing and active connection to the Internet.

### **Step by Step**

- 1) Open the **Settings > General > VPN** menu on the iOS or Android teleworker device.
- 2) Click on **Add VPN** to add a new VPN connection.
- 3) Click on the **L2TP** tab.
- 4) Enter a name for the VPN connection in the **Description** field.
- 5) Enter the public IP address or the DNS name of the communication system in the **Server** field.
- 6) Enter the teleworker user name in the **Account** field.

- 7) Enter the teleworker password in the **Password** field.
- 8) Enter the PreShared secret key for the VPN tunnel in the **Shared Secret** field.
- 9) Enable the **For all data** option.
- 10) Select the **VPN** option in the **Settings** menu.

### 19.3.6.5 How to Configure a Mac OS X VPN Client

An L2TP VPN connection must be configured on the teleworker device for a secure VPN connection to the communication system.

#### *Prerequisites*

- The administrator of your communication system has set you up as a teleworker in the WBM of OpenScape Business and made the export ZIP file with the teleworker data available to you.
- The administrator of your communication system has communicated the user name, the password and the PreShared secret key for the VPN connection to you.
- The teleworker device has an existing and active connection to the Internet.

#### *Step by Step*

- 1) Extract the file `.networkConnect` and place it in a local directory.
- 2) Double-click on the file `.networkConnect`.
- 3) Click on **VPN (L2TP)**.
- 4) Select the VPN connection in the **Configuration** field.
- 5) Enter the public IP address or the DNS name of the communication system in the **Server Address** field.
- 6) Enter the teleworker user name in the **User Name** field.
- 7) Set the security settings:
  - a) Click **Authentication Settings**.
  - b) Enter the teleworker password in the **Password** field.
  - c) Enter the PreShared secret key for the VPN tunnel in the ("**Shared Secret**") **Key** field.
  - d) Click **OK**.
- 8) Click on **More Options** and select the **Send all traffic over VPN connection** check box. Then click **OK**.
- 9) Click on **Apply**, followed by **Connect**. Once the connection to the OpenScape Business has been established successfully, the connection status will be shown as **Connected**.

## 19.3.7 VPN Services

You can manage services via the Configured Services function. Configured services become active services only on activation.

### 19.3.7.1 VPN - Active Services - How to Display all IPsec Services

A list of all active IPsec services with detailed information can be displayed in the form of a table.

#### *Prerequisites*

- You are logged into the WBM with the **Expert** profile.

#### *Step by Step*

- 1) In the navigation bar, click on **Expert Mode**.
- 2) In the navigation tree, click **Telephony > Security**.
- 3) Navigate in the menu tree down to **VPN > Services > Active Services**.
- 4) You can view the relevant details for the active IPsec services under the **Display IPsec Services** tab.

### 19.3.7.2 VPN - Active Services - How to Display a Special IPsec Service

#### *Prerequisites*

- You are logged into the WBM with the **Expert** profile.

#### *Step by Step*

- 1) In the navigation bar, click on **Expert Mode**.
- 2) In the navigation tree, click **Telephony > Security**.
- 3) Navigate in the menu tree down to **VPN > Services > Active Services**.
- 4) Click in the menu tree on the special service for which you want to view all the information (**Name of the Service, Source Port, Destination Port, IP Protocol, Associated 'pass' Rule, Associated 'deny' Rule**).

### 19.3.7.3 VPN - Configured Services - How to Display all IPsec Services

A list of all configured IPsec services with detailed information can be displayed in the form of a table.

### **Prerequisites**

- You are logged into the WBM with the **Expert** profile.

### **Step by Step**

- 1) In the navigation bar, click on **Expert Mode**.
- 2) In the navigation tree, click **Telephony > Security**.
- 3) Navigate in the menu tree down to **VPN > Services > Configured Services**.
- 4) You can view the relevant details for the configured IPsec services under the **Display IPsec Services** tab.

## **19.3.7.4 VPN - Configured Services - How to Edit the IPsec Service**

### **Prerequisites**

- You are logged into the WBM with the **Expert** profile.

---

**INFO:** Before editing and/or enabling the IPsec service, a backup should be performed. IPsec rules behave like firewall entries and can restrict access to the system. If a situation arises in which you have enabled IPsec and can then no longer access the system, you can reset the communication system with **Reload**.

---

### **Step by Step**

- 1) In the navigation bar, click on **Expert Mode**.
- 2) In the navigation tree, click **Telephony > Security**.
- 3) Navigate in the menu tree down to **VPN > Services > Configured Services**.
- 4) Click on the special service that you want to edit in the menu tree.
- 5) Edit the name of the service under **Name of the Service**.
- 6) Change the source port under **Source Port**.
- 7) Change the destination port under **Destination Port**.
- 8) Change the service (e.g., UDP) under **IP Protocol den Service**.
- 9) After the entire VPN configuration, the change is applied with **Activate the Configured VPN Tables**.

## **19.3.7.5 VPN - Configured Services - How to Rename the IPsec Service**

### **Prerequisites**

- You are logged into the WBM with the **Expert** profile.

### *Step by Step*

- 1) In the navigation bar, click on **Expert Mode**.
- 2) In the navigation tree, click **Telephony > Security**.
- 3) Navigate in the menu tree down to **VPN > Services > Configured Services**.
- 4) Click on the special service that you want to rename in the menu tree.
- 5) Edit the name of the service under **Name of the Service**.
- 6) After the entire VPN configuration, the change is applied with **Activate the Configured VPN Tables**.

## 19.3.7.6 VPN - Configured Services - How to Delete the IPsec Service

### *Prerequisites*

- You are logged into the WBM with the **Expert** profile.

### *Step by Step*

- 1) In the navigation bar, click on **Expert Mode**.
- 2) In the navigation tree, click **Telephony > Security**.
- 3) Navigate in the menu tree down to **VPN > Services > Configured Services**.
- 4) Click on the special service that you want to delete in the menu tree.
- 5) After the entire VPN configuration, the change is applied with **Activate the Configured VPN Tables**.

## 19.3.8 VPN tunnel

Tunnel is the term used to describe the transportation of encrypted data packets to a defined endpoint. Active tunnels become configured tunnels when the configuration is enabled. A maximum of 256 tunnels can be set up per gateway.

### 19.3.8.1 VPN - Active Tunnels - How to Display General Tunnel Data

You can view all active tunnels in tabular form with detailed information on them.

### *Prerequisites*

- You are logged into the WBM with the **Expert** profile.

### *Step by Step*

- 1) In the navigation bar, click on **Expert Mode**.
- 2) In the navigation tree, click **Telephony > Security**.

- 3) Navigate in the menu tree to **VPN > Tunnels > Active Tunnels**.
- 4) Under the **Display General Tunnel Data** tab you can view detailed information on each active tunnel. This includes:

- Name of the Tunnel**
- State in IP Stack**
- Endpoint type of the local tunnel**
- Local Tunnel Endpoint Address**
- Type of the Remote Tunnel Endpoint**
- Remote Tunnel Endpoint Address**
- Suggested Lifetime of the Session Keys**
- Suggested Lifetime of the Key Exchange Session**
- Associated Rules: Associated Transmit Rule**
- Associated Rules: Associated Receive Rule**

### 19.3.8.2 VPN - Active Tunnels - How to Display Rules for all Tunnels

You can have the rules for all active tunnels displayed in a window.

#### *Prerequisites*

- You are logged into the WBM with the **Expert** profile.

#### *Step by Step*

- 1) In the navigation bar, click on **Expert Mode**.
- 2) In the navigation tree, click **Telephony > Security**.
- 3) Navigate in the menu tree to **VPN > Tunnels > Active Tunnels**.
- 4) On the **Display Rules for all Tunnels** tab, you will see detailed information on each active tunnel such as

- Tunnel Data**
- Rule Data**
- Source Address**
- Destination Address**
- Service Data**

### 19.3.8.3 VPN - Configured Tunnels - How to Display General Tunnel Data

You can view all the data for configured tunnels in tabular form with detailed information on them.

#### *Prerequisites*

- You are logged into the WBM with the **Expert** profile.



### **Step by Step**

- 1) In the navigation bar, click on **Expert Mode**.
- 2) In the navigation tree, click **Telephony > Security**.
- 3) Navigate in the menu tree to **VPN > Tunnels > Configured Tunnels**.
- 4) Under the **Display General Tunnel Data** tab you can view detailed information on each configured tunnel. This includes:

**Name of the Tunnel**

**Endpoint type of the local tunnel**

**Local Tunnel Endpoint Address**

**Type of the Remote Tunnel Endpoint**

**Remote Tunnel Endpoint Address**

**Suggested Lifetime of the Session Keys**

**Suggested Lifetime of the Key Exchange Session**

**Associated Rules: Associated Transmit Rule**

**Associated Rules: Associated Receive Rule**

## **19.3.8.4 VPN - Configured Tunnels - How to Display Rules for all Tunnels**

You can have the rules for all configured tunnels displayed in a window.

### **Prerequisites**

- You are logged into the WBM with the **Expert** profile.

### **Step by Step**

- 1) In the navigation bar, click on **Expert Mode**.
- 2) In the navigation tree, click **Telephony > Security**.
- 3) Navigate in the menu tree to **VPN > Tunnels > Configured Tunnels**.
- 4) On the **Display Rules for all Tunnels** tab, you will see detailed information on each configured tunnel such as

**Tunnel Data**

**Rule Data**

**Source Data**

**Destination Data**

**Service Data**

## **19.3.8.5 VPN - How to Add a Configured Tunnel**

You can add a new IPsec tunnel. A maximum of 256 tunnels can be set up per gateway.

### Prerequisites

- You are logged into the WBM with the **Expert** profile.

### Step by Step

- 1) In the navigation bar, click on **Expert Mode**.
- 2) In the navigation tree, click **Telephony > Security**.
- 3) Navigate in the menu tree to **VPN > Tunnels > Configured Tunnels**.
- 4) The input window for the new tunnel can be found on the **Add Tunnel** tab.
- 5) Select **Tunnel Data**.
- 6) Enter the desired name for the new tunnel under **Name-of-the-Tunnel**.
- 7) In the **Type of the Local Tunnel Endpoint** drop-down list, select the endpoint address type at the sending end of the tunnel; you can specify a host name or a DNS name.
- 8) Under **Local Tunnel Endpoint Address**, enter the sender address in a format suitable for the endpoint type.
- 9) In the **Type of the Remote Tunnel Endpoint** drop-down list, select the type of the endpoint address on the receiving end of the tunnel (only the IP address is currently supported).
- 10) Under **Remote Tunnel Endpoint Address**, enter the recipient address in a format suitable for the endpoint type. In this field, 0.0.0.0 indicates that the tunnel endpoint is unknown. In this case, the tunnel must be configured by the peer (e.g. teleworker).
- 11) Under **Session Key Handling**, specify the procedure for the key exchange (possible entry: Automatically, using IKE protocol).
- 12) Select which algorithms (AES or 3DES) may be used under **Suggested Encryption Algorithms**.
- 13) Select which hash algorithms may be used under **Suggested Hash Algorithms** (MD5, SHA1 or SHA2). The selected algorithms are offered by the initiator of IKE negotiation.
- 14) Enter the validity period for the session keys to be used under **Suggested Lifetime of the Session Keys**. When this period expires, no more data is exchanged within this session. New session keys are automatically negotiated to replace keys that have become invalid.
- 15) Enter a validity period under **Suggested Lifetime of the Key Exchange Session**. Once the key exchange session has expired, new keys are automatically negotiated using the IKE protocol.
- 16) Enter the maximum data volumes for the session keys under **Suggested Data Volume of the Session Keys**. If the data volume is exceeded, new session keys are automatically negotiated using the IKE protocol. If you select **unlimited**, the validity of the session keys will not be limited by the volume of data.

- 17) Activate the **Key Exchange Data** check box in the upper section of the window.
- 18) Enter all the key exchange data (**activate 'Perfect Forward Secrecy' and select the VPN Peer Authentication Method (Pre-Shared-Key or Digital signatures)**).

---

**INFO:** If you have selected **Pre-shared keys** as the authentication method, you will need to enter a 20-character pre-shared key (and repeat this).

---

---

**INFO:** If you want to use **Digital signatures** (from a Lightweight CA) as the authentication method in a VPN network with multiple nodes, you will need to complete some additional configuration steps.

---

- a) Create an LWCA certificate at a node.
  - b) Export the certificate (.crt) to a file.
  - c) Create and export a certificate revocation list (.crl) to a file.
  - d) Create and export a peer certificate (.p12) that is signed by a CA for every node.
  - e) The CA certificate (.crt), the certificate revocation list (.CRL) and the corresponding peer certificates must be imported into every node.
- 19) Enter the **Suggested Diffie-Hellman Groups** (DH Group 2, 5 or 14).
  - 20) After the entire VPN configuration, the change is applied with **Activate the Configured VPN Tables**.

## 19.3.9 VPN rules

Rules define how IP packets are to be handled. The rule action *Pass* means that the IP packet is to be transported further (passed through). The rule action *Deny* means that the IP packet will not be transported further (i.e., will be ignored). You can also select whether or not the IP packet will use an encrypted VPN tunnel.

The communication system can manage 640 rules, of which 6 rules are preset (default rules) and 634 are free for allocation.

### 19.3.9.1 VPN - Active Rules - How to Display Rules

You can have all rules displayed.

#### **Prerequisites**

- You are logged into the WBM with the **Expert** profile.

### ***Step by Step***

- 1) In the navigation bar, click on **Expert Mode**.
- 2) In the navigation tree, click **Telephony > Security**.
- 3) Navigate in the menu tree to **VPN > Rules > Active Rules**.
- 4) Click on the **Display Rules** tab. You will then see detailed information on the active rules such as
  - Priority**
  - Service**
  - Rule-Based Action**
  - Encryption Required**
  - Rule State**
  - State in IP Stack**
  - Source Address**
  - Destination Address**
  - Tunnels for Encryption**

## **19.3.9.2 VPN - Active Rules - How to Display Special Rules**

### ***Prerequisites***

- You are logged into the WBM with the **Expert** profile.

### ***Step by Step***

- 1) In the navigation bar, click on **Expert Mode**.
- 2) In the navigation tree, click **Telephony > Security**.
- 3) Navigate in the menu tree to **VPN > Rules > Active Rules**.
- 4) Click on the desired rule in the menu tree. The **Display Rule** window appears with all the details for this rule (**priority, service, rule-based action, encryption required, rule state, source address, destination address**)

## **19.3.9.3 VPN - Configured Rules - How to Display all Rules**

### ***Prerequisites***

- You are logged into the WBM with the **Expert** profile.

### ***Step by Step***

- 1) In the navigation bar, click on **Expert Mode**.
- 2) In the navigation tree, click **Telephony > Security**.
- 3) Navigate in the menu tree to **VPN > Rules > Configured Rules**.

- 4) Click on the **Display Rules** tab. You will then see detailed information on the active rules such as
  - Priority**
  - Service**
  - Rule-Based Action**
  - Encryption Required**
  - Enable Rule**
  - Source Address (type and IP address)**
  - Destination Address (type and IP address)**

### 19.3.9.4 VPN - Configured Rules - How to Add a Rule

#### *Prerequisites*

- You are logged into the WBM with the **Expert** profile.

#### *Step by Step*

- 1) In the navigation bar, click on **Expert Mode**.
- 2) In the navigation tree, click **Telephony > Security**.
- 3) Navigate in the menu tree to **VPN > Rules > Configured Rules > Add Rule**.
- 4) Make the settings for the following parameters:
  - Priority**
  - Service**
  - Rule-Based Action (PASS, PASS\_INCOMING, PASS\_OUTGOING, DENY)**
  - Encryption Required**
  - Rule Status**
  - Source Address - Type**
  - Source Address - Address (Lowest IP Address in Range)**
  - Source Address - Subnet Mask (Highest IP Address in Range)**
  - Destination Address - Type**
  - Destination Address - Address (Lowest IP Address in Range)**
  - Destination Address - Subnet Mask (Highest IP Address in Range)**
  - Tunnel on Receive Side**
  - Tunnel on Transmit Side**
- 5) Click on **Apply**.

### 19.3.9.5 VPN - How to Edit a Rule

#### *Prerequisites*

- You are logged into the WBM with the **Expert** profile.

#### *Step by Step*

- 1) In the navigation bar, click on **Expert Mode**.
- 2) In the navigation tree, click **Telephony > Security**.
- 3) Navigate in the menu tree to **VPN > Rules > Configured Rules**.
- 4) Select the rule to be modified in the menu tree.
- 5) Enter the priority under **Priority**.
- 6) Enter the service (e.g., DNS) under **Service**.
- 7) Specify the rule (**PASS**, **PASS\_INCOMING**, **PASS\_OUTGOING**, **DENY**) under **Rule-Based Action**.
- 8) Enable the **Encryption Required** check box if required.
- 9) Select the check box **Enable Rule**.
- 10) Under **Source Address**, enter the **Type** and **IP** address for the edited rule.
- 11) Under **Destination Address**, enter the **Type** and **IP** address for the edited rule.
- 12) After the entire VPN configuration, the change is applied with **Activate the Configured VPN Tables**.

### 19.3.9.6 VPN - How to Add a Rule for the Opposite Direction

When an IPSec rule is created for a transmissions in one direction, the rule for the opposite direction should be added immediately thereafter. The function "Add Rule for the Opposite Direction" copies over the entries of the selected rule, while swapping the source and destination addresses and switching the tunnel assignment accordingly.

#### *Prerequisites*

- You are logged into the WBM with the **Expert** profile.

#### *Step by Step*

- 1) In the navigation bar, click on **Expert Mode**.
- 2) In the navigation tree, click **Telephony > Security**.
- 3) Navigate in the menu tree to **VPN > Rules > Configured Rules**.
- 4) Select the rule to be edited in the menu tree.
- 5) Click on the **Add Rule for Opposite Direction** tab.

- 6) Click on **Apply**.
- 7) After the entire VPN configuration, the change is applied with **Activate the Configured VPN Tables**.

### 19.3.9.7 VPN - How to Delete a Rule

#### *Prerequisites*

- You are logged into the WBM with the **Expert** profile.

#### *Step by Step*

- 1) In the navigation bar, click on **Expert Mode**.
- 2) In the navigation tree, click **Telephony > Security**.
- 3) Navigate in the menu tree to **VPN > Rules > Configured Rules**.
- 4) Select the rule to be deleted in the menu tree.
- 5) Click on the **Delete Rule** tab. The selected rule with all data is displayed.
- 6) Click on **Delete**. You will receive a warning that you are about to delete this rule.
- 7) After the entire VPN configuration, the change is applied with **Activate the Configured VPN Tables**.

### 19.3.10 PKI Server

The PKI server designates a server that can issue, distribute and verify digital certificates. The certificates issued within a PKI (Public Key Infrastructure) are used to protect communications.

When using certificates (digital signatures), an attempt is made to download the CRL via the PKI URL configured by the PKI server.

#### 19.3.10.1 VPN - How to Display the PKI Server

#### *Prerequisites*

- You are logged into the WBM with the **Expert** profile.

#### *Step by Step*

- 1) In the navigation bar, click on **Expert Mode**.
- 2) In the navigation tree, click **Telephony > Security**.
- 3) Navigate in the menu tree down to **VPN > Public Key Infrastructure (PKI)**.

- 4) Click on the **Display PKI Servers** tab. The **Name of the PKI Server**, the **PKI Server Type** and the **URL of the PKI Server** are displayed.

### 19.3.10.2 VPN - How to Add a PKI Server

#### *Prerequisites*

- You are logged into the WBM with the **Expert** profile.

#### *Step by Step*

- 1) In the navigation bar, click on **Expert Mode**.
- 2) In the navigation tree, click **Telephony > Security**.
- 3) Navigate in the menu tree down to **VPN > Public Key Infrastructure (PKI)**.
- 4) Click on the **Add PKI Server** tab.
- 5) Enter the **Name of the PKI Server**.
- 6) Enter the **PKI Server Type** (e.g., LDAP).
- 7) Enter the **URL of the PKI Server**.
- 8) Confirm your entries and click **Apply**.

## 19.4 Certificate Handling

Certificate handling (for Secure Sockets Layer, SSL) promotes the reliable administration of the communication system. The data cannot be read or manipulated by unauthorized parties. Certificates are used for authorization. You can generate and administer certificates.

Administrative access is encrypted over HTTPS using the TLS 1.2 protocol. Certificates are used to authenticate the communication system. By default, a self-signed certificate is used. A customer-specific certificate can be used to enhance security.

SSL supports the following security services:

- Authenticity (the communication partner is who he says he is)
- Trustworthiness (the data cannot be read by a third party)
- Integrity (the data was received in the same condition as it was sent)

These security services demand prior agreement on the security mechanism used and the exchange of cryptographic keys. These two tasks are performed in the course of connection setup.

SSL uses certificates and keys to guarantee secure data transmission.

#### **CRL (Certificate Revocation List)**

Certificate Revocation Lists (CRL) are files containing a list of blocked certificates, their serial number, and their blocking data. A CRL list also contains the name of



the party who issued the certificate revocation list and the next authentication time.

### **CDP (CRL Distribution Point)**

The CRL Distribution Point (CDP) is the directory (location) where the current versions of the CRLs are located (for example, <http://sectestcal.microsoft.com/ErtEnvoll/SecTestCAL.crl>).

### **System-Specific Information**

Client/server communication in SSL-based administration.

The server uses the certificates generated or imported by the WBM for authentication at the client. Such certificates can be imported into the browser as trusted certificates to avoid warning messages in the browser when connecting to the SSL server.

---

**INFO:** The SSL certificate generation can also be used for SPE.

---

## **19.4.1 How to Generate CA Certificates**

### ***Prerequisites***

- You are logged into the WBM with the **Expert** profile.

### ***Step by Step***

- 1) In the navigation bar, click on **Expert Mode**.
- 2) In the navigation tree, click **Telephony > Security**.
- 3) Navigate in the menu tree down to **SSL > Certificate Generation**.
- 4) Click on the **Generate CA Certificate** tab.
- 5) Specify the **Name of the Certificate**.
- 6) Enter a serial number also in the field **Serial Number of Certificate**.
- 7) Select the algorithm under **Type of Signature Algorithm (sha256RSA, sha512RSA)**.
- 8) Select the public key under **Public Key Length**.
- 9) Enter the start and end of the validity period in the relevant fields.
- 10) Then complete the fields **Subject Name** or **Subject Alternative Name**.
- 11) Enter the **CRL Distribution Point**.
- 12) Click on **Apply** followed by **OK**.

## 19.4.2 How to Generate Self-Signed Certificates

### *Prerequisites*

- You are logged into the WBM with the **Expert** profile.

### *Step by Step*

- 1) In the navigation bar, click on **Expert Mode**.
- 2) In the navigation tree, click **Telephony > Security**.
- 3) Navigate in the menu tree down to **SSL > Certificate Generation**.
- 4) Click on the **Generate Self-Signed Certificate** tab in the **Certificate Generation** window.
- 5) In the field **Certificate Name**, assign a name for the generated certificate.
- 6) Enter a serial number also in the field **Serial Number of Certificate**.
- 7) Select the algorithm under **Type of Signature Algorithm**.
- 8) Select the public key under **Public Key Length**.
- 9) Enter the start and end of the validity period in the relevant fields.
- 10) Then complete the fields **Subject Name** or **Subject Alternative Name**.
- 11) Enter the **CRL Distribution Point**.
- 12) Click on **Apply** followed by **OK**.

## 19.4.3 How to Generate Certificate Signing Requests (CSR)

### *Prerequisites*

- You are logged into the WBM with the **Expert** profile.

### *Step by Step*

- 1) In the navigation bar, click on **Expert Mode**.
- 2) In the navigation tree, click **Telephony > Security**.
- 3) Navigate in the menu tree down to **SSL > Certificate Management > Server Certificates**.
- 4) Enter the name of the Certificate Signing Request on the **Generate Certificate Signing Request (CSR)** tab.
- 5) Enter the **Type of Signature Algorithm**.
- 6) Enter the **Public Key Length**.
- 7) Enter the details for the **Subject Name** and for an **Alternative Subject Name**.
- 8) Click on **Apply** followed by **OK**.

## 19.4.4 How to Import Server Certificates (PKCS#12)

### *Prerequisites*

- You are logged into the WBM with the **Expert** profile.

### *Step by Step*

- 1) In the navigation bar, click on **Expert Mode**.
- 2) In the navigation tree, click **Telephony > Security**.
- 3) Navigate in the menu tree down to **SSL > Certificate Management > Server Certificates**.
- 4) Click on the **Import Server Certificate (PKCS#12)** tab in the **Server Certificates** window.

---

**INFO:** If other format is selected, more than one SAN entries is possible to be configured.

---

- 5) Enter the **Certificate Name**.
- 6) Enter the **Passphrase for decryption**.
- 7) Under **File with Certificate**, enter the desired certificate file by using the **Browse** button.
- 8) Click on **Apply** followed by **OK**.

## 19.4.5 How to Display Certificates

### *Prerequisites*

- You are logged into the WBM with the **Expert** profile.

### *Step by Step*

- 1) In the navigation bar, click on **Expert Mode**.
- 2) In the navigation tree, click **Telephony > Security**.
- 3) Navigate in the menu tree down to **SSL > Certificate Management > Server Certificates**.
- 4) Click on the required certificate. The **Server Certificates** window appears.
- 5) Click on the **View Certificate** tab to view the current certificate.

## 19.4.6 How to Delete Certificates

### *Prerequisites*

- You are logged into the WBM with the **Expert** profile.

### *Step by Step*

- 1) In the navigation bar, click on **Expert Mode**.
- 2) In the navigation tree, click **Telephony > Security**.
- 3) Navigate in the menu tree down to **SSL > Certificate Management > Server Certificates**.
- 4) Click on the required certificate. The **Server Certificates** window appears.
- 5) Click on the **Delete Certificate** tab. The name of the certificate currently valid appears with a warning that you are about to delete it.
- 6) Click on **Delete** if you are sure you want to delete the certificate.

## 19.4.7 How to Export Certificates (X.509)

### *Prerequisites*

- You are logged into the WBM with the **Expert** profile.

### *Step by Step*

- 1) In the navigation bar, click on **Expert Mode**.
- 2) In the navigation tree, click **Telephony > Security**.
- 3) Navigate in the menu tree down to **SSL > Certificate Management > Server Certificates**.
- 4) Click on the required certificate. The **Server Certificates** window appears.
- 5) Click on the **Export Certificate (X.509)** tab. You can open or save the certificate.

## 19.4.8 How to Import Updated Certificates (X.509)

### *Prerequisites*

- You are logged into the WBM with the **Expert** profile.

### *Step by Step*

- 1) In the navigation bar, click on **Expert Mode**.
- 2) In the navigation tree, click **Telephony > Security**.

- 3) Navigate in the menu tree down to **SSL > Certificate Management > Server Certificates**.
- 4) Click on the required certificate. The **Server Certificates** window appears.
- 5) Click on the **Import Updated Certificate [X.509]** tab. The name of the certificate currently valid appears.
- 6) Enter the required certificate in the **File with Certificate** field or select **Browse**.
- 7) Complete your input with **Fingerprint of**.

## 19.4.9 How to Activate Certificates

With this function, you specify the certificate to be use for web-based administration.

### *Prerequisites*

- You are logged into the WBM with the **Expert** profile.

### *Step by Step*

- 1) In the navigation bar, click on **Expert Mode**.
- 2) In the navigation tree, click **Telephony > Security**.
- 3) Navigate in the menu tree down to **SSL > Certificate Management > Server Certificates**.
- 4) Click on the required certificate.
- 5) Click on the **Activate Certificate** tab. A warning appears that this action will interrupt all ongoing HTTP connections.
- 6) Select the desired system (OpenScape Business, UC Booster Server, UC Booster Card) for which you want to enable the certificate in the **System** drop-down list.

---

**INFO:** To work properly, the IP address of the system must be entered in the **Common Name** field in every certificate. Make sure that you enable the correct certificate for the selected system.

---

- 7) Click on **Activate Now**.

---

**NOTICE:** The imported Server Certificate must be issued directly from a Root CA. Intermediate CAs must not be used.

---

## 19.5 Web Security

The web access filter can be found under Web Security. It allows you to manage client permissions as well as the admin log which keeps track of any access or change to the communication system.

### 19.5.1 Connections to the Web Server

The connections of the clients (e.g., myPortal to go) to the internal web server of the communication system can be either encrypted (HTTPS) or unencrypted (HTTP).

---

**NOTICE:** Unencrypted connections to the web server may allow unauthorized access to sensitive data! For security reasons, it is strongly recommended that only an encrypted connection (HTTPS) be used when working with myPortal to go (Web Edition) over the Internet.

Only an encrypted connection to the web server is available for myPortal to go (App Edition).

myPortal for OpenStage (XML), the unencrypted connection (HTTP) must be first unlocked.

---

#### 19.5.1.1 How to Configure Connections to the Web Server (UC Suite)

##### *Prerequisites*

- You are logged into the WBM with the **Expert** profile.

##### *Step by Step*

- 1) In the navigation bar, click on **Expert Mode**.
- 2) In the navigation tree, click **Telephony > Security**.
- 3) Navigate in the menu tree to **Web Access**.
- 4) Configure the connections to the web server:
  - If you want to enable encrypted connections, select the check box **HTTPS**.
  - If you want to enable unencrypted connections, select the check box **HTTP**.
- 5) If appropriate, enable **Save login data to device** if you want to allow this function. This causes the login credentials in the web browser of the mobile phone to be saved using cookies.
- 6) Click on **Save**.

## 19.5.1.2 How to Configure Connections to the Web Server (UC Smart)

### *Prerequisites*

- You are logged into the WBM with the **Expert** profile.

### *Step by Step*

- 1) In the navigation bar, click on **Expert Mode**.
- 2) In the navigation tree, click on **Applications > UC Smart > Basic Settings**.
- 3) Make sure that UC Smart is **Active**.
- 4) Configure the connections to the web server:
  - If you want to enable encrypted connections, select the check box **HTTPS**.
  - If you want to enable unencrypted connections, select the check box **HTTP**.
- 5) Click on **Apply**, followed by **OK**.

## 19.5.2 Admin Log (also called Admin Protocol)

The Admin log enables you to track what changes were made to the communication system and by whom and when.

### 19.5.2.1 How to Load the Admin Log

#### *Prerequisites*

- You are logged into the WBM with the **Expert** profile.

#### *Step by Step*

- 1) In the navigation bar, click on **Expert Mode**.
- 2) Click **Maintenance** in the navigation tree.
- 3) Navigate in the menu tree to **Admin Log > Admin Log Data**.
- 4) The message "The admin log will be transferred from the system" appears in the **Admin Log Data** window. Please confirm".
- 5) Click on **Load**.

## 19.5.2.2 How to Change the Admin Log Language

### *Prerequisites*

- You are logged into the WBM with the **Expert** profile.

### *Step by Step*

- 1) In the navigation bar, click on **Expert Mode**.
- 2) In the navigation tree, click on **Telephony > Service**.
- 3) Navigate in the menu tree to **Admin Log > Configuration**.
- 4) Set the desired language in the **Edit Configuration** window under **Admin Log Language**.
- 5) Click on **Apply**.

## 19.6 SQL Security

OpenScape Business stores system configuration data, call data records, user account credentials, UC data etc. in an internal SQL database. Access to the database is protected by login credentials.

Up to SW version V2R2 the used login credentials are protected by a password, which could not be changed by an OpenScape Business administrator. From V2R2 on the password can be changed. The password is machine generated and is not shown to the administrator. For compatibility within multinode scenarios running old SW versions, it is possible to change back a modified password to the "old" value. The SQL access password configuration can be found under SQL Security. The SQL access password configuration can be used both in network and single node environments. The handling for specific single node or multinode scenarios is described with the subsequent chapters.

### 19.6.1 Single node

#### **SW Upgrade from V2R1 or older**

After a SW upgrade from V2R1 the OLD SQL database password is active. The SQL password has to be changed within the new software version by the system administrator using the Administration Portal (WBM).

#### **Setup of new system**

When the date is set up in the system for the first time, a new SQL password will be generated. Only the first time the date and time is set, is when the SQL password is changed automatically.



### Setup of a reloaded "single node" system

After each system reload the OLD SQL database password is active within the system. The SQL password has to be changed within the new software version by the system administrator using the Administration Portal (WBM).

## 19.6.2 Multinode

The single node system is configured and integrated in the network in the known manner. After system setup the new slave node synchronizes its SQL password with the master node. No action is required to adapt the SQL password within the slave node.

### Reload of a V2R2 or higher node within V2R2 or higher Network

After a reload of a network node within the network, the node has to re-configured and integrated again into the network.

### Reload of the Master Node

In case of a master node the SQL password has to be changed by the system administrator using the Administration Portal (WBM). All slave nodes synchronize their SQL password with the new one within the master node. No action is required to change the SQL password within the slave nodes.

### Reload of the Slave Node

In case of a slave node no action is required as the slave node synchronizes its SQL password with the master node.

### New V2R2 or higher slave node within V2R1 Network (not recommended scenario)

The single node system is configured and integrated in the network in the known manner. After system setup the new slave node detects that the master node uses the old SQL password and uses the old SQL password as well. No further action is required to adapt the SQL password within the slave node.

---

**INFO:** It is strictly recommended to upgrade the whole network to the latest software version.

---

### New V2R2 or higher master node within V2R1 Network (not recommended scenario)

The master node system is configured and integrated in the network in the known manner. After system setup the new master node uses the old SQL password. The system administrator may not change the old password, as the V2R1 slaves are not able to synchronize with a new SQL password in the master node. In this case the node would not work together within the network. In case that system administrator has change the SQL password by hazard he has to switch back to the "default" password within the master node configuration.

---

**INFO:** It is strictly recommended to upgrade the whole network to the latest software version.

---

## 19.6.3 How to Configure Passwords to the SQL Database

### *Prerequisites*

- You are logged into the WBM with the **Expert**.

### *Step by Step*

- 1) In the navigation bar, click on **Expert Mode**.
- 2) In the navigation tree, click **Telephony Server > Security**.
- 3) Navigate in the menu tree to **SQL Security**.
- 4) Configure the passwords to the SQL database:
  - If you want to generate a new password not known to the user, select the box **Generate new**.
  - If you want the default password to be activated, select the box **Activate default**.

---

**INFO:** In the landing page notification area, the following message will be displayed if the default sql password is used (or a password generated with the old password generation algorithm):

```
'Default SQL password is in use. Please consider  
changing it via Expert mode'
```

The message is a URL link that leads to the SQL Security page in order to change it.

---

## 19.7 SIP Attack Protection

The so-called SIP attacks represent a new form of attacks on communications systems via IP telephony. Such attacks may occur either from the LAN or via the Internet (through badly configured routers). Protection against SIP attacks is provided through password-protected SIP access.

The following rules should be applicable for any SIP subscriber access:

- Active authentication
- A qualified password that
  - is between 8 and 20 characters in length
  - includes one or more uppercase letters (A to Z)

- includes one or more lowercase letters (A to Z)
- includes one or more digits (0 to 9),
- includes one or more special characters (e.g.: %),
- does not have more than 3 repeated characters
- Definition of a SIP station ID that differs from the station number.

When a new SIP station is set up, authentication is activated by default, and a random password is generated. Since this random password is not known, it must be changed by the administrator.

The relevant settings in the communication system are made using the "Central Telephony" wizard or Manager E.

During system startup, the password list is checked, and a n entry is made in the EventLog (Event Viewer) if a SIP station is configured without a password.

---

**INFO:** If the communication system is used as an Internet router, port 5060 must be closed (default setting). For Internet telephony via an ITSP, the communication system opens the relevant ports and keeps them open.

Port 5060 must likewise be closed If an external router or firewall is being used. The communication system is responsible for opening this port (if required).

---

## 20 Networking OpenScape Business

OpenScape Business communication systems can be networked with one another and additionally with the communication systems OpenScape 4000 (HiPath 4000) and OpenScape Voice as well. In a homogeneous OpenScape Business network, subscribers can now use features such as the presence status, voicemail, conferencing and much more in exactly the same way as was originally possible with only a single OpenScape Business communication system.

### Possible Networks:

- Pure voice network of OpenScape Business X
- OpenScape Business X and S OpenScape Business networking (optionally with UC Suite or UC Smart).
- OpenScape Business X with OpenScape 4000 (UC functionality in OpenScape Business only under certain conditions)
- OpenScape Business X with OpenScape Voice (without UC functionality in OpenScape Business)
- Connecting External Auxiliary Equipment to OpenScape Business via SIP Interconnection.
- Networking via ISDN
- OpenScape Business internetwork with central ITSP trunk connection

The communication systems are prepared for networking with the **Networking Configuration** wizard. In this wizard, it must be specified whether a master or slave node is involved. In addition, 16 lines are automatically assigned to route 16 (networking).

All networks that use unified communications features (such as UC Smart or UC Suite, for example) must be based on a closed numbering plan. Networks without unified communications features can be based on an open or closed numbering plan. In order to respond flexibly to future extension requests from customers, it is recommended to always use closed numbering for any newly created internetwork.

---

**INFO:** Configuring an IP network is a complex task and should only be performed by experienced service technicians.

---

It is not possible to set up a pure OpenScape Business X1 internetwork, since an X1 system cannot be a master system, and there always needs to be a master system in the internetwork.

A network of OpenScape Business with the following systems is not supported:

- HiPath 3000 SIP-Q; only TDM networking based on S0/S2M with CorNet NQ is supported; see [Networking via ISDN](#),
- HiPath 5000 RSM
- OpenScape Office MX
- OpenScape Office LX

The migration from a HiPath 3000 (including HiPath 5000 RSM) to OpenScape Business is described in the section on [Migration](#).

## 20.1 Network Plan

Before configuring an internetwork, a network plan should first be created after consulting with the customer.

The network plan should include the following data:

- Node ID (node number) and the associated IP addresses
- Dial plan

### 20.1.1 Homogeneous and Heterogeneous Networks

In general, a distinction is made in networking between homogeneous (where all components belong to a single systems family) and heterogeneous networks (with different systems).

#### Homogeneous (Native) Network

A homogeneous (native) network consists of components of the OpenScape Business systems family.

#### Heterogeneous (Hybrid) Network

A heterogeneous (hybrid) network consists of components of the OpenScape Business systems family and an OpenScape 4000 or an OpenScape Voice, for example.

#### Overview of all OpenScape Business Nodes in the Network

All OpenScape Business nodes in an internetwork can be displayed via the **Network** entry in the navigation bar of the WBM. In addition, all the OpenScape Business stations of the internetwork can be displayed sorted by node.

The following information can be displayed:

- **Node ID:** Node ID
- **M / S:** Identification to indicate whether the node is a Master or Slave
- **Network name:** name of the node
- **Type:** type of the node (**OSBiz X:** hardware model, **OSBiz S:** softswitch)
- **OSBiz X / OSBiz S:** IP address of the node, clickable (opens the WBM of the node)
- **Application Server:** IP address of the UC server (UC Booster Card or UC Booster Server)
- **Registration status:** status of the registration
- **Active:** Displays whether the node is active or not

## 20.1.1.1 How to Display the Overview of all OpenScape Business Nodes

### Prerequisites

- Multiple OpenScape Business communication systems are networked with one another.

### Step by Step

- 1) In the navigation bar, click on **Networking**.
- 2) Click on **Domain View** in the navigation tree. All OpenScape Business nodes in the internetwork are listed.

## 20.1.2 Single and Multi-Gateway

In homogeneous OpenScape Business networks, a distinction is made between a single network and multi-gateway network, depending on whether only a single gateway or multiple gateways are used.

### Single Gateway

In the case of a single-gateway network, calls from and to the server are routed via a single gateway. All IP stations that are registered at the server use this single gateway.

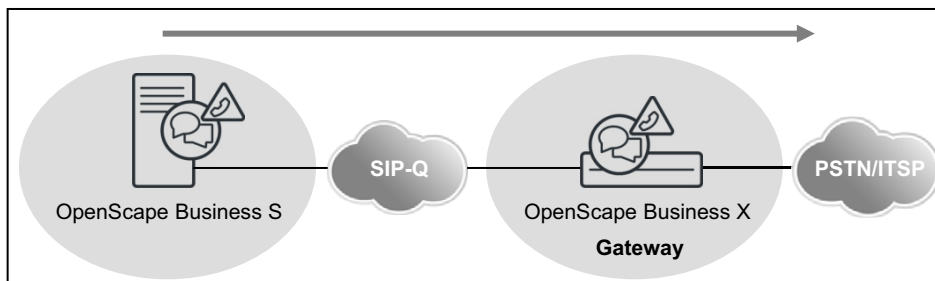

- Supported if there are one or more OpenScape Business S systems in the network.
- The IP stations are connected to different communication systems.
- OpenScape Business X is used as a gateway.

### Multi-Gateway

In the case of a multi-gateway network, calls are routed via several different OpenScape Business gateways.

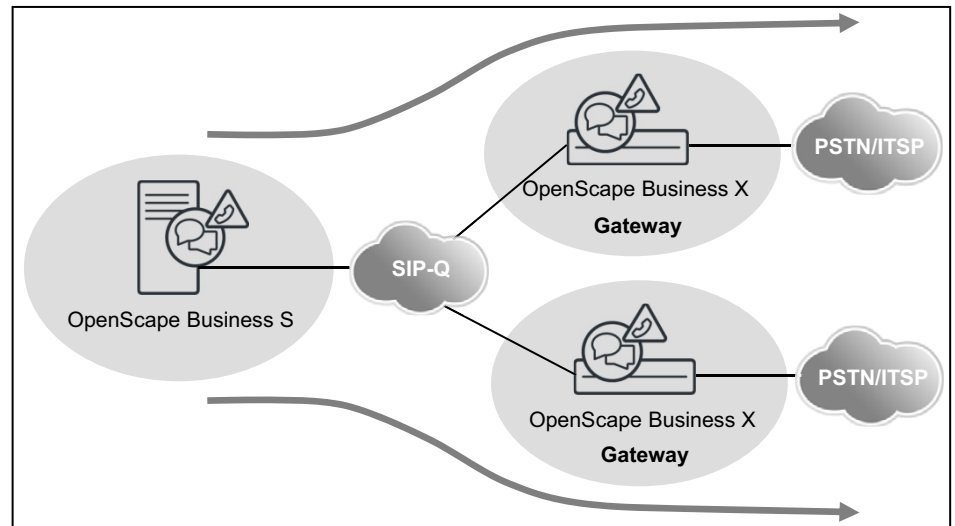

- There is only one PSTN Provider and one CO station number per gateway.
- The stations of the different locations are registered at a central system (OpenScape Business S).
- Every station of the OpenScape Business S is assigned a specific gateway (OpenScape Business X).
- There must only be a single OpenScape Business S in the network.
- OpenScape Business and OpenScape Business S are in the same time zone and in the same country (same country code).
- There is only one CO access code netwide.
- ISDN and analog stations, for example, can be locally set up on the gateways.

## 20.2 Network-wide Features

Network-wide voice features are essentially determined by the SIP-Q networking protocol. Network-wide UC features are determined by the networking of the UC solution (UC Suite or UC Smart) and their UC clients.

### 20.2.1 Network-wide Features of the UC Solutions

The following table provides you with an overview of the network-wide features of both the UC solutions, UC Smart and UC Suite.

UC interworking using both OpenScape 4000 and OpenScape Voice is not possible. In an OpenScape Business internetwork, either UC Smart or UC Suite should be used. Mixed UC solutions are not supported.

Network-wide UC features	UC Smart		UC Suite	
	myPortal Smart	myPortal to go	myPortal for Desktop / Outlook	myPortal to go
Network-wide visibility of the Presence status (presence management)	x	x	x	x
Change of own presence status via the client	x	x	x	x
Change of own presence status via the TUI	x	x	x	x
Status-based call forwarding	x	x	x	Via destinations defined in myPortal
Network-wide status display in Favorites	x	x	x	x
Network-wide status display in directories	x	x	x	x
Network-wide status display in the Journal	-	-	x	-
Enable CallMe service	-	-	x	x
Calendar integration (Outlook)	-	-	x	-
Calendar integration (iCal) (only with myPortal for Desktop)	-	-	x	-
Network-wide display of the call status (free, busy, ringing state)	x	x	x	x
Creation of network-wide groups	x	x	x	-
Compact display of favorites	x	-	x	-
Personal directory	Local	Local	Local	Local
Internal directory	Local	Local	Local	Local
External directory	-	-	x	x
Searching in directories on a network-wide basis	x	x	x	x
Access to speed-dial destinations defined in the system (SSD)	Local	Local	-	Local
Import/Manage personal contacts (CSV/XML)	x	-	x	-
Access to Outlook Contacts	x	-	x	-



Network-wide UC features	UC Smart		UC Suite	
	myPortal Smart	myPortal to go	myPortal for Desktop / Outlook	myPortal to go
Import personal contacts (Mac OS) (myPortal for Desktop)	-	-	X	-
Integration of external directory server via LDAP	-	-	X	-
All calls	X	X	X	X
Open calls	X	X	X	-
Missed calls	X	X	X	X
Answered calls	X	X	X	X
Scheduled calls	-	-	X	-
Fax journal	-	-	X	-
Manual dialing	X	X	X	X
Desktop dialer (click to call)	X	-	X	-
Forwarding	X	X	X	X
Place call on hold	X	X	X	X
Record calls (voice recording)	-	-	X	-
Send e-mail	X	X	X	X
Send SMS	-	X	-	X
Popups	X	-	X	-
AdHoc conference	X	X	X	X
Scheduled conferences	-	-	X	-
Permanent and open conferences (drag & drop conference)	X	-	X	-
Web Collaboration Integration	X	-	X	-
Voicemail box (visual voicemail)	X	X	X	X
Listen to voicemail via telephone	X	X	X	X
Listen to voicemail via PC sound card	-	-	X	-
How to Send a Voice Message as an E-mail	X	X	X	-
Fax (for Windows operating systems)	-	-	X	-
Instant messaging (chat) network-wide	X	-	X	-

## 20.2.2 Network-wide Voice Features

For networking via the SIP-Q protocol, the following voice features are supported for OpenScape Business and other communication systems.

Feature	SIP-Q (IP Network)
Basic call	Yes
Callback on busy	Yes
Callback on RNA	Yes
Override	Yes
Call waiting	Yes
Second call	Yes
Calling Line Identification Presentation (CLIP)	Yes
Calling Line Identification Restriction (CLIR)	Yes
Connected Line ID Presentation (COLP)	Yes
Connected Line ID Restriction (COLR)	Yes
Calling / Connected Name Identification Presentation (CNIP)	Yes
Calling / Connected Name Identification Restriction (CNIR)	Yes
Do Not Disturb	Yes
Call forwarding	Yes
Call Forwarding on Busy	Yes
Call Forwarding on RNA	Yes
Call Deflection	Yes
Advice of Charge at Call Setup	no
Advice of Charge during Call	Yes
Advice of Charge at the end of the call	Yes
Path optimization	Yes
Rerouting	no
Message Waiting Indication / Info	Yes
Trace call	Yes
Hold	Yes
Toggle/Connect	Yes
Transfer	Yes
Conferencing	Yes
Automatic Recall	Yes
Calling for Help	Yes

Feature	SIP-Q (IP Network)
Intercept	Yes
Private Numbering Plan (PNP)	no
Call pickup	no
Hunt Group	Yes
SPE (except for conferencing and applications)	Yes

## 20.3 Licensing an Internetwork

For a networked communication system, central licensing can be selected.

All licenses of the individual systems are combined into a network-wide license at the license server. In the internetwork, the licenses can be assigned freely to the individual nodes using the WBM.

For more information, see [Licensing Multiple Communication Systems \(Internetwork\)](#).

## 20.4 Networking Requirements

To ensure the quality of the voice transmission, the IP networks being used and the communication system must meet certain requirements. The voice quality and voice communication reliability always depend on the network technology in use.

### Network Parameters, LAN and WAN Requirements

Parameters	Minimum requirement	Notes
Delay (one way)	50 ms	Higher values degrade the voice quality.
Round Trip Delay	100 ms	Higher values degrade the voice quality.
Jitter	20 ms	Higher values degrade the voice quality.
Packet Loss	3%	For fax or modem transmissions using G.711, the packet loss should not exceed 0.05% (in the event that no T.38 is possible).
Consecutive Packet Loss	3 with G.711	Higher values degrade the voice quality.

### Recommendation for Calculating Bandwidth

- A bandwidth of at least 256 kbps (in both the sending and receiving direction) is required on the internetwork.

- The bandwidth calculation should be based on a maximum of 50% for the voice portion with respect to the total bandwidth. In other words, in the case of a 1 Mbit WAN, for example, a maximum of 500 kbps should be calculated for voice. With the G.711 codec, for example, that would be a maximum of 5 IP trunks.
- Regardless thereof, the network properties with respect to QoS, delay, packet loss, etc., must also be taken into account.

## 20.4.1 LAN Networking Requirements

To ensure the quality of the voice and data transmissions, the IP networks being used and the communication system must meet certain requirements for the LAN.

### LAN requirements

The data network must be of the Ethernet type:

- The recommended cable is at least a Cat.5 cable (screened/unscreened multi-element cables characterized for up to 100 MHz for horizontal and building backbone cables as per EN 50288).
- Support for QoS: IEEE. 802.1p, DiffServ (RFC 2474).
- All active LAN ports must support 100 / 1000 MBit/sec. and full duplex communications.

Every communication system must be connected via a switch or a dedicated port of a router. Hubs and repeaters are not supported.

### Payload Connections with RTP (Real-time Transport Protocol) in a LAN Environment

The required bandwidth for voice transmissions in an IP network can be calculated with the help of the following table:

Codec type	Packet parameters	Sample Rate (ms)	Payload (bytes)	Ethernet packet length (bytes)	Payload packet (overhead in percent)	Ethernet load (incl. header) (kbps)
G.711	20	20	160	230	44%	92
G.711	30	30	240	310	29%	82.7
G.711	40	40	320	390	22%	78
G.711	60	60	480	550	15%	73.3
G.729A	1	20	20	90	350%	36
G.729A	2	40	40	110	175%	22
G.729A	3	60	60	130	117%	17.3
RTCP		5000		280		0.4

The load in the LAN applies to both the sending and receiving direction.

The calculation includes VLAN tagging in accordance IEEE 802 1q. Without VLAN tagging, the packet length is shorter by 4 bytes.

The overhead is calculated as follows:

Protocol	Bytes
RTP Header	12
UDP Header	8
IP Header	20
802.1Q VLAN Tagging	4
MAC (incl. Preamble, FCS)	26
Total	70

Payload transport in a T.38 LAN environment:

	Sample Rate (ms)	Payload (bytes)	Ethernet packet length (bytes)	Payload packet (overhead in percent)	Ethernet load (incl. header) (kbps)
T.38	30	169	227	34%	60.5

Payload Connections with SRTP (Real-time Transport Protocol) in a LAN Environment:

Codec type	Sample Rate (ms)	Payload (bytes)	Ethernet packet length (bytes)	SRTP Ethernet packet length (kbps)	RTP Ethernet packet length (kbps)	Additional bandwidth for SRTP (%)
G.711	20	160	244	97.6	92	6.1
G.711	30	240	324	86.4	82.4	4.5
G.711	40	320	404	80.8	78	3.6
G.711	60	480	564	75.2	73.3	2.5
G.729A	20	20	104	41.6	36	15.6
G.729A	40	40	124	24.8	22	12.7
G.729A	60	60	144	19.2	17.3	10.8

## 20.4.2 Dial Plan in the Network

The dial plan is an important prerequisite for networking. The complexity of the internetwork configuration depends on the dial plan. OpenScape Business generally supports open and closed numbering in an internetwork. It should be noted, however, that the full scope of UC features can only be used only with closed numbering.

### Closed numbering

In the case of closed numbering, a station in the internetwork is uniquely identified by the station number. Each station in the internetwork can reach another station by directly dialing its station number.

The advantage of closed numbering is that you do not have to dial a node number to reach another station in another networked communication system.

**Table:** Examples of closed numbering

	Node 1	Node 2	Node 3	Node 4
Phone Numbers	100	200	300	400
	101	201	301	401
	102	202	302	402
	103	203	303	403
	104	204	304	404

### Open numbering

In open numbering, a station is uniquely identified by the node number and the station number. Users of different communication systems (nodes) in the internetwork can thus have the same station number.

With open numbering, the station's node number must always be dialed in addition to the phone number. Phone number ranges can be used more than once for this, and multiple phone numbers can be used.

The following UC features are not supported with open numbering:

- UC Smart
- UC Suite
- network-wide CSP (CSTA Service Provider)
- DSS server
- CMD (CSTA Message Dispatcher)

**Table:** Examples of Open Numbering

	Node 1	Node 2	Node 3	Node 4
Node number (PABX number)	95	96	97	98
Phone Numbers	100	100	100	100
	101	101	101	101
	102	102	102	102
	103	103	103	103
	104	104	104	104

## 20.4.2.1 Dialing Public Phone Numbers in the Network

Regardless of whether a closed or open numbering system is being used, it makes sense to dial both node and network-internal destinations using public phone numbers (e.g., as a UC client that dials contacts in the fully-qualified format from directories).

## 20.5 Path Optimization (Path Replacement)

Path optimization (also called path replacement) helps to avoid the dual seizure of IP trunks for networked communication systems.

When multiple OpenScape Business systems are networked, the following problem could occur, for example: First, let us assume that subscriber A calls subscriber B who, in turn, has forwarded all calls to subscriber C. Subscribers A and C are in the same network node, but subscriber B is on a different network node. Consequently, the call with call forwarding initially seizes two trunks between the two network nodes. To avoid this dual seizure, path optimization must be enabled.

---

**INFO:** The system flag for the path optimization must be enabled for all networked OpenScape Business systems.

---

The path optimization is performed:

- Within the OpenScape Business network segment
- After the connection setup (not in the ringing phase!)
- After transfer scenarios
- After call forwarding and CFNA (call forwarding-no answer)

The path optimization is not performed:

- When a ringing group or group call is involved
- For conferences
- If some other feature is enabled when executing the path optimization, the optimization is aborted.
- For inhomogeneous networking, the external systems are configured via the SIP interconnection. In this case, regardless of the configuration of the flag, no path replacement is possible (e.g., OpenScape 4000, OpenScape Voice, external SIP servers).

### 20.5.1 How to Enable or Disable Path Optimization (Path Replacement)

#### *Prerequisites*

- You are logged into the WBM with the **Expert** profile.

#### *Step by Step*

- 1) In the navigation bar, click on **Expert Mode**.
- 2) Click **Telephony > Basic Settings** in the navigation tree.
- 3) In the menu tree, click on **System > System Flags**.
- 4) Select one of the following options:

- If you want to allow a call pickup for recalls, enable the **Path optimization** check box.
  - If you do not want to allow a call pickup for recalls, clear the **Path optimization** check box.
- 5) Click on **Apply** followed by **OK**.

## 20.6 Networking Scenarios

There are several scenarios how OpenScape Business systems can be networked with one another and with other communication systems.

- Networking Multiple OpenScape Business X Systems
- Networking OpenScape Business X and OpenScape Business S (Single Gateway)
- Networking OpenScape Business X and OpenScape Business S (Multi-Gateway)
- Networking of OpenScape Business S in a Hosting Environment
- Networking OpenScape Business X and OpenScape Voice
- Networking OpenScape Business X and OpenScape Voice
- Connecting External Auxiliary Equipment to OpenScape Business via SIP Interconnection
- Open Numbering in OpenScape Business X Networks
- Networking via ISDN
- OpenScape Business internetwork with central ITSP trunk connection

Call charge details can only be retrieved per network node, but not across nodes.

### 20.6.1 Dependencies and Restrictions

It is important to note some dependencies and constraints on the possible networking scenarios.

#### Dependencies and Restrictions

- Every system in the internetwork is assigned its own time zone. Consequently, all stations in a system have the same time zone.
- OpenScape Business S multi-gateway networks have only been released within a country (same time zone, same CO access code).
- As a general rule, all OpenScape Business internetworks are configured using wizards. OpenScape Voice and OpenScape 4000 in the internetwork are configured per node in Expert mode.
- The Presence Manager (DSS server functionality = network-wide display of busy states at DSS keys + call pickup) is available in OpenScape Business networks.



- SIP-Q trunks with route 16 (last route) are used to configure homogeneous OpenScape Business communication systems via the **Networking Configuration** wizard. External SIP trunks (SIP interconnections) are used for networking OpenScape 4000, OpenScape Voice or other communication systems; the configuration is performed in Expert mode.
- If the system is configured as a slave or master using the **Networking Configuration** wizard, a check is performed to determine whether lines are assigned to "Networking" route. If not, 16 lines are automatically assigned to the "Networking" route. If the system is removed from the internetwork, these assignments are retained.
- In each node, only ONE voicemail system can be used. As a general rule, different voicemail systems are allowed in an OpenScape Business internetwork:
  - If the UC Suite is used, any other voicemail systems present in the internetwork must be disabled by the administrator.
  - A HiPath 3000 internetwork with different voicemail systems can be migrated 1:1 to OpenScape Business.
- For technical reasons, OpenScape Business X1 systems can not be set up as masters. Since a master system is required in each OpenScape Business network, at least one system must be larger than X1.

---

**INFO:** The relevant sales limits may differ from these details (and the following details in the individual scenarios). Please read the notes in the Sales Information.

---

## 20.6.2 Networking Multiple OpenScape Business X Systems

Up to 32 OpenScape Business X communication systems can be networked with each other.

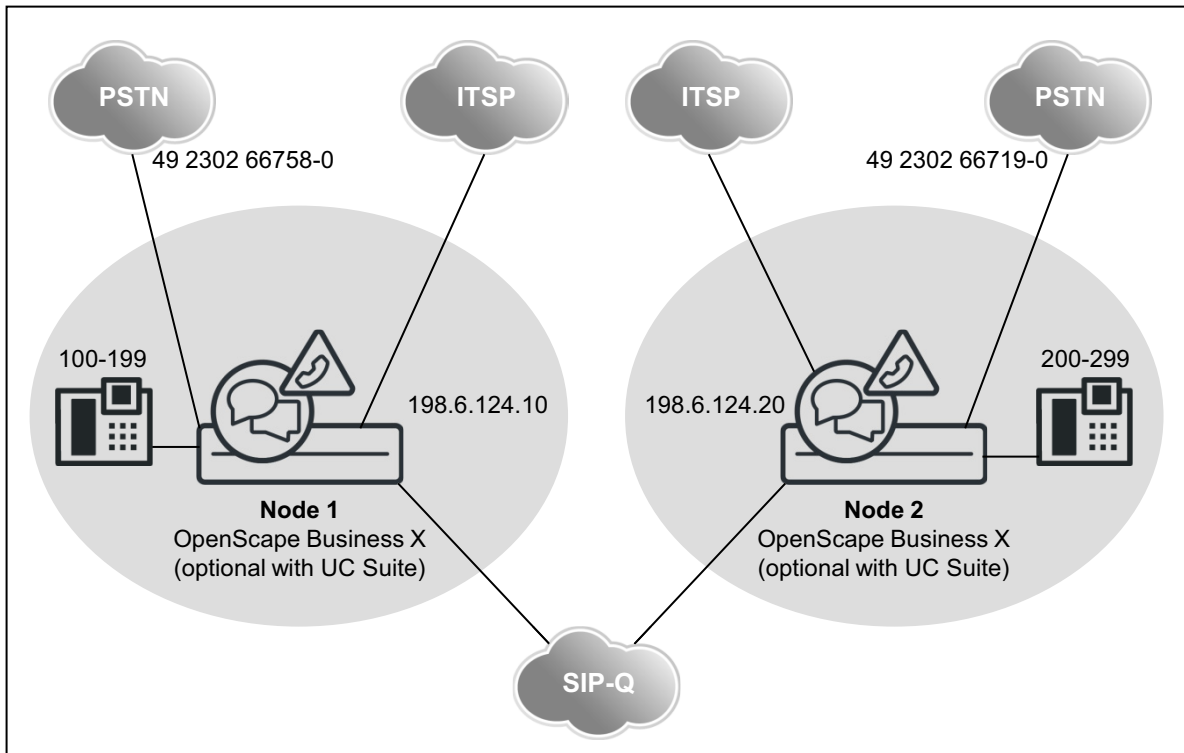

**Network Data**

- With UC solution (UC Smart or UC Suite): Only closed numbering possible
- Without UC solution: Closed or open numbering possible
- Configuration via WBM (wizards) when using closed numbering
- UC Suite functionality based on UC Booster Server or UC Booster Card
- Up to 32 networked systems and 1500 users without UC solution
- Up to 8 networked systems and 1500 users with UC solution

**Network-wide Features**

UC networking	Closed numbering	Open numbering
Maximum number of nodes	8 with UC solution and 32 without UC solution	
Maximum number of stations in a single communication system	Depending on OpenScape Business X	
Maximum number of stations in the network	1500	

UC networking	Closed numbering	Open numbering
UC Booster Card	UC Smart: 51 - 150 stations (0 - 50 stations without UC Booster Card) UC Suite: 0 - 150 stations	Not supported
UC Booster Server	UC Smart: from 150 stations UC Suite: from 150 stations	Not supported

Administration	Closed numbering	Open numbering
WBM	Network-wide administration using wizards	Network-wide administration in Expert mode
Manager E	Network-wide administration for special tasks	Network-wide administration for special tasks
UC Suite Administration (for UC Booster Server and UC Booster Card)	Network-wide administration using wizards	Not supported
Mass data import via CSV files (call numbers, DID numbers, names)	Separately for each node in the internetwork	

Licensing	Closed numbering	Open numbering
Licensing structure	A networking license is required for each node	

### Configuration

This configuration (with closed numbering and UC Suite) shows the steps required to set up networking with the help of an example.

Prerequisites:

- A network plan is available. The network plan was used to ensure that every internal call number in the internetwork is only used once for closed numbering. Different station number lengths are allowed. Only DID station numbers may occur more than once (e.g., the CO station numbers 49 2302 66758 100 and 49 2302 66719 100 have the same DID No. 100).

---

**INFO:** The station numbers may need to be adapted. An open numbering scheme is not implemented!

---

- The IP network has been configured, and all nodes can be mutually pinged successfully
- All nodes have been upgraded to the same software version

Call forwarding across nodes: For incoming calls over IP trunks, which have already been forwarded, no further forwardings to the voicemail box are executed. This is because no unique assignment to the voicemail box can otherwise be made

If cross-node deputy rules (referral extensions) are required, this must be set up via the profiles of the OpenScope Business stations or ringing groups. The corresponding cross-node calls are not signaled as forwarded in this case, but as

DSS (direct station selection) calls. Call forwardings of the deputy are therefore forwarded to the voicemail box

**Table:** Setting up the Location Data for Node 1

Node 1		
G.-Location Country		49
G.-Location Local Network		2302
G.-Location System		66758
International Prefix		00
National Prefix		0
<b>Routes</b>		
ISDN	Trunk code	0
Networking	2nd trunk code	0
<b>Routing parameters</b>		
Route	No. and type, outgoing	RNR type
Networking	Unknown	Int/DID
ISDN	(No change in entry)	DID

The station numbers of all stations outside node 1 are automatically entered in the routing tables. This includes the internal station numbers as well as the DID station numbers, which differ from the respective internal station numbers.

**Table:** Overview of Entries in the LCR for Node 1

Dial Plan		Routing table			Dial Rule		
Name	Dialed digits	Route	Dedicated Gateway	Gateway ID	Dial Rule	Procedure	Type
Node 2 Internat	0C004923026 6719-Z	Networking	Mandatory	2	D492302667 19E3A	Corp. Network	International
Node 2 NAT	0C023026671 9-Z						
Node 2 Stn.	0C66719-Z						
CO	0CZ	ISDN	No		A	Main network supplier	Unknown
Various	-Z	Networking	No		A	Corp. Network	Unknown

**Table:** Setting up the Location Data for Node 2

Node 2	
G.-Location Country	49
G.-Location Local Network	2302
G.-Location System	66719
International Prefix	00

Node 2		
National Prefix		0
<b>Routes</b>		
ISDN	Trunk code	0
Networking	2nd trunk code	0
<b>Routing parameters</b>		
Route	No. and type, outgoing	RNR type
Networking	Unknown	Int/DID
ISDN	(No change in entry)	DID

The station numbers of all stations outside node 2 are automatically entered in the routing tables. This includes the internal station numbers as well as the DID station numbers, which differ from the respective internal station numbers.

**Table:** Overview of Entries in the LCR for Node 2

Dial Plan		Routing table			Dial Rule		
Name	Dialed digits	Route	Dedicated Gateway	Gateway ID	Dial Rule	Procedure	Type
Node 1 Internat	0C0049230266758-Z	Networking	Mandatory	1	D49230266758E3A	Corp. Network	International
Node 1 NAT	0C0230266758-Z						
Node 1 Stn.	0C66758-Z						
CO	0CZ	ISDN	No		A	Main network supplier	Unknown
Various	-Z	Networking	No		A	Corp. Network	Unknown

Procedure to Set up Networking:

1. Configure the basic installation for node 1 (master)
2. Configuring Networking for Node 1
3. Configure the basic installation for node 2 (slave)
4. Configuring Networking for Node 2
5. Verify the networking function for the master
6. Check routes and routing parameters (master)
7. Check routes and routing parameters (Trk. Grp. 16) (master)
8. Configure LCR for networking (master)
9. Check routes and routing parameters (Slave)
10. Configure LCR for networking (slave)

## 20.6.2.1 How to Configure the Basic Installation for Node 1 (Master)

For integration in an internetwork, the country code and a node ID must be assigned. The internal station numbers must be uniquely configured throughout the network. The entry of the national and local station numbers is important, since this station number is set in the Trk. Grp. 1 ISDN trunk and used as the location number for normalization.

### Prerequisites

- You are logged on to the WBM with the **Advanced** profile.

### Step by Step

- 1) In the navigation bar, click on **Setup**.
- 2) In the navigation tree, click **Wizards > Basic Installation**.
- 3) Click on **Edit** to start the **Basic Installation** wizard.
- 4) In the **Country Code** field, enter the country code prefix, e.g., 49 for Germany.
- 5) Enter the **Area Code** and **PABX number**.
- 6) Select the **Network Integration** check box.
- 7) In the **Node ID** field for OpenScape Business, enter a node ID that is unique in the internetwork (a "1" for the configuration example).
- 8) Click on **Execute function**. You are taken to the **Central Functions for Stations** window.
- 9) Since all internal station numbers must be unique in a network, the standard station numbers must be deleted. Enable the **Delete all station call numbers** radio button.
- 10) Enable the check box **Delete all station numbers** and click on **OK & Next**. You are taken to the **Change preconfigured call and functional numbers** window.

---

**INFO:** The function codes must be unique in the internetwork.  
Duplicate station numbers are not allowed!

---

- 11) Adapt the preconfigured station numbers to the station numbers in the network and click **OK & Next**. You can optionally adapt the station numbers manually via the wizard or import a CSV file with the appropriately prepared station numbers.
- 12) Now configure the IP clients.
- 13) Edit the settings for a Meet-Me conference. You must enter a code that is unique in the internetwork.
- 14) Now configure the sending of e-mails.
- 15) Click on **Finish**.

## 20.6.2.2 How to Configure Networking for Node 1 (Master)

In the next step, the wizard is used to configure the networking.

### *Prerequisites*

- You are logged on to the WBM with the **Advanced** profile.

### *Step by Step*

- 1) In the navigation bar, click on **Setup**.
- 2) In the navigation tree, click **Wizards > Basic Installation**.
- 3) Click on **Edit** to start the **Networking Configuration** wizard.
- 4) Select the **Network with OSBiz X / S OSBiz S** setting.
- 5) Define the node type (**Master**).
- 6) Under **Node ID**, enter the appropriate node numbers of the associated OpenScape Business systems (in the configuration example, those of the slaves with node ID 2).
- 7) Under **IP Address**, enter the IP addresses of the associated OpenScape Business systems (in the configuration example, those of the slave with node ID 2).
- 8) Under **Name**, enter the appropriate type of the subsystem.
- 9) Enable the **Encryption Required** check box if required.

---

**INFO:** The encryption is based on SPE and does not apply to the applications!

---

---

**NOTICE:** Note that the encryption is not configured by simply enabling the check box. See [Signaling and Payload Encryption \(SPE\)](#).

---

- 10) Click on **Finish**.

## 20.6.2.3 How to Configure the Basic Installation for Node 2 (Slave)

For integration in an internetwork, the country code and a node ID must be assigned. The internal station numbers must be uniquely configured throughout the network. The entry of the national and local station numbers is important, since this station number is set in the Trk. Grp. 1 ISDN trunk and used as the location number for normalization.

### *Prerequisites*

- You are logged on to the WBM with the **Advanced** profile.

### Step by Step

- 1) In the navigation bar, click on **Setup**.
- 2) In the navigation tree, click on **Wizards > Basic Installation**.
- 3) In the **Country Code** field, enter the country code prefix, e.g., 49 for Germany.
- 4) Enter the **Area Code** and **PABX number**.
- 5) Select the **Network Integration** check box.
- 6) In the **Node ID** field for OpenScape Business S, enter a node ID that is unique in the internetwork (a "2" for the configuration example).
- 7) Click on **Execute function**. You are taken to the **Central Functions for Stations** window.
- 8) Since all internal station numbers must be unique in a network, the standard station numbers must be deleted. Enable the **Delete all station call numbers** radio button.
- 9) Enable the check box **Delete all station numbers** and click **OK & Next**. You are taken to the **Change preconfigured call and functional numbers** window.

---

**INFO:** The function codes must be unique in the internetwork.  
Duplicate station numbers are not allowed!

---

- 10) Adapt the preconfigured station numbers to the station numbers in the network and click **OK & Next**. You can optionally adapt the station numbers manually via the wizard or import a CSV file with the appropriately prepared station numbers.
- 11) Now configure the IP clients.
- 12) Edit the settings for a Meet-Me conference. You must enter a code that is unique in the internetwork.
- 13) Now configure the sending of e-mails.
- 14) Click on **Finish**.

## 20.6.2.4 How to Configure Networking for Node 2 (Slave)

In the next step, the wizard is used to configure the networking.

### Prerequisites

- You are logged on to the WBM with the **Advanced** profile.

### Step by Step

- 1) In the navigation bar, click on **Setup**.
- 2) In the navigation tree, click **Wizards > Basic Installation**.



- 3) Click on **Edit** to start the **Networking Configuration** wizard.
- 4) Select the **Network with OSBiz X / S OSBiz S** setting.
- 5) Under **Node type** , select the check box **This system is a SLAVE node**.
- 6) Enter the IP address of the master under **IP address**.

---

**INFO:** Note that this action cannot be undone after clicking **OK & Next!**

---

- 7) The **Registration Status** displays **Status successful** (or a corresponding error message). This completes the wizard.
- 8) Click on **Finish**.

### 20.6.2.5 How to Verify the Networking Function for the Master

You can verify the status of the network in general and also the individual station numbers.

#### *Prerequisites*

- You are logged on to the WBM with the **Advanced** profile.

#### *Step by Step*

- 1) In the navigation bar, click on **Network**.
- 2) The status bar shows the **Synchronization status** for the network. Green means that there are no networking problems; red indicates problems in the network.
- 3) Selecting the **Domain View** tab in the **Network** window shows all available nodes with the **Node ID**, **Name**, **System Type**, **Server Address**, **Registration Status** and **Availability Status**.
- 4) Selecting the **Phone Numbers** tab in the **Network** window opens a window with all the relevant details on the following:
  - Call number**
  - DID**
  - Name**
  - Port Type**
  - Nodes**

### 20.6.2.6 How to Configure Routes and Routing Parameters (ISDN Trunk for the Master)

In the following steps, you will configure the routes for the networking of the master.

### **Prerequisites**

- You are logged into the WBM with the **Expert** profile.

### **Step by Step**

- 1) In the navigation bar, click on **Expert Mode**.
- 2) In the navigation tree, click **Telephony > Trunks/Routing**.
- 3) In the menu tree, click **Route**.
- 4) In the **Change Route** window, enter a name for the CO trunk in the **Route Name** field, e.g., *Route 1*.
- 5) Under **Seizure code**, enter 0.
- 6) Under **Incoming PABX number**, in the **Country code** field, enter the value 49.
- 7) Under **Incoming PABX number**, in the **Local area code** field, enter the value 2302.
- 8) Under **Incoming PABX number**, in the **PABX number** field, enter the value 66758.
- 9) Select the check box **Incoming PABX number** in the **Location number** field.
- 10) Click on **Apply** followed by **OK**.

## **20.6.2.7 How to Configure Routes and Routing Parameters (Trk. Grp. 16) (Master)**

For route 64 (networking), the entry for the 2nd trunk code is mandatory for the master and slave and must be filled in. Route 16 is the default route for networking with OpenScape Business.

### **Prerequisites**

- You are logged into the WBM with the **Expert** profile.

### **Step by Step**

- 1) In the navigation bar, click on **Expert Mode**.
- 2) In the navigation tree, click **Telephony > Trunks/Routing**.
- 3) In the menu tree, click on the last **Route (Route 16)**.
- 4) In the **Change Route** window, enter a name for the network route in the **Route Name** field, e.g., *Networking*.
- 5) Do not enter anything for the **Seizure code**.
- 6) Enter a "0" under **CO code (2nd trunk code)**.
- 7) The default settings for the routing parameters (No. and type, outgoing, Call number type) can be used.
- 8) Click on **Apply** followed by **OK**.

## 20.6.2.8 How to Configure Least Cost Routing (LCR) for the Network (Master)

The default entries in index 32, 33 and 34 in the LCR dial plan must be extended with further entries to enable the dialing of station numbers in "international, national and station" formats for calls to node 2. "International" and "National" are always needed. "Local" is only needed for partner nodes that are in the same local network. These entries are used for dialing from applications (e.g., myPortal for Desktop).

### Prerequisites

- You are logged into the WBM with the **Expert** profile.

### Step by Step

- In the navigation bar, click on **Expert Mode**.
- In the navigation tree, click **Telephony > LCR**.
- Click on **Dial Plan** in the menu tree.
- Enter the following values in the free positions after the default values (35 to 37 in this case):

Dial Plan	Name	Dialed digits	Route table
32	Standard	88CZ	1
33	IP Network	-Z	13
34	CO Internat	0C0049-Z	14
35	Node 2 Inter	0C0049230266719-Z	16
36	Node 2 NAT	0C0230266719-Z	16
37	Node 2 Stn.	0C66719-Z	16

- Click on **Apply** followed by **OK**.
- In the menu tree, click on the associated **Dial Rule** for node 2.
  - Under **Rule Name**, enter the value **Node 2**.
  - Under **Dial rule format**, enter the value **D49230266719E3A**.
  - Select **Corporate Network** as the **Network provider's method of access**.
  - Under **Type**, select the item **Country code**.
  - Click on **Apply** followed by **OK**.
- Click on **Routing table** in the menu tree.
- Click on routing table 16.
  - Under **Route**, select the item **Networking**.
  - Under **Dial Rule**, select the item **Node 2**.
  - Under **min. COS**, select the item **15**.

- d) Under **Warning**, select the item **None**.
- e) Under **Dedicated Gateway**, select the item **Forced**.
- f) Under **GW Node ID**, select the item **2**.
- g) Click on **Apply** followed by **OK**.

### 20.6.2.9 How to Configure Routes and Routing Parameters (Slave)

In the following steps, you will configure the route and routing parameters for the networking of the slave.

#### *Prerequisites*

- You are logged into the WBM with the **Expert** profile.

#### *Step by Step*

- 1) In the navigation bar, click on **Expert Mode**.
- 2) In the navigation tree, click **Telephony > Trunks/Routing**.
- 3) In the menu tree, click **Route**.
- 4) In the **Change Route** window, enter a name for the network route in the **Route Name** field, e.g., `Route 1`.
- 5) Under **Seizure code**, enter `0`.
- 6) Under **Incoming PABX number**, in the **Country code** field, enter the value `49`.
- 7) Under **Incoming PABX number**, in the **Local area code** field, enter the value `2302`.
- 8) Under **Incoming PABX number**, in the **PABX number** field, enter the value `66719`.
- 9) Select the check box **Incoming PABX number** in the **Location number** field.
- 10) The default settings for the routing parameters (No. and type, outgoing, Call number type) can be used.
- 11) Click on **Apply** followed by **OK**.

### 20.6.2.10 How to Configure Least Cost Routing (LCR) for the Network (Slave)

The default entries in index 32, 33, 34 and 35 in the LCR dial plan must be extended with further entries to enable the dialing of station numbers in "international, national and station" formats for calls to node 2. "International" and "National" are always needed. "Local" is only needed for partner nodes that are in the same local network. These entries are used for dialing from applications (e.g., myPortal for Desktop).

### Prerequisites

- You are logged into the WBM with the **Expert** profile.

### Step by Step

- In the navigation bar, click on **Expert Mode**.
- In the navigation tree, click **Telephony > LCR**.
- Click on **Dial Plan** in the menu tree.
- Enter the following values in the free positions after the default values (35 to 37 in this case):

Dial Plan	Name	Dialed digits	Route table
32	Standard	88CZ	1
33	IP Network	-Z	13
34	CO Internat	0C0049-Z	14
36	Node 1 Inter	0C0049230266758-Z	16
37	Node 1 NAT	0C00230266758-Z	16
38	Node 1 Strn.	0C66758-Z	16

- Click on **Apply** followed by **OK**.
- Click in the menu tree on **Dial Rule** for **Node 2**.
  - Under **Rule Name**, enter the value **Node 1**.
  - Under **Dial rule format**, enter the value **D49230266758E3A**.
  - Select **Corporate Network** as the **Network provider's method of access**.
  - Under **Type**, select the item **Country code**.
  - Click on **Apply** followed by **OK**.
- Click on routing table 16.
  - Under **Route**, select the item **Networking**.
  - Under **Dial Rule**, select the item **Node 1**.
  - Under **min. COS**, select the item **15**.
  - Under **Warning**, select the item **None**.
  - Under **Dedicated Gateway**, select the item **Forced**.
  - Under **GW Node ID**, select the item **2**.
  - Click on **Apply** followed by **OK**.
- Click on **Routing table** in the menu tree.

### 20.6.3 Networking OpenScape Business X and OpenScape Business S (Single Gateway)

Up to 32 OpenScape Business X/S communication systems can be networked with each other. Multiple OpenScape Business S systems are allowed in an internetwork. Single Gateway means that all IP stations registered at OpenScape Business S only use ONE gateway to the PSTN or ITSP.

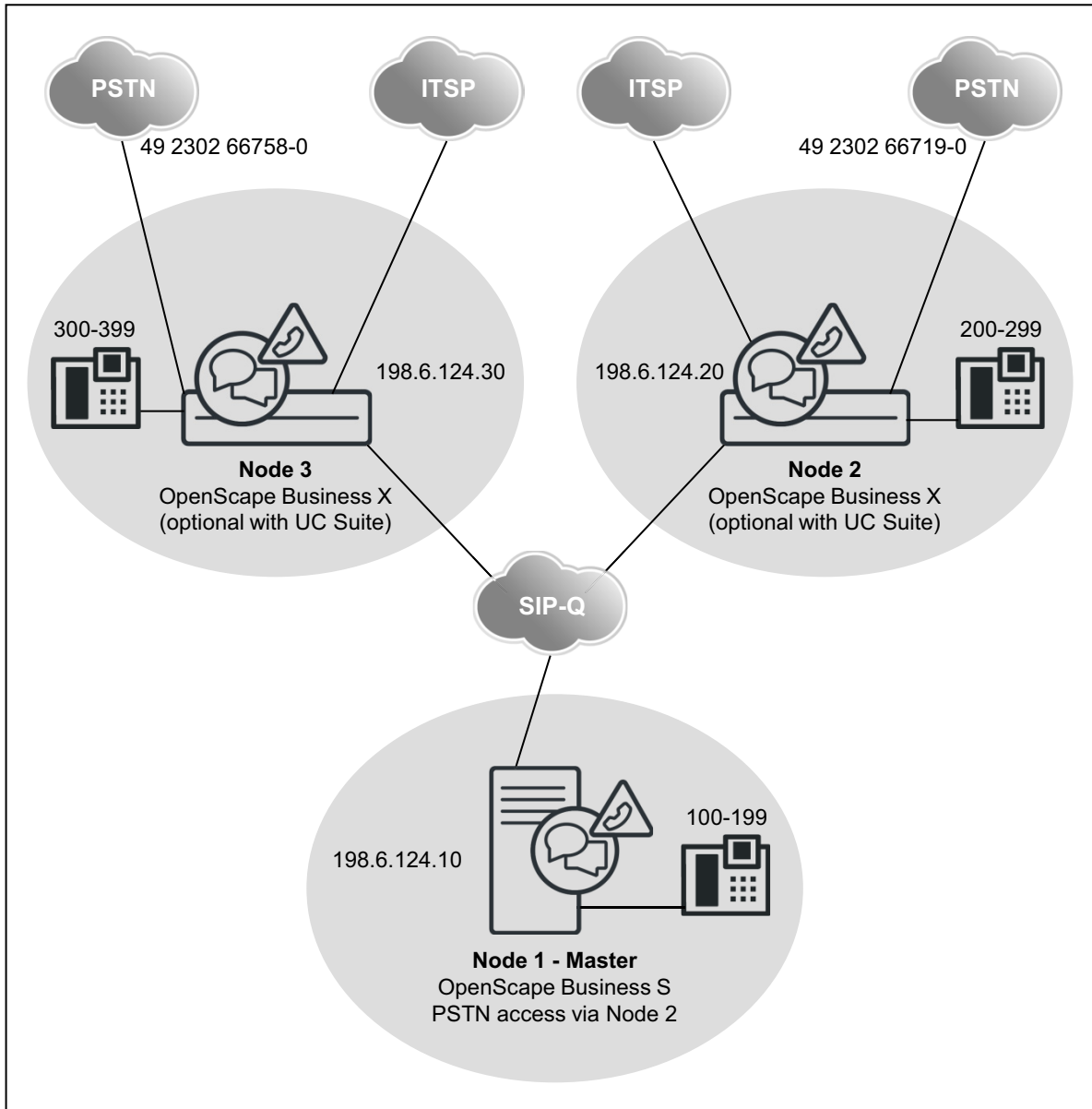

#### Network Data

- Closed numbering

- Network-wide voice and UC functionality with UC Suite configuration via WBM (wizards)
- The UC functionality is implemented either through the UC Booster Server or via the UC Booster Card
- Several OpenScope Business S in one internetwork are allowed.
- Up to 32 networked systems and 1500 users without UC solution
- Up to 8 networked systems and 1500 users with UC solution

### Network-wide Features

UC networking	Closed numbering	Open numbering
Maximum number of nodes	8 with UC solution and 32 without UC solution	
Maximum number of stations in a single communication system	Depending on OpenScope Business X	
Maximum number of stations in the network	1500	

UC networking	Closed numbering	Open numbering
UC Booster Card	UC Smart: 51 - 150 stations (0 - 50 stations without UC Booster Card) UC Suite: 0 - 150 stations	Not supported
UC Booster Server	UC Smart: from 150 stations UC Suite: from 150 stations	Not supported

Administration	Closed numbering	Open numbering
WBM	Network-wide administration using wizards	Not supported
Manager E	Network-wide administration for special tasks (not for OpenScope Business S)	Not supported
UC Suite Administration (for UC Booster Server and UC Booster Card)	Network-wide administration using wizards	Not supported
Mass data import via CSV files (call numbers, DID numbers, names)	Separately for each node in the internetwork	Not supported

Licensing	Closed numbering	Open numbering
Licensing structure	A networking license is required for each node	Not supported

### Configuration

This configuration (with closed numbering and UC Suite) shows the steps required to set up networking with the help of an example.

Prerequisites:

- A network plan is available. The network plan was used to ensure that every internal call number in the internetwork is only used once for closed numbering. Different station number lengths are allowed. Only DID station numbers may occur more than once (e.g., the CO station numbers 49 2302 66758 100 and 49 2302 66719 100 have the same DID No. 100).
- The IP network has been configured, and all nodes can be mutually pinged successfully

Call forwarding across nodes: For incoming calls over IP trunks, which have already been forwarded, no further forwardings to the voicemail box are executed. This is because no unique assignment to the voicemail box can otherwise be made

If cross-node deputy rules (referral extensions) are required, this must be set up via the profiles of the OpenScape Business stations or ringing groups. The corresponding cross-node calls are not signaled as forwarded in this case, but as DSS (direct station selection) calls. Call forwardings of the deputy are therefore forwarded to the voicemail box.

In an internetwork in which the activation period is being used, the CLA of OpenScape Business S must always as be used as the central CLA!

Due to the different amounts of the upper limits, two different activation period files are required for OpenScape Business and OpenScape Business S. The activation period file for OpenScape Business S includes the OpenScape Business base in addition to the S base for networking scenarios.

In this scenario, whenever an OpenScape Business requests a license from a CLA of the OpenScape Business S during the activation period, the limits of the OpenScape Business S are used.

By contrast, if the CLA of the OpenScape Business were to be used instead, NO activation period would be granted to any requesting OpenScape Business S, since no basis for OpenScape Business S is included in this file.

**Table:** Setting up the Location Data for Node 1, OpenScape Business S

Node 1		
G.-Location Country		49
G.-Location Local Network		2302
G.-Location System		66719
International Prefix		00
National Prefix		0
<b>Routes</b>		
Trk. Grp 1	Trunk code	0
Networking	2nd trunk code	0
<b>Routing parameters</b>		
Route	No. and type, outgoing	RNR type
Networking	Unknown	Int/DID
ISDN	(No change in entry)	DID



The station numbers of all stations outside node 1 are automatically entered in the routing tables. This includes the internal station numbers as well as the DID station numbers, which differ from the respective internal station numbers.

**Table:** Overview of Entries in the LCR for Node 1

Dial Plan		Routing table			Dial Rule		
Name	Dialed digits	Route	Dedicated Gateway	Gateway ID	Dial Rule	Procedure	Type
Node 2 Internat	0C004923026 6719-2Z	Networking	Mandatory	2	D492302667 19E3A	Corp. Network	International
Node 2 NAT	0C023026671 9-2Z						
Node 2 Stn.	0C66719-2Z						
Node 3 Internat	0C004923026 6758-3Z	Networking	Mandatory	3	D492302667 58E3A	Corp. Network	International
Node 3 NAT	0C023026675 8-3Z						
Node 3 Stn.	0C66758-3Z						
CO	0CZ	Networking	Mandatory	2	E1A	Main network supplier	Unknown
Various	-Z	Networking	No		A	Corp. Network	Unknown

**Table:** Setting up the Location Data for Node 2, OpenScope Business

Node 2		
G.-Location Country	49	
G.-Location Local Network	2302	
G.-Location System	66719	
International Prefix	00	
National Prefix	0	
<b>Routes</b>		
ISDN	Trunk code	0
Networking	2nd trunk code	0
<b>Routing parameters</b>		
Route	No. and type, outgoing	RNR type
Networking	Unknown	Int/DID
ISDN	(No change in entry)	DID

The station numbers of all stations outside node 2 are automatically entered in the routing tables. This includes the internal station numbers as well as the DID station numbers, which differ from the respective internal station numbers.

**Table:** Overview of Entries in the LCR for Node 2

Dial Plan		Routing table			Dial Rule		
Name	Dialed digits	Route	Dedicated Gateway	Gateway ID	Dial Rule	Procedure	Type
Node 1 Internat	0C004923026 6719-1Z	Networking	Mandatory	1	D492302667 19E3A	Corp. Network	International
Node 1 NAT	0C023026671 9-1Z						
Node 1 Strn.	0C66719-1Z						
Node 3 Internat	0C004923026 6758-3Z	Networking	Mandatory	3	D492302667 58E3A	Corp. Network	International
Node 3 NAT	0C023026675 8-3Z						
Node 3 Strn.	0C66758-3Z						
CO	0CZ	ISDN	No		A	Main network supplier	Unknown
Various	-Z	Networking	No		A	Corp. Network	Unknown

**Table:** Setting up the Location Data for Node 3, OpenScape Business

Node 3		
G.-Location Country		49
G.-Location Local Network		2302
G.-Location System		66758
International Prefix		00
National Prefix		0
<b>Routes</b>		
ISDN	Trunk code	0
Networking	2nd trunk code	0
<b>Routing parameters</b>		
Route	No. and type, outgoing	RNR type
Networking	Unknown	Int/DID
ISDN	(No change in entry)	DID

The station numbers of all stations outside node 3 are automatically entered in the routing tables. This includes the internal station numbers as well as the DID station numbers, which differ from the respective internal station numbers.

**Table:** Overview of Entries in the LCR for Node 3

Dial Plan		Routing table			Dial Rule		
Name	Dialed digits	Route	Dedicated Gateway	Gateway ID	Dial Rule	Procedure	Type
Node 1 Internat	0C0049230266719-1Z	Networking	Mandatory	1	D49230266719E3A	Corp. Network	International
Node 1 NAT	0C0230266719-1Z						
Node 1 Stn.	0C66719-1Z						
Node 2 Internat	0C0049230266719-2Z	Networking	Mandatory	2	D49230266719E3A	Corp. Network	International
Node 2 NAT	0C0230266719-2Z						
Node 2 Stn.	0C66719-2Z						
CO	0CZ	ISDN	No		A	Main network supplier	Unknown
Various	-Z	Networking	No		A	Corp. Network	Unknown

Procedure to Set up Networking:

1. Configure the basic installation for node 1 (master)
2. Configuring Networking for Node 1
3. Configure the basic installation for node 2 (slave)
4. Configuring Networking for Node 2
5. Configure the basic installation for node 3 (slave)
6. Configure networking for node 3 (slave)
7. Verify the networking function for the master
8. Configure LCR for networking (node 1, master)
9. Configure LCR for networking (node 2)
10. Configure routes and routing parameters (node 3)
11. Configure routes and routing parameters (Trk. Grp. 16) (Node 3)
12. Configure LCR for networking (node 3)

### 20.6.3.1 How to Configure the Basic Installation for Node 1 (Master)

For integration in an internetwork, the country code and a node ID must be assigned. The internal station numbers must be uniquely configured throughout the network. The entry of the national and local station numbers is important, since this station number is set in the Trk. Grp. 1 ISDN trunk and used as the location number for normalization.

#### **Prerequisites**

- You are logged on to the WBM with the **Advanced** profile.

### Step by Step

- 1) In the navigation bar, click on **Setup**.
- 2) In the navigation tree, click on **Wizards > Basic Installation**.
- 3) In the **Country Code** field, enter the country code prefix, e.g., 49 for Germany.
- 4) Enter the **Area Code** and **PABX number**.
- 5) Select the **Network Integration** check box.
- 6) In the **Node ID** field, assign a unique node ID in the internetwork for OpenScape Business S. The node ID must be between "1" and "100" (select "1" for the configuration example).
- 7) Click on **Execute function**. You are taken to the **Central Functions for Stations** window.
- 8) Since all internal station numbers must be unique in a network, the standard station numbers must be deleted. Enable the **Delete all station call numbers** radio button.
- 9) Enable the check box **Delete all station numbers** and click **OK & Next**. You are taken to the **Change preconfigured call and functional numbers** window.

---

**INFO:** The function codes must be unique in the internetwork.  
Duplicate station numbers are not allowed!

---

- 10) Adapt the preconfigured station numbers to the station numbers in the network and click **OK & Next**. You can optionally adapt the station numbers manually via the wizard or import a CSV file with the appropriately prepared station numbers.
- 11) Import the IP clients.
- 12) Now configure the Internet telephony.
- 13) Edit the settings for a Meet-Me conference. You must enter a code that is unique in the internetwork.
- 14) Now configure the sending of e-mails.
- 15) Click on **OK & Next**.
- 16) Click on **Finish**.

### 20.6.3.2 How to Configure Networking for Node 1 (Master)

In the next step, the Network Configuration wizard is used to configure the networking for node 1 (master).

#### Prerequisites

- You are logged on to the WBM with the **Advanced** profile.

### Step by Step

- 1) In the navigation bar, click on **Setup**.
- 2) In the navigation tree, click **Wizards > Basic Installation**.
- 3) Click on **Edit** to start the **Networking Configuration** wizard.
- 4) Select the **Network with OSBiz X / S OSBiz S** setting.
- 5) Define the node type (**Master**).
- 6) Under **Node ID**, enter the appropriate node numbers of the associated OpenScape Business systems (in the configuration example, those of the slaves with node ID 2).
- 7) Under **IP Address**, enter the IP addresses of the associated OpenScape Business systems (in the configuration example, those of the slaves with node IDs 2 and 3).
- 8) Select the check box **Gateway**.
- 9) Under **Name**, enter the type of system.
- 10) Under **Type**, enter the type of the subsystem.
- 11) Enable the **Encryption Required** check box if required.

---

**INFO:** The encryption is based on SPE and does not apply to the applications!

---

---

**NOTICE:** Note that the encryption is not configured by simply enabling the check box. See [Signaling and Payload Encryption \(SPE\)](#).

---

- 12) Click on **Finish**.

### 20.6.3.3 How to Configure the Basic Installation for Node 2 (Slave)

For integration in an internetwork, the country code and a node ID must be assigned. The internal station numbers must be uniquely configured throughout the network. The entry of the national and local station numbers is important, since this station number is set in the Trk. Grp. 1 ISDN trunk and used as the location number for normalization.

#### Prerequisites

- You are logged on to the WBM with the **Advanced** profile.

### Step by Step

- 1) In the navigation bar, click on **Setup**.
- 2) In the navigation tree, click on **Wizards > Basic Installation**.

- 3) In the **Country Code** field, enter the country code prefix, e.g., 49 for Germany.
- 4) Enter the **Area Code** and **PABX number**.
- 5) Select the **Network Integration** check box.
- 6) In the **Node ID** field for an OpenScape Business, enter a node ID that is unique in the internetwork (a "2" and a "3" for the configuration example).
- 7) Click on **Execute function**. You are taken to the **Central Functions for Stations** window.
- 8) Since all internal station numbers must be unique in a network, the standard station numbers must be deleted. Enable the **Delete all station call numbers** radio button.
- 9) Enable the check box **Delete all station numbers** and click **OK & Next**. You are taken to the **Change preconfigured call and functional numbers** window.

---

**INFO:** The function codes must be unique in the internetwork.  
Duplicate station numbers are not allowed!

---

- 10) Adapt the preconfigured station numbers to the station numbers in the network and click **OK & Next**. You can optionally adapt the station numbers manually via the wizard or import a CSV file with the appropriately prepared station numbers.
- 11) Now configure the ISDN and analog stations.
- 12) Edit the settings for a Meet-Me conference. You must enter a code that is unique in the internetwork.
- 13) Now configure the sending of e-mails.
- 14) Click on **OK & Next**.
- 15) Click on **Finish**.

#### 20.6.3.4 How to Configure Networking for Node 2 (Slave)

In the next step, the Network Configuration wizard is used to configure the networking of node 2.

##### **Prerequisites**

- You are logged on to the WBM with the **Advanced** profile.

##### **Step by Step**

- 1) In the navigation bar, click on **Setup**.
- 2) In the navigation tree, click **Wizards > Basic Installation**.
- 3) Click on **Edit** to start the **Networking Configuration** wizard.

- 4) Select the **Network with OSBiz X / S OSBiz S** setting.
- 5) Under **Node type** , select the check box **This system is a SLAVE node**.
- 6) **Enter die IP address of the MASTER node** (in the configuration example, the IP address of node 1).

---

**INFO:** Note that this action cannot be undone after clicking **OK & Next!**

---

- 7) The **Registration Status** displays **Status successful** (or a corresponding error message). This completes the wizard.
- 8) Click on **Finish**.

### 20.6.3.5 How to Configure the Basic Installation for Node 3 (Slave)

For integration in an internetwork, the country code and a node ID must be assigned. The internal station numbers must be uniquely configured throughout the network. The entry of the national and local station numbers is important, since this station number is set in the Trk. Grp. 1 ISDN trunk and used as the location number for normalization.

#### *Prerequisites*

- You are logged on to the WBM with the **Advanced** profile.

#### *Step by Step*

- 1) In the navigation bar, click on **Setup**.
- 2) In the navigation tree, click on **Wizards > Basic Installation**.
- 3) In the **Country Code** field, enter the country code prefix, e.g., 49 for Germany.
- 4) Enter the **Area Code** and **PABX number**. (identical to the assigned gateway system).
- 5) Select the **Network Integration** check box.
- 6) In the **Node ID** field for OpenScape Business, enter a node ID that is unique in the internetwork (a "3" for the configuration example).
- 7) Click on **Execute function**. You are taken to the **Central Functions for Stations** window.
- 8) Since all internal station numbers must be unique in a network, the standard station numbers must be deleted. Enable the **Delete all station call numbers** radio button.
- 9) Enable the check box **Delete all station numbers** and click **OK & Next**. You are taken to the **Change preconfigured call and functional numbers** window.

---

**INFO:** The function codes must be unique in the internetwork.  
Duplicate station numbers are not allowed!

---

- 10) Adapt the preconfigured station numbers to the station numbers in the network and click **OK & Next**. You can optionally adapt the station numbers manually via the wizard or import a CSV file with the appropriately prepared station numbers.
- 11) Now configure the ISDN and analog stations.
- 12) Edit the settings for a Meet-Me conference. You must enter a code that is unique in the internetwork.
- 13) Now configure the sending of e-mails.
- 14) Click on **OK & Next**.
- 15) Click on **Finish**.

### 20.6.3.6 How to Verify the Networking Function for the Master

You can verify the status of the network in general and also the individual station numbers.

#### *Prerequisites*

- You are logged on to the WBM with the **Advanced** profile.

#### *Step by Step*

- 1) In the navigation bar, click on **Network**.
- 2) The status bar shows the **Synchronization status** for the network. Green means that there are no networking problems; red indicates problems in the network.
- 3) Selecting the **Domain View** tab in the **Network** window shows all available nodes with the **Node ID, Name, System Type, Server Address, Registration Status** and **Availability Status**.
- 4) Selecting the **Phone Numbers** tab in the **Network** window opens a window with all the relevant details on the following:
  - Call number**
  - DID**
  - Name**
  - Port Type**
  - Nodes**



### 20.6.3.7 Configure networking for node 3 (slave)

In the next step, the Network Configuration wizard is used to configure the networking for node 3.

#### *Prerequisites*

- You are logged on to the WBM with the **Advanced** profile.

#### *Step by Step*

- 1) In the navigation bar, click on **Setup**.
- 2) In the navigation tree, click **Wizards > Basic Installation**.
- 3) Click on **Edit** to start the **Networking Configuration** wizard.
- 4) Select the **Network with OSBiz X / S OSBiz S** setting.
- 5) Under **Node type**, select the check box **This system is a SLAVE node**.
- 6) **Enter the IP address of the MASTER node** (in the configuration example, the IP address of node 1).

---

**INFO:** Note that this action cannot be undone after clicking **OK & Next!**

---

- 7) The **Registration Status** displays **Status successful** (or a corresponding error message). This completes the wizard.
- 8) Click on **Finish**.

### 20.6.3.8 How to Configure Least Cost Routing (LCR) for the Network (Node 3, Slave)

The default entries in index 32, 33, 34 and 35 in the LCR dial plan must be extended with further entries to enable the dialing of station numbers in "international, national and station" formats for calls to nodes 1 and 2. "International" and "National" are always needed. "Local" is only needed for partner nodes that are in the same local network. The entries 36, 37 and 39 for interworking with node 1 (station numbers 100 > 199) and the entries 39, 40 and 41 for interworking with node 2 (station numbers 200 > 299) must be extended. These entries are used for dialing from applications (e.g., myPortal for Desktop).

#### *Prerequisites*

- You are logged into the WBM with the **Expert** profile.

#### *Step by Step*

- 1) In the navigation bar, click on **Expert Mode**.
- 2) In the navigation tree, click **Telephony > LCR**.
- 3) Click on **Dial Plan** in the menu tree.

- 4) Enter the following values in the free positions after the default values (35 to 40 in this case):

Dial Plan	Name	Dialed digits	Route table
31	Appl-Suite	-371	12
32	Standard	88CZ	1
33	IP Network	-Z	13
34	CO Internat	0C0049-Z	14
36	Node 1 Inter	0C0049230266719-1Z	16
37	Node 1 NAT	0C0230266719-1Z	16
38	Node 1 Stn.	0C66719-1Z	16
39	Node 2 Inter	0C0049230266719-2Z	17
40	Node 2 NAT	0C0230266719-2Z	17
41	Node 2 Stn.	0C66719-2Z	17

- 5) Click on **Apply** followed by **OK**.
- 6) In the menu tree, click on the associated **Dial Rule** for nodes 1 and 2.
- Under **Rule Name**, enter the value **Node 1 + 2**.
  - Under **Dial rule format**, enter the value **D49230266719E3A**.
  - Select **Corporate Network** as the **Network provider's method of access**.
  - Under **Type**, select the item **Country code**.
  - Click on **Apply** followed by **OK**.
- 7) Click on **Routing table** in the menu tree to configure routing table 16 for networking and to assign it directly to node 1.
- 8) Click on routing table 16.
- Under **Route**, select the item **Networking**.
  - Under **Dial Rule**, select the item **Nodes 1 + 2**.
  - Under **min. COS**, select the item **15**.
  - Under **Warning**, select the item **None**.
  - Under **Dedicated Gateway**, select the item **Forced**.
  - Under **GW Node ID**, select the item **1**.
  - Click on **Apply** followed by **OK**.
- 9) Click on **Routing table** in the menu tree to configure routing table 17 for networking and to assign it directly to node 2.
- 10) Click on routing table 17.
- Under **Route**, select the item **Networking**.
  - Under **Dial Rule**, select the item **Nodes 1 + 2**.

- c) Under **min. COS**, select the item **15**.
- d) Under **Warning**, select the item **None**.
- e) Under **Dedicated Gateway**, select the item **Forced**.
- f) Under **GW Node ID**, select the item **2**.
- g) Click on **Apply** followed by **OK**.

### 20.6.3.9 How to Configure LCR for Networking (Node 2)

The default entries in index 32, 33, 34 and 35 in the LCR dial plan must be extended with further entries to enable the dialing of station numbers in "international, national and station" formats for calls to nodes 1 and 3. "International" and "National" are always needed. "Local" is only needed for partner nodes that are in the same local network. The entries 36, 37 and 38 for interworking with node 1 (station numbers 100 > 199) and the entries 39, 40 and 41 for interworking with node 3 (station numbers 300 > 399) must be extended. These entries are used for dialing from applications (e.g., myPortal for Desktop).

#### Prerequisites

- You are logged into the WBM with the **Expert** profile.

#### Step by Step

- 1) In the navigation bar, click on **Expert Mode**.
- 2) In the navigation tree, click **Telephony > LCR**.
- 3) Click on **Dial Plan** in the menu tree.
- 4) Enter the following values in the free positions after the default values (35 to 40 in this case):

Dial Plan	Name	Dialed digits	Route table
31	Appl-Suite	-271	12
32	Standard	88CZ	1
33	IP Network	-Z	13
34	CO Internat	0C0049-Z	14
36	Node 1 Inter	0C0049230266719-1Z	16
37	Node 1 NAT	0C0230266719-1Z	16
38	Node 1 Stn.	0C66719-1Z	16
39	Node 3 Inter	0C0049230266758-3Z	17
40	Node 3 NAT	0C0230266758-3Z	17
41	Node 3 Stn.	0C66758-3Z	17

- 5) Click on **Apply** followed by **OK**.
- 6) Click on **Routing table** in the menu tree.

- 7) In the menu tree, click on the associated **Dial Rule** for node 1.
  - a) Under **Rule Name**, enter the value **Node 1**.
  - b) Under **Dial rule format**, enter the value **D49230266719E3A**.
  - c) Select **Corporate Network** as the **Network provider's method of access**.
  - d) Under **Type**, select the item **Country code**.
  - e) Click on **Apply** followed by **OK**.
- 8) Click on routing table 16 to configure it for node 1 networking.
  - a) Under **Route**, select the item **Networking**.
  - b) Under **Dial Rule**, select the item **Node 1**.
  - c) Under **min. COS**, select the item **1**.
  - d) Under **Warning**, select the item **None**.
  - e) Under **Dedicated Gateway**, select the item **Forced**.
  - f) Under **GW Node ID**, select the item **1**.
  - g) Click on **Apply** followed by **OK**.
- 9) In the menu tree, click on the associated **Dial Rule** for node 3.
  - a) Under **Rule Name**, enter the value **Node 3**.
  - b) Under **Dial rule format**, enter the value **D49230266758E3A**.
  - c) Select **Corporate Network** as the **Network provider's method of access**.
  - d) Under **Type**, select the item **Country code**.
  - e) Click on **Apply** followed by **OK**.
- 10) Click on **Routing table** in the menu tree.
- 11) Click on routing table 17 to configure it for node 3 networking.
  - a) Under **Route**, select the item **Networking**.
  - b) Under **Dial Rule**, select the item **Node 3**.
  - c) Under **min. COS**, select the item **1**.
  - d) Under **Warning**, select the item **None**.
  - e) Under **Dedicated Gateway**, select the item **Forced**.
  - f) Under **GW Node ID**, select the item **3**.
  - g) Click on **Apply** followed by **OK**.

### 20.6.3.10 How to Configure Routes and Routing Parameters (Node 1, Master)

In node 1, the settings for the CO trunk must be configured with respect to the location number, seizure code and routing parameters. The PABX number for

defining the gateway location must be entered here. These entries are used for dialing from applications such as myPortal, for example.

### **Prerequisites**

- You are logged into the WBM with the **Expert** profile.

### **Step by Step**

- 1) In the navigation bar, click on **Expert Mode**.
- 2) In the navigation tree, click **Telephony > Trunks/Routing**.
- 3) In the menu tree, click **Route**.
- 4) In the **Change Route** window, enter a name for the CO trunk in the **Route Name** field, e.g., *Route 1*.
- 5) Under **Seizure code**, enter 0.
- 6) Under **Incoming PABX number**, in the **Country code** field, enter the value 49.
- 7) Under **Incoming PABX number**, in the **Local area code** field, enter the value 2302.
- 8) Under **Incoming PABX number**, in the **PABX number** field, enter the value 66719.
- 9) Select the check box **Incoming PABX number** in the **Location number** field.
- 10) The default settings for the routing parameters (No. and type, outgoing, Call number type) can be used.
- 11) Click on **Apply** followed by **OK**.

## **20.6.3.11 How to Configure Routes and Routing Parameters (Trk. Grp. 16, Node 1)**

For route 64 (networking), the entry for the 2nd trunk code is mandatory for the master and slave and must be filled in.

### **Prerequisites**

- You are logged into the WBM with the **Expert** profile.

### **Step by Step**

- 1) In the navigation bar, click on **Expert Mode**.
- 2) In the navigation tree, click **Telephony > Trunks/Routing**.
- 3) In the menu tree, click on the last **Route (Route 16)**.
- 4) In the **Change Route** window, enter a name for the network route in the **Route Name** field, e.g., *Networking*.
- 5) Do not enter anything for the **Seizure code**.

- 6) Enter a "0" under **CO code (2nd trunk code)** .
- 7) The default settings for the routing parameters (No. and type, outgoing, Call number type) can be used.
- 8) Click on **Apply** followed by **OK**.

### 20.6.3.12 How to Configure Least Cost Routing (LCR) for the Network (Node 1)

The default entries in index 32, 33, 34 and 35 in the LCR dial plan must be extended with further entries to enable the dialing of station numbers in "international, national and station" formats for calls to nodes 2 and 3. "International" and "National" are always needed. "Local" is only needed for partner nodes that are in the same local network. These entries are used for dialing from applications (e.g., myPortal for Desktop).

#### Prerequisites

- You are logged into the WBM with the **Expert** profile.

#### Step by Step

- 1) In the navigation bar, click on **Expert Mode**.
- 2) In the navigation tree, click **Telephony > LCR**.
- 3) Click on **Dial Plan** in the menu tree.
- 4) Enter the following values in the free positions after the default values (35 to 40 in this case):

Dial Plan	Name	Dialed digits	Route table
16	Standard	0CZ	1
17	Standard	0C1Z	1
18	Standard	0CNZ	1
32	Standard	88CZ	1
33	IP Network	-Z	13
34	CO Internat	0C0049-Z	14
36	Node 2 Inter	0C0049230266719-2Z	16
37	Node 2 NAT	0C0230266719-2Z	16
38	Node 2 Stn.	0C66719-2Z	16
39	Node 3 Inter	0C0049230266758-3Z	17
40	Node 3 NAT	0C0230266758-3Z	17
41	Node 3 Stn.	0C66758-3Z	17

- 5) Click on **Apply** followed by **OK**.
- 6) In the menu tree, click on the associated **Dial Rule** for node 2.
  - a) Under **Rule Name**, enter the value **Node 2**.

- b) Under **Dial rule format**, enter the value **D49230266719E3A**.
  - c) Select **Corporate Network** as the **Network provider's method of access**.
  - d) Under **Type**, select the item **Country code**.
  - e) Click on **Apply** followed by **OK**.
- 7) Click on **Routing table** in the menu tree.
- 8) Click on routing table 16 to configure it for node 2 networking.
- a) Under **Route**, select the item **Networking**.
  - b) Under **Dial Rule**, select the item **Node 2**.
  - c) Under **min. COS**, select the item **1**.
  - d) Under **Warning**, select the item **None**.
  - e) Under **Dedicated Gateway**, select the item **Forced**.
  - f) Under **GW Node ID**, select the item **2**.
  - g) Click on **Apply** followed by **OK**.
- 9) In the menu tree, click on the associated **Dial Rule** for node 3.
- a) Under **Rule Name**, enter the value **Node 3**.
  - b) Under **Dial rule format**, enter the value **D49230266719E1A**.
  - c) Select **Corporate Network** as the **Network provider's method of access**.
  - d) Under **Type**, select the item **Country code**.
  - e) Click on **Apply** followed by **OK**.
- 10) Click on **Routing table** in the menu tree.
- 11) Click on routing table 17 to configure it for node 3 networking.
- a) Under **Route**, select the item **Networking**.
  - b) Under **Dial Rule**, select the item **Node 3**.
  - c) Under **min. COS**, select the item **1**.
  - d) Under **Warning**, select the item **None**.
  - e) Under **Dedicated Gateway**, select the item **Forced**.
  - f) Under **GW Node ID**, select the item **3**.
  - g) Click on **Apply** followed by **OK**.
- 12) Click on **Routing table** in the menu tree.

## 20.6.4 Networking OpenScape Business X and OpenScape Business S (Multi-Gateway)

Up to 32 OpenScape Business X and OpenScape Business S communication systems can be networked with one another. Multi-gateway means that every IP station registered at OpenScape Business S is assigned to exactly one specific gateway.

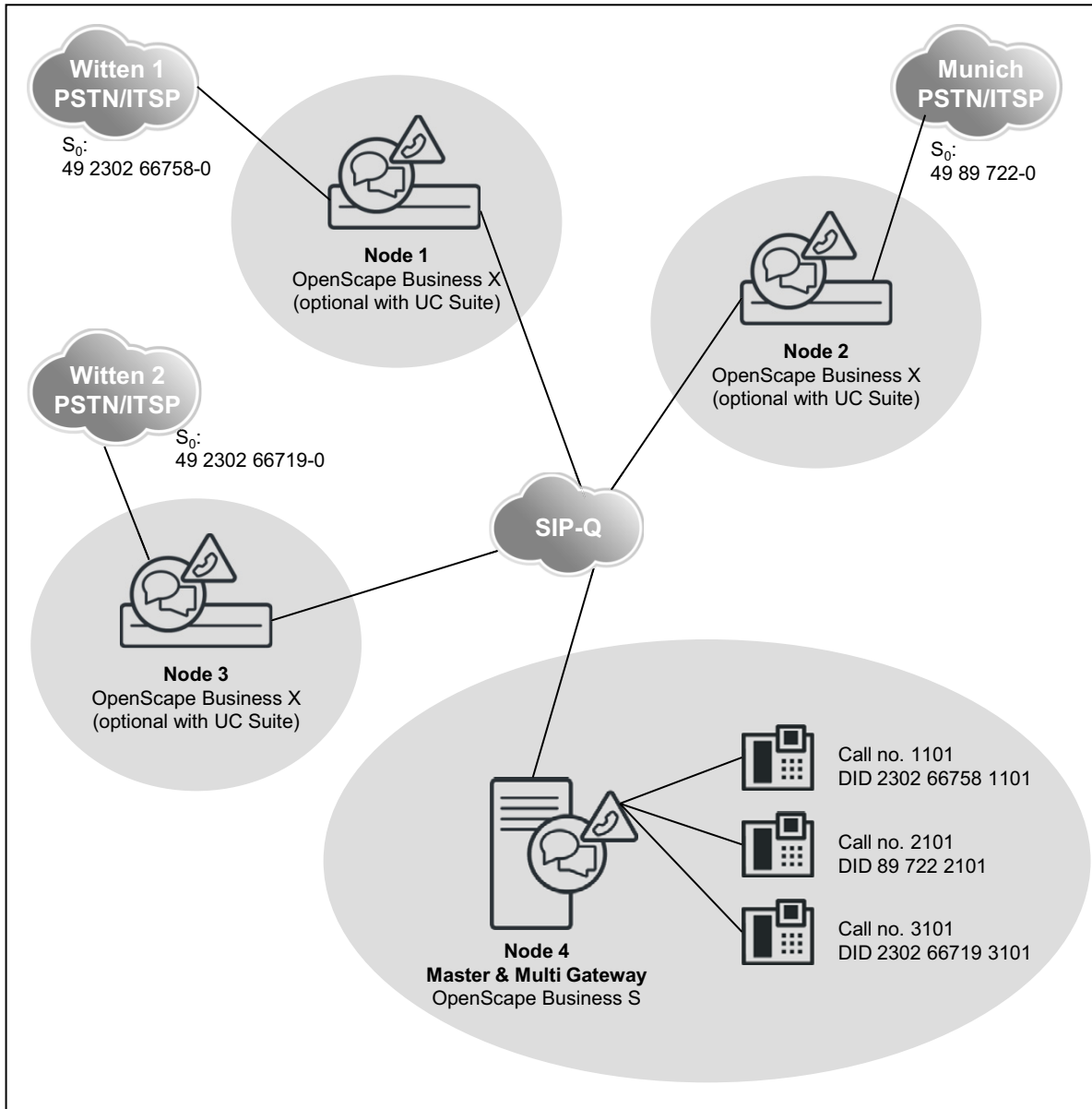

### Network Data

- Closed numbering



- Network-wide voice and UC functionality with UC Suite configuration via WBM (wizards)
- The UC functionality is implemented either through the UC Booster Server or via the UC Booster Card
- Only one OpenScape Business S in the internetwork is allowed.
- All systems must have the same country code
- All systems must be located in the same time zone
- Only one CO access code (e.g., 0) must exist for the entire network.
- Up to 32 networked systems and 1500 users without UC solution
- Up to 8 networked systems and 1500 users with UC solution

### Network-wide Features

UC networking	Closed numbering	Open numbering
Maximum number of nodes	8 with UC solution and 32 without UC solution	
Maximum number of stations in a single communication system	Depending on OpenScape Business X	
Maximum number of stations in the network	1500	

UC networking	Closed numbering	Open numbering
UC Booster Card	UC Smart: 51 - 150 stations (0 - 50 stations without UC Booster Card) UC Suite: 0 - 150 stations	Not supported
UC Booster Server	UC Smart: from 150 stations UC Suite: from 150 stations	Not supported

Administration	Closed numbering	Open numbering
WBM	Network-wide administration using wizards	Not supported
Manager E	Network-wide administration for special tasks (not for OpenScape Business S)	Not supported
UC Suite Administration (for UC Booster Server and UC Booster Card)	Network-wide administration using wizards	Not supported
Mass data import via CSV files (call numbers, DID numbers, names)	Separately for each node in the internetwork	Not supported

Licensing	Closed numbering	Open numbering
Licensing structure	A networking license is required for each node	Not supported

**Configuration**

This configuration (with closed numbering and UC Suite) shows the steps required to set up a multi-gateway network with the help of an example.

Prerequisites:

- A network plan is available. The network plan was used to ensure that every internal call number in the internetwork is only used once for closed numbering. Different station number lengths are allowed. Only DID station numbers may occur more than once
- The IP network has been configured, and all nodes can be mutually pinged successfully
- All nodes have been upgraded to the same software version

Call forwarding across nodes: For incoming calls over IP trunks, which have already been forwarded, no further forwardings to the voicemail box are executed. This is because no unique assignment to the voicemail box can otherwise be made

If cross-node deputy rules (referral extensions) are required, this must be set up via the profiles of the OpenScape Business stations or ringing groups. The corresponding cross-node calls are not signaled as forwarded in this case, but as DSS (direct station selection) calls. Call forwardings of the deputy are therefore forwarded to the voicemail box

**Table:** Setting up the Location Data for Node 1

Node 1		
G.-Location Country		49
G.-Location Local Network		2302
G.-Location System		66758
International Prefix		00
National Prefix		0
<b>Routes</b>		
ISDN	Trunk code	0
Networking	2nd trunk code	0
<b>Routing parameters</b>		
Route	No. and type, outgoing	RNR type
Networking	Unknown	Int/DID
ISDN	(No change in entry)	DID

The station numbers of all stations outside node 1 are automatically entered in the routing tables. This includes the internal station numbers as well as the DID station numbers, which differ from the respective internal station numbers.

**Table:** Overview of Entries in the LCR for Node 1

Dial Plan		Routing table			Dial Rule		
Name	Dialed digits	Route	Dedicated Gateway	Gateway ID	Dial Rule	Procedure	Type
Node 2 Internat	0C004989722-Z	Networking	Mandatory	2	D4989722E3A	Corp. Network	International
Node 2 NAT	0C089722-Z						
Node 2 Stn.	0C722-Z						
Node 3 Internat	0C0049230266719-Z	Networking	Mandatory	3	D49230266719E3A	Corp. Network	International
Node 3 NAT	0C0230266719-Z						
Node 3 Stn.	0C66719-Z						
Node 4 Internat	0C0049230266758-Z	Networking	NO		D230266758E3A	Corp. Network	National
Node 4 NAT	0C0230266758-Z						
Node 4 Stn.	0C66758-Z						
Various	-Z	Networking	No		BA	Corp. Network	Unknown
CO International	0C0049-Z	ISDN	No		D0E3A	Main network supplier	Unknown
CO	0CZ	ISDN	No		A	Main network supplier	Unknown

**Table:** Setting up the Location Data for Node 2

Node 2		
G-Location Country		49
G-Location Local Network		89
G-Location System		722
International Prefix		00
National Prefix		0
<b>Routes</b>		
ISDN	Trunk code	0
Networking	2nd trunk code	0
<b>Routing parameters</b>		
Route	No. and type, outgoing	RNR type
Networking	Unknown	Int/DID
ISDN	(No change in entry)	DID

The station numbers of all stations outside node 2 are automatically entered in the routing tables. This includes the internal station numbers as well as the DID station numbers, which differ from the respective internal station numbers.

**Table:** Overview of Entries in the LCR for Node 2

Dial Plan		Routing table			Dial Rule		
Name	Dialed digits	Route	Dedicated Gateway	Gateway ID	Dial Rule	Procedure	Type
Node 1 Internat	0C0049230266758-Z	Networking	Mandatory	1	D492302667E3A	Corp. Network	International
Node 1 NAT	0C0230266758-Z						
Node 1 Stn.	0C66758-Z						
Node 3 Internat	0C0049230266719-Z	Networking	Mandatory	3	D49230266719E3A	Corp. Network	International
Node 3 NAT	0C0230266719-Z						
Node 3 Stn.	0C66719-Z						
Node 4 Internat	0C004989722-Z	Networking	NO		D89722E3A	Corp. Network	National
Node 4 NAT	0C089722-Z						
Node 4 Stn.	0C722-Z						
Various	-Z	Networking	No		BA	Corp. Network	Unknown
CO International	0C0049-Z	ISDN	No		D0E3A	Main network supplier	Unknown
CO	0CZ	ISDN	No		A	Main network supplier	Unknown

**Table:** Setting up the Location Data for Node 3

Node 3		
G.-Location Country		49
G.-Location Local Network		2302
G.-Location System		66719
International Prefix		00
National Prefix		0
<b>Routes</b>		
ISDN	Trunk code	0
Networking	2nd trunk code	0
<b>Routing parameters</b>		
Route	No. and type, outgoing	RNR type
Networking	Unknown	Int/DID
ISDN	(No change in entry)	DID

The station numbers of all stations outside node 3 are automatically entered in the routing tables. This includes the internal station numbers as well as the DID station numbers, which differ from the respective internal station numbers.

**Table:** Overview of Entries in the LCR for Node 3

Dial Plan		Routing table			Dial Rule		
Name	Dialed digits	Route	Dedicated Gateway	Gateway ID	Dial Rule	Procedure	Type
Node 1 Internat	0C0049230266758-Z	Networking	Mandatory	1	D49230266758E3A	Corp. Network	International
Node 1 NAT	0C0230266758-Z						
Node 1 Stn.	0C66758-Z						
Node 2 Internat	0C004989722-Z	Networking	Mandatory	2	D4989722E3A	Corp. Network	International
Node 2 NAT	0C089722-Z						
Node 2 Stn.	0C722-Z						
Node 4 Internat	0C004989230266719-Z	Networking	No		D230266719E3A	Corp. Network	National
Node 4 NAT	0C0230266719-Z						
Node 4 Stn.	0C66719-Z						
Various	-Z	Networking	No		BA	Corp. Network	Unknown
CO International	0C0049-Z	ISDN	No		D0E3A	Main network supplier	Unknown
CO	0CZ	ISDN	No		A	Main network supplier	Unknown

Setting up the Location Data for Node 4: Associate location data with a dummy CO trunk (Trk. Grp. 1) incl. CO access code = 0 and Type = CO, since node 4 has no direct connection to a Central Office.

**Table:** Node 4, dummy CO trunk

Node 4		
G-Location Country		49
G-Location Local Network		
G-Location System		
International Prefix		00
National Prefix		0
<b>Routes</b>		
ISDN	Trunk code	0
Networking	2nd trunk code	0
<b>Routing parameters</b>		
Route	No. and type, outgoing	RNR type
Networking	Unknown	Int/DID
ISDN	(No change in entry)	DID

The station numbers of all stations outside node 1 are automatically entered in the routing tables. This includes the internal station numbers as well as the DID station numbers, which differ from the respective internal station numbers.

**Table:** Node 4, Networking Route

Node 4		
G.-Location Country		
G.-Location Local Network		
G.-Location System		
International Prefix	00	
National Prefix	0	
<b>Routes</b>		
ISDN	Trunk code	0
Networking	2nd trunk code	0
<b>Routing parameters</b>		
Route	No. and type, outgoing	RNR type
Networking	National	Int/DID
ISDN	(No change in entry)	DID

**Table:** Overview of Entries in the LCR for Node 4

Dial Plan		Routing table			Dial Rule		
Name	Dialed digits	Route	Dedicated Gateway	Gateway ID	Dial Rule	Procedure	Type
Node 1 Internat	0C0049230266758-Z	Networking	Mandatory	1	D49230266758E3A	Corp. Network	International
Node 1 NAT	0C0230266758-Z						
Node 2 Internat	0C004989722-Z	Networking	Mandatory	2	D4989722E3A	Corp. Network	International
Node 2 NAT	0C089722-Z						
Node 3 Internat	0C004989230266719-Z	Networking	Mandatory	3	D49230266719E3A	Corp. Network	International
Node 3 NAT	0C0230266719-Z						
Various	-Z	Networking	NO		A	Corp. Network	Unknown
CO	0CZ	Networking	MULTI-GATEWAY	1	E1A	Main network supplier	Unknown

Procedure to Set up Networking:

1. Configure the basic installation for node 4 (master)
2. Configure networking for node 4 (master)
3. Configure the basic installation for node 1 (slave)
4. Configure networking for node 1 (slave)
5. Configure the basic installation for node 2 (slave)

6. Configure networking for node 2 (slave)
7. Configure the basic installation for node 3 (slave)
8. Configure networking for node 3 (slave)
9. Verify the networking function for the master
10. Configure a multi-gateway for node 4 (master)
11. Configure routes and routing parameters (node 1, slave)
12. Configure LCR for networking (node 1, slave)
13. Configure routes and routing parameters (node 2, slave)
14. Configure LCR for networking (node 2, slave)
15. Configure routes and routing parameters (node 3, slave)
16. Configure LCR for networking (node 3, slave)
17. Configure routes and routing parameters (node 4, master)
18. Configure LCR for networking (node 4, master)

#### 20.6.4.1 How to Configure the Basic Installation for Node 4 (OpenScape Business S, Master)

For integration in an internetwork, the country code and a node ID must be assigned. The internal station numbers must be uniquely configured throughout the network. The entry of the national and local station numbers is important, since this station number is set in the Trk. Grp. 1 ISDN trunk and used as the location number for normalization.

##### **Prerequisites**

- You are logged on to the WBM with the **Advanced** profile.

##### **Step by Step**

- 1) In the navigation bar, click on **Setup**.
- 2) In the navigation tree, click on **Wizards > Basic Installation**.
- 3) In the **Country Code** field, enter the country code prefix, e.g., 49 for Germany.
- 4) Do not make any entries in the **Area Code** and **PABX number** fields!
- 5) Select the **Network Integration** check box.
- 6) In the **Node ID** field, assign a unique node ID in the internetwork for OpenScape Business S. The node ID must be between "1" and "100" (a "1" was assigned for the configuration example).
- 7) Click on **Execute function**. You are taken to the **Central Functions for Stations** window.
- 8) Since all internal station numbers must be unique in a network, the standard station numbers must be deleted. Enable the **Delete all station call numbers** radio button.

- 9) Enable the check box **Delete all station numbers** and click **OK & Next**. You are taken to the **Change preconfigured call and functional numbers** window.

---

**INFO:** The function codes must be unique in the internetwork.  
Duplicate station numbers are not allowed!

---

- 10) Adapt the preconfigured station numbers to the station numbers in the network and click **OK & Next**. You can optionally adapt the station numbers manually via the wizard or import a CSV file with the appropriately prepared station numbers.
- 11) Now configure the IP clients.
- 12) Configure the IP clients.
- 13) Edit the settings for a Meet-Me conference. You must enter a code that is unique in the internetwork.
- 14) Now configure the sending of e-mails.
- 15) Click on **Finish**.

#### 20.6.4.2 How to Configure the Networking for Node 4 (Master)

In the next step, the Network Configuration wizard is used to configure the networking for node 3.

##### *Prerequisites*

- You are logged on to the WBM with the **Advanced** profile.

##### *Step by Step*

- 1) In the navigation bar, click on **Setup**.
- 2) In the navigation tree, click **Wizards > Basic Installation**.
- 3) Click on **Edit** to start the **Networking Configuration** wizard.
- 4) Select the **Network with OSBiz X / S OSBiz S** setting.
- 5) Select the **This system is the MASTER node** check box.
- 6) Under **Node ID**, enter the corresponding node numbers of the associated OpenScape Business systems (in the configuration example, those of the slaves with node IDs 1, 2 and 3).
- 7) Under **IP Address**, enter the IP addresses of the associated OpenScape Business systems (in the configuration example, those of the slaves with node IDs 1, 2 and 3).
- 8) Select the check box **Gateway**.
- 9) Under **Name**, enter the type of system (for example: Slave 1).
- 10) Under **Type**, enter the type of the subsystem.



- 11) Enable the **Encryption Required** check box if required.

---

**INFO:** The encryption is based on SPE and does not apply to the applications!

---

---

**NOTICE:** Note that the encryption is not configured by simply enabling the check box. See [Signaling and Payload Encryption \(SPE\)](#).

---

- 12) Click on **Finish**.

### 20.6.4.3 How to Configure the Basic Installation for Node 1 (Slave)

For integration in an internetwork, the country code and a node ID must be assigned. The internal station numbers must be uniquely configured throughout the network. The entry of the national and local station numbers is important, since this station number is set in the Trk. Grp. 1 ISDN trunk and used as the location number for normalization.

#### **Prerequisites**

- You are logged on to the WBM with the **Advanced** profile.

#### **Step by Step**

- 1) In the navigation bar, click on **Setup**.
- 2) In the navigation tree, click on **Wizards > Basic Installation**.
- 3) In the **Country Code** field, enter the country code prefix, e.g., 49 for Germany.
- 4) Enter the **Area Code** and **PABX number**.
- 5) Select the **Network Integration** check box.
- 6) In the **Node ID** field for OpenScape Business S, enter a node ID that is unique in the internetwork (a "1" for the configuration example).
- 7) Click on **Execute function**. You are taken to the **Central Functions for Stations** window.
- 8) Since all station numbers must be unique in a network, the standard station numbers must be deleted. Enable the **Delete all station call numbers** radio button.
- 9) Enable the check box **Delete all station numbers** and click **OK & Next**. You are taken to the **Change preconfigured call and functional numbers** window.

---

**INFO:** The function codes must be unique in the internetwork.  
Duplicate station numbers are not allowed!

---

- 10) Adapt the preconfigured station numbers to the station numbers in the network and click **OK & Next**. You can optionally adapt the station numbers manually via the wizard or import a CSV file with the appropriately prepared station numbers.
- 11) Now configure the ISDN and analog stations.
- 12) Edit the settings for a Meet-Me conference. You must enter a code that is unique in the internetwork.
- 13) Now configure the sending of e-mails.
- 14) Click on **Finish**.

#### 20.6.4.4 How to Configure Networking for Node 1 (Slave)

In the next step, the wizard is used to configure the networking.

##### *Prerequisites*

- You are logged on to the WBM with the **Advanced** profile.

##### *Step by Step*

- 1) In the navigation bar, click on **Setup**.
- 2) In the navigation tree, click **Wizards > Basic Installation**.
- 3) Click on **Edit** to start the **Networking Configuration** wizard.
- 4) Select the **Network with OSBiz X / S OSBiz S** setting.
- 5) **Enter the IP address of the MASTER node** (The OpenScape Business is configured as a slave node and the corresponding IP address of the master node (the OpenScape Office S) is entered. The master and multi-gateway are always assigned to the same system, which is OpenScape Business S in the configuration example).

---

**INFO:** Note that this action cannot be undone after clicking **OK & Next!**

---

- 6) The **Registration Status** displays **Status successful** (or a corresponding error message). This completes the wizard.
- 7) Click on **Finish**.

## 20.6.4.5 How to Configure the Basic Installation for Node 2 (Slave)

For integration in an internetwork, the country code and a node ID must be assigned. The internal station numbers must be uniquely configured throughout the network. The entry of the national and local station numbers is important, since this station number is set in the Trk. Grp. 1 ISDN trunk and used as the location number for normalization.

### *Prerequisites*

- You are logged on to the WBM with the **Advanced** profile.

### *Step by Step*

- 1) In the navigation bar, click on **Setup**.
- 2) In the navigation tree, click on **Wizards > Basic Installation**.
- 3) In the **Country Code** field, enter the country code prefix, e.g., 49 for Germany.
- 4) Enter the **Area Code** and **PABX number**.
- 5) Select the **Network Integration** check box.
- 6) In the **Node ID** field for OpenScape Business S, enter a node ID that is unique in the internetwork (a "2" for the configuration example).
- 7) Click on **Execute function**. You are taken to the **Central Functions for Stations** window.
- 8) Since all internal station numbers must be unique in a network, the standard station numbers must be deleted. Enable the **Delete all station call numbers** radio button.
- 9) Enable the check box **Delete all station numbers** and click **OK & Next**. You are taken to the **Change preconfigured call and functional numbers** window.

---

**INFO:** The function codes must be unique in the internetwork.  
Duplicate station numbers are not allowed!

---

- 10) Adapt the preconfigured station numbers to the station numbers in the network and click **OK & Next**. You can optionally adapt the station numbers manually via the wizard or import a CSV file with the appropriately prepared station numbers.
- 11) Now configure the ISDN and analog stations.
- 12) Edit the settings for a Meet-Me conference. You must enter a code that is unique in the internetwork.
- 13) Now configure the sending of e-mails.
- 14) Click on **Finish**.

## 20.6.4.6 How to Configure Networking for Node 2 (Slave)

In the next step, the Network Configuration wizard is used to configure the networking of node 2.

### *Prerequisites*

- You are logged on to the WBM with the **Advanced** profile.

### *Step by Step*

- 1) In the navigation bar, click on **Setup**.
- 2) In the navigation tree, click **Wizards > Basic Installation**.
- 3) Click on **Edit** to start the **Networking Configuration** wizard.
- 4) Select the **Network with OSBiz X / S OSBiz S** setting.
- 5) Under **Node type**, select the check box **This system is a SLAVE node**.
- 6) **Enter the IP address of the MASTER node** (The OpenScape Business is configured as a slave node and the corresponding IP address of the master node (the OpenScape Office S) is entered. The master and multi-gateway are always assigned to the same system, which is OpenScape Business S in the configuration example).

---

**INFO:** Note that this action cannot be undone after clicking **OK & Next!**

---

- 7) The **Registration Status** displays **Status successful** (or a corresponding error message). This completes the wizard.
- 8) Click on **Finish**.

## 20.6.4.7 How to Configure the Basic Installation for Node 3 (Slave)

For integration in an internetwork, the country code and a node ID must be assigned. The internal station numbers must be uniquely configured throughout the network. The entry of the national and local station numbers is important, since this station number is set in the Trk. Grp. 1 ISDN trunk and used as the location number for normalization.

### *Prerequisites*

- You are logged on to the WBM with the **Advanced** profile.

### *Step by Step*

- 1) In the navigation bar, click on **Setup**.
- 2) In the navigation tree, click on **Wizards > Basic Installation**.

- 3) In the **Country Code** field, enter the country code prefix, e.g., 49 for Germany.
- 4) Enter the **Area Code** and **PABX number**.
- 5) Select the **Network Integration** check box.
- 6) In the **Node ID** field for OpenScape Business, enter a node ID that is unique in the internetwork (a "3" for the configuration example).
- 7) Click on **Execute function**. You are taken to the **Central Functions for Stations** window.
- 8) Since all internal station numbers must be unique in a network, the standard station numbers must be deleted. Enable the **Delete all station call numbers** radio button.
- 9) Enable the check box **Delete all station numbers** and click **OK & Next**. You are taken to the **Change preconfigured call and functional numbers** window.

---

**INFO:** The function codes must be unique in the internetwork.  
Duplicate station numbers are not allowed!

---

- 10) Adapt the preconfigured station numbers to the station numbers in the network and click **OK & Next**. You can optionally adapt the station numbers manually via the wizard or import a CSV file with the appropriately prepared station numbers.
- 11) Now configure the ISDN and analog stations.
- 12) Edit the settings for a Meet-Me conference. You must enter a code that is unique in the internetwork.
- 13) Now configure the sending of e-mails.
- 14) Click on **Finish**.

#### 20.6.4.8 How to Configure Networking for Node 3 (Slave)

In the next step, the Network Configuration wizard is used to configure the networking for node 3.

##### **Prerequisites**

- You are logged on to the WBM with the **Advanced** profile.

##### **Step by Step**

- 1) In the navigation bar, click on **Setup**.
- 2) In the navigation tree, click **Wizards > Basic Installation**.
- 3) Click on **Edit** to start the **Networking Configuration** wizard.
- 4) Select the **Network with OSBiz X / S OSBiz S** setting.

- 5) Under **Node type** , select the check box **This system is a SLAVE node**.
- 6) **Enter die IP address of the MASTER node** (The OpenScape Business is configured as a slave node and the corresponding IP address of the master node (the OpenScape Office S) is entered. The master and multi-location are always assigned to the same system, which is OpenScape Business S in the configuration example).

---

**INFO:** Note that this action cannot be undone after clicking **OK & Next!**

---

- 7) The **Registration Status** displays **Status successful** (or a corresponding error message). This completes the wizard.
- 8) Click on **Finish**.

#### 20.6.4.9 How to Verify the Networking Function for the Master

You can verify the status of the network in general and also the individual station numbers.

##### *Prerequisites*

- You are logged on to the WBM with the **Advanced** profile.

##### *Step by Step*

- 1) In the navigation bar, click on **Network**.
- 2) The status bar shows the **Synchronization status** for the network. Green means that there are no networking problems; red indicates problems in the network.
- 3) Selecting the **Domain View** tab in the **Network** window shows all available nodes with the **Node ID, Name, System Type, Server Address, Registration Status** and **Availability Status**.
- 4) Selecting the **Phone Numbers** tab in the **Network** window opens a window with all the relevant details on the following:
  - Call number**
  - DID**
  - Name**
  - Port Type**
  - Nodes**

#### 20.6.4.10 How to Configure a Multi-Gateway for Node 4 (Master)

The setup of the internetwork as a multi-gateway network is performed at the master node.

### Prerequisites

- You are logged into the WBM with the **Expert** profile.

### Step by Step

- In the navigation bar, click on **Setup**.
- In the navigation tree, click on **Wizards > Networking Configuration**.
- Under **Network Configuration**, select the setting **Multi-Location setup**. The assignment of stations to the location is specified in the **Multi-Location setup** window. The assignment of the call numbers to the node ID is used for the outbound trunk seizure in the assigned location nodes, for example.
- Enter the following assignments under **Multi-Location setup** for the configuration example (all telephones are registered at OpenScape Business S):

Phone number	Name	Node ID
1101	1101KN1	1-Slave Witten1
1102	1102KN1	1-Slave Witten1
1103	1103KN1	1-Slave Witten1
2101	2101KN2	2-Slave Munich
2102	2102KN2	2-Slave Munich
2103	2103KN2	2-Slave Munich
3101	3101KN3	3-Slave Witten 2
3102	3102KN3	3-Slave Witten 2
3103	3103KN3	3-Slave Witten 2

- Click on **Finish**.

## 20.6.4.11 How to Configure Routes and Routing Parameters (Node 1, Slave)

In the following steps, you will configure the route and routing parameters for the networking of the slave.

### Prerequisites

- You are logged into the WBM with the **Expert** profile.

### Step by Step

- In the navigation bar, click on **Expert Mode**.
- In the navigation tree, click **Telephony > Trunks/Routing**.
- In the menu tree, click **Route**.

- 4) In the **Change Route** window, enter a name for the CO trunk in the **Route Name** field, e.g., *Route 1*.
- 5) Under **Seizure code**, enter *0*.
- 6) Under **Incoming PABX number**, in the **Country code** field, enter the value *49*.
- 7) Under **Incoming PABX number**, in the **Local area code** field, enter the value *2302*.
- 8) Under **Incoming PABX number**, in the **PABX number** field, enter the value *66758*.
- 9) Select the check box **Incoming PABX number** in the **Location number** field.
- 10) The default settings for the routing parameters (No. and type, outgoing, Call number type) can be used.
- 11) Click on **Apply** followed by **OK**.

#### 20.6.4.12 How to Configure Least Cost Routing (LCR) for the Network (Node 1, Slave)

The default entries in index 32, 33, 34 and 35 in the LCR dial plan must be extended with further entries to enable the dialing of station numbers in the "international, national and station" formats for calls to nodes 2 and 3 and to the multi-gateway node 4. "International" and "National" are always needed. "Local" is only needed for partner nodes that are in the same local network.

##### *Prerequisites*

- You are logged into the WBM with the **Expert** profile.

##### *Step by Step*

- 1) In the navigation bar, click on **Expert Mode**.
- 2) In the navigation tree, click **Telephony > LCR**.
- 3) Click on **Dial Plan** in the menu tree.
- 4) Enter the following values in the free positions after the default values (36 to 43 in this case):

Dial Plan	Name	Dialed digits	Route table
31	Appl-Suite	-171	12
32	Standard	88CZ	1
33	IP Network	-Z	13
34	CO Internat	0C0049-Z	14
36	Node 2 Inter	0C004989722-Z	16
37	Node 2 NAT	0C089722-Z	16
38	Node 3 Inter	0C0049230266719-Z	17



Dial Plan	Name	Dialed digits	Route table
39	Node 3 NAT	0C0230266719-Z	17
40	Node 3 Stn.	0C66719-Z	17
41	Node 4 Inter	0C0049230266758-Z	18
42	Node 4 NAT	0C0230266758-Z	18
43	Node 4 Stn.	0C66758-Z	18
44			-

- 5) Click on **Apply** followed by **OK**.
- 6) In the menu tree, click on the associated **Dial Rule** for node 2.
  - a) Under **Rule Name**, enter the value **Node 2**.
  - b) Under **Dial rule format**, enter the value **D4989722E3A**.
  - c) Select **Corporate Network** as the **Network provider's method of access**.
  - d) Under **Type**, select the item **Country code**.
  - e) Click on **Apply** followed by **OK**.
- 7) Click on **Routing table** in the menu tree to configure routing table 16 for networking and to directly assign it to node 2.
  - a) Click on routing table 16.
  - b) Under **Route**, select the item **Networking**.
  - c) Under **Dial Rule**, select the item **Node 2**.
  - d) Under **min. COS**, select the item **15**.
  - e) Under **Warning**, select the item **None**.
  - f) Under **Dedicated Gateway**, select the item **Forced**.
  - g) Under **GW Node ID**, select the item **2**.
  - h) Click on **Apply** followed by **OK**.
- 8) In the menu tree, click on the associated **Dial Rule** for node 3.
  - a) Under **Rule Name**, enter the value **Node 3**.
  - b) Under **Dial rule format**, enter the value **D49230266719E3A**.
  - c) Select **Corporate Network** as the **Network provider's method of access**.
  - d) Under **Type**, select the item **Country code**.
  - e) Click on **Apply** followed by **OK**.
- 9) Click on **Routing table** in the menu tree to configure routing table 17 for networking and to directly assign it to node 3.
  - a) Click on routing table 17.
  - b) Under **Route**, select the item **Networking**.

- c) Under **Dial Rule**, select the item **Node 3**.
  - d) Under **min. COS**, select the item **15**.
  - e) Under **Warning**, select the item **None**.
  - f) Under **Dedicated Gateway**, select the item **Forced**.
  - g) Under **GW Node ID**, select the item **3**.
  - h) Click on **Apply** followed by **OK**.
- 10) In the menu tree, click on the associated **Dial Rule** for node 4.
- a) Under **Rule Name**, enter the value **Node 4**.
  - b) Under **Dial rule format**, enter the value **D230266758E3A**.
  - c) Select **Corporate Network** as the **Network provider's method of access**.
  - d) Under **Type**, select the item **National**.
  - e) Click on **Apply** followed by **OK**.
- 11) Click on **Routing table** in the menu tree to configure routing table 18 for networking and to directly assign it to node 4.
- a) Click on routing table 18.
  - b) Under **Route**, select the item **Networking**.
  - c) Under **Dial Rule**, select the item **Node 4**.
  - d) Under **min. COS**, select the item **15**.
  - e) Under **Warning**, select the item **None**.
  - f) Click on **Apply** followed by **OK**.

### 20.6.4.13 How to Configure Routes and Routing Parameters (Node 2, Slave)

In the following steps, you will configure the route and routing parameters for the networking of the slave.

#### *Prerequisites*

- You are logged into the WBM with the **Expert** profile.

#### *Step by Step*

- 1) In the navigation bar, click on **Expert Mode**.
- 2) In the navigation tree, click **Telephony > Trunks/Routing**.
- 3) In the menu tree, click **Route**.
- 4) In the **Change Route** window, enter a name for the CO trunk in the **Route Name** field, e.g., *Route 1*.
- 5) Under **Seizure code**, enter 0.

- 6) Under **Incoming PABX number** , in the **Country code** field, enter the value 49.
- 7) Under **Incoming PABX number**, in the **Local area code** field, enter the value 89.
- 8) Under **Incoming PABX number**, in the **PABX number** field, enter the value 722.
- 9) Select the check box **Incoming PABX number** in the **Location number** field.
- 10) The default settings for the routing parameters (No. and type, outgoing, Call number type) can be used.
- 11) Click on **Apply** followed by **OK**.

#### 20.6.4.14 How to Configure Least Cost Routing (LCR) for the Network (Node 2, Slave)

The default entries in index 32, 33, 34 and 35 in the LCR dial plan must be extended with further entries to enable the dialing of station numbers in "international, national and station" formats for calls to nodes 1 and 2. "International" and "National" are always needed. "Local" is only needed for partner nodes that are in the same local network. The entries 36, 37 and 38 for interworking with node 1 (station numbers 100 > 199) and the entries 39, 40 and 41 for interworking with node 3 (station numbers 300 > 399) must be extended. These entries are used for dialing from applications (e.g., myPortal for Desktop).

##### **Prerequisites**

- You are logged into the WBM with the **Expert** profile.

##### **Step by Step**

- 1) In the navigation bar, click on **Expert Mode**.
- 2) In the navigation tree, click **Telephony > LCR**.
- 3) Click on **Dial Plan** in the menu tree.
- 4) Enter the following values in the free positions after the default values (36 to 43 in this case):

Dial Plan	Name	Dialed digits	Route table
31	Appl-Suite	-171	12
32	Standard	88CZ	1
33	IP Network	-Z	13
34	CO Internat	0C0049-Z	14
36	Node 1 Inter	0C0049230266758-Z	16
37	Node 1 NAT	0C0230266758-Z	16
38	Node 3 Inter	0C0049230266719-Z	17
39	Node 3 NAT	0C0230266719-Z	17

Dial Plan	Name	Dialed digits	Route table
40	Node 3 Stn.	0C66719-Z	17
41	Node 4 Inter	0C004989722-Z	18
42	Node 4 NAT	0C089722-Z	18
43	Node 4 Stn.	0C722-Z	18
44			-

- 5) Click on **Apply** followed by **OK**.
- 6) In the menu tree, click on the associated **Dial Rule** for node 1.
  - a) Under **Rule Name**, enter the value **Node 1**.
  - b) Under **Dial rule format**, enter the value **D49230266758E3A**.
  - c) Select **Corporate Network** as the **Network provider's method of access**.
  - d) Under **Type**, select the item **Country code**.
  - e) Click on **Apply** followed by **OK**.
- 7) Click on **Routing table** in the menu tree to configure routing table 16 for networking and to assign it directly to node 1.
  - a) Click on routing table 16.
  - b) Under **Route**, select the item **Networking**.
  - c) Under **Dial Rule**, select the item **Node 1**.
  - d) Under **min. COS**, select the item **15**.
  - e) Under **Warning**, select the item **None**.
  - f) Under **Dedicated Gateway**, select the item **Forced**.
  - g) Under **GW Node ID**, select the item **1**.
  - h) Click on **Apply** followed by **OK**.
- 8) In the menu tree, click on the associated **Dial Rule** for node 3.
  - a) Under **Rule Name**, enter the value **Node 3**.
  - b) Under **Dial rule format**, enter the value **D49230266719E3A**.
  - c) Select **Corporate Network** as the **Network provider's method of access**.
  - d) Under **Type**, select the item **Country code**.
  - e) Click on **Apply** followed by **OK**.
- 9) Click on **Routing table** in the menu tree to configure routing table 17 for networking and to directly assign it to node 3.
  - a) Click on routing table 17.
  - b) Under **Route**, select the item **Networking**.
  - c) Under **Dial Rule**, select the item **Node 3 Direct**.

- d) Under **min. COS**, select the item **15**.
  - e) Under **Warning**, select the item **None**.
  - f) Under **Dedicated Gateway**, select the item **Forced**.
  - g) Under **GW Node ID**, select the item **3**.
  - h) Click on **Apply** followed by **OK**.
- 10) In the menu tree, click on the associated **Dial Rule** for node 4.
- a) Under **Rule Name**, enter the value **Node 4**.
  - b) Under **Dial rule format**, enter the value **D89722E3A**.
  - c) Select **Corporate Network** as the **Network provider's method of access**.
  - d) Under **Type**, select the item **Local area code**.
  - e) Click on **Apply** followed by **OK**.
- 11) Click on **Routing table** in the menu tree to configure routing table 18 for networking and to directly assign it to node 4.
- a) Click on routing table 18.
  - b) Under **Route**, select the item **Networking**.
  - c) Under **Dial Rule**, select the item **Node 4**.
  - d) Under **min. COS**, select the item **15**.
  - e) Under **Warning**, select the item **None**.
  - f) Click on **Apply** followed by **OK**.

#### 20.6.4.15 How to Configure Routes and Routing Parameters (Node 3, Slave)

In the following steps, you will configure the route and routing parameters for the networking of the slave.

##### *Prerequisites*

- You are logged into the WBM with the **Expert** profile.

##### *Step by Step*

- 1) In the navigation bar, click on **Expert Mode**.
- 2) In the navigation tree, click **Telephony > Trunks/Routing**.
- 3) In the menu tree, click **Route**.
- 4) In the **Change Route** window, enter a name for the CO trunk in the **Route Name** field, e.g., `Route 1`.
- 5) Under **Seizure code**, enter 0.
- 6) Under **Incoming PABX number**, in the **Country code** field, enter the value 49.

- 7) Under **Incoming PABX number**, in the **Local area code** field, enter the value 2302.
- 8) Under **Incoming PABX number**, in the **PABX number** field, enter the value 66719.
- 9) Select the check box **Incoming PABX number** in the **Location number** field.
- 10) The default settings for the routing parameters (No. and type, outgoing, Call number type) can be used.
- 11) Click on **Apply** followed by **OK**.

#### 20.6.4.16 How to Configure Least Cost Routing (LCR) for the Network (Node 3, Slave)

The default entries in index 32, 33, 34 and 35 in the LCR dial plan must be extended with further entries to enable the dialing of station numbers in "international, national and station" formats for calls to nodes 1 and 2. "International" and "National" are always needed. "Local" is only needed for partner nodes that are in the same local network. These entries are used for dialing from applications (e.g., myPortal for Desktop).

##### *Prerequisites*

- You are logged into the WBM with the **Expert** profile.

##### *Step by Step*

- 1) In the navigation bar, click on **Expert Mode**.
- 2) In the navigation tree, click **Telephony > LCR**.
- 3) Click on **Dial Plan** in the menu tree.
- 4) Enter the following values:

Dial Plan	Name	Dialed digits	Route table
31	Appl-Suite	-171	12
32	Standard	88CZ	1
33	IP Network	-Z	13
34	CO Internat	0C0049-Z	14
36	Node 1 Inter	0C0049230266758-Z	16
37	Node 1 NAT	0C00230266758-Z	16
38	Node 1 Stn.	0C66758-Z	16
39	Node 2 Inter	0C004989722-Z	17
40	Node 2 NAT	0C0089722-Z	17
41	Node 4 Inter	0C0049230266719-Z	18

Dial Plan	Name	Dialed digits	Route table
42	Node 4 NAT	0C0230266719-Z	18
43	Node 4 Stn.	0C66719-Z	18
44			-

- 5) Click on **Apply** followed by **OK**.
- 6) In the menu tree, click on the associated **Dial Rule** for node 1.
  - a) Under **Rule Name**, enter the value **Node 1**.
  - b) Under **Dial rule format**, enter the value **D49230266758E3A**.
  - c) Select **Corporate Network** as the **Network provider's method of access**.
  - d) Under **Type**, select the item **Country code**.
  - e) Click on **Apply** followed by **OK**.
- 7) Click on **Routing table** in the menu tree to configure routing table 16 for networking and to assign it directly to node 1.
  - a) Click on routing table 16.
  - b) Under **Route**, select the item **Networking**.
  - c) Under **Dial Rule**, select the item **Node 1**.
  - d) Under **min. COS**, select the item **15**.
  - e) Under **Warning**, select the item **None**.
  - f) Under **Dedicated Gateway**, select the item **Forced**.
  - g) Under **GW Node ID**, select the item **1**.
  - h) Click on **Apply** followed by **OK**.
- 8) In the menu tree, click on the associated **Dial Rule** for node 2.
  - a) Under **Rule Name**, enter the value **Node 2**.
  - b) Under **Dial rule format**, enter the value **D4989722E3A**.
  - c) Select **Corporate Network** as the **Network provider's method of access**.
  - d) Under **Type**, select the item **Country code**.
  - e) Click on **Apply** followed by **OK**.
- 9) Click on **Routing table** in the menu tree to configure routing table 17 for networking and to assign it directly to node 2.
  - a) Click on routing table 17.
  - b) Under **Route**, select the item **Networking**.
  - c) Under **Dial Rule**, select the item **Node 2**.
  - d) Under **min. COS**, select the item **15**.
  - e) Under **Warning**, select the item **None**.

- f) Under **Dedicated Gateway**, select the item **Forced**.
  - g) Under **GW Node ID**, select the item **2**.
  - h) Click on **Apply** followed by **OK**.
- 10) In the menu tree, click on the associated **Dial Rule** for node 4.
- a) Under **Rule Name**, enter the value **Node 4**.
  - b) Under **Dial rule format**, enter the value **D230266719E3A**.
  - c) Select **Corporate Network** as the **Network provider's method of access**.
  - d) Under **Type**, select the item **Local area code**
  - e) Click on **Apply** followed by **OK**.
- 11) Click on **Routing table** in the menu tree to configure routing table 18 for networking and to directly assign it to node 4.
- a) Click on routing table 18.
  - b) Under **Route**, select the item **Networking**.
  - c) Under **Dial Rule**, select the item **Node 4**.
  - d) Under **min. COS**, select the item **15**.
  - e) Under **Warning**, select the item **None**.
  - f) Click on **Apply** followed by **OK**.

#### 20.6.4.17 How to Configure Routes and Routing Parameters (Node 4, Master)

In the following steps, you will configure the route and routing parameters for the networking of the slave.

##### *Prerequisites*

- You are logged into the WBM with the **Expert** profile.

##### *Step by Step*

- 1) In the navigation bar, click on **Expert Mode**.
- 2) In the navigation tree, click **Telephony > Trunks/Routing**.
- 3) In the menu tree, click **Route**.
- 4) In the **Change Route** window, enter a name for the CO trunk in the **Route Name** field, e.g., *Route 1*.
- 5) Under **Seizure code**, enter 0.
- 6) Under **Incoming PABX number**, in the **Country code** field, enter the value 49.
- 7) Do not make any entries in the **Local area code** and PABX number fields.
- 8) Select the check box **Incoming PABX number** in the **Location number** field.



- 9) The default settings for the routing parameters (No. and type, outgoing, Call number type) can be used.
- 10) Click on **Apply** followed by **OK**.

### 20.6.4.18 How to Configure Least Cost Routing (LCR) for the Network (Node 4, Master)

The default entries in index 32, 33, 34 and 35 in the LCR dial plan must be extended with further entries to enable the dialing of station numbers in "international, national and station" formats for calls to nodes 1 and 2. "International" and "National" are always needed. "Local" is only needed for partner nodes that are in the same local network. These entries are used for dialing from applications (e.g., myPortal for Desktop).

#### Prerequisites

- You are logged into the WBM with the **Expert** profile.

#### Step by Step

- 1) In the navigation bar, click on **Expert Mode**.
- 2) In the navigation tree, click **Telephony > LCR**.
- 3) Click on **Dial Plan** in the menu tree.
- 4) Enter the following values in the free positions after the default values (36 to 43 in this case):

Dial Plan	Name	Dialed digits	Route table
1	Calling for Help	0C112	19
2	Calling for Help	0C110	19
3	Teleworking	0C0137Z	19
4	Televoting	0C0138Z	19
5	Premium Services	0C0900Z	19
6	Information service	0C118Z	19
7	Special phone number	0C116116	19
16	Standard	0CZ	19
17	Standard	0C1Z	19
18	Standard	0CNZ	19
31	Appl-Suite	-471	12
32	Standard	88CZ	1
33	IP Network	-Z	13
34	CO Internat	0C0049-Z	15
36	Node 1 Inter	0C0049230266758-Z	16
37	Node 1 NAT	0C0230266758-Z	16

Dial Plan	Name	Dialed digits	Route table
38	Node 1 Stn.	0C66758-Z	16
39	Node 2 Inter	0C004989722-Z	17
40	Node 2 NAT	0C089722-Z	17
41	Node 3 Inter	0C0049230266719-Z	18
42	Node 3 NAT	0C0230266719-Z	18
43	Node 3 Stn.	0C66719-Z	18
44			-

- 5) Click on **Apply** followed by **OK**.
- 6) In the menu tree, click on the associated **Dial Rule** for node 1.
  - a) Under **Rule Name**, enter the value **Node 1**.
  - b) Under **Dial rule format**, enter the value **D49230266758E3A**.
  - c) Select **Corporate Network** as the **Network provider's method of access**.
  - d) Under **Type**, select the item **Country code**.
  - e) Click on **Apply** followed by **OK**.
- 7) Click on **Routing table** in the menu tree to configure routing table 16 for networking and to assign it directly to node 1.
  - a) Click on routing table 16.
  - b) Under **Route**, select the item **Networking**.
  - c) Under **Dial Rule**, select the item **Node 1**.
  - d) Under **min. COS**, select the item **15**.
  - e) Under **Warning**, select the item **None**.
  - f) Under **Dedicated Gateway**, select the item **Forced**.
  - g) Under **GW Node ID**, select the item **1**.
  - h) Click on **Apply** followed by **OK**.
- 8) In the menu tree, click on the associated **Dial Rule** for node 2.
  - a) Under **Rule Name**, enter the value **Node 2**.
  - b) Under **Dial rule format**, enter the value **D4989722E3A**.
  - c) Select **Corporate Network** as the **Network provider's method of access**.
  - d) Under **Type**, select the item **Country code**.
  - e) Click on **Apply** followed by **OK**.
- 9) Click on **Routing table** in the menu tree to configure routing table 17 for networking and to assign it directly to node 2.
  - a) Click on routing table 17.

- b) Under **Route**, select the item **Networking**.
  - c) Under **Dial Rule**, select the item **Node 2**.
  - d) Under **min. COS**, select the item **15**.
  - e) Under **Warning**, select the item **None**.
  - f) Under **Dedicated Gateway**, select the item **Forced**.
  - g) Under **GW Node ID**, select the item **2**.
  - h) Click on **Apply** followed by **OK**.
- 10) In the menu tree, click on the associated **Dial Rule** for node 3.
- a) Under **Rule Name**, enter the value **Node 3**.
  - b) Under **Dial rule format**, enter the value **D230266719E3A**.
  - c) Select **Corporate Network** as the **Network provider's method of access**.
  - d) Under **Type**, select the item **Country code**
  - e) Click on **Apply** followed by **OK**.
- 11) Click on **Routing table** in the menu tree to configure routing table 18 for networking and to directly assign it to node 3.
- a) Click on routing table 18.
  - b) Under **Route**, select the item **Networking**.
  - c) Under **Dial Rule**, select the item **Node 3**.
  - d) Under **min. COS**, select the item **15**.
  - e) Under **Warning**, select the item **None**.
  - f) Under **Dedicated Gateway**, select the item **Forced**.
  - g) Under **GW Node ID**, select the item **3**.
  - h) Click on **Apply** followed by **OK**.
- 12) In the menu tree, click on the associated **Dial Rule** for trunk calls. This is the predefined dial rule "Gateway Call".
- a) Under **Rule Name**, enter the value **Gateway Call**.
  - b) Under **Dial rule format**, enter the value **E1A**.
  - c) Select **Corporate Network** as the **Network provider's method of access**.
  - d) Under **Type**, select the item **Unknown**.
  - e) Click on **Apply** followed by **OK**.
- 13) Click on **Routing table** in the menu tree to configure the route table 19 for the breakout of the slave. Using the multi-gateway entry, the association of the subscriber to the node is determined, and the breakout occurs at that node.
- 14) Click on routing table 19.
- a) Under **Route**, select the item **Networking**.

- b) Under **Dial Rule**, select the item **Gateway Call**.
- c) Under **min. COS**, select the item **15**.
- d) Under **Warning**, select the item **None**.
- e) Under **Dedicated Gateway**, select the item **Multi-Gateway**.
- f) Under **GW Node ID**, select the item **1**.
- g) Click on **Apply** followed by **OK**.

## 20.6.5 Networking OpenScape Business in Hosting Environments

In an environment with multiple locations (hosting environment), each site can be assigned a route, and each route can be assigned an ITSP registration. A maximum of 8 ITSP registrations can be managed. One registration per ITSP is possible or even multiple registrations at one ITSP. Each ITSP registration can be assigned an area code, and multiple subscribers can then be assigned to it. The connection between the subscribers at the different sites and the communication system occurs via a VPN or MPLS. If the sites are located in different countries, a separate OpenScape Business S must be used for each country (Scenario 1a). If all sites are located within one country, a single OpenScape Business S can be used (Scenario 1b).

Both scenarios can also be implemented with the OpenScape Business X hardware models (e.g., for smaller configurations). The TDM components can be additionally used at one site.

The following hosting scenarios are described here in general. The following variations can be implemented:

- Use of OpenScape Business S and OpenScape Business X in the Data Center of the customer or at the hoster
- OpenScape Business S on dedicated server hardware or virtualized
- This requires a VPN or MPLS infrastructure, especially for multiple customer sites (no site-specific NAT router for Internet access)
- Up to 8 ITSP per system and country, MSN or DID provider
- Up to 8 site area codes per system and country, assigned to up to 8 customer sites (multi-site)
- Multi-site scenarios combined with classic networking (Voice and UC)
- Multi-site with more than 8 locations feasible in networks (multi-site networked n times)
- Transnational multi-site (multi-site networked n times) feasible in networks
- Networking scenarios with ISDN gateways fully integratable
- The technical prerequisite is the ability to use DID phone numbers for both ISDN providers as well as SIP providers.

### Scenario a: Hosting with an OpenScape Business S per Site

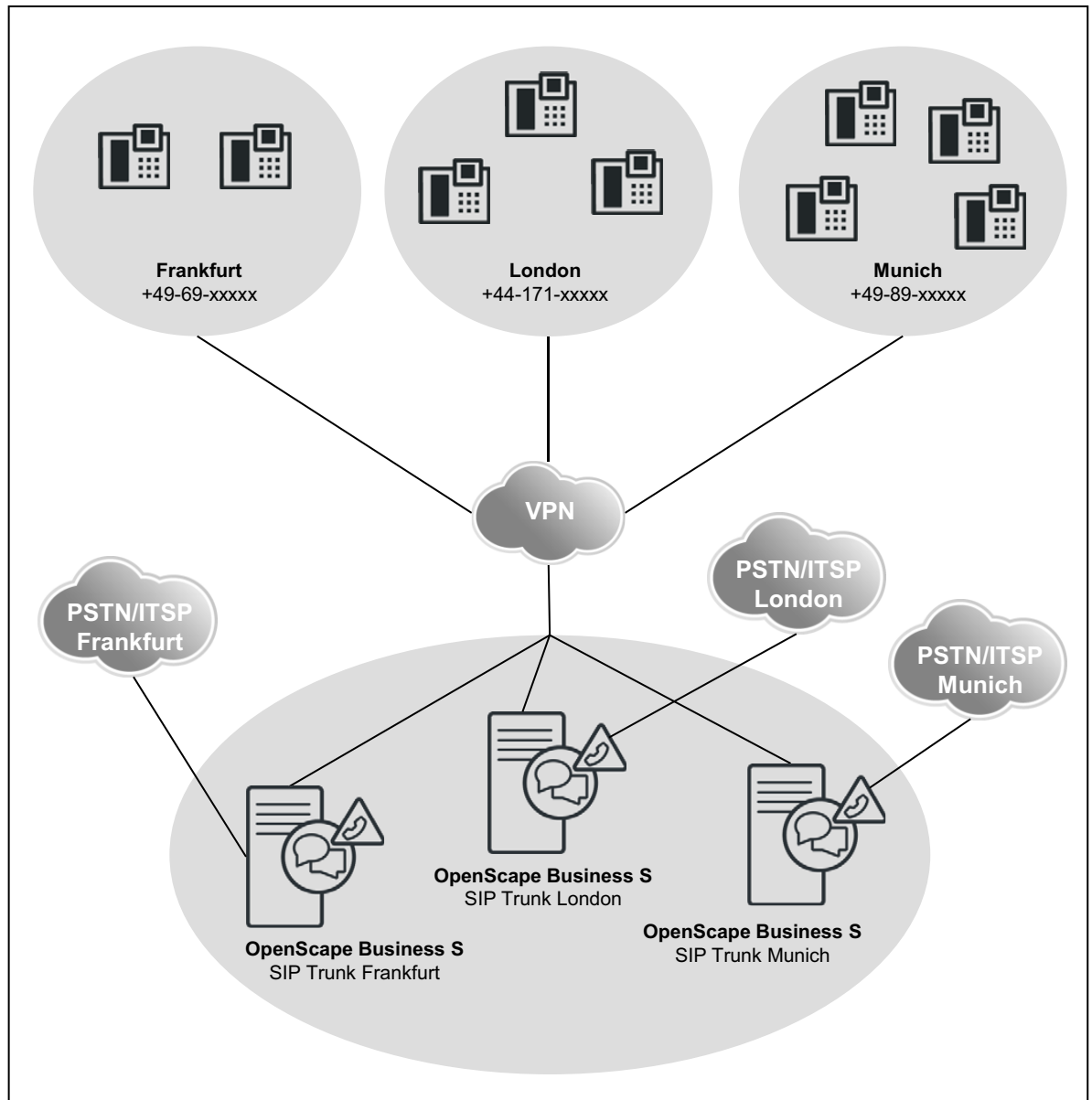

#### Network Data

- A customer within a VPN or MPLS.
- One OpenScape Business S per site.
- The sites may be distributed within a country or across multiple countries.
- Up to 1000 users and 180 SIP trunks per OpenScape Business S.
- OpenScape Business networking is optional, up to a total of 1500 users. Larger configurations are possible within the framework of project-specific releases.

### Scenario b: Hosting with OpenScape Business S for Multiple Sites

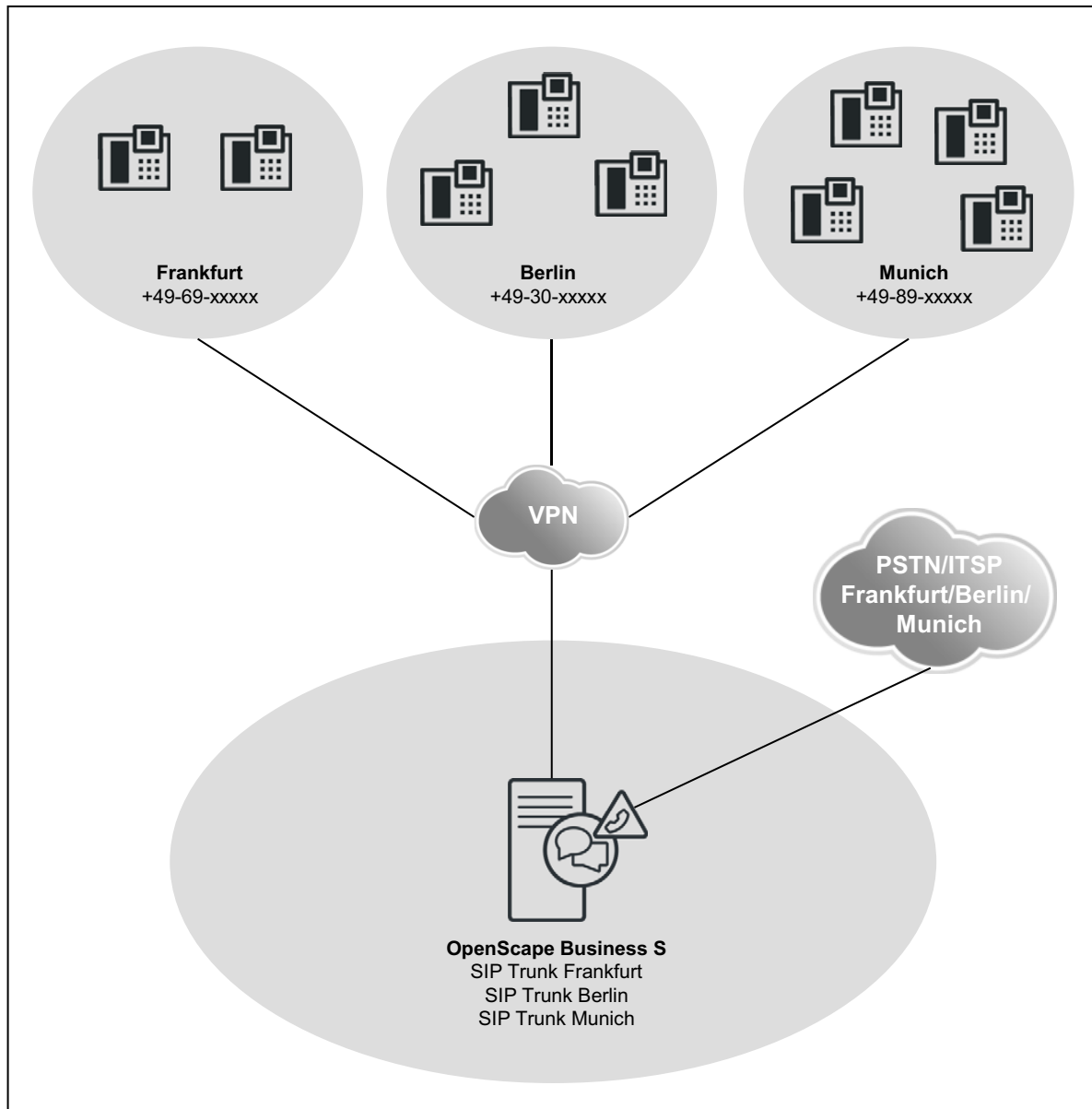

#### Network Data

- A customer within a VPN or MPLS.
- One OpenScape Business S for all sites.
- All sites located within only one country.
- Up to 8 sites with different site prefixes
- Up to 8 SIP providers per OpenScape Business S.
- One SIP provider per site.
- Up to 1000 users and 180 SIP trunks.

- OpenScape Business networking with multiple OpenScape Business S within a VPN is optional (OS Biz S 1 in country 1, OS Biz S 2 in country 2, etc.), up to a total of 1500 users. Larger configurations are possible within the framework of project-specific releases.
- A configuration example can be found at the Unify Experts wiki on the Internet under *ITSP Configuration Guide*,

## 20.6.6 Networking OpenScape Business X and OpenScape Voice

OpenScape Business X can be networked with OpenScape Voice.

---

**INFO:** A configuration example for networking with OpenScape Voice can be found in the Unify Experts wiki at [http://wiki.unify.com/wiki/How\\_to\\_collection\\_and\\_tutorials\\_for\\_OpenScape\\_Business](http://wiki.unify.com/wiki/How_to_collection_and_tutorials_for_OpenScape_Business)

---

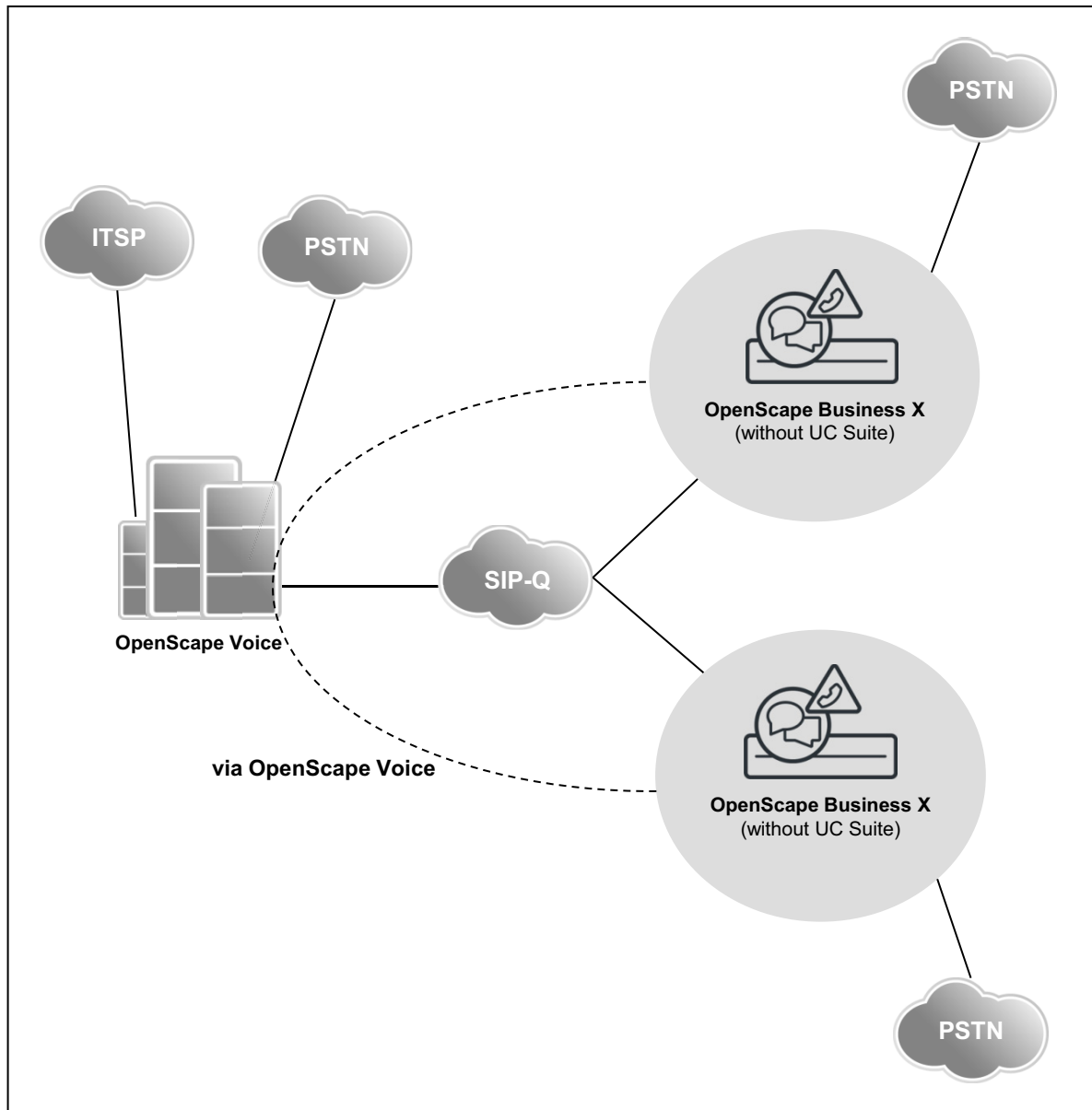

### Network Data

- OpenScape Business X provides network-wide voice and gateway functionality for OpenScape Voice.
- One or more OpenScape Business X systems can be used as a gateway for digital Central Offices (ISDN, T1, CAS)
- The following devices can be operated at OpenScape Business X gateways: digital / analog / DECT / IP (HFA)
- UC is generally not supported by OpenScape Business X in this networking scenario.
- Each call from one node to another is routed through OpenScape Voice.
- The configuration of each node occurs in Expert mode.



- The OpenScape Voice dial plan is based on E.164, which explains why neither open nor closed numbering is available.

### Network-wide Features

Maximum configuration	
Maximum number of nodes	Depending on OpenScape Voice
Maximum number of stations in a single communication system	Depending on OpenScape Business X
Maximum number of stations in the network	Depending on OpenScape Voice

Administration	
WBM	The Networking wizard cannot be used. OpenScape Voice is administered per node via the OpenScape Business expert mode.
Manager E	Not recommended
UC Administration	UC is not relevant in connection with OpenScape Voice
Mass data import via CSV files (call numbers, DID numbers, names)	Separately for each of the nodes in the OpenScape Business internetwork

Licensing	
Licensing structure	Each node individually; a network license is required for each OpenScape Business node

### Restrictions and Notes on the Features

- The connection of analog CO trunks at OpenScape Business gateways is released **only** for Brazil (due to the support for line reversal and backward release of analog CO trunks in Brazilian COs).
- A network of OpenScape Business gateways with one another or with systems other than OpenScape Voice is not supported. The networking of the OpenScape Business gateways with OpenScape Voice must occur through a star-shaped network structure.
- Path replacement (route optimization) via SIP-Q is not supported for the devices connected to an OpenScape Business gateway.
- To avoid poor voice quality on transit line connections, the G.711 voice codec should be used. The G.729 codec is not recommended, since transit line connections can be caused by features such as conferencing and call forwarding. This is because path replacement (i.e., route optimization) is not supported.
- No cross-system support between OpenScape Voice and OpenScape Business gateways is available for features such as call pickup groups, group calls and hunt groups. The groups may include only subscribers of either OpenScape Voice or OpenScape Business, but not both.
- Encryption (SPE) between OpenScape Voice and OpenScape Business gateways is supported. The connection between OpenScape Voice and OpenScape Business must be made by means of the TLS encryption

protocol. SRTP (SDES) is not supported in a network with OpenScape Voice V7R1.

- Networking is supported only with the E.164 numbering plan.
- The following applies to the IP stations (HFA) connected to OpenScape Business gateways: For each active OpenScape Business/OpenScape Voice connection, two B channels per HFA device are required (one B channel per TDM device). The need for these additional DSP resources should be reviewed and taken into consideration.

## **20.6.7 Connecting External Auxiliary Equipment to OpenScape Business via SIP Interconnection**

External auxiliary equipment can be connected to OpenScape Business via SIP Interconnection, e.g., to use applications such as OpenScape Alarm Server, OpenScape 4000, OpenScape Voice or other certified SIP servers.

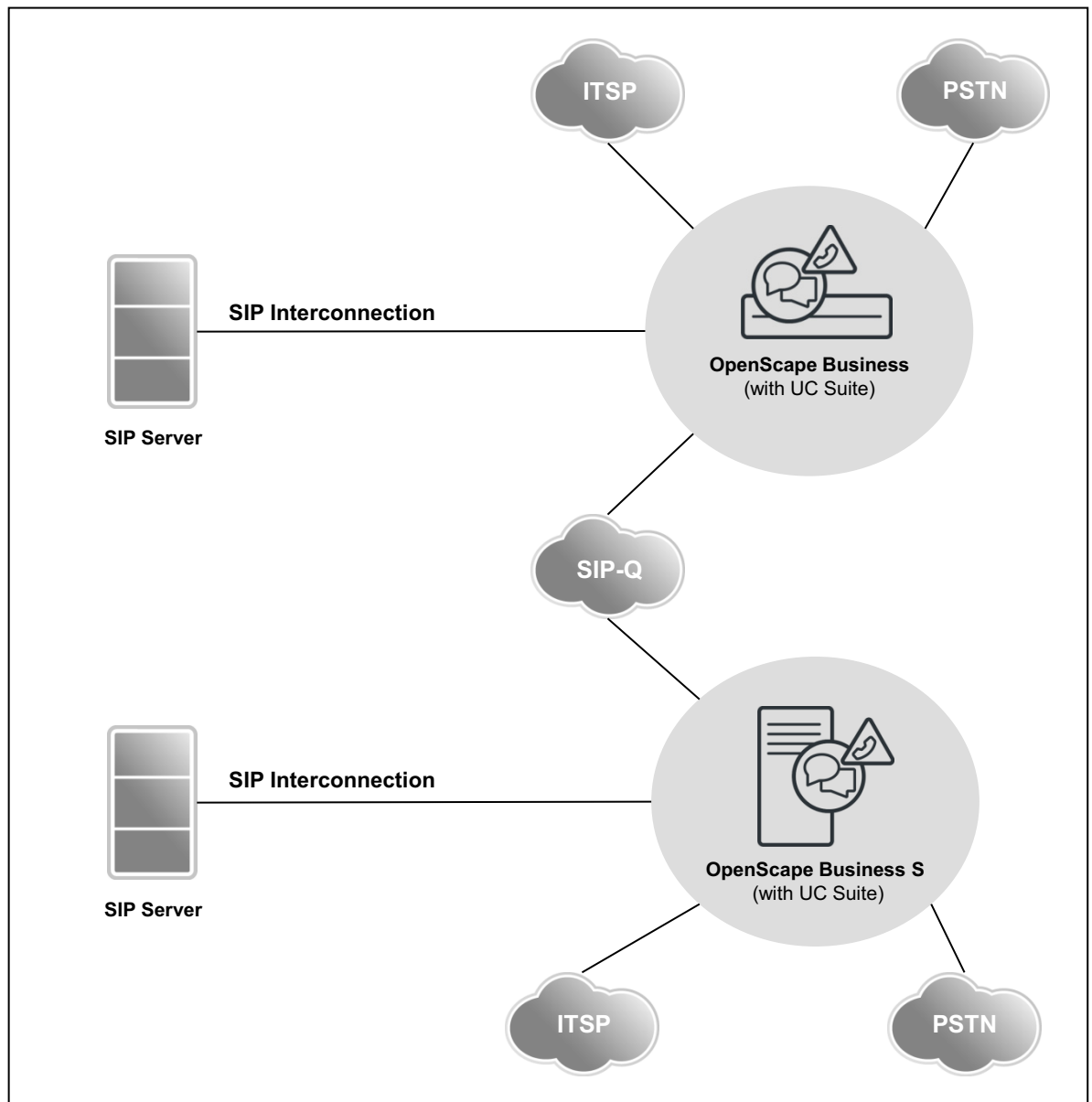

### Prerequisites

- Only certified applications may be connected, for example, OSCAR.
- An external SIP server can be connected via the Native SIP or SIP-Q protocol.
- A maximum of two SIP-Q routes (one is required for UC Suite, if present) and a maximum of 10 Native SIP routes (of which up to 8 Native SIP routes can be used for ITSP) are available.

### Additional information can be found in the

- Expert wiki for telephones, communication systems and UC:  
<http://wiki.unify.com>

## 20.6.8 Open Numbering in OpenScape Business X Networks

A internetwork with open numbering can be set up by networking two (or more) communication systems whose numbering schemes overlap one another (i.e., not unique throughout the internetwork).

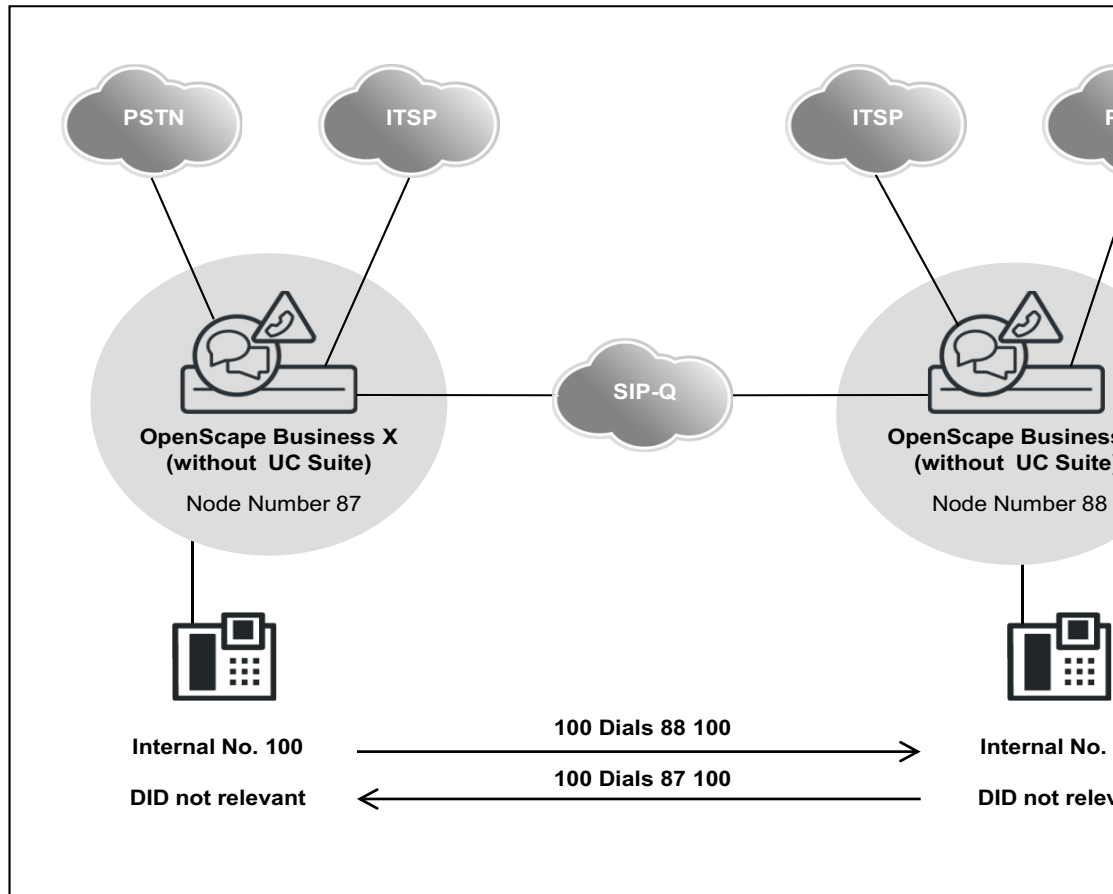

### Network Data

- Network-wide voice networking via OpenScape Business.
- UC features are not supported.
- Every call within a node occurs with an internal call number.
- Every call to another node occurs with a node number (plus an internal number).
- Each node must be configured in Expert mode. The Networking wizard is disabled once a node number for open numbering has been configured.
- Outside line access to the PSTN or ITSP is possible from each node.

**INFO:** In case of a network-wide extension on UC functionality, it is necessary to change from open to closed numbering in order to adapt the internal numbers. Thus, the open numbering must be disabled, while the node number must be deleted and

subsequently added as a prefix (for example, extended internal number 87100 instead of 100 and 88100 instead of 100).

Differences:

- The selection of participants in their own node is made with the extended internal number.
- The internal number and the DID number may differ if necessary, but the DID numbers must not be changed.

## 20.6.8.1 How to Configure Open Numbering

### Configuring Open Numbering

1. Use the **Open numbering** system flag to enable open numbering for the communication system
2. Enter the number of your own node (e.g., "87")

### Configuring Nodes (Routing)

1. The destination nodes are addressed via Voice Gateway > Networking > Nodes > Routing (e.g., "88")
2. In an open numbering scheme, the **Networking** wizard cannot be used; this is prevented by the **Open numbering** system flag.

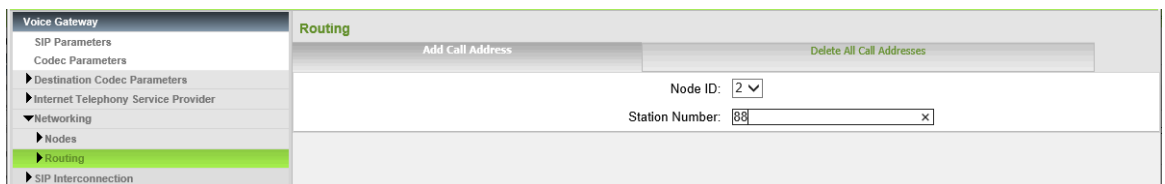

### Configure LCR

1. Assign the "Node 2 open Num" dial rule to the node number and select the associated routing table.

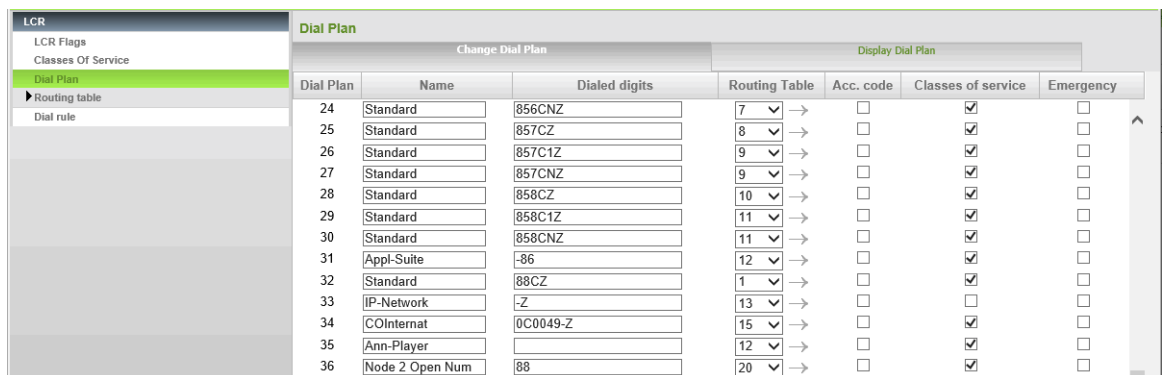

2. Display the configured route

Index	Route	Dial Rule	min. COS	Warning	Dedicated Gateway	GW Node ID
1	Networking	Node 2 Open Num	15	None	No	
2	None	None	15	None	No	
3	None	None	15	None	No	
4	None	None	15	None	No	
5	None	None	15	None	No	
6	None	None	15	None	No	
7	None	None	15	None	No	
8	None	None	15	None	No	
9	None	None	15	None	No	
10	None	None	15	None	No	
11	None	None	15	None	No	
12	None	None	15	None	No	
13	None	None	15	None	No	
14	None	None	15	None	No	
15	None	None	15	None	No	
16	None	None	15	None	No	

- Enter the name of the "Networking" route and the dial rule "Node 2 open Num" associated with it.

	Rule Name	Dial rule format	Network access	Type
1	ISDN	A	Main network supplie	Unknown
2	SIP	A	Main network supplie	Unknown
3	SIP lokal	D089E2A	Main network supplie	Unknown
4	MEB	E1A	Corporate Network	PABX number
5	IP-Network	A	Corporate Network	Unknown
6	Multi-Location	BA	Corporate Network	Unknown
7	Gateway call	E1A	Corporate Network	Unknown
8	COInternat	D0E3A	Main network supplie	Unknown
9	Node 2 Open Num	E1A	Unknown	Unknown

## 20.6.9 Networking via ISDN

OpenScape Business systems can be networked with one another as well as with HiPath 3000 and OpenScape 4000 communication systems via digital trunks. Both  $S_0$  as well as  $S_{2M}$  lines can be used for the connection.

## Networking with HiPath 3000

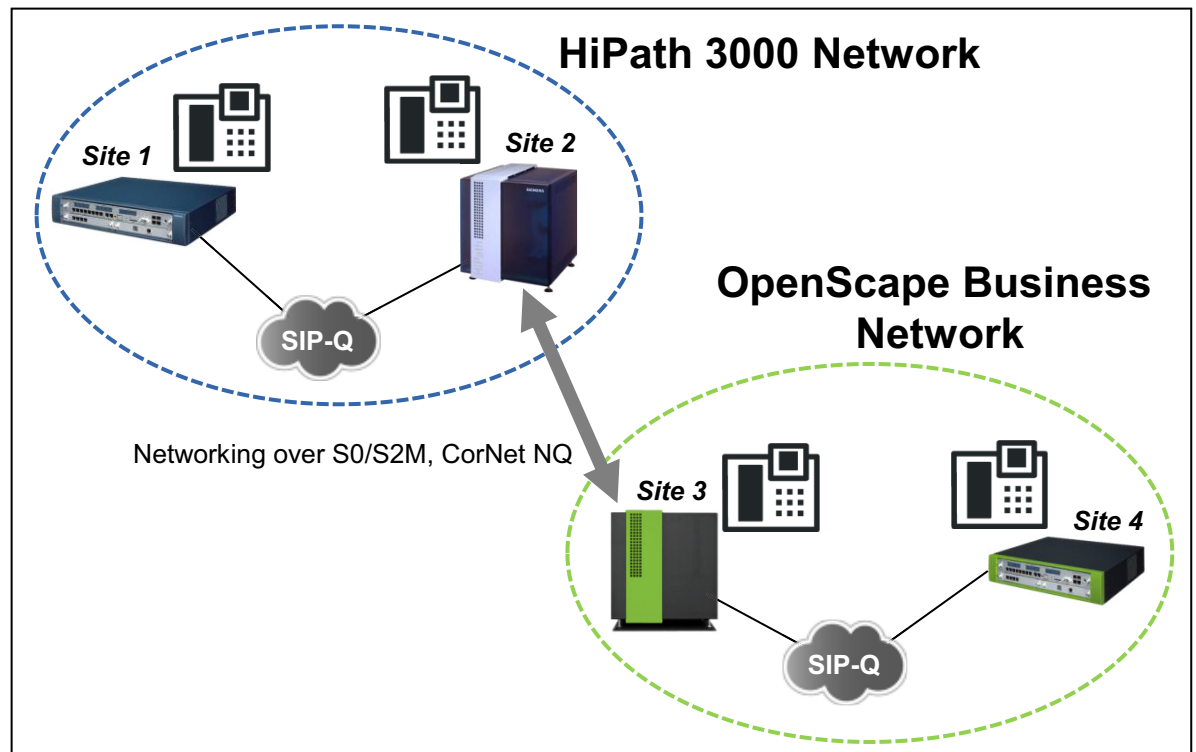

The existing HiPath 3000 network is (initially) left intact. The expansion of the network occurs with OpenScape Business. HiPath 3000 nodes can be gradually migrated into the OpenScape Business network as required.

Every cross-network call that traverses the HiPath 3000/OpenScape Business is conducted via suitable TDM gateways ( $S_0$  or  $S_{2M}$  with CorNet NQ protocol, possibly QSIG as a vendor-independent protocol).

The following constraints apply:

- Separate licensing for HiPath 3000 / OpenScape Business
- Separate administration for HiPath 3000 / OpenScape Business
- Recommendation: closed numbering in the overall network. Open numbering could potentially result in erratic behavior with CLIP and for journal entries / caller lists.
- Recommendation: use only the G.711 codec to ensure good voice quality in the overall network.
- The number of B-channels must be determined by taking the expected call volume into account.
- OpenScape Business requires a Networking license in any case.

### Connection of External Systems via QSIG

The following must be noted when connecting external systems with the QSIG protocol:

- Check the QSIG variants of the external systems involved for compatibility (QSIG V1, also called QSIG as per the ECMA Standard, and QSIG V2, also called QSIG as per the ISO Standard)
- Compare the feature sets of the relevant systems. This should help to determine to what extent the theoretically expected scope of functionality, i.e., the intersection of both feature sets, corresponds to the customer's wishes.
- Furthermore, to guarantee the expected functionality, an on-site test of the connection is recommended. In particular, interworking with other networking and PBX protocols must be taken into account.

### **20.6.10 OpenScape Business internetwork with central ITSP trunk connection**

A pure OpenScape Business internetwork can be implemented with a central DID-capable ITSP trunk connection instead of ISDN.



### Networking with Central DID-capable ITSP Trunk connection

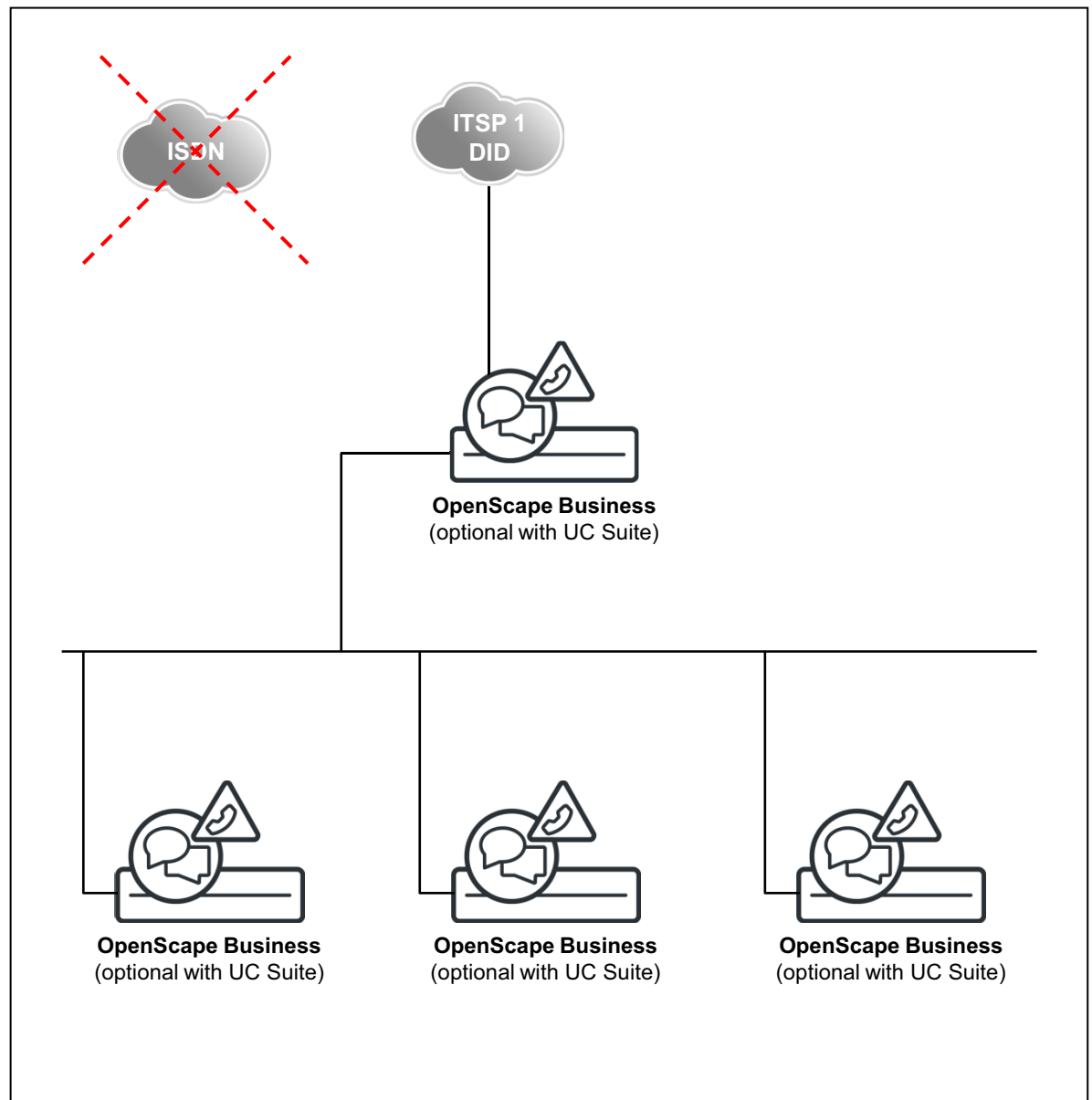

The following must be observed when planning customer networks:

- **One** central ITSP trunk connection for the entire OpenScape Business network.
- Registration at exactly one local network, i.e., all nodes in the network use exactly one Central Office number, e.g., 0049 89 7007-XXXXX.
- For emergency calls, the networked nodes can use their own trunk connections for outbound calls in cases where the central ITSP access fails. Under certain circumstances, a correct caller identification to the outside may not be possible in this case. Emergency calls, for example, may not be delivered correctly. Incoming accessibility via this local connection is also

subject to restrictions. For these reasons, local connections are not recommended, though not prevented technically.

- For the same reason, additional ISDN connections are not recommended (though technically not prevented) at the central node.
- All digit analysis and call routing rules for standalone OpenScape Business systems and networks apply. The station number assignment of the ITSP CO numbers occurs exclusively via the DID configuration of the station in this case (and not via the mapping table; see Configuring an ITSP in section 9.2 and the Unify Experts wiki on the Internet).

## 20.7 Central Intercept Position in the Internetwork (Not for U.S.)

OpenScape Business allows incoming calls that cannot be assigned to a station or answered to be diverted to a defined intercept position in the internetwork to ensure that no calls are lost.

If the central intercept position in the internetwork is configured using ISDN, then the functionality is identical to the functionality without networking.

In conjunction with an ITSP Central Office, the central intercept position is subject to some restrictions, since every node essentially has its own ITSP:

- The ITSP intercept criteria apply only to each respective node.
- The intercepts "on RNA", "on Device Busy", "on Incomplete", "on Invalid", and "on Unanswered Recall" work.
- The intercept types "on Invalid" and "on Incomplete" do not work with the ITSP.
- Incomplete or invalid telephone numbers are returned to the ITSP with a busy signal.

If a central intercept position is to be used in an internetwork, virtual stations must be configured in each node. These virtual stations are permanently diverted via the internetwork to the myAttendant user.

Example for an ITSP CO: ITSP PABX number is 0211-23456789 + ITSP DID number; the number 0211-23456789-0 is publicly announced as the central number of the communication system.

- Station 100 is myAttendant with its own ITSP DID number 100 and a virtual station 199 with the ITSP DID number "0".
- In the ITSP mapping list of each node, the ITSP DID number "0" is assigned to the own virtual station.
- Under **Incoming Calls/Call Forwarding**, the virtual stations are referred to station 100.

First destination: own virtual station

Second destination: station 100 in the destination node

Call time 5 seconds

For better identification of calls, it is recommended that the virtual stations of all nodes be provided with their call number (DID) and a name (e.g., company) via the myAttendant application (under **Setup/myAttendant/DIDs**). This enables a

more detailed identification of the caller in the **Active Calls** window of myAttendant.

## 20.7.1 How to Configure a Central Intercept Position in the Multi-Gateway Internetwork

This configuration example shows you how to set up a central intercept position in the multi-gateway internetwork via the upstream OpenScape Business gateways. All calls which are received at a node and which meet the intercept criteria must be routed to OpenScape Business S, where the central AutoAttendant is located.

### Prerequisites

- OpenScape Business S is the master (all HFA and SIP stations are logged in here).
- Multiple OpenScape BusinessX systems have been set up as slave nodes (with PSTN or ITSP as the outside line). The nodes may be at the same location or at different locations (with different prefixes).

### Step by Step

- 1) Set up a virtual station at the OpenScape Business.
  - a) Set up a virtual station with the name "Intercept 22 System2"
- 2) Set up a central intercept position with intercept criteria at the OpenScape Business.
  - a) **Expert mode**
  - b) **Basic Setup > System > Intercept/Attendant/Hotline**
  - c) Select virtual station 22 under **Intercept position** for **Day and night**.
  - d) Enter the following parameters for station 22 under **Intercept position** for **Intercept**:

Name	Intercept 22 System2
Direct inward dialing	xxxxxxx22
Device type	Virtual

- e) Activate the entered parameters under **Intercept position** for **Intercept**.
  - f) Set up the virtual station under **Intercept position** for **Lock Code**.
- 3) Set up the call forwarding OpenScape Business.
    - a) Set up the call forwarding of the virtual station 22 via the internetwork to OpenScape Business S.
    - b) **Expert mode**
    - c) **Incoming Calls > Call Forwarding**

**Networking OpenScape Business**

Central Intercept Position in the Internetwork (Not for U.S.)

- d) Select virtual station 22
  - e) Proceed with **Edit Call Forwarding**
  - f) Then go to: **External destination** (enter the station numbers for the AutoAttendant queues, e.g., 7410)
  - g) **Route** = Select network (the AutoAttendant queue station number 7410 must be specifically routed in the LCR by bypassing the -Z default rule 33).
- 4) Configure the routes for OpenScape Business.

The AutoAttendant queue station number 7410 must be specifically routed in the LCR by bypassing the -Z default rule 33.

Under <b>Dial Plan</b> :	Configure the <b>Name</b> (VSL Queue Pilot)
	Enter the station number (7410) under <b>Dialed digits</b>
	Select <b>Routing Table</b> (XX)
Under <b>Routing Table</b> XX:	Select <b>Route</b> = Network
	<b>Assign Dial Rule</b>
	Under <b>Dedicated Gateway</b> , select the entry <b>Mandatory</b>
	Enter the <b>GW Node ID</b> of the OpenScape Business S.
Under <b>Dial Rule</b> :	Enter the <b>Rule Name</b>
	Under <b>Dial rule format</b> , enter D7410 (Queue Pilot Number)
	Under <b>Network provider's method of access</b> , select Corporate Network
	<b>Type</b> : Select Unknown

- 5) Set up a queue at OpenScape Business S.
- a) Set up a queue (Queue Pilot) with a CCV, e.g., **Dial By Extension, Dial By Name, Process after digits.**
- 6) Set up call forwarding at OpenScape Business S.
- a) Set up call forwarding of the Queue Pilot 7410 in OpenScape Business S.
  - b) **Expert mode**
  - c) **Incoming Calls > Call Forwarding**
  - d) Select Queue Pilot 7410
  - e) Proceed with **Edit Call Forwarding**
  - f) First go to: **External destination** (enter the station numbers for the AutoAttendant queues, e.g., 7410)
  - g) Then go to: select the **Voicemail box**

## 20.8 Presence Manager

Presence Manager enables the subscriber states "Free", "Busy" and "Ring" to be signaled throughout the network at the LEDs of the HFA telephones. This requires closed numbering and at least one UC Booster Server at the master node of the internetwork or an OpenScape Business S as the master node. A network license is required for each node.

In the idle state, the corresponding LED is off; in the busy state, it is constantly on, and in the ringing state, the LED flashes. In the ringing state, the call involved can be picked by pressing the corresponding button.

Call processing states can only be signaled for a station if the Presence Manager can set a CSTA monitor point on the relevant station.

The keys are configured by the user. When station numbers are programmed on the telephone itself, no distinction is drawn between internal and network-wide numbers.

The Presence Manager is a service and has no user interface. No settings need be made, as all data is automatically obtained through data synchronization.

Groups are not supported by Presence Manager. LED signaling is not performed and call pickup is not possible. MULAPs, however, are not supported by Presence Manager.

Presence Manager does not actively support any SIP and S<sub>0</sub> phones.

## 20.9 Synchronization Status in the Internetwork

In an internetwork, the synchronization status is displayed in the Admin Portal, and the registration status of each node is indicated by colored buttons. The display of the synchronization status applies to network nodes of the communication system, but not to OpenScape 4000 and OpenScape Voice nodes.

### Display of the Synchronization Status

Display	Color	Meaning for the master	Meaning for the slave
Synchronization status (display on the home page of the Admin Portal)	Red	-	The IP address of the master node is configured, but the slave system could not register. The slave tries to register with the master at cyclical intervals.
	Yellow	-	The slave is registered with the master, but the call numbers are not consistent in the internetwork. This may occur after a backup/restore or after the first registration.
	Green	If a node is configured as the master, the status appears as green.	

Display	Color	Meaning for the master	Meaning for the slave
Registration status of the individual nodes (displayed in the Network>Node View dialog)	Red	The slave is configured, but the system has never registered.	The slave is configured, but the system has never registered.
	Green	The system is registered.	The system is registered.
Alive (displayed in the dialog Network>Node View)	Red	Node-specific view of the internetwork: all nodes that are marked in red cannot be reached. The reasons may be network problems or a failure in the communication system.	
	Green	The (external) node can be reached via the network. The own node is always shown in green.	

## 20.9.1 Manual Synchronization in the Internetwork

If the automatic synchronization of the configured call numbers and names (internal or DID numbers) has not been completed in the other systems of an internetwork, a manual synchronization can be initiated. This manual synchronization in the internetwork only works in homogeneous networks.

The synchronization process only transfers changes in the configuration.

If the status indicator in the Admin Portal appears as "red", the Synchronization button can be pressed to try and manually synchronize the data with the master.

In cases where already configured systems in the network can no longer make calls, the potential cause for the problem must be found elsewhere. If the Alive status of individual nodes appears as "red", this indicates network problems or other reasons why the node cannot be reached in the network. In such cases, activating the Synchronization button will not improve the situation.

### Master

When activated on the master node, the slave nodes are requested to update the phone numbers and names of the system from the master.

### Slave

When activated on a slave node, the station numbers and names of the system are updated on the master. At the same time, the slave node is registered again at the master node.

## 20.9.2 How to Start Synchronization Manually

### Prerequisites

- You are logged on to the WBM with the **Advanced** profile.

### *Step by Step*

- 1) Click on **Service Center** in the navigation bar.
- 2) Click **Restart / Reload** in the navigation tree.
- 3) Activate the **Sync Network** button to start the manual synchronization.

## 20.10 Survivability

Survivability is a feature within a network of OpenScape Business S systems with OpenScape Business X gateways. If the OpenScape Business S fails or cannot be reached due to network errors, the system telephones (HFA) logged in at the OpenScape Business S can log in at an OpenScape Business X Gateway (standby gateway) instead. The phone numbers of the system telephones are retained after the new login. This provides continuity for basic telephony; however, the features of applications such as myPortal, voicemail and CTI will be temporarily unavailable.

After the OpenScape Business S can be securely accessed again, the system telephones automatically revert to the OpenScape Business S.

The time for switching to the standby gateway can last up to 30 minutes.

If the OpenScape Business S fails, an attempt is first made to reach it again for a fixed time period (10 minutes; cannot be changed). It is only when this time has expired that the system telephones intended for this purpose are registered at the standby gateway. The current statuses of the registered phones can be viewed in **Expert Mode > Diagnosis Logs**.

The survivability settings are configured at the system telephones. If the OpenScape Business S fails, the phones will initially try to reach it again several times. A time-out or how often the phone tries to log in again can be configured via the "System Redundancy" setting on the Administration menu of the telephones. The default setting for the timeout is 30 seconds with one retry. After that, the telephones register at the standby gateway. The automatic registration back at the OpenScape Business S must also be configured at the system telephones.

The following prerequisites must be satisfied for survivability:

- A sufficient number of free IP ports must be available at the standby gateway for the system phones connected to the OpenScape Business S that need to be "saved" when a network node fails.
- For these free ports on the standby gateway, stations must be set up without a name and phone number.

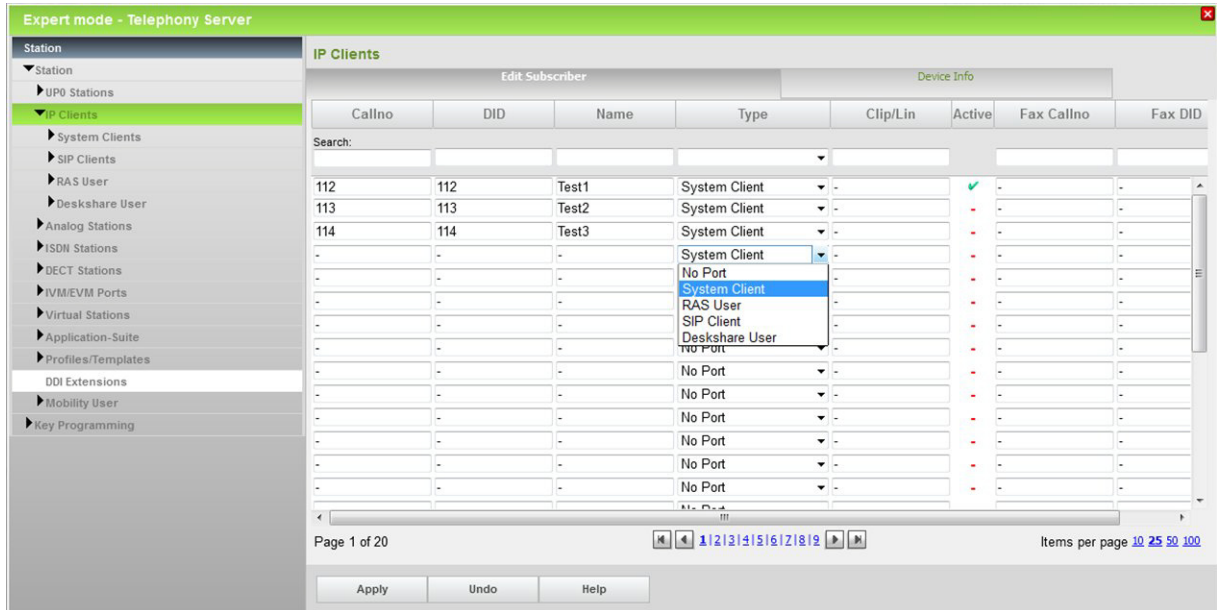

- The stations must be configured as system phones (system clients) and have an IP user license. In the event of survivability, the stations can only use telephony features.

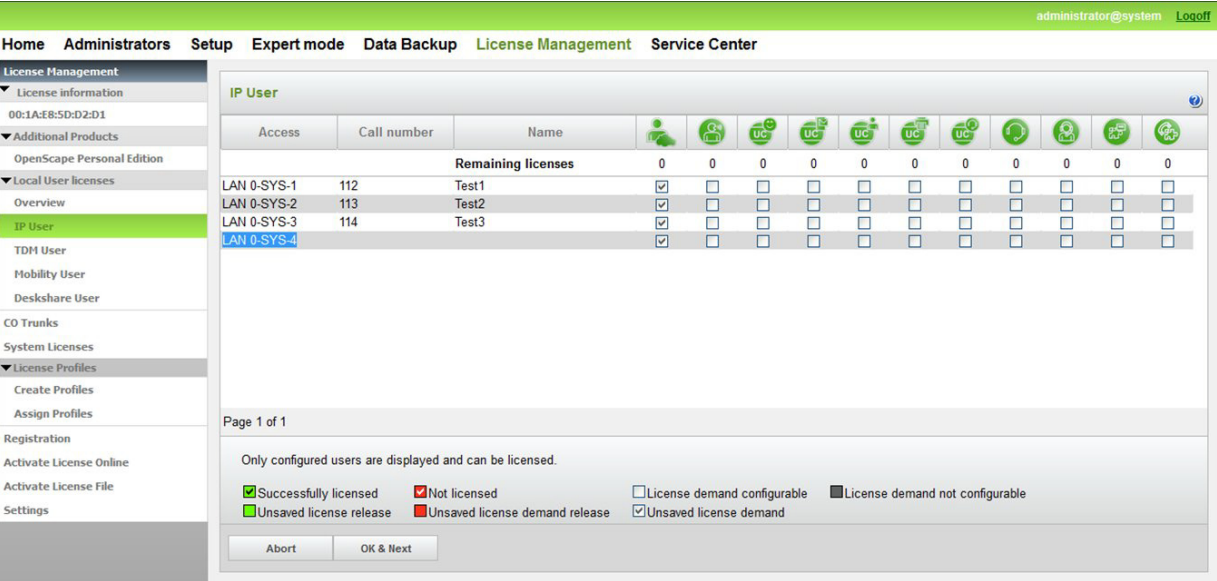

### 20.10.1 How to Configure Survivability

**Prerequisites**

- You are logged into the WBM with the **Expert** profile.



### Step by Step

- 1) In the navigation bar, click on **Expert Mode**.
- 2) Navigate in the menu tree to **Stations > IP Clients**. In the case of an OpenScape Business master system, the **Secondary Gateway** window appears.
- 3) Under **Node ID**, select the OpenScape Business to which OpenScape Business S users are to be transferred in the event of an emergency.
- 4) Select the **Emergency** check box for the emergency station.
- 5) The entries for **Emergency Call no** and **Call no DID** are preset and can be adapted if required.
- 6) Click on **Apply** followed by **OK**.

## 20.11 Removing a Node from the Internetwork

If a node is to be removed from the internetwork, it must first be ensured that the node is no longer available in the network configuration. Otherwise, the node will independently attempt to register itself again in the network and master node will try to synchronize data.

### Procedure

The deletion of a node occurs via the Networking wizard, where all nodes involved must always be removed.

- Interrupt all paths (routing) to the nodes to be removed
- Administration of the internetwork
- Enter "No network" for the slave node involved in the networking wizard of the slave node.
- Remove the slave node from the registration list in the networking wizard of the master node.

If a node is not removed properly, data will continue to be transferred from one OpenScape Business to another and thus produce inconsistencies in the internal directory, i.e., the users will not appear in the user directory and will therefore be unable to use myPortal for Desktop.

## 21 Auxiliary Equipment

Auxiliary equipment consists of external devices (such as an announcement device or an entrance telephone with door opener) that are connected to the interfaces of the communication system. Using an IP-enabled camera, the video surveillance solution Gate View can be deployed.

### 21.1 Analog Announcement Device

An analog announcement device can be connected to an a/b interface to play custom announcements (e.g., for the central AutoAttendant or as a replacement for music on hold).

---

**INFO:** Before using announcements or music from other sources, make sure that you do not infringe on any copyrights.

---

Up to 16 announcement sources (e.g., media servers, announcement players or analog announcement devices) can be configured for each communication system.

The following types of announcement devices can be used:

- Announcement devices that always start at the beginning of the message when activated (such as greeting messages).
- Continuous playback devices (e.g., for music on hold)

The announcement device must behave like a station, i.e., announce itself, play the announcement and switch the call (enter consultation hold, dial and hang up).

#### Announcements Types

The following types of announcement are available:

- Greeting announcement (announcement prior to answer)  
A greeting announcement can be played to callers prior to answering their calls.
- AutoAttendant  
When the AutoAttendant is enabled, music and/or further announcements can be played to callers if they cannot be switched immediately.
- DTMF DID  
When DTMF direct inward dialing is enabled, an announcement lets callers know that they can use DID to dial another extension. During the announcement, a code receiver detects if the caller uses suffix dialing and then forwards the call to the number dialed.

#### Alternatives to the A/B Interface (SLA Boards)

- OpenScape Business X8: TMEW2 board
- OpenScape Business X5: Optional STRB Board

- OpenScape Business X3: Optional STRBR Board

### Announcement Delay Time

The announcement delay time is the time (0 - 600 s, configurable) which must elapse before a waiting call is forwarded to an announcement device.

### Announcement Device - Genius

The TMEW2 board may be installed on interface type 2 for connecting the Genius announcement device. A description of the TMEW2 board and the assignment of SIVAPAC connectors on the backplane when connecting the Genius announcement device can be found in the Service Documentation, Hardware Installation, Chapter "Boards".

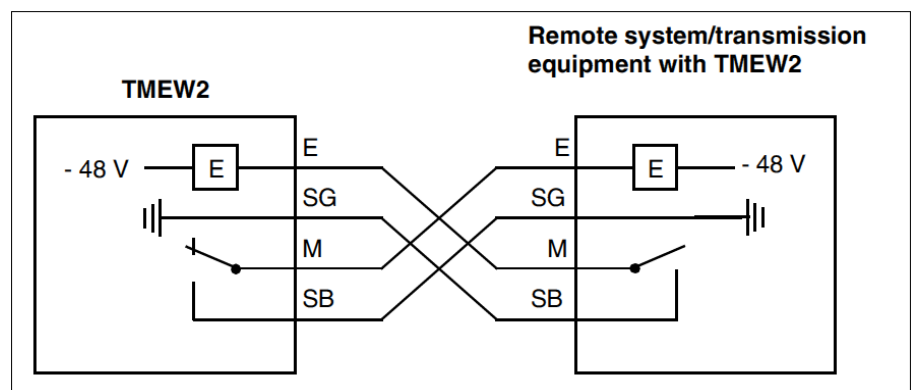

The configuration of the Genius announcement device is performed in Manager E via **System View > Settings > Auxiliary Equipment > Announcement**.

## 21.1.1 How to Add an Analog Announcement Device

### Prerequisites

- Your announcement device is connected to an analog interface.
- You are logged on to the WBM with the **Advanced** profile.

### Step by Step

- 1) In the navigation bar, click on **Setup**.
- 2) In the navigation tree, click **Wizards > Telephones / Stations**.
- 3) Click on **Edit** to start the **Analog Terminals** wizard. A list of all analog stations appears.
- 4) Enter the names and phone numbers in the row of the announcement device.
- 5) If necessary, make additional settings in the row of the announcement device.
- 6) Click on **OK & Next** followed by **Finish**.

## 21.1.2 How to Change the Announcement Delay Time

The configuration is done in Manager E (see also the online help for Manager E):

### *Step by Step*

- › In the **System View** under the **Settings > System Parameters > Time Parameters** menu: In the **Delay for announcement prior to answer** entry in the table, set the **Base** and **Multiplication factor** of the announcement delay to suit your needs (default: 100ms x 20).

## 21.2 Entrance Telephone and Door Opener

Entrance telephones (ET) are offered in a wide range of options from several different manufacturers today. The available connection options are essential for the operation and functionality of each ET. The Doorline a/b T01-T04, which is similar to other door openers by Behnke, Keil, 2n EntryCom, Auerswald, etc., is described here as an example.

### 21.2.1 DoorLine a/b T01-T04

The door opener DoorLine a/b T01-T04 is connected to an analog port. Equipped with 1 to 4 bell buttons (depending on model), several independent residential and commercial areas can be reached. The DoorLine a/b T01-T04 can not only be operated from any phone, but also provides the connection for the power supply of the door opener.

Due to the 2-wire a/b technology, the DoorLine a/b T01-T04 can be quickly and easily mounted. To synchronize with the communication system, the dialing method can be set, and the voice channel can be matched. The door is opened via the code of the Doorline (e.g., #9). A special interface module such as the Doorline M02, M03, M06 and M06/1 is no longer necessary.

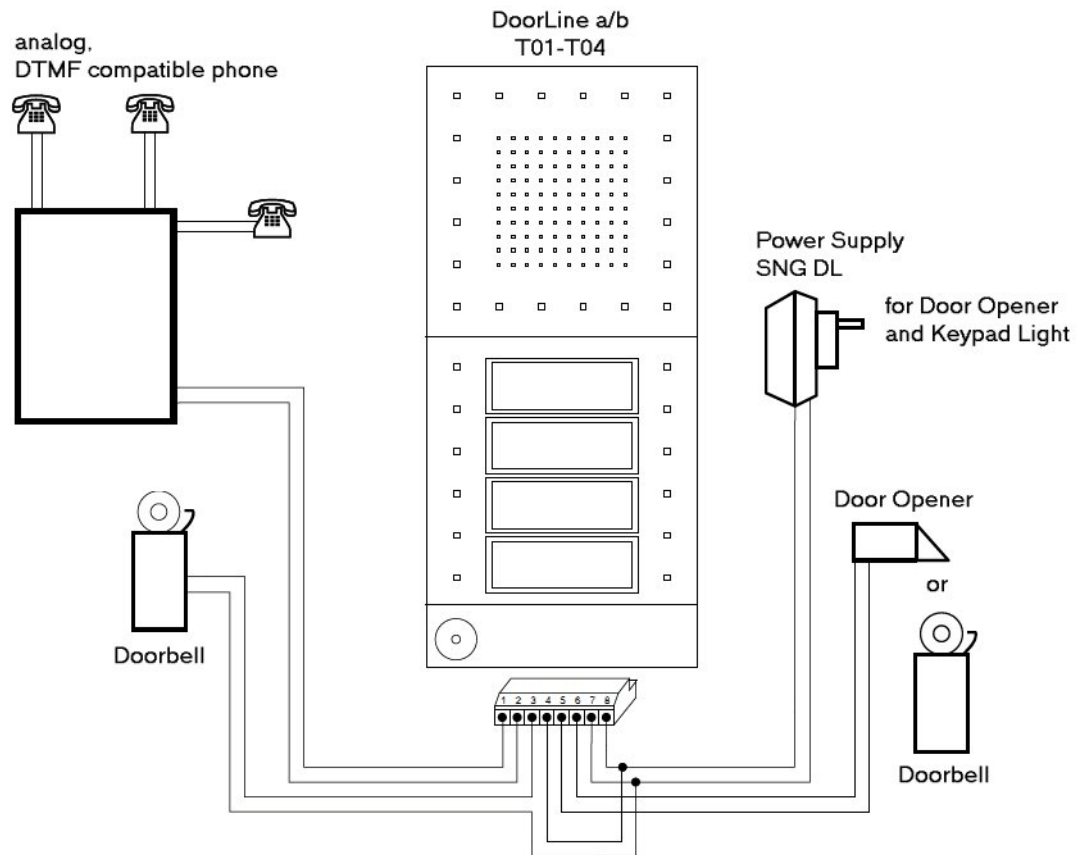

---

**INFO:** No further setting is required in OpenScope Business for this entrance telephone/door opener. For security reasons, it is recommended that the extension be configured with "no trunk access" or with "outward-restricted" trunk access.

---

### 21.2.1.1 How to Configure the Station Port of the DoorLine a/b T01-T04

The configuration is done in Manager E (see also the online help for Manager E):

#### **Step by Step**

- 1) Under **System view**, in the **Settings > Set up station > Stations** menu, select the type **Standard** for the station port.
- 2) Under **Station view**, on the **Flags** tab, enable the flag **Call waiting rejection on** for the station port.
- 3) Under **System view**, in the **Settings > System Parameters** menu, on the **Flags** tab, enable the flag **DTMF automatic**.

### 21.2.1.2 How To Configure the Extension for the Doorline a/b T01-T04

The configuration is done in Manager E (see also the online help for Manager E):

#### *Step by Step*

- 1) Under **Station view**, on the **Flags** tab, enable the flag **Call waiting rejection on** for the extension.
- 2) Under **Station view**, on the **Flags** tab, enable the flag **Missed Calls List** for the extension.

### 21.2.2 DoorCom Analog

DoorCom® Analog is a universal entrance telephone adapter box for Siedle entrance telephones (such as the Vario TLM 612).

The DoorCom® Analog is connected to an analog port of the communication system. It behaves like an analog telephone with DTMF dialing, DTMF detection and DTMF control. It can be operated with DTMF signals.

DoorCom Analog can function only in combination with the following components:

- DoorCom Analog DCA 612-0
- Siedle-Vario TLM 612 entrance telephone
- Switching remote control interface DCSF 600  
For the voice connection of an internal user to the entrance telephone. Without this module, it is not possible to call back to the entrance telephone, for example, if a call was unintentionally cleared down by the entrance telephone.
- Power supply NG 602-0

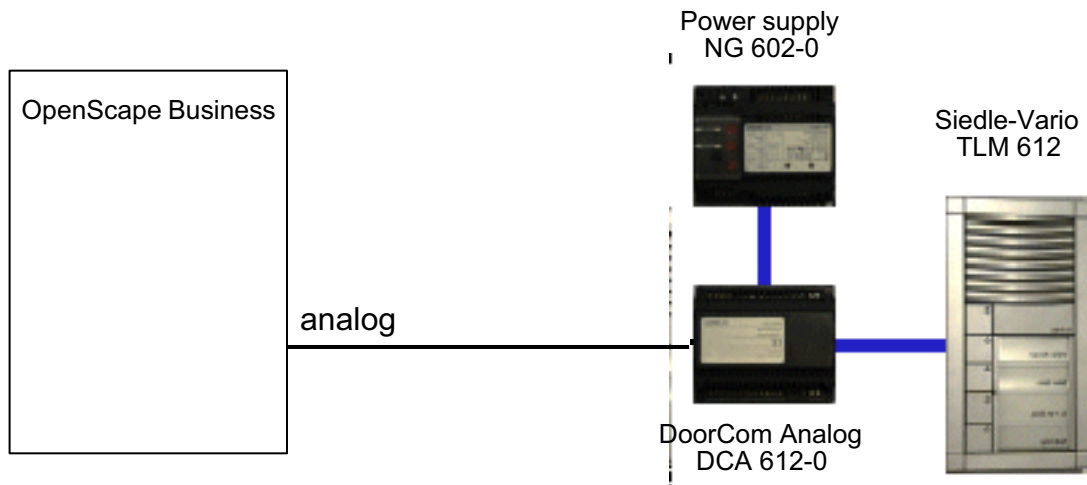

Device control features (open doors, select entrance telephone, etc.) can be programmed on the procedure keys of a phone. The programmed DTMF signal sequence is then sent to the entrance telephone/door opener.

---

**INFO:** No further setting is required in OpenScape Business for this entrance telephone/door opener. For security reasons, it is recommended that the extension be configured with "no trunk access" or with "outward-restricted" trunk access.

---

### 21.2.2.1 How to Configure the Station Port of the DoorCom Analog

The configuration is done in Manager E (see also the online help for Manager E):

#### *Step by Step*

- 1) Under **System view**, in the **Settings > Set up station > Stations** menu, select the type **Standard** for the station port.
- 2) Under **Station view**, on the **Flags** tab, enable the flag **Call waiting rejection on** for the station port.
- 3) Under **System view**, in the **Settings > System Parameters** menu, on the **Flags** tab, enable the flag **DTMF automatic**.

### 21.2.2.2 How to Configure DoorCom Analog Extensions

The configuration is done in Manager E (see also the online help for Manager E):

#### *Step by Step*

- 1) Under **Station view**, on the **Flags** tab, enable the flag **Call waiting rejection on** for the extension.
- 2) Under **Station view**, on the **Flags** tab, enable the flag **Missed Calls List** for the extension.

### 21.2.3 Entrance Telephone with Amplifier (TFE-S)

The TFE-S module (S30122-K7696-T313) connects an analog interface of the communication system with an entrance telephone, a door opener and a doorbell button. Control occurs via the communication system.

This makes it possible to connect to passive entrance telephones, which are comparable with the following types:

- From the company Siedle (TLM511-01, 611-01)
- From the company Rito (5760)
- From the company Grothe (TS6216)

## Auxiliary Equipment

### Entrance Telephone and Door Opener

The amplification can be adjusted manually. The TFE-S module requires its own power supply.

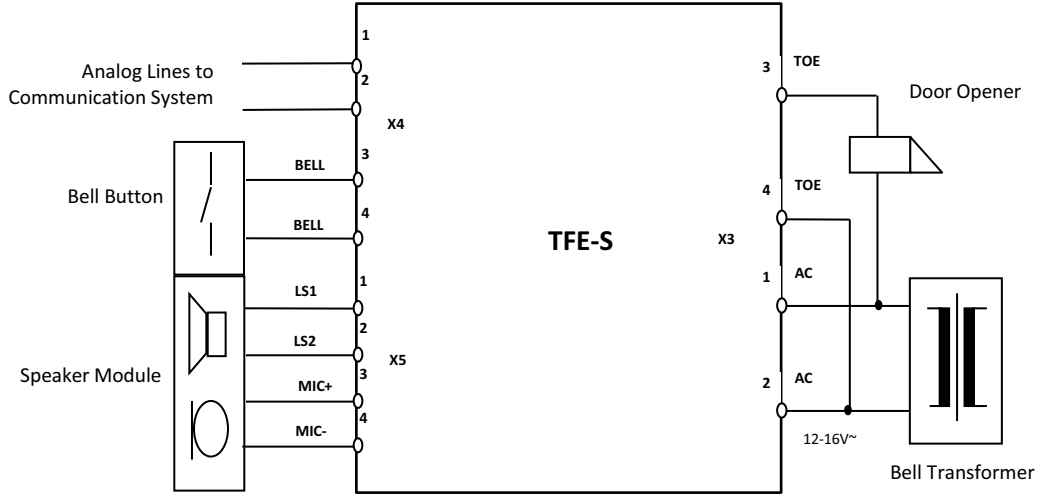

### Technical Data

Parameters	Value
Power supply	Bell transformer 12V - 16V AC, 50Hz
Current draw	Max. 150 mA
OpenScape Business interface	Analog station
Dimensions	100mm x 160mm (5.7" x 9.1")
Ambient temperature	0°C to + 45°C

### Functional description

Doorbell activation is signaled as a call at the phone of any configured station (ring destination). A voice connection to the entrance telephone is set up when the subscriber accepts the call. Additionally, the subscriber can also activate the door opener on his or her phone.

The call is intercepted if the entrance telephone ring destination is not reachable. If the intercept destination is busy, a system search is performed across all system phones.

---

**INFO:** The night service is ignored when signaling a door call.

---



---

**INFO:** System speed dialing at the entrance telephone is not possible.

---



### Configuration Options

The following configuration options are available:

- **Door opener:**  
The door opener is configured via an a/b (T/R) interface and the entrance telephone must be connected via an adapter. The subscriber can then open the door by simply pressing a button on the phone during the connection with the ring destination.
- **DTMF:**  
This setting specifies whether the door opener is activated by a DTMF transmitter (DTMF: dual-tone multifrequency), that is, if the ring destination can open the door with DTMF suffix-dialing.
- **Call Forwarding (CF):**  
This specifies whether the call from the entrance telephone should be forwarded to an external call forwarding destination.

#### 21.2.3.1 How to Configure the Entrance Telephone

The **Door Opener** wizard can be used to specify which subscribers are allowed to operate the door opener. You can configure up to ten entrance phones.

##### *Prerequisites*

- You are logged in at the WBM.

##### *Step by Step*

- 1) In the navigation bar, click on **Setup**.
- 2) In the navigation tree, click on **Wizards > Central Telephony**.
- 3) Click on **Edit** to start the **Door Opener** wizard. The **Edit Door Opener** window appears.
- 4) Select one or more **Stations**.
- 5) Enter the **Destination**.
- 6) Select the relevant functions such as **Door Opener**, **DTMF** and **FWD** in the check box.
- 7) Click on **OK & Next** followed by **Finish**.
- 8) Follow steps 1 to 7 to configure each entrance phone.

#### 21.2.4 Loudspeakers

Speakers can be connected to the communication system via an amplifier.

The following options are available for connecting an amplifier, including the loudspeaker:

- **Connection of the amplifier at an analog station interface**  
A level adjustment of the amplifier may be required for this.

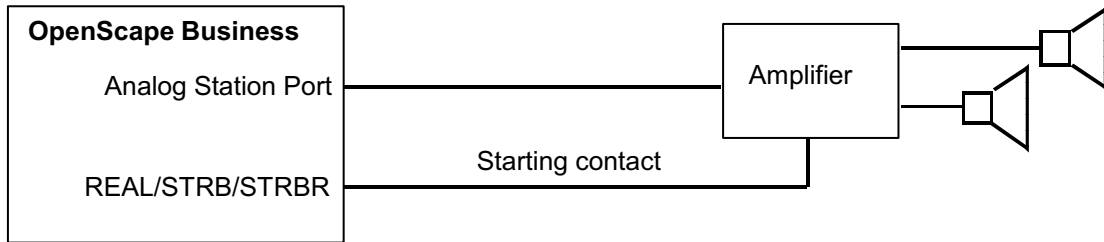

Furthermore, an additional loop resistor as in the following circuit may be needed:

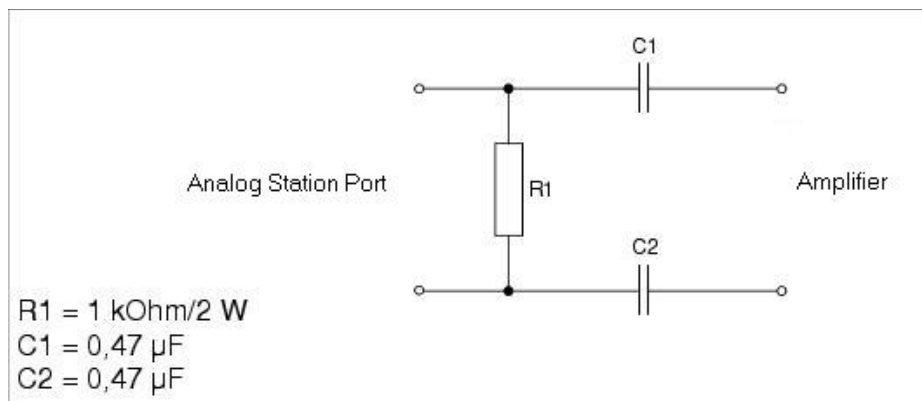

- **Connection of the amplifier to the entrance telephone module TFE-S**  
An active amplifier / sound system can be connected via the TFE-S module. The amplifier input is connected to the speaker output of the TFE-S module. Furthermore, a contact of the STRB board may still be required to turn on the amplifier or switch through the input signal (noise suppression).

### 21.2.4.1 How to Configure the Analog Station Interface for a Loudspeaker

#### Prerequisites

- You are logged into the WBM with the **Expert** profile.

#### Step by Step

- 1) In the navigation bar, click on **Expert Mode**.
- 2) In the navigation tree, click on **Telephony > Stations**.
- 3) In the menu tree, click on **Stations > Analog Stations**.
- 4) Select the desired analog station (e.g., 3011).
- 5) Edit the data of the analog station as needed on the **Edit station parameters** tab.

- 6) Select the item **Loudspeaker** in the **Extension Type** drop-down list.
- 7) Click on **Apply**.

### 21.2.4.2 How to Configure the Analog Station Interface for Connecting an Amplifier to the TFE-S Module

#### *Prerequisites*

- You are logged on to the WBM with the **Advanced** profile.

#### *Step by Step*

- 1) In the navigation bar, click on **Setup**.
- 2) In the navigation tree, click on **Wizards > Central Telephony**.
- 3) Click on **Edit** to start the **Door Opener** wizard. The **Edit Door Opener** window appears.
- 4) Select a **Station**.
- 5) Select the **Destination**.
- 6) Click on **OK & Next** followed by **Finish**.

## 21.3 Relays

Actuators are control outputs which are activated or deactivated by control signals from the communication system. They cause a change in the state of the connected equipment and support functions for monitoring, alerting, control and regulation. They are mainly used in security and building management systems (e.g., for door openers).

Actuators are contained in optional control relay modules. All control relay modules include four control outputs (actuators).

Possible control relay modules:

- REALS (OpenScape Business X8)
- STRB (OpenScape Business X3W/X5W)
- STRBR (OpenScape Business X3R/X5R)

The detailed description of these boards, including the assignments, can be found in the Service Documentation in the section on "Boards".

Actuators can be controlled in one of the following ways:

- from the phone by entering codes
- from the system phone by pressing a key
- remotely via a CO trunk (DISA) by the station assigned to the relay function
- remotely via the "Associated Services" feature

Actuators can be enabled or disabled using the following functions:

---

**INFO:** The control codes can be found the "Expert Mode" section.

---

- **No function**

The actuator is either not operational or entered as a common ringer/night bell (under "Settings" - "Incoming calls" - "Call destination lists").
- **Manual on/off**

The actuator can be activated or deactivated via a key or via the "Activate/deactivate selected switch" code. This function can be assigned to a station, a group or all stations.
- **Auto off on timeout**

The actuator acts as a time switch and can be activated or deactivated via a key or via the "Activate/deactivate selected switch" code. This function can be assigned to a station, a group or all stations. If a value greater than 0 is entered for the switching time, the actuator is deactivated only when the switching time has elapsed.
- **Door opener**

The actuator acts as a door opener and can be activated or deactivated via a key or via the "Activate/deactivate selected switch" code. This function can be assigned to a station, a group or all stations. If a value greater than 0 is entered for the switching time, the actuator is deactivated only when the switching time has elapsed. The text "Door opener" appears on the display of all associated telephones. Example for the switching time multiplication factor:  $30 \times 100\text{ms} = 3 \text{ sec}$
- **Speaker amplifier**

The actuator is activated when a connection is set up to the entrance telephone/door opener/loudspeaker. It is deactivated as soon as the connection is interrupted. This makes it possible to control an entrance telephone amplifier so that it is only activated when required. An entrance telephone or the loudspeaker port must be allocated to this function.
- **Busy indication**

The actuator is activated when the associated station leaves the idle state (i.e., goes off-hook or activates the loudspeaker or receives an incoming call). The actuator is deactivated once the associated station re-enters the idle state. The actuator can also be directly activated via a key or via the "Activate/deactivate selected switch" code. In this case, the status of the associated station is ignored and the actuator can only be deactivated via a key or a code. A specific station must be allocated to this function. Example - Door busy indicator: If the Executive is on the phone, the door busy indicator lights up to show that he or she does not want to be disturbed.
- **Music On Hold**

The actuator is activated if at least one station or a line in the communication system is not in the idle state. In this case, an announcement device or a CD player is activated. The actuator is deactivated if all stations and lines in the communication system are in the idle state. This function can only be assigned to all stations and must only be used once in the communication system. The value for the switching time must be greater than 0 (for example,  $600 \times 100\text{ms} = 60 \text{ sec}$ ). The actuator remains active and plays music until the switching time has elapsed or until it is disabled by a control signal.

- **Secondary bell**  
The actuator is activated for the allocated station if that station is being called. The actuator is deactivated when the called party answers or the call is terminated. The actuator is not clocked. A specific station must be allocated to this function. If a value greater than 0 is entered for the switching time, shutdown can be delayed. The switching time is a multiple of 3 seconds.
- **Call charge pulse**  
The actuator is clocked in accordance with the number for the allocated station on the basis of the incoming call charge pulses or call charge signals. A specific station must be allocated to this function. The switching time is 150 ms pulse and 150 ms break and cannot be changed.
- **Station active**  
The actuator is activated when the associated station is active (off-hook or loudspeaker activated). The actuator is deactivated once the associated station re-enters the idle state. A specific station must be allocated to this function.

#### Actuator Names

Any names (up to 16 characters) can be assigned to the actuators.

## 21.3.1 How to Configure an Actuator

### Prerequisites

- A control relay module has been inserted.

The configuration is done in Manager E (see also the online help for Manager E):

### Step by Step

- 1) **System View**, menu **Settings > Auxiliary Equipment > Actuators**: under **Actuator list**, select the actuator to be configured.
- 2) **System View**, menu **Settings > Auxiliary Equipment > Actuators**: under **Actuator type**, select the actuator function.
- 3) **System View**, menu **Settings > Auxiliary Equipment > Actuators**: in the **Actuator name** field, enter a name of your choice for the actuator (up to 16 characters).
- 4) If the function is to be assigned a station, a group or all stations, select the phone number of the station or the group phone number from the **Call number** list in the **Assigned station** area.  
**None** must be selected for all stations.
- 5) If the function requires a switching time, enter the factor with which the displayed value is to be multiplied in the **Factor** field in the **Switching time** area.

Possible display values: 100 ms and 3 s.

## 21.4 Sensors

Sensors are control inputs and detect a change in the state of the connected device. You can enable or disable functions of the communication system and thus support functions for monitoring, alerting, control and regulation. They are mainly used in security and building management systems (e.g., for temperature control or motion detection).

Sensors are contained in optional control relay modules. All control relay modules include four control inputs.

Possible control relay modules:

- REALS (OpenScape Business X8)
- STRB (OpenScape Business X3W/X5W)
- STRBR (OpenScape Business X3R/X5R)

The detailed description of these boards, including the assignments, can be found in the Service Documentation in the section on "Boards".

Sensors can enable or disable the following functions:

---

**INFO:** The control codes can be found the "Expert Mode" section.

---

- Call signaling on telephones
- Display message on system telephones
- Turning an announcement device on or off
- Answering machine control
- Automatic dialing with a predefined telephone number (internal phone number, group number or external destination call number)
- Activation of the following services for a STN (with code + STN):
  - Actuator on/off
  - Do not disturb
  - Call forwarding on/off
  - Codelock on/off
  - Send message texts
  - Withdraw message texts
  - Night service on/off
  - Ring transfer on/off
- Direct activation of the following services (only with station number):
  - Actuator on/off
  - Use speed dialing system
- Error signaling - The following are possible:
  - Output of a programmable error message (sensor name, max. 10 characters: for example, Temp Alarm) on the display of a specific system telephone (no acoustic signaling)

- Display of calls on a specific system telephone with error message during call (destination call number)
- Error entry in error history (entry in error memory = activated)

### **Destination Call Number**

An associated analog port is programmable for the sensors. This port is called by the system once a setup signal has been received. The calling party then overrides this connection. A recorded announcement can be activated via an answering machine connected to this port, which informs the dialed station of the response of the sensor. An analog port programmed in this way cannot be contacted from the outside. If an external call number has been programmed for a sensor, but an analog port has not, the external connection will be established but an audible signal in relation to the response of the sensor is not transmitted. However, if necessary, the called STN can identify the origin of the call on the basis of the call number (CLIP).

### **Message Texts Box Control Data**

Input of the control string with a maximum of 24 characters for the Phonemail system (mailbox call number). If the connection has been established, the control string is transmitted to the recorded announcement port. If a recorded announcement port is not available, the control string is transmitted to the destination.

## **21.5 OpenStage Gate View**

OpenStage Gate View is a user-friendly entry-level security solution that presents real-time video images on your OpenStage telephone, PC or - when on the road - the iPhone.

This enables you to monitor your entrance area and to control and provide secure access to your corporate premises.

The most important operating steps for users of OpenStage Gate View at an OpenStage 60/80, an iPhone or a web client are explained in the *Quick Reference Guide*.

### **21.5.1 Legal Framework**

Video surveillance refers to the monitoring of locations with optical electronic equipment and is also known as "optical room surveillance system". When using video surveillance, the applicable country-specific regulations and laws must be observed.

#### **Country-specific Legal Situation**

The legal framework for video surveillance in publicly accessible areas varies among countries. You should therefore check the legal situation in your own country.

Areas monitored through video surveillance may need to be identified by a symbol. A corresponding symbol is usually supplied by the camera manufacturer and may look something like this:

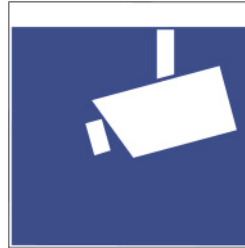

## 21.5.2 Components

In order to use OpenStage Gate View, the components *Source*, *Processing* and *Appearance* are required. All components are connected through a local area network.

### Source

The video source provides the video signal. Cameras from different manufacturers can be used as the source. Depending on the camera type, a video converter may be additionally required.

- IP cameras
- Analog cameras (in combination with composite/IP converter)
- Entrance telephones with integrated camera

The interface for processing the video signal is always an IP video stream.

If a commercial network camera is used as a video source, a LAN with Power over Ethernet (PoE) may be required to connect the camera in some circumstances.

### Processing

To process the video signal, the appropriate server software (which is already integrated into the communication system) is required. No additional hardware for processing the video signal is required.

### Presentation

The presentation can occur on different devices. The following devices are intended for presenting the video signal.

- Devices of the OpenStage Family as of Version V2R0.48.0.
  - OpenStage 60/80 HFA
  - Octophon 660/680 HFA
- iPhone  
Using the iPhone App *OpenStage Gate View*, available in the Apple AppStore.



- Web Browsers  
Presentation within the web-based administration software *Video Surveillance System* or as Web Client.

The recording of the video signal at the server can be controlled from some devices.

### 21.5.3 Function Overview

By using an OpenStage 60/80 HFA telephone, Openstage Gate View makes it possible to offer a powerful combination of the best voice quality, video transmission, and door opener functionality on one device.

Features and benefits

- Video recording on network drive.
- Different displays of multiple video signals on OpenStage telephones, mobile phones (iPhone app) or web clients.
- Simple, password-protected administration via web-based, multilingual interface.
- Flexible licensing concept.
- Integrates into already existing investments (equipment and infrastructure).

#### Capacity Limits

Depending on the platform on which the server software is running, a different number of cameras and devices can be used for the display.

- Hardware platform:
  - 2 cameras
  - 10 OpenStage telephones
  - 10 iPhones or web clients
- Softswitch / Application Server:
  - 8 cameras
  - 20 OpenStage telephones
  - 10 iPhones or web clients

In addition, the maximum number of usable cameras depends on the licenses procured. In this context, a license corresponds to one camera.

### 21.5.4 Menu

This section provides an overview of the menu of the administration software and describes how to set up individual features and parameters.

An overview of the menu functions is shown below.

#### Overview

Displays detailed information about each installed camera with editing options.

### **Surveillance**

Displays the video image for each installed camera.

### **Recording**

Displays details for all recorded video files and also options to play, download or delete them.

### **Status**

Displays information about the hardware and software of the OpenStage Gate View system.

### **Administration**

- **Maintenance**  
Enables the deletion of software and user data.
- **Recording Configuration**  
Enables the configuration of the recording device (recorder) and the recording mode.
- **Door Opener**  
Enables the configuration of an entrance telephone with assignment of camera and telephone.
- **User Management**  
Provides information and settings options for users, profiles and sessions.
- **Cameras**
  - **Installed Cameras**  
Shows all installed cameras as a list.
  - **Add Camera (Auto Discovery)**  
Displays a list of all detected cameras to automatically install a camera.
  - **Add Camera (Manual)**  
Enables the manual installation of a camera.
  - [Name of the camera]:  
Displays detailed information on the selected camera with editing options.
- **Telephones**
  - **Installed Phones**  
Shows all installed phones as a list.
  - **Add Phone (Auto Discovery)**  
Displays a list of all detected phones to automatically install a phone.
  - **Add Phone (Manual)**  
Enables the manual installation of a phone.
  - [Name of the telephone]  
Displays detailed information on the selected phone with editing options.
- **Log**
  - **View Log**  
Displays the current log file with download option.

- **Download Log**  
Downloads the current log file.

## 21.5.5 Initial Setup of OpenStage Gate View

In order to set up the camera and display device, some minimal configuration is required at the OpenStage Gate View server. The setup is usually completed within a few minutes. Depending on the LAN infrastructure and the components used, additional installation steps may be required.

- First, a camera and a phone are assigned to the server configuration.
- After this, an OpenStage 60/80 telephone receives the software required to present the video image and is configured to operate the video function.

If the automatic detection of the camera or OpenStage 60/80 telephone fails, you also have the option to manually add these devices to the configuration.

### 21.5.5.1 How to Start the Server Software for the First Time

The OpenStage Gate View server software is already integrated in the communication system. It must first be activated when it is started for the first time.

#### *Prerequisites*

- An operational OpenScape Business communication system.
- The license for OpenStage Gate View is activated.
- You are logged into the WBM with the *Expert* profile.

#### *Step by Step*

- 1) Navigate in the menu to **Expert mode > Applications > OpenStage Gate View**.
- 2) Click on **Activate** and wait a few seconds until the **Login** button is enabled.
- 3) Click **Login**.

The startup screen of the administration software appears. You are automatically logged into the WBM using the Expert profile.

To increase security, the administrator password should be changed immediately. This change does not affect access the WBM via the expert account.

#### *Next steps*

Change the administrator password.

## 21.5.5.2 How to Change Your Administrator Password

### *Prerequisites*

- You are logged in at the OpenStage Gate View Assistant

### *Step by Step*

- 1) Navigate in the menu to **Administration > User Management**.
- 2) Under **User**, select the user **admin**.
- 3) Click on **Load User**.
- 4) Enter the new password under **Password**.
- 5) Click on **Save User**.

The administrator password has been changed.

### *Next steps*

Add a camera.

## 21.5.5.3 How to Add a Camera

### *Prerequisites*

- An operational network camera as the video source.
- You are logged in at the OpenStage Gate View Assistant

### *Step by Step*

- 1) Navigate in the menu to **Administration > Cameras > Add Camera (Auto Discovery)**.
- 2) If no camera is shown in the list, click on **Scan Network** and confirm this with **OK**.
- 3) Click in the list on **Add Camera** for the camera you want to add.
- 4) Under **Name**, enter any name of your choice for this camera. Allowed characters: uppercase and lowercase letters, digits and the underscore.
- 5) For **Brand**, select the camera type from the list.
- 6) The **IP address** was entered automatically by the network discovery and should not be changed.
- 7) For **Camera port**, enter the default port 80.
- 8) If required, enter the user name for accessing the camera under **User**.
- 9) If required, enter the password for accessing the camera under **Password**.
- 10) Click on **Save**.

The camera is added to the OpenStage Gate View server.

### **Next steps**

Add a telephone.

## **21.5.5.4 How to Add a Telephone**

### **Prerequisites**

- An operational OpenStage 60/80 HFA or Octophon 660/680 HFA telephone with Version V2R0.48.0 or later.
- You are logged in at the OpenStage Gate View Assistant

### **Step by Step**

- 1) Navigate in the menu to **Administration > Telephones > Add Phone (Auto Discovery)**.
- 2) If required, change the default password for accessing the telephone under **Default Phone Password**.
- 3) If no telephone is shown in the list, click on **Scan Network** and confirm this with **OK**.
- 4) Click in the list on **Add Phone** for the phone you want to add.
- 5) Under **Name**, enter any name of your choice for this phone, e.g., the phone number. Allowed characters: uppercase and lowercase letters, digits and the underscore.
- 6) The **IP address** was entered automatically by the network discovery and should not be changed.
- 7) If required, change the password for accessing the administration area of the telephone (default: 123456) under **Phone Admin Password**.
- 8) Click on **Save**.

The phone is added to the OpenStage Gate View server.

### **Next steps**

Enable the video function at the telephone.

## **21.5.6 OpenStage Gate View Video Recording**

OpenStage Gate View enables you to record a video and review it later at any time and as often as desired.

### **Storage location**

The recordings are stored on a network drive.

If the video recorder is set up, you can just start and stop a recording easily from the OpenStage phone. In addition, a time-controlled recording is possible.

The recordings are stored in files named with following syntax:

`recording-type_date-time_camera-name.file-format`

- recording-type:
  - SCH = scheduled recording
  - MAN = manual recording
  - CYC = cyclic (cyclic recording)
- File format: e.g., mp4 or mpeg

### **Quality and Quantity of the Recording Data**

Recordings can be created in varying quality. Recordings with high quality take up more space than low quality recordings.

Space Usage (%): High Quality: approx. 650 MB for 1 hour; Low Quality: approx. 400 MB for 1 hour.

To limit the space used on storage media for the recording, the percentage of space reserved for recordings can be set in advance.

For cyclic recording, the length of a cycle can be set from 30 to 120 minutes. Depending on the amount of storage space available, several files are created, and the oldest among them are overwritten.

### **Restrictions**

Even when using multiple cameras, only the video image of one camera can be recorded at any given time.

A scheduled recording has priority over a manually started recording and will stop the manual recording if required.

Only recordings in mp4 format can be viewed directly in the browser. Recordings in other video formats must first be downloaded in order to be viewed.

Still images (screenshots) cannot be stored directly, but must be created later from the stored video.

Recordings are only possible with cameras of known brands. No recording is possible when the camera brand **other** is selected.

## **21.5.6.1 How to Set up the Video Function at the Telephone**

In order to use the video function on an OpenStage 60/80, this must first be configured. The function can then be controlled via the freely programmable sensor keys on the phone. It is not possible to operate this function via a key module attached to the phone.

### ***Prerequisites***

- An OpenStage 60/80 phone installed in OpenStage Gate View.
- You are logged in at the OpenStage Gate View Assistant

### Step by Step

- 1) Navigate in the menu to **Administration** > Phones > Installed Phones.
- 2) Click on **Details** in the list for the desired phone.
- 3) Click on **Install** and confirm with **OK**.
- 4) Click on **Configure Keys** in the list for the last processed phone.
- 5) For **Video On/Off**, under **With button**, select the desired button with which the video function is to be turned on and off and then enter the appropriate button labels under **Active Label** and **Inactivate Label**, respectively.
- 6) For **Permanent video On/Off**, under **With button**, select the desired button with which the permanent video function (display even during incoming calls) is to be turned on and off and then enter the appropriate button labels under **Active Label** and **Inactivate Label**, respectively.

---

**NOTICE:** Umlaut characters ä,ö,ü,Ä,Ö,Ü are not supported.

---

- 7) For **Recording On/Off**, under **With button**, select the desired button with which a recording is to be started and stopped and then enter the appropriate button labels under **Active Label** and **Inactivate Label**, respectively.
- 8) Click on **Save**.
- 9) Click on **Transfer to Phone** and confirm with **OK**.

The software for displaying the video image is installed on the phone. The key to operate the video function is programmed and labeled appropriately.

## 21.5.6.2 How to Edit Existing Recordings

### Prerequisites

- A recorder has been configured.
- At least one recording exists.
- You are logged in at the OpenStage Gate View Assistant

### Step by Step

- 1) Navigate in the menu to **Recordings** > **Recordings**.
- 2) Click on one of the symbols at the right end of the row with the desired video in order to play back (only recordings in mp4 format), download or delete the video.
- 3) If desired, place a check mark at the left end of the row with the desired video and click on the symbol below the list to delete the selected videos.

## 21.5.7 OpenStage Gate View Entrance Telephone

OpenStage Gate View works with analog entrance telephones (also called door openers). When someone rings at the door, the video image of the door camera automatically appears on the OpenStage phone. You can use the video image on the phone to decide whether the person is to be admitted by pressing a button on the phone.

### Setting up the Entrance Telephone in the Communication Platform

In order to use the entrance telephone function in OpenStage Gate View, the entrance telephone must be first set up correctly on the communication platform, depending on which communication platform is used.

- Setup of the entrance telephone as an analog device at a physical analog port of the communication platform. It is not possible to use a Mediatrix/AP1120 device to connect an analog entrance telephone at an IP port here.
- Setup of an entrance telephone button on the OpenStage phone.
- Setup of the password for the entrance telephone function.

Only one entrance telephone can be used together with OpenStage Gate View in each case.

More information on setting up the function in the communication platform can be found in the appropriate service documentation.

### 21.5.7.1 How to Set up the Entrance Telephone

#### *Prerequisites*

- The entrance telephone function and the corresponding button on the telephones have been set up in the communication platform.
- The call number and the password for the entrance telephones are known.
- You are logged in at the OpenStage Gate View Assistant

#### *Step by Step*

- 1) Navigate in the menu to **Administration > Entrance Telephone > Add Entrance Telephone**.
- 2) Select the **Enabled** check box.
- 3) For **Name**, enter any name for the entrance telephone.
- 4) For **Web Services Server IP**, enter the IP address of the UC Suite or of the UC Smart Assistant.
- 5) For **Web Services Server Port**, enter the port of the UC Smart Assistant.
- 6) If desired, select the **SSL** check box for a secure connection.
- 7) For **Door Opener Station Number**, enter the call number of the entrance telephone.



- 8) Enter the configured password for the entrance telephone function under **Door Opener UC Password**.
- 9) Under **Gate View IP Client**, hold down the <Ctrl> key and select the names of the telephones that were configured for use with the entrance telephone function in Stage Gate View.
- 10) Under **Camera**, select the name of the camera that was configured for use with the entrance telephone function in OpenStage Gate View.
- 11) Click on **Save**.
- 12) Navigate in the menu to **Administration > Phones > Installed Phones**.
- 13) Click on **Configure Keys** in the list for the last processed phone.
- 14) Click on **Save**.
- 15) Click on **Transfer to Phone** and confirm with **OK**.

The entrance telephone function has been set up. When the doorbell rings, the video image from the camera is automatically displayed on the phones. Pressing the door opener button on one of the configured phones opens the door.

## 21.5.8 OpenStage Gate View User Management

As an administrator, you can enable the customized usage of OpenStage Gate View by optionally setting up further users in addition to the default user **admin**.

With these personal user accounts, you can not only obtain a better overview as an administrator, but also implement more security in the use of OpenStage Gate View:

- Each user has a personal account with a user name and password.
- You can temporarily block users.
- You can enforce password changes.
- You can view the session data of users with their respective IP addresses and the time of last use and can optionally end active sessions.
- Using the log file, you can review past activities of different users.

You can create any number of users, edit user data and remove users from the configuration permanently.

### 21.5.8.1 How to Add a User

#### *Prerequisites*

- You are logged in at the OpenStage Gate View Assistant as an administrator.

#### *Step by Step*

- 1) Navigate in the menu to **Administration > User Management**.
- 2) Click on **Add User**.

- 3) Enter the name of the user as the **User name**.
- 4) Enter the initial password for this user under **Password** and **Repeat password**.
- 5) Click on **Send Request**.

The user is created and appears in the **Users** drop-down list.

## 21.5.8.2 How to Edit User Data

### *Prerequisites*

- You are logged in at the OpenStage Gate View Assistant as an administrator.
- At least one further user has been added.

### *Step by Step*

- 1) Navigate in the menu to **Administration > User Management**.
- 2) Select the desired user under **Users**.
- 3) Click on **Load User**.
- 4) Edit the profile data as desired.
- 5) If you want to end the user's session, click on **End Session**.
- 6) Click on **Save User**.

The user data has now been modified.

## 21.5.8.3 How to Delete a User

### *Prerequisites*

- You are logged in at the OpenStage Gate View Assistant as an administrator.
- At least one further user has been added.

### *Step by Step*

- 1) Navigate in the menu to **Administration > User Management**.
- 2) Select the desired user under **Users**.
- 3) Click on **Remove User**.
- 4) Confirm the prompt with **Yes**.

The user data is deleted permanently.

## 21.5.9 OpenStage Gate View Server Administration

As an administrator, you should keep track of the extensive server data and delete the information that is no longer required.

- You can view both the version number of the installed server software as well as the maximum number of devices and licenses.
- You can optionally delete phone and user data permanently.
- You can view the log data of the OpenStage Gate View server and download it.

### 21.5.9.1 How to Open the Administration Interface

#### *Prerequisites*

- OpenStage Gate View is operational.
- You know the IP address of the OpenStage Gate View server.

#### *Step by Step*

- 1) Open an Internet browser and enter the URL together with a port number: `https://[IP address of the communication system]:8009`. The Login window opens.
- 2) Enter **admin** as the `User name` and **adminpass** or your changed password as the `Password`, and then click **Log In**.

The startup screen of the administration software appears.

### 21.5.9.2 How to Display Software Information

You can have information about the software version, the maximum usable devices and the available licenses displayed.

#### *Prerequisites*

- You are logged in at the OpenStage Gate View Assistant

#### *Step by Step*

- › Navigate in the menu to **Administration > Status**.

The software information is displayed.

### 21.5.9.3 How to Delete Server Data

You can delete both software data and recordings selectively as well as the database.

### ***Prerequisites***

- The data to be deleted is present.
- You are logged in at the OpenStage Gate View Assistant

### ***Step by Step***

- 1) Navigate to **Administration > Maintenance**.
- 2) Select one of the following options as desired: **Delete Video SW from OpenStage Phone(s)**, **Delete all Recording Files** or **Reset Database**.
- 3) Click **Apply**.
- 4) Confirm the prompt with **OK**.

The data is permanently deleted.

## **21.5.9.4 How to Display and Save the Log File**

You can view the log file of the server and also download it from the server and save it locally on your PC. Additional log data is available as a trace.

### ***Prerequisites***

- You are logged in at the OpenStage Gate View Assistant

### ***Step by Step***

- 1) Navigate in the menu to **Administration > Log > View Log**.
- 2) If you want to save the log file, click **Download Log**.

The log file is displayed.

## **21.5.10 OpenStage Gate View Customizations**

Most administration tasks have been automated in order to minimize the customized settings that need to be made manually. However, due to the large number of different LAN configurations, it may be necessary to make some individual settings by hand.

- You can add and remove a camera to and from configuration manually.
- You can add and remove a telephone to and from configuration manually.
- At the communication system, you can disable the entire OpenStage Gate View server.

### **Adding a Camera Manually**

Many different camera types have already been stored with the appropriate access data. In such cases, only the camera type needs to be selected, and the IP address adjusted if required.

If you select an Axis camera, a software version of 5.0 or later must be installed on this camera.

If the camera is not included in the list, select **other** and enter the required access parameters, i.e., the camera IP, port, user name and password as a URL. The format usually looks like this:

```
http://<user-name>:<password>@<camera-IP>:<port>
```

All unlisted cameras should be set up on the camera side as follows:

- MJPEG as the video format.
- 12 frames per second.
- Resolution of 320x240 pixels.

### 21.5.10.1 How to Add a Camera manually

If the automatic detection of a camera fails or is not possible, a camera can be added manually.

#### **Prerequisites**

- An operational network camera as the video source.
- You are logged in at the OpenStage Gate View Assistant

#### **Step by Step**

- 1) Navigate in the menu to **Administration > Cameras > Add Camera (Manual)**.
- 2) Under **Name**, enter any name of your choice for this camera. Allowed characters: uppercase and lowercase letters, digits and the underscore.
- 3) For **Brand**, select the camera type from the list. If the camera type is not included in the list, select **Other**.
- 4) Enter the IP address of the camera under **IP address**.
- 5) For **Camera port**, enter the default port 80.
- 6) If required, enter the user name for accessing the camera under **User**.
- 7) If required, enter the password for accessing the camera under **Password**.
- 8) If you selected **other** as the **Brand** from the list, enter a valid stream URL of the camera under **Stream URL**.
- 9) If you selected **other** as the **Brand** from the list, enter a valid snapshot URL of the camera under **Snapshot URL**. This is required for use on mobile devices (iPhone).
- 10) Click on **Save**.

The camera is added to the OpenStage Gate View server.

## 21.5.10.2 How to Delete a Camera

You can delete any specific camera selectively from the configuration.

### *Prerequisites*

- The camera to be deleted exists.
- You are logged in at the OpenStage Gate View Assistant

### *Step by Step*

- 1) Navigate in the menu to **Administration > Cameras > Installed Cameras**.
- 2) Click in the list on **Delete** for the camera to be deleted.
- 3) Confirm the prompt with **Yes**.

The camera is permanently deleted from the configuration.

## 21.5.10.3 How to Add a Telephone Manually

If the automatic detection of a telephone fails, a telephone can be added manually.

### *Prerequisites*

- An operational OpenStage 60/80 HFA or Octophon 660/680 HFA telephone with Version V2R0.48.0 or later.
- You are logged in at the OpenStage Gate View Assistant

### *Step by Step*

- 1) Navigate in the menu to **Administration > Telephones > Add Phone (Manual)**.
- 2) Under **Name**, enter any name of your choice for this phone, e.g., the phone number. Allowed characters: uppercase and lowercase letters, digits and the underscore.
- 3) Enter the IP address of the telephone under **IP address**.
- 4) If required, change the password for accessing the administration area of the telephone (default: 123456) under **Phone Admin Password**.
- 5) Click on **Save**.

The phone is added to the OpenStage Gate View server.

## 21.5.10.4 How to Delete a Telephone

You can delete any specific phone selectively from the configuration.

### ***Prerequisites***

- To phone to be deleted is available.
- You are logged in at the OpenStage Gate View Assistant

### ***Step by Step***

- 1) Navigate in the menu to **Administration > Cameras > Installed Phones**.
- 2) Click in the list on **Delete** for the phone to be deleted.
- 3) Confirm the prompt with **Yes**.

The phone is permanently deleted from the configuration.

## **21.5.10.5 How to Deactivate the OpenStage Gate View Server**

If you no longer need the OpenStage Gate View functions, you can disable the OpenStage Gate View server software in the communication system.

### ***Prerequisites***

- An operational OpenScape Business communication system.
- You have an Expert account in the WBM of the communication system.

### ***Step by Step***

- 1) Open the WBM of the communication system on a PC on the LAN and log in there.
- 2) Navigate in the menu to **Expert mode > Applications > OpenStage Gate View**.
- 3) Click on **Deactivate** and wait for a few seconds until **OpenStage Gate View is deactivated** is displayed beside the button.

The OpenStage Gate View functions will now no longer be available.

## 22 Application Connectivity

Application connectivity is supported by the system, e.g., with CSTA, TAPI, XMPP and Application Launcher.

### 22.1 CSTA

The CSTA interface enables high-performance CTI, Contact Center and Unified Communications applications, etc., to be connected to OpenScape Business.

CSTA uses the Transmission Control Protocol (TCP). A permanent connection is set up. Data packet loss is detected and automatically corrected.

#### Standards

The implemented CSTA protocol is based on:

- ECMA 269 Services for Computer Supported Telecommunications Applications (CSTA) Phase III
- ECMA-285ASN.1 for Computer Supported Telecommunications Applications (CSTA) Phase III
- Specific extensions

#### Prerequisites

The use of CSTA requires either UC Booster (Card or Server) or OpenScape Business S for the system connected with CSTA applications. The login credentials for CSTA applications must be configured in the system to enable the CSTA interface automatically. External CSTA applications must use these credentials for their access.

#### Features

CSTA provides the following features:

- Access via Ethernet LAN (TCP/IP)
- CSTA Phase III, ASN.1 encoding
- Support for the CSTA XML protocol for certified applications
- Wide range of supported system telephones
- Network-wide monitoring and control of all resources
- Multiplexing for monitor points

#### Supported Devices

In addition to the phones supported by the system, CSTA supports the following devices:

- ITSP  
This makes it possible for Call Center applications to be used with SIP trunks
- ISDN



- Analog CO trunks
- Virtual stations
- UCD groups
- MULAPs

---

**INFO:** For details on features and supported devices, please refer to the CSTA Interface Manual.

---

### Connection for network-wide view

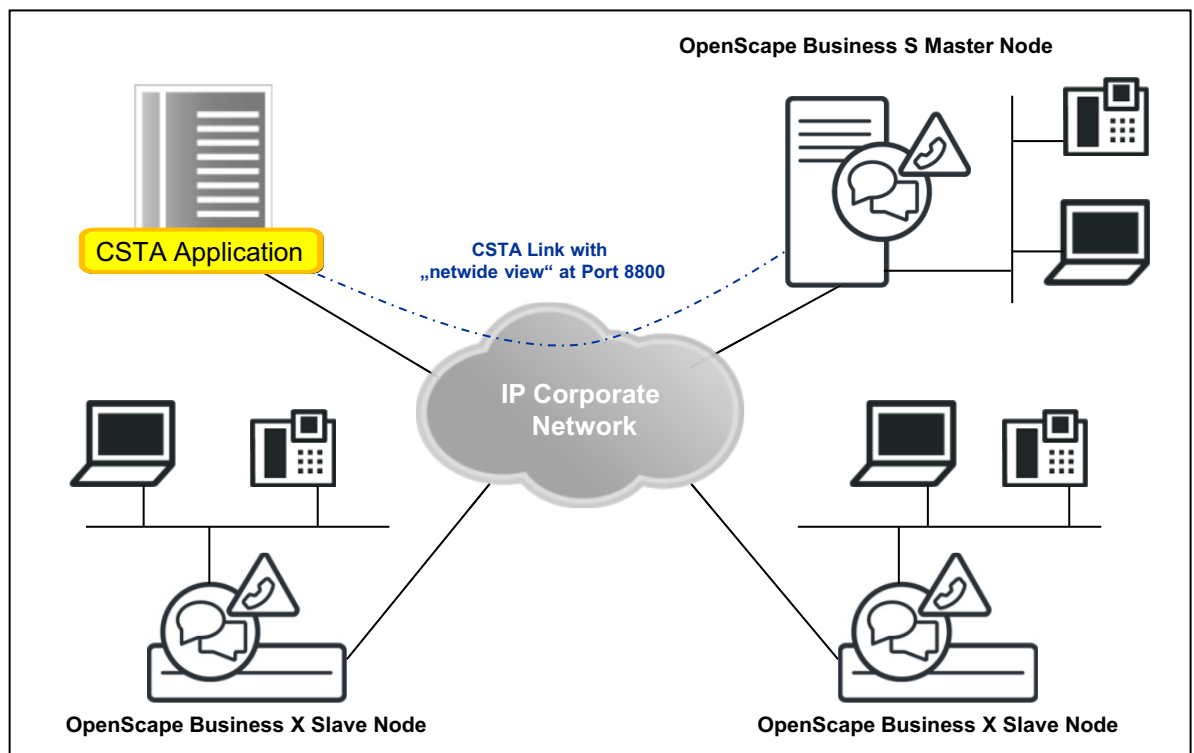

### Ports

The following port numbers are available by default:

Port	Port number	Usage
CSP	8800	any CSTA application
CMD	8900	reserved for TAPI 120 clients; regardless of the number of clients, exactly one logical CSTA link is used

External CSTA applications and TAPI 120 Service Providers must use the IP address of the UC Server or of the system with the appropriate port number in order to set up the connection. The relevant IP address is displayed in the WBM under Application Selection.

### CSTA Links

By default, a CSTA link of the CSP port is available for external CSTA applications. Three other CSTA links are assigned by default to the following integrated CSTA applications or services:

- CMD (CSTA Message Dispatcher) for TAPI 120 clients at the CMD port
- DSS (Direct Station Server)
- UC Suite

If these CSTA applications or services are not needed, the corresponding CSTA links can be assigned to external CSTA applications if required.

### Plus Products

The following flags are always enabled in the system:

- Always transmit area code with phone number
- Enhanced CSTA-CAUSE handling
- CSTA CSP signaling
- MULAP monitoring

---

### Related Topics

- [Supported Phones](#)

## 22.1.1 How to Change the Port Number for CSTA

### *Prerequisites*

- You are logged into the WBM with the **Expert** profile.

### *Step by Step*

- 1) In the navigation bar, click on **Expert Mode**.
- 2) Click **Telephony > Basic Settings** in the navigation tree.
- 3) In the menu tree, click **Basic Settings > Port Management**.
- 4) Enter the desired port number in the row for **CSP** in the input field of the **Port number** column.
- 5) Click on **Apply** followed by **OK**.
- 6) Restart the system.

---

### Related Topics

- [OpenScape Business TAPI 120](#)

## 22.1.2 How to Enable or Disable the CMD for the Use of TAPI 120

### *Prerequisites*

- You are logged into the WBM with the **Expert** profile.

### *Step by Step*

- 1) In the navigation bar, click on **Expert Mode**.
- 2) In the navigation tree, click **Middleware**.
- 3) Click on **Middleware > CSTA Message Dispatcher (CMD)** in the menu tree.
- 4) Click on the **Settings - CSTA Message Dispatcher (CMD)** tab.
- 5) Select one of the following options:
  - If you want to enable the CMD, select the check box **Service will be started automatically** in the **Activation** area.
  - If you want to disable the CMD, clear the check box **Service will be started automatically** in the **Activation** area.
- 6) Select one of the following options:
  - If you want to use auto registration for clients, select the check box **Client auto registration enabled** in the **Auto Registration** area.
  - If you do not want to use auto registration for clients, clear the check box **Client auto registration enabled** in the **Auto Registration** area.
- 7) Click on **Apply**.

---

### **Related Topics**

- [OpenScape Business TAPI 120](#)

## 22.1.3 How to Enable or Disable the DSS Server for the Use of Network-Wide DSS Keys

### *Prerequisites*

- You are logged into the WBM with the **Expert** profile.

### *Step by Step*

- 1) In the navigation bar, click on **Expert Mode**.
- 2) In the navigation tree, click on **Middleware**.
- 3) Click on **Middleware > DSS Server** in the menu tree.
- 4) Click on the **Settings - DSS Server** tab.
- 5) Select one of the following options:

- If you want to enable the DSS server, select the check box **Service will be started automatically** in the **Activation** area.
  - If you want to disable the DSS server, clear the check box **Service will be started automatically** in the **Activation** area.
- 6) Click on **Apply**.

## 22.1.4 How to Activate or Deactivate the CSP

### *Prerequisites*

- You are logged into the WBM with the **Expert** profile.

### *Step by Step*

- 1) In the navigation bar, click on **Expert Mode**.
- 2) In the navigation tree, click **Middleware**.
- 3) Click on **Middleware > CSTA Message Dispatcher (CMD)** in the menu tree.
- 4) Click on the **Settings - CSTA Service Provider (CSP)** tab.
- 5) Select one of the following options:
  - If you want to enable the CSP, select the check box **Service will be started automatically** in the **Activation** area. Enter a CSTA user ID and a CSTA user password as well so that an application can use CSTA.
  - If you want to disable the CSP, clear the check box **Service will be started automatically** in the **Activation** area.

---

**INFO:** If CSP is disabled, TAPI 120 (via CMD), TAPI 170, DSS Server and UC Suite will not work!

---

- 6) Click on **Apply**.

## 22.1.5 How to Enable or Disable the Media Extension Bridge

### *Prerequisites*

- You are logged into the WBM with the **Expert** profile.

### *Step by Step*

- 1) In the navigation bar, click on **Expert Mode**.
- 2) In the navigation tree, click **Middleware**.
- 3) In the menu tree, click on **Middleware > Media Extension Bridge (MEB)**.
- 4) Click on the **Settings - Media Extension Bridge (MEB)** tab.
- 5) Select one of the following options:

- If you want to use the Media Extension Bridge, select the check box **Service will be started automatically** in the **Activation** area.
- If you want to release this CSTA link, clear the check box **Service will be started automatically** in the **Activation** area.

6) Click on **Apply**.

## 22.2 OpenScape Business TAPI 120/170

OpenScape Business TAPI 120 and OpenScape Business TAPI 170, in addition to CallBridge Collection, are two TAPI Service Providers (TSPs) that are optimized for the system architecture and network topology of OpenScape Business. These TSPs provide the Microsoft TAPI interface to TAPI-based applications for the connection to the OpenScape Business communication system.

The connection to OpenScape Business takes place exclusively via the LAN. Additional hardware and software components such as the CSTA Message Dispatcher (CMD) or CSTA Service Provider (CSP) are no longer required for operation with OpenScape Business. The licensing is station based and does not distinguish between OpenScape Business TAPI 120 or TAPI 170 stations. The licensing requirement begins with the first TAPI station.

The choice of the appropriate TAPI Service Provider essentially depends on the number of client PCs to be connected with TAPI applications as well as the existing IT infrastructure and the telephones used.

- **CallBridge Collection**

is used as a traditional first-party TAPI Service Provider on system telephones that have a LAN or USB interface. It is suitable for installations with just a few PCs. A LAN is not necessary for the operation of the CallBridge Collection. The CallBridge Collection is installed on each PC that is running a TAPI application. Analog, Cordless and system telephones without USB/IP interfaces are not supported.

TAPI connections via the CallBridge Collection are not licensed.

- **OpenScape Business TAPI 120**

is used as the preferred first-party TAPI Service Provider in Microsoft networks with or without a domain controller when analog, Cordless and system telephones without USB/IP interface are also to be operated in conjunction with the TAPI application. The TAPI 120 Service Provider is installed on each PC client that is running a TAPI application.

TAPI connections via OpenScape Business TAPI 120 are subject to licensing within OpenScape Business. To connect to OpenScape Business, depending on the operating mode or connection type, one CSTA link or a link to the Web Services Interface is required, regardless of how many TAPI 120 clients are being operated. The scope of functionality on the TAPI side depends on the operating mode and type of connection.

- **OpenScape Business TAPI 170**

is a classic "third-party" TAPI Service Provider. It is installed on a server on the LAN and connected centrally to the OpenScape Business System. TAPI 170 can be used as an alternative to TAPI 120 if there is a domain controller in the Microsoft network. When using the so-called remote TAPI function, it is

not necessary to install the TAPI Service Provider on the client PCs. This offers significant time savings in installations with many client PCs. Please note, however, that the use of OpenScape Business TAPI 170 is mandatory in the following constellations:

- Connection of TAPI stations to networked OpenScape Business systems when the TAPI stations are located in different nodes.
- Connection to TAPI applications running on a terminal server.
- Connection to server-based TAPI applications.

TAPI connections via OpenScape Business TAPI 170 are subject to licensing within OpenScape Business. To connect to OpenScape Business, one CSTA link is required, regardless of how many TAPI 170 stations are being operated.

## 22.2.1 OpenScape Business TAPI 120

OpenScape Business TAPI 120 is a first party telephony service provider that supports the Microsoft TAPI V2.1 functionality. OpenScape Business TAPI 120 enables Windows-based CTI applications to monitor and control a system telephone connected to OpenScape Business.

OpenScape Business TAPI 120 can be alternatively connected to OpenScape Business via the CSTA interface (CSTA mode) or the Web Services Interface (UC Smart mode). A mixed operation using both interfaces to the system is not possible. If a UC Booster Card is plugged into the OpenScape Business system or if a UC Booster Server has been enabled, TAPI 120 can only be operated in the CSTA mode. The system requirements, the maximum number of TAPI stations and the scope of functionality on the TAPI side depend on the operating modes.

### OpenScape Business TAPI 120 Connections

The OpenScape Business TAPI 120 software is installed on a Microsoft Windows client PC. The connection to the OpenScape Business System occurs via a LAN. A physical connection between the Windows PC and the phone is not required.

- **TAPI 120 CSTA mode**

All TAPI 120 client PCs are connected to the same CSTA link of OpenScape Business. OpenScape Business internally multiplexes all TAPI 120 connections.

TAPI 120 in CSTA mode supports OpenScape Business X3/X5/X8 and OpenScape Business S.

**Figure:** TAPI 120 in CSTA Mode with OpenScope Business X5R and UC Booster Card

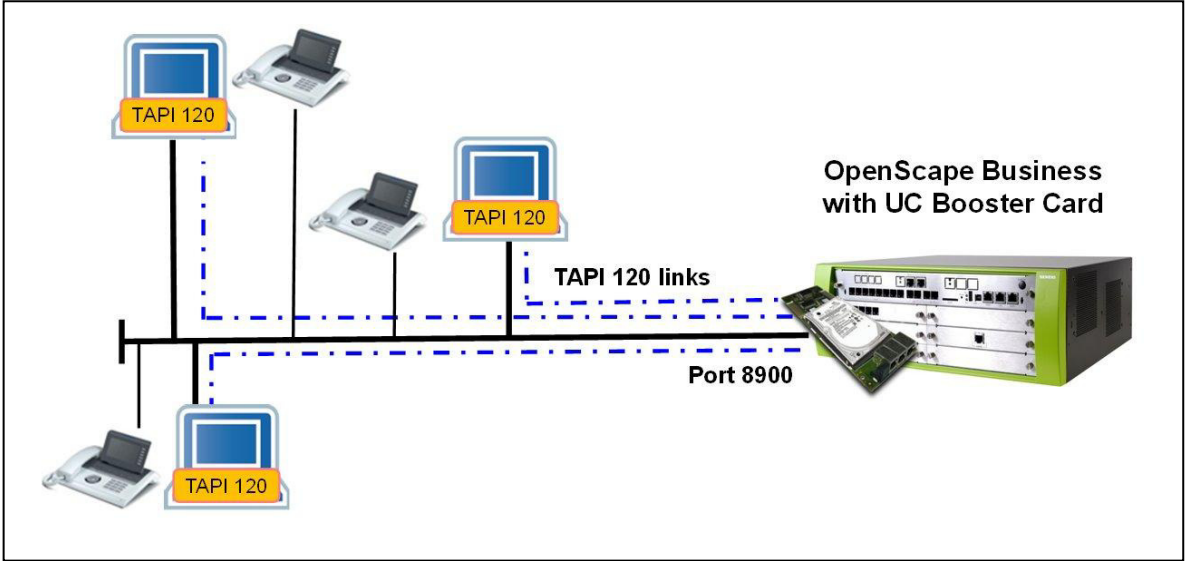

- **TAPI 120 UC Smart mode**  
All TAPI 120 client PCs are connected to the mainboard of OpenScope Business via the LAN and Web Server interface. OpenScope Business internally multiplexes all TAPI 120 connections. TAPI 120 in CSTA mode supports OpenScope Business X1/X3/X5/X8.

**Figure:** TAPI 120 in UC Smart Mode with OpenScope Business X5R

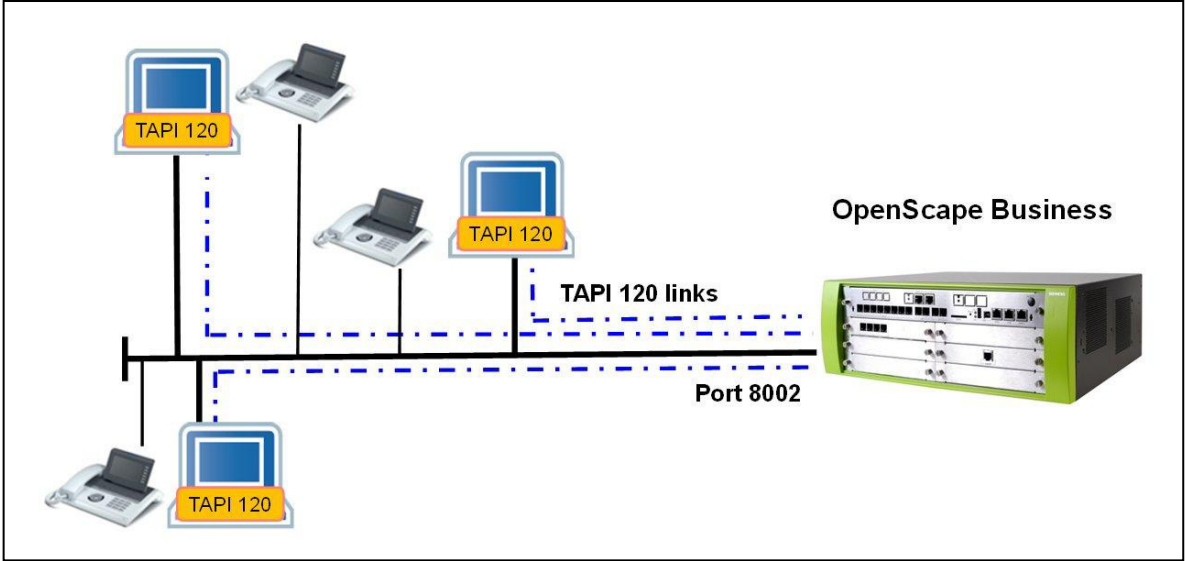

**Features**

The following features are supported:

<b>Feature</b>	<b>TAPI 120 CSTA</b>	<b>TAPI 120 UC Smart</b>
Central first-party TAPI Service Provider connected via a LAN	X	X
Compatible with the Microsoft TAPI 2.1 Standard	X	X
Connection to standalone OpenScape Business system	X	X
Support for the OpenScape Business CTI firewall	X	-
<b>Features supported via TAPI</b>		
Call signaling of incoming and outgoing calls with identification of call numbers and origin of call	X	X
Additional information in the call signaling for redirected calls	X	X
Answering internal and external calls	X	X
Controlled connection setup to internal and external called parties	X	X
Manual dialing / DTMF suffix dialing	X	X
Release existing calls	X	X
Set up consultation call to internal and external parties	X	X
Alternate (toggle/connect)	X	X
Screened call transfer	X	X
Screened call transfer with subsequent dialing of the consultation destination (one-step transfer)	X	X
Unscreened call transfer (blind transfer)	X	-
Set and delete call forwarding	X	X
Set and clear DND	X	X
Initiate conference	X	-
Expand conference	X	-
Forward incoming call	X	-
Directed pickup (call pickup)	X	-
Group signaling and group pickup	X	-
Park existing calls	X	-
Resume parked calls	X	-
Place existing calls on hold manually	X	-
Resume calls placed on hold manually	X	-
Set callback	X	-
Support for code-driven functions	X	-
Call-related data exchange between TAPI applications	X	-
Control of keys on system telephones (HFA)	X	-



Feature	TAPI 120 CSTA	TAPI 120 UC Smart
Control of microphone gain on system telephones (HFA)	X	-
Control/select use of handset/loudspeaker/headset for system telephones (HFA)	X	-
Control volume of handset/loudspeaker/headset/keyboard on system telephones (HFA)	X	-
Access to optiPoint/OpenStage displays and LEDs (with limitation to 50 active displays per system)	X	-

### Maximum Values

The maximum number of TAPI 120 client PCs that can be connected to OpenScape Business depends on the model (see [Expansion Levels Available through Sales](#)).

### Released Operating Systems

The currently released operating systems for the Microsoft Windows Server, the Terminal Server and the remote client PC are listed in the latest Sales Information.

Only Microsoft Windows operating systems can be used in conjunction with TAPI 120.

For installations on terminal servers, OpenScape Business TAPI 170 must be used instead of OpenScape Business TAPI 120.

### Licensing

The use of OpenScape Business TAPI 120 is licensed on a subscriber basis. The TAPI licenses are managed within the OpenScape Business system and can be used for both modes of TAPI 120. When using the MULAP feature, a TAPI license is required for each station within the MULAP.

---

**INFO:** No UC Smart licenses are required for TAPI 120 in UC Smart mode.

---

### Software Provisioning

The OpenScape Business TAPI 120 software is supplied on a separate data medium. It is not part of the OpenScape Business system software.

### Hardware Requirements

The PC must comply with at least the system requirements specified by Microsoft for the operating system used as well as the requirements of the TAPI application. In addition, an Ethernet LAN interface is required.

- For TAPI 120 CSTA  
One CSTA link of OpenScape Business is required, regardless of how many TAPI 120 clients are connected. An OpenScape UC Business Booster (Card or Server) is mandatory for this purpose.

- For TAPI 120 UC Smart  
The Web Services interface is required. There must be no OpenScape UC Business Booster (Card or Server) present in/at the system.

### **Supported Devices**

The supported devices as well as the supported features on these devices depend on the CSTA or the WSI functionality of the OpenScape Business system being used. This information is contained in the OpenScape Business Sales Information.

### **Default IP Port / IP Address Occupied by TAPI 120**

In the TAPI 120 CSTA operating mode, the CSTA link to OpenScape Business occupies IP port 8900.

In the TAPI 120 UC Smart operating mode, the WSI link to OpenScape Business occupies IP port 8802 for an encrypted connection (HTTPS) or 8801 for an unencrypted connection (HTTP).

In the TAPI 120 configuration, the IP address of the OpenScape Business system must be entered in accordance with the operating mode. This IP address is displayed in the WBM under **Application Selection**.

---

### **Related Topics**

- [How to Change the Port Number for CSTA](#)
- [How to Enable or Disable the CMD for the Use of TAPI 120](#)

## **22.2.2 OpenScape Business TAPI 170**

OpenScape Business TAPI 170 is a third party telephony service provider that supports the Microsoft TAPI V2.1 functionality. TAPI 170 enables Microsoft Windows-based CTI applications to concurrently monitor and control telephones connected to OpenScape Business.

### **Features**

OpenScape Business TAPI 170 provides the following features:

- Centrally connected third-party TAPI Service Provider
- Compatible with the Microsoft TAPI 2.1 Standard
- Telephony functions are available on each connected PC client via the TAPI 2.1 client/server architecture
- No additional TSP client software is required
- Supported telephony features:
  - Selection or dialing of incoming/outgoing calls from the PC
  - Transmission of incoming call number, if signaled
  - Consultation and transfer
  - Toggle/Connect

- Conferencing
- Call forwarding
- Forwarding callers
- Answering a call through the application
- Initiating a call through the application
- Blind/Supervised transfer (also called "transfer before answer / consultation transfer")
- Transmission of feature codes
- Monitoring of the phone (call states, failure, etc.)
- Provision of an ACD interface
- Monitoring/access to keypad for system telephones (HFA)
- Control of display/LED for system telephones (HFA)
- Connection to standalone and networked OpenScape Business systems
- Support for MULAP members/station numbers

### **OpenScape Business TAPI 170 Connections**

The OpenScape Business TAPI 170 software is installed on a Microsoft Windows server on the network. The connection to OpenScape Business occurs via a CSTA link. A physical connection between the Windows PC and the phone is not required. OpenScape Business TAPI 170 can be set up in different operating modes on standalone systems or in the OpenScape Business network. The TAPI server and clients must be managed by the same network domain controller.

- **Connecting Server-based TAPI Applications to OpenScape Business using TAPI 170**

The server applications and the TAPI 170 software are installed on the so-called "Telephony Server" in the network. The server applications provide their associated clients in the network with telephony features for the stations that are configured within OpenScape Business TAPI 170. The TAPI 170 software is connected to the CSTA interface of OpenScape Business over the LAN. For this connection, one CSTA link of OpenScape Business as well as one TAPI license for each configured TAPI station are required.

Figure: Server-Based TAPI Application via TAPI 170 to OpenScape Business

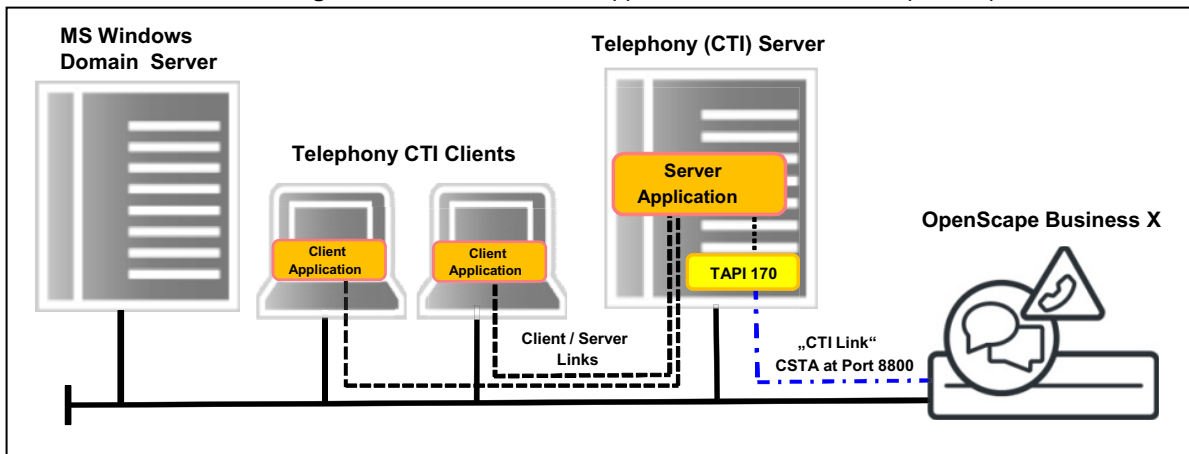

- **Connecting Client-based TAPI Applications to OpenScape Business using TAPI 170 with the "Remote TAPI" Function**

In this scenario, the OpenScape Business TAPI 170 software is installed on a server on the network. On the client PCs with the TAPI applications, the so-called "Remote TAPI" function is enabled, via which the TAPI application on the client communicates with the TAPI 170 software on the server. No TAPI 170 software needs to be installed on the client for this purpose. The TAPI 170 software is connected to the CSTA interface of OpenScape Business over the LAN. For this connection, one CSTA link of OpenScape Business as well as one TAPI license for each configured TAPI station are required.

Figure: Client-Based TAPI Application via "Remote TAPI" to OpenScape Business

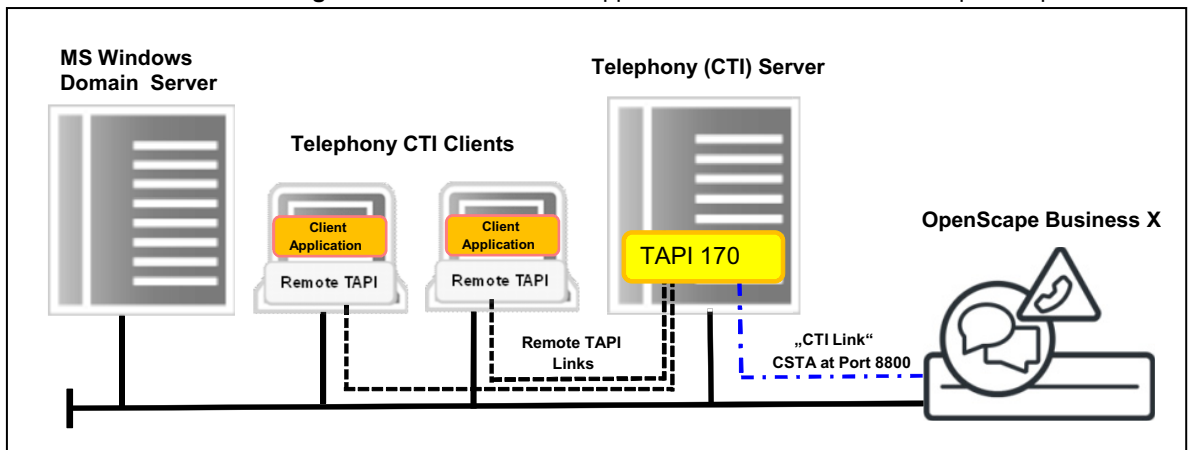

- **Connecting Terminal Server-based TAPI Applications to OpenScape Business using TAPI 170**

In this scenario, the client-based TAPI applications are installed on one or more terminal servers. In this case, the TAPI 170 software is also installed on the terminal server. In the case of a cluster consisting of multiple terminal servers, the TAPI 170 software must be installed on each terminal server in the cluster. Each instance of the installed TAPI 170 software is connected to OpenScape Business over the LAN. For each instance of the TAPI 170 software installed on a terminal server, one CSTA link of OpenScape

Business is required. In addition, a TAPI license is also required for each configured TAPI station.

The maximum possible number of OpenScope Business TAPI 170 servers in conjunction with OpenScope Business must not be exceeded.

---

**INFO:** The number of terminal servers that can be operated in the cluster is limited to the number of free CSTA links available within OpenScope Business for connecting the TAPI 170 software. The maximum number of possible connections is reduced if the CSTA links of OpenScope Business are used by other CSTA applications.

---

**Figure:** Client-Based TAPI Applications on Terminal Server to OpenScope Business

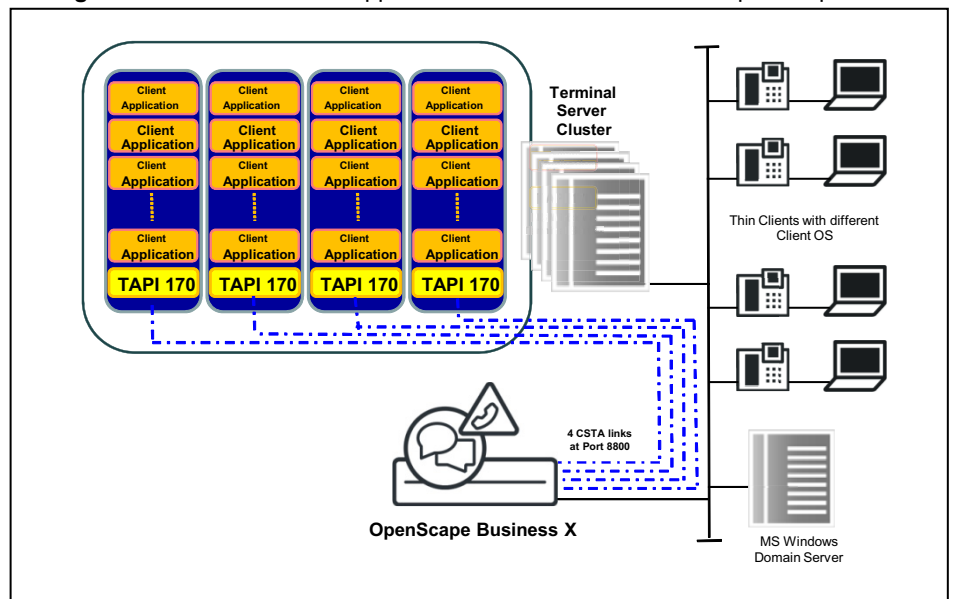

- **Connecting TAPI 170 to Networked OpenScope Business Systems**  
For networked OpenScope Business systems, the TAPI 170 software is installed on one server, which is connected via the LAN to the CSTA interface of the master node. This connection is independent of the previously mentioned operating modes of the TAPI 170 Service Provider (remote TAPI or server-based connection). To implement this connection, one CSTA link of the OpenScope Business master node as well as one TAPI license for each configured TAPI station are required.

---

**INFO:** Via the master node, the TAPI 170 receives network-wide access to all stations in the network. If the TAPI 170 is connected to a slave node instead of the master node, TAPI 170 can access only the stations of the slave node. When using multiple TAPI 170 in a terminal server cluster, one CSTA link to the master node is required for each TAPI 170.

---

Figure: Connecting TAPI 170 to Networked OpenScape Business Systems

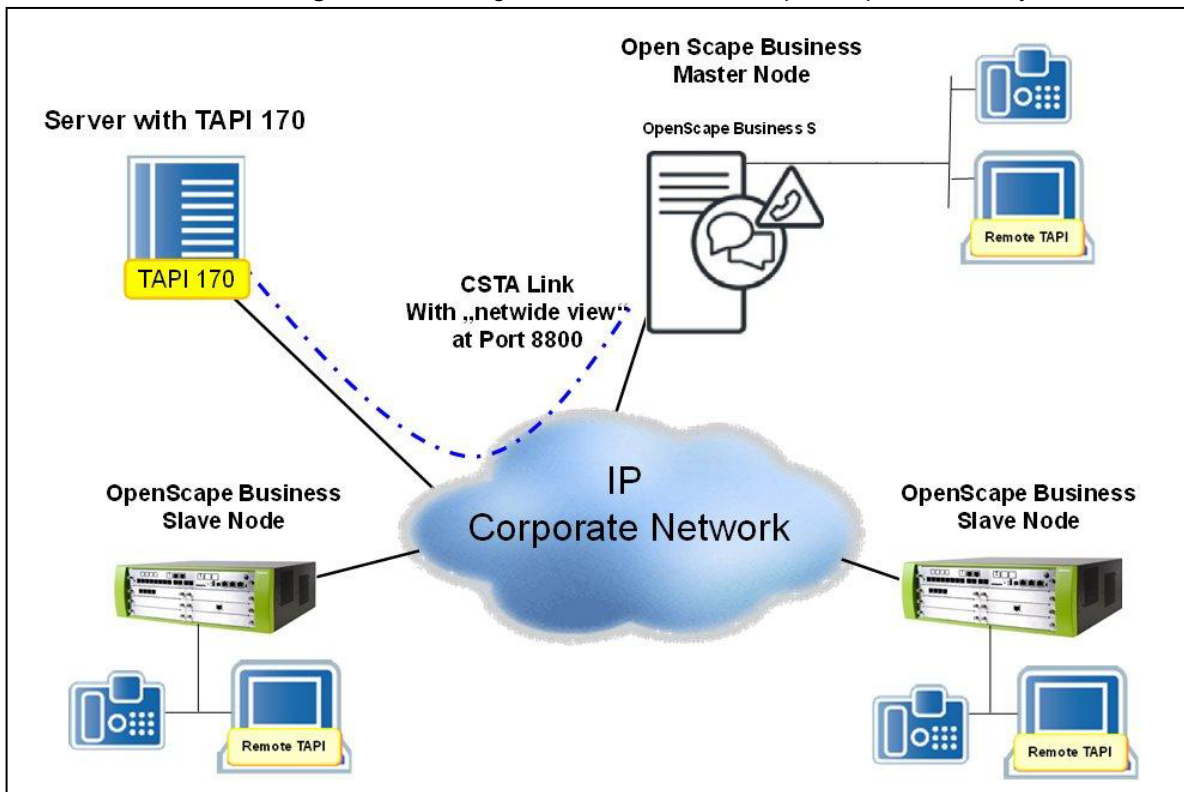

### Capacity Limits

The maximum number of TAPI 170 client PCs that can be connected to OpenScape Business depends on the model. More information on this can be found in section 1.3.9.4

### Released Operating Systems

The currently released operating systems for the Microsoft Windows Server, the Terminal Server and the remote client PC are listed in the latest Sales Information.

Only Microsoft Windows operating systems can be used in conjunction with TAPI 170.

In addition to the license for the server operating system, the Microsoft licensing model requires Microsoft device or User CALs corresponding to the number required for the planned expansion. These CALs are not included in the delivery of OpenScape Business TAPI 170 and must be purchased separately. Under certain conditions specified by Microsoft, a "Windows Server for embedded systems" with the so-called "embedded Telco license" can be used for OpenScape Business TAPI 170.

### Licensing

The use of OpenScape Business TAPI 170 is licensed on a subscriber basis. The licenses are managed within the OpenScape Business system. When using the MULAP feature, a TAPI license is required for each station within the MULAP.

### Software Provisioning

The OpenScape Business TAPI 170 software is supplied on a separate data medium. It is not part of the OpenScape Business system software.

### Hardware Requirements

In order to connect to OpenScape Business TAPI 170, one CSTA link of OpenScape Office is required, regardless of how many TAPI 170 clients are connected. This also applies to networked OpenScape Business systems.

The PC must comply with at least the system requirements specified by Microsoft for the operating system used, provided that no further software applications other than TAPI 170 are being operated. In addition, an Ethernet LAN interface is required.

### Supported Devices

The supported devices as well as the supported features on these devices depend on the CSTA or the WSI functionality of the OpenScape Business system being used. This information is contained in the OpenScape Business Sales Information.

## 22.3 Web Services Interface

The integrated web services interface enables the monitoring and control of telephony resources in a system with UC users.

### Features

The web services interface provides the following features:

- Access via Ethernet LAN (TCP/IP)
- Support for HTTP and HTTPS
- Support for individual systems
- User-oriented, clearly structured functions for:
  - Call control
  - Device control
  - Monitoring devices
  - Directories
  - Journals of users
  - Presence status of users

---

**INFO:** Depending on the WSI (Web Services Interface) client type, station flag Associated Services must be activated in order to enable execution of some of the WSI commands.

---

### Web Server WebSessions

The number of available web server sessions is common to all relevant applications (e.g., myPortal to go, Application Launcher, optiClient Attendant (Server) and optiClient BLF.

### Internal Monitor Points

The internal monitor points are independent of the monitor points of the CSTA interface. If several applications monitor the same UC user via the web services interface, only a single internal monitor point is used by the web server for this purpose.

### Ports

The following port numbers are available:

Port	Protocol
8801	HTTP (unencrypted)
8802	HTTPS (encrypted)

## 22.4 Open Directory Service

Open Directory Service is an open, integrated metadirectory service that can be accessed by several different types of clients, applications and communication devices in a company. The Open Directory Service performs two functions: it enables additional contact data from external data sources to be integrated in the directories of the system, while also making the directories available to clients, communication devices and applications.

Open Directory Service runs as a separate service based on OpenLDAP. Firewalls must be open for port 389. Open Directory Service is disabled by default.

### Internal Data Sources

The following internal data sources are available by default in the Open Directory Service:

- External directory
- Internal directory
- Central speed-dial numbers

For these internal data sources, the field names are permanently mapped to the data schema of the Open Directory Service.

These internal data sources cannot be deleted or modified.

### External Data Sources

As an administrator, you can integrate contact information from the following types of databases as data sources for read-only access via ODBC.



- Relational data sources (Microsoft SQL Server, PostgreSQL, Sybase, SQL Server)
- Non-relational data sources require an installed and configured ODBC Bridge Server on the ODS client (downloadable via the WBM under **Service Center > Software**).

Maximum number of different types of databases: 3

Maximum number of external data sources: 4

Make sure that the Open Directory Service is authorized to access the external data source. Contact the responsible database administrator in advance to ensure that this is the case. A separate user may need to be added in the external data source for access by the system.

External data sources can be used in the context of both directory searches and the resolution of call numbers into names.

You can configure direct access to a database table from an external data source or a custom SQL query for the data source.

Any column which serves as an ID must contain unique and not null/not empty values. Use the UNIQUE or PRIMARY KEY property to ensure that this is the case.

In cases where external databases are integrated, the following restrictions apply:

- The special characters ' [ ] ' " are not supported by the ODS in table names and column names.
- The column types "nchar" and "nvarchar" are not supported by the ODS.

In case of ODBC bridge data source for Access, Firebird and Excel data sources please add the word "access", "firebird", "excel" respectively to the description field.

### Custom SQL Queries for External Data Sources

Custom SQL queries also support related tables, e.g.:

```
SELECT * FROM users LEFT OUTER JOIN phonenumbers ON users.id = phonenumbers.uid;
```

The data structure must be of the type 1:1 or n:1, i.e., each record can have only a single row.

Access via custom SQL queries can sometimes run much slower than direct access to a database table.

Custom SQL queries with potential security risks are not executed, for example:

- Modifying data
- Stopping the SQL server
- Running programs via the SQL server
- Changing user rights

Custom SQL queries with the following SQL commands are therefore not executed:

- CHECKPOINT

- CLOSE
- CLUSTER
- COMMIT
- COPY
- CREATE
- DEALLOCTAE
- DECLARE
- DELETE
- DISCARD
- DO
- DROP
- END
- EXECUTE
- EXPLAIN
- FETCH
- GRANT
- INSERT
- LOAD
- LOCK
- MOVE
- PREPARE
- REASSIGN OWNED
- REINDEX
- RELEASE SAVEPOINT
- RESET
- REVOKE
- SAVEPOINT
- SECURITY LABEL
- SELECT INTO
- SET
- SHOW
- START TRANSACTION
- TRUNCATE
- UNLISTEN
- UPDATE
- VACUUM
- VALUES

### **Field Mapping for Data Sources**

For these data sources, you can customize the mapping of field names to the data schema of the Open Directory Service. You can assign each field in the data schema of the Open Directory Service to no more than one field of the external

data source. However, you can assign a field of the external data source to multiple fields in the data schema of the Open Directory Service.

### LDAP Data Output Mappings

An LDAP data output mapping determines which of the fields in the data schema of the Open Directory Service are to be output via LDAP, e.g., for specific LDAP clients or for different groups of subscribers who do not want to see all the details, but only a defined subset.

The LDAP data output mapping **web** is available by default and cannot be deleted or changed. All fields of the data schema in the Open Directory Service are permanently assigned to the LDAP output in it. You can also configure other LDAP data output mappings.

LDAP clients can access a specific LDAP data output mapping via the `dc` parameter in the LDAP login, for example: `dc=web`.

### Normalization of Phone Numbers in the Canonical Format

For each data source, you can configure the normalization of phone numbers in the canonical format. During this process, blanks, parentheses, hyphens and commas are removed. This is required to correctly identify the caller's name and for desktop dialing. You should not skip the normalization, unless the phone numbers used in the data source are already present in canonical format. You can have the normalization-related values such as the area code, etc., entered automatically from the system. If the external data source is located at a different site than the system, you may need to adjust these values.

### Status of Data Sources

The status display under **OpenDirectory > Data Sources** has the following significance:

Color	Status
green	active
red	ODBC and LDAP is not OK, wrong configuration or data source unavailable
yellow	LDAP not ok: restart the Open Directory Service
gray	Configuration incomplete

### Provision of directories

The following types of clients, communication devices and applications can use the directories provided by the Open Directory Service:

- UC Clients
- Application Launcher
- System Directory
- OpenStage with local LDAP support
- DECT IP phones (via LDAP)

- SIP phones (via LDAP)
- Applications, e.g., CRM Suites such as Microsoft Dynamics CRM (via LDAP, ODBC or OpenLDAP CSV export)

Open Directory Service can identify in the search results the data source from which a hit is obtained.

## 22.4.1 How to Enable or Disable the Open Directory Service

### *Prerequisites*

- You are logged into the WBM with the **Expert** profile.

### *Step by Step*

- 1) In the navigation bar, click on **Expert Mode**.
- 2) In the navigation tree, click on **Applications > Open Directory Service**.
- 3) Click on **Open Directory > Basic Settings** in the menu tree.
- 4) Select one of the following options:
  - If you want to enable the Open Directory Service, select the **Active** check box.
  - If you want to disable the Open Directory Service, clear the **Active** check box.
- 5) Click on **Save**.
- 6) Click on **OK**.
- 7) Click on **OK**.

## 22.4.2 How to Restart the Open Directory Service

### *Prerequisites*

- You are logged into the WBM with the **Expert** profile.
- Open Directory Service is enabled.

### *Step by Step*

- 1) In the navigation bar, click on **Expert Mode**.
- 2) In the navigation tree, click on **Applications > Open Directory Service**.
- 3) Click on **Open Directory > Maintenance** in the menu tree.
- 4) Click on **Restart**.
- 5) Click on **OK**.

## 22.4.3 How to Configure the Password for Access to the Open Directory Service

### *Prerequisites*

- You are logged into the WBM with the **Expert** profile.

Follow these steps to set the password with which clients, communication devices and applications can access the Open Directory Service.

### *Step by Step*

- 1) In the navigation bar, click on **Expert Mode**.
- 2) In the navigation tree, click on **Applications > Open Directory Service**.
- 3) Click on **Open Directory > Basic Settings** in the menu tree.
- 4) Enter the desired **Password**.
- 5) Click on **Save**.
- 6) Click on **OK**.

## 22.4.4 How to Configure the ODBC to ODBC Bridge Server

### *Prerequisites*

- The ODBC Bridge Server was downloaded from the WBM under **Service Center > Software** and installed on a Windows PC (32 bit or 64 bit) with data sources that can access relational or non relational databases. The ODBC Bridge Server is required for ODBC drivers to access the data source.
- The data source must be configured as a DSN on the ODS client via the ODBC data source administration.
- The user name and password of the data source are known.

The configuration of the ODBC Bridge Server is described here for the English user interface. The configuration can, of course, also be performed using a different interface language (**Server Manager > Language** tab).

### *Step by Step*

- 1) Right click on the ODBC Bridge Server icon in the tray bar and select the menu item **Settings**.
- 2) Define the general server settings:
  - a) Click on the **Server Settings** tab.

- b)** Under **Connection Settings**, select the IP address under which the ODBC Bridge Server is to be accessible to the ODBC client (OpenScape Business) from the **Network Interface** drop-down list.

This IP address must be entered for the ODS configuration in the WBM of OpenScape Business.
- c)** Under **Port**, enter the port through which the queries of the ODBC client (OpenScape Business) are to be received.

This port must be entered for the ODS configuration in the WBM of OpenScape Business.
- d)** If the service is stopped, you can activate the **Service Status** by setting it to **On** under **Service Control**, or by selecting **Start service** in the tray bar.
- e)** If the service is connected, you can disable the **Service Status** by setting it to **Off** or by selecting **Stop service** in the tray bar.
- f)** Under **Network Settings**, you can enable the encryption by setting it to **On**.
- g)** Under **Network Settings**, enter the maximum number of simultaneous connections to ODBC clients (minimum: 1, maximum: 20) in the **Max Connections** field.
- h)** Click **Save Settings**.

---

**INFO:** After saving the settings, a service restart is required.

---

- 3)** Create a user for the ODBC client access to the data source:

  - a)** Click on the **Role Management** tab.
  - b)** Click **Add User**.
  - c)** Assign a user name for the ODBC client in the **Username** field.
  - d)** Enter a password for the ODBC client in the **Password** and the **Re-Enter Password** fields.

The same user details must be entered for the ODS configuration in the WBM of OpenScape Business.
  - e)** Select the DSN to which the ODBC client should have access, by checking the box under the **Access** column.
  - f)** Enter the **DB Username** and **Password** if required.
  - g)** Click **Save Settings**.
- 4)** Click on the **Monitoring** tab to monitor the connections. The following details are displayed:

  - The installed ODBC drivers' names and versions.
  - The name and the IP address of the ODS client, the last active connection time and the total active connection time.
  - The available ODBC datasources (via the **Open Windows Datasource Administrator** link).

- 5) Click on the **Logs** tab to enable the creation of log files and set which trace levels should be logged:
  - a) Enable logging by setting it to **On**.
  - b) Select the **Log Level: Everything** for all logs, **Normal** for service logs or only **Warnings and Errors**.
  - c) Select the log type from the drop-down list. You can select to view the logs folder or the log console.
- 6) Click on the **Appearance** tab to change the appearance:
  - a) Select a theme (dark or light).
  - b) Select a style.
  - c) Set the desired language.
  - d) Select whether the service should run automatically on startup.
  - e) Select whether the service can be minimized to tray.
- 7) Click on the **About** tab to view the service details and the available updates.

---

**INFO:** If a new version is available, click **Install** to run the update.

---

- 8) Select **Exit** in the tray bar, to close the service configuration.

## 22.4.5 How to Add an External Data Source for the Open Directory Service

### *Prerequisites*

- You are logged into the WBM with the **Expert** profile.
- The access data of the external database is available.

### *Step by Step*

- 1) In the navigation bar, click on **Expert Mode**.
- 2) In the navigation tree, click on **Applications > Open Directory Service**.
- 3) Click on **Open Directory > Data Sources** in the menu tree.
- 4) Click **Add**.
- 5) Click on the **Database** tab.
- 6) Enter the **Name** of the data source.
- 7) Enter a **Description** for the data source.
- 8) If you want to add an SQL database:
  - a) Select the type **PostgreSQL** or **Microsoft SQL Server, Sybase SQL** from the **ODBC Driver** drop-down list.
  - b) Enter the PV4 address of the database under **Database Server Address**.

- c) Specify the **Database Server Port**.
  - d) Enter the **Database Name** in the correct case.
  - e) Enter the **Database login** in the correct case.
  - f) Enter the **Database password** in the correct case.
  - g) If you selected the type **ODBC Bridge** in the **ODBC Driver** drop-down list, enter the TDS protocol version in the **TDS Protocol Version** field.
- 9) If you want to add a non-SQL database:
- a) Select the type **ODBC Bridge** from the **ODBC Driver** drop-down list.
  - b) Enter the IPv4 address of the database in the **ODBC Bridge Server Address** field.
  - c) Enter the **ODBC Bridge Server Port**.
  - d) Enter the correct case-sensitive **ODBC Bridge Server Login**.
  - e) Enter the correct case-sensitive **ODBC Bridge Server Password**.
  - f) Enter the **Database Name** in the correct case.
  - g) Enter the **Database login** in the correct case.
  - h) Enter the **Database password** in the correct case.
- 10) Click on **Check database access** to test the access.
- 11) Click **Save**.
- 12) Click on the **Data Access Method** tab.
- 13) If you want to use a database table:
- a) Click on **Simple selection - access one table**.
  - b) Click on **Query database tables** and select the desired table in the **Database tables** list.
- 
- INFO:** This functionality is not supported for some datasources (e.g. Oracle). If so please provide the table name manually.
- 
- c) Click on **Preview database table** and navigate through the records in the preview with the aid of the appropriate buttons.
- 14) If you want to use a custom SQL query:
- a) Click on **Self-defined SQL query**.
  - b) Enter the SQL query in the **Define SQL query** field.
  - c) Click on **Preview query results** and navigate through the records in the preview with the aid of the appropriate buttons.
- 15) Click on the **Field mappings** tab.



---

**INFO:** All columns of the selected table and all columns returned by the custom SQL queries are available for field mappings.

---

- 16) Click on **Add Field Mapping**.
- 17) Select the field of each external data source in the drop-down list on the left and then select the corresponding field to be mapped in the data schema of the Open Directory Service via the drop-down list on the right in the same row. For verification purposes, a preview of the relevant records appears on the right, which you can navigate by using the appropriate buttons.

---

**INFO:** The **Unique Identifier** field must be mapped to a field in the external data source that is unique.

---

- 18) If you want to remove a row of field assignments, click on the Trash icon on the left.
- 19) Click on the **Number conversion** tab.
- 20) Select the **Active** check box.
- 21) Click on **Query System Settings**.
- 22) If the external database is located at a different site than the system:
  - a) Enter the **Country Code**.
  - b) Enter the **Local Area Code**.
  - c) Enter the **Central Office Number**.
  - d) Enter the **National Prefix**.
  - e) Enter the **National Prefix**.
  - f) Enter the **Maximum internal number length**.
- 23) Select one of the following options:
  - If you want to remove any dial-out prefix (CO code) that may be present in the external data source, select the **Remove dialout prefix** check box.
  - If you do not want to remove the dial-out prefix, clear the **Remove dialout prefix** check box.
- 24) Click **Save**.
- 25) Click **OK**.

### **Next steps**

Restart the Open Directory Service for the change to take effect.  
Preview the LDAP search result.

## 22.4.6 How to Preview LDAP Search Results for the Open Directory Service

### *Prerequisites*

- You are logged into the WBM with the **Expert** profile.

Follow these steps to check whether an LDAP search result of the Open Directory Service returns records in the desired form and with the correct number format.

### *Step by Step*

- 1) In the navigation bar, click on **Expert Mode**.
- 2) In the navigation tree, click on **Applications > Open Directory Service**.
- 3) Click in the menu tree under **Open Directory > Data Sources** on the desired data source.
- 4) Click on the **LDAP test** tab.
- 5) Click on **Run test**. The preview of the search result will appear under **LDAP Search Result**.

## 22.4.7 How to Delete an External Data Source for the Open Directory Service

### *Prerequisites*

- You are logged into the WBM with the **Expert** profile.

### *Step by Step*

- 1) In the navigation bar, click on **Expert Mode**.
- 2) In the navigation tree, click on **Applications > Open Directory Service**.
- 3) Click on **Open Directory > Data Sources** in the menu tree.
- 4) Click on the relevant data source in the workspace.
- 5) Click on **Delete**.
- 6) Click on **OK**.

### *Next steps*

Restart the Open Directory Service for the change to take effect.

## 22.5 XMPP

XMPP (Extensible Messaging and Presence Protocol) is an Internet standard for XML routing and is used mainly for instant messaging. XMPP enables the integration of external communication partners for instant messaging and the mapping between the presence status and the XMPP status.

XMPP is supported for the following clients:

- myPortal for Desktop
- myPortal for Outlook
- myAttendant

An external XMPP communication partner may be a Google Talk or Microsoft Lync Office Communicator user, for example.

The integrated Openfire XMPP server is externally addressed via port 5269 by default. The connections to other XMPP servers can be secured with TLS, provided they support TLS. Port 5222 is used to communicate internally with clients. The ports must be opened in the appropriate firewall. XMPP is disabled in the system by default and can be configured by the administrator. The required configuration of XMPP in each client can be performed by the subscriber. External XMPP gateway servers are not supported. XMPP IDs of external communication partners must conform to the pattern `xmpp:john.public@osbiz.example-for-a-domain.com` and may be present at the following locations:

- external directory
- External offline directory (LDAP)
- Personal directory (myPortal for Desktop)
- Outlook contacts (myPortal for Outlook)  
IM address field
- Favorites

---

#### Related Topics

- [Instant Messaging](#)

## 22.5.1 How to Configure XMPP

### *Prerequisites*

- The system has a connection to the Internet.
- The system can be reached on the Internet under a name, e.g., `osbiz.example-for-a-domain.com`.
- You are logged into the WBM with the **Expert** profile.

### *Step by Step*

- 1) In the navigation bar, click on **Expert Mode**.
- 2) Click in the navigation tree on **Applications > Web Services**.
- 3) In the menu tree, click on **WebServices > XMPP**.
- 4) Select the **XMPP Mode on** check box.
- 5) Select one of the following options:
  - If a standalone System is involved, select the option **XMPP Standalone**.

- If a networked system is involved, select the option **XMPP in the network**.
- 6) If a standalone system or a networked system that is not the master is involved, enter the name under which the system can be reached via the Internet in the **XMPP Domain** field in the following format: `osbiz.example-for-a-domain.com`.

---

**INFO:** Updating this data in the network can take up to 10 minutes.

---

- 7) Select one of the following options:
  - If you want to use only secure connections to other servers, select the **Secure connections (TLS) enabled** check box.
  - If you do not want to use secure connections to other servers, clear the **Secure connections (TLS) enabled** check box.
- 8) Click **Apply** followed by **OK**.

## 22.6 Application Launcher

Application Launcher is a Java-based Windows application for the call-related control of applications running on the client PCs of UC Suite users and myAgent users. Application Launcher could typically be used to automatically open the contact form in a CRM system for each respective caller, for example.

Application Launcher provides the following features:

- Obtaining call-related information on a phone number (e.g., phone number, name of the caller, customer ID) from either the Open Directory Service or from system directories
- Launching Windows applications or web applications for incoming and outgoing calls
- Transfer of call-related information to Windows applications or web applications
- Automatic operation in the background for incoming calls
- Optional, configurable screen pops for incoming calls with call-related information and buttons for user actions
- Caller list with call function
- Preview functions for testing during configuration
- System configuration profile for simple transfer of the configuration settings of the first configured client to all other clients

### 22.6.1 Prerequisites for Application Launcher

In order to use Application Launcher, the client PC of the individual user must be equipped with the appropriate hardware and software.

Local administrator rights on the client PC are required for the installation, but not for automatic updates.

### Operating System

Application Launcher can be used in combination with the following operating systems:

- Microsoft Windows 10 / 8.1 / 8 / 7 (both 32-bit or 64-bit are possible)
- Microsoft Windows Vista (32 bit)

---

**INFO:** The used operating system always requires the latest version of all available updates (Service Packs and patches).

---

### Windows Update

The PCs always need the current status of all available updates, including Service Packs.

### Additional Software

Latest Oracle Java version (see **Service Center > Software**)

### Web Services for Mobile Phones

Web services for mobile phones has been enabled in the system for the system connection. The ports configured in the system must be open in the firewalls on the LAN and the client PCs.

### Open Directory Service (optional)

If Application Launcher is to use the data from the Open Directory Service, the Open Directory Service must be configured in the system. The port configured for this in the system must be open in the firewalls on the LAN and the client PCs.

---

### Related Topics

- [Configuring myPortal to go and Mobility Entry](#)

## 22.6.2 Profile with Configuration Data for Application Launcher

A profile with configuration data for Application Launcher enables the easy and fast configuration of Application Launcher on all client PCs.

The profile contains all the configuration data, except for the system connection and the user data. As soon as Application Launcher has been fully configured for an initial user, as an administrator, you can make that profile with the Application Launcher configuration data available in the communication system. All other users can then perform the configuration of Application Launcher by importing this profile.

## 22.6.2.1 How to Provide a Profile with Configuration Data for Application Launcher

### *Prerequisites*

- Application Launcher is a fully configured for a user.
- You are logged into the WBM with the **Expert** profile.

### *Step by Step*

- 1) In the navigation bar, click on **Expert Mode**.
- 2) Click in the navigation tree on **Applications > OpenScape Application Launcher**.
- 3) Click on **Browse** and select the following file:  
C:\Documents and Settings\<<Windows User Name>\Application Data\Tray\_Tool\profile.xml.
- 4) Click on **Open**.
- 5) Click on **Load**.

### *Next steps*

All users can import this profile in Application Launcher and thus perform the configuration.

## 22.7 Circuit

It is possible for OpenScape Business mobility groups and users to use the Circuit functionality. To do that, you must configure the Circuit connectivity with OpenScape Business and add the Circuit users.

### 22.7.1 How to Configure the Circuit Connectivity

#### *Prerequisites*

- You have entered the value **Upstream up to (Kbps)** under **Setup > Wizards > Network/Internet > Internet Configuration**, in order to conduct simultaneous calls. For example, enter '256' for 2 simultaneous calls.

#### *Step by Step*

- 1) In the navigation bar, click on **Setup**.
- 2) In the navigation tree, click **Wizards > Circuit**.
- 3) Click on **Edit** next to **Circuit Connectivity**, to configure the basic connectivity settings.
- 4) Select the checkbox **Enable Circuit** to activate the Circuit connectivity.

5) Under **Circuit Domain Credentials**, enter the following details:

a) Select the **Domain** from the available drop-down list.

The following options are available:

de.circuit.com

us.yourcircuit.com

eu.yourcircuit.com

Custom

---

**INFO:** In case Custom is selected, complete the **Custom Domain** field.

---

b) In case checkbox **Use Circuit API-Key** is selected:

Insert the Api Key which is generated for your tenant.

6) Under **Simultaneous Circuit Calls**, select the number of simultaneous Circuit calls from the available drop-down list. This number depends on the upstream value previously configured.

---

**INFO:** If the call quality deteriorates, the number of simultaneous calls must be reduced.

---

7) Click **OK & Next**.

8) Click **Execute function** to proceed with the automatic configuration.

The system adds the trunks to Circuit, completes the UTC configuration and checks the connectivity.

9) When the function is executed, click **OK & Next**.

10) Click **Finish**.

---

**INFO:** It is suggested to save the configuration data, by selecting **Data Backup > Backup - Immediate** from the main menu.

---

## 22.7.2 How to Manage Circuit Users

### *Step by Step*

1) In the navigation bar, click on **Setup**.

2) In the navigation tree, click **Wizards > Circuit**.

3) Click on **Edit** next to **Circuit User Instance**.

A list with the configured Circuit users appears for the specific system.

## 22.7.2.1 How to Add Circuit Users

### *Step by Step*

- 1) In the navigation bar, click on **Setup**.
- 2) In the navigation tree, click **Wizards > Circuit**.
- 3) Click on **Edit** next to **Circuit User Instance**.
- 4) Click on **Add** next to **New Circuit User**.
- 5) At the **Circuit User Allocation** page, enter the following details:
  - a) The **trunk access code + Circuit user call number**.
  - b) The Circuit user call number.
  - c) The Circuit user DID.
  - d) The Circuit User. The available users are displayed as icons.
  - e) The Circuit user **Name** is filled automatically.
  - f) Search a Circuit user by **Name** or **E-mail**.
  - g) Select a Circuit User.

There are three types of icons for Circuit users:

Available licensed users, who are active displayed in Green color.

Non available, non licensed who are not active displayed in greyed outgreen color.

Non available, licensed users but already configured with a number inCircuit who are not active displayed in greyed out green color in redframe.

- 6) Click **OK & Next**.
- 7) Repeat steps 4- 6 to add more Circuit users.

## 22.7.2.2 How to Edit Circuit User Details

### *Step by Step*

- 1) In the navigation bar, click on **Setup**.
- 2) In the navigation tree, click **Wizards > Circuit**.
- 3) Click on **Edit** next to **Circuit User Instance**.
- 4) Click on **Edit** next to the corresponding Circuit user.
- 5) You can edit the following details:
  - a) The **trunk access code + Circuit user call number**.
  - b) The Circuit user call number.
  - c) The Circuit user DID.



d) The Circuit user **Name**.

---

**INFO:** The Selected Circuit User field which contains the e-mail address of the user is not editable.

---

6) Click **OK & Next**.

## 23 Accounting

Accounting includes the collection of call data and account codes, the transmission and display of connection data, cost control and accounting tools.

### 23.1 Connection Data

Connection data includes the collection of call data and account codes.

#### 23.1.1 Connection Data Recording

The system can log the connection data of used lines.

For every completed connection and/or every incoming connection, a connection data record is created. A separate connection data record is stored for each new connection segment (for example, as a result of transferring or forwarding to another subscriber). Internal connections are not logged.

The administrator can enable the following options for recording connection data:

- Recording on or off
- Connection duration
- Currency amounts or call charge units:  
Call charge units are converted into currency amounts based on the configurable call charge factor (currency amount per call charge unit).
- Decimal format  
Divides the currency amount by 100 to display 6 cents as 0.06, for example
- Suppress last four digits of destination numbers
- Log incoming connections
- Outgoing calls without connection:  
For example, this gives the calling party proof that the destination station did not accept the attempted call (marked with the connection duration 00:00:00). This option applies to ISDN connections and to all subscribers.
- Connection protocol  
Start logging on beginning the call
- Log MSN
- Output LCR number outgoing or dialed number incoming
  - outgoing:  
the actual call number which is sent by LCR to the PSTN
  - incoming:  
the originally dialed internal number

If call charges accrue before the call is set up (as occurs in Austria, for instance), these are recorded, irrespective of whether or not logging of outgoing calls without connection is enabled.

The system takes connections via QSIG trunks into account only if a trunk code has been configured for them.

No logging occurs for:

- premature termination of the call attempt
- unauthorized connections (LCR, Denied lists).

---

#### Related Topics

- [Account codes](#)

### 23.1.1.1 How to Enable or Disable Connection Data Recording

The **Call Detail Recording** wizard can be used to activate the recording of connection data.

#### *Prerequisites*

- You are logged in at the WBM.

#### *Step by Step*

- 1) In the navigation bar, click on **Setup**.
- 2) In the navigation tree, click on **Wizards > Central Telephony**.
- 3) Click on **Edit** to start the **Call Detail Recording** wizard.
- 4) Select one of the following options:
  - If you want to enable connection data recording, enable the check box **Activate Call Charge Recording**.
  - If you want to disable connection data recording, disable the check box **Activate Call Charge Recording**.
- 5) Click on **OK & Next** followed by **Finish**.

### 23.1.1.2 How to Activate or Deactivate Logging of the Connection Duration

#### *Prerequisites*

- You are logged into the WBM with the **Expert** profile.

#### *Step by Step*

- 1) In the navigation bar, click on **Expert Mode**.
- 2) Click **Telephony > Basic Settings** in the navigation tree.

- 3) In the menu tree, click **Basic Settings > Call Charges > Call Charges - Output Format**.
- 4) Select one of the following options:
  - If you want to activate the function, select the check box **Call Duration**.
  - If you want to deactivate the function, clear the check box **Call Duration**.
- 5) Click on **Apply** followed by **OK**.

### 23.1.1.3 How to Configure the Logging of Currency Amounts or Call Charge Units

#### *Prerequisites*

- You are logged into the WBM with the **Expert** profile.

#### *Step by Step*

- 1) In the navigation bar, click on **Expert Mode**.
- 2) Click **Telephony > Basic Settings** in the navigation tree.
- 3) In the menu tree, click **Basic Settings > Call Charges > Call Charges - Output Format**.
- 4) Select one of the following options:
  - If you want the system to log currency amounts, enable the check box **Display amounts instead of units**.
  - If you want the system to log call charge units, clear the check box **Display amounts instead of units**.
- 5) Click on **Apply**, followed by **OK**.

### 23.1.1.4 How to Configure Call Charge Factors, Currency and Computing Accuracy

#### *Prerequisites*

- You are logged into the WBM with the **Expert** profile.

#### *Step by Step*

- 1) In the navigation bar, click on **Expert Mode**.
- 2) Click **Telephony > Basic Settings** in the navigation tree.
- 3) In the menu tree, click **Basic Settings > Call Charges > Call Charges - Factors**.
- 4) For each relevant route, enter the appropriate values in the **Multiplier** and **Multi-ISDN** fields.
- 5) Enter the appropriate value in the **Currency** field at the lower end of the form.

- 6) For each relevant route with the QSIG protocol, select one of the following options in accordance with the connected communication system:
  - If currency amounts are to be received and sent, select the **Charges (Currency Amount)** check box.
  - If call charge units are to be received and sent, clear the **Charges (Currency Amount)** check box.
- 7) In each row with a route with the QSIG Protocol which receives and sends call charge units, enter a blank under **Currency**.
- 8) From the **Computing accuracy** drop-down list, select the entry **No decimal digit, 1 decimal digit, 2 decimal digits, 3 decimal digits** or **Via call charge pulse**.
- 9) Click on **Apply**, followed by **OK**.

### 23.1.1.5 How to Activate or Deactivate the Logging of the Last Four Digits

#### *Prerequisites*

- You are logged into the WBM with the **Expert** profile.

#### *Step by Step*

- 1) In the navigation bar, click on **Expert Mode**.
- 2) Click **Telephony > Basic Settings** in the navigation tree.
- 3) In the menu tree, click **Basic Settings > Call Charges > Call Charges - Output Format**.
- 4) Select one of the following options:
  - If you want to activate the function, select the check box **Last 4 digits suppressed**.
  - If you want to deactivate the function, clear the check box **Last 4 digits suppressed**.
- 5) Click on **Apply** followed by **OK**.

### 23.1.1.6 How to Enable or Disable Outgoing Call Logging without a Connection

#### *Prerequisites*

- You are logged into the WBM with the **Expert** profile.

#### *Step by Step*

- 1) In the navigation bar, click on **Expert Mode**.
- 2) Click **Telephony > Basic Settings** in the navigation tree.

- 3) In the menu tree, click **Basic Settings > Call Charges > Call Charges - Output Format**.
- 4) Select one of the following options:
  - If you want to activate the function, select the check box **Outgoing without connection**.
  - If you want to deactivate the function, clear the check box **Outgoing without connection**.
- 5) Click on **Apply** followed by **OK**.

### 23.1.1.7 How to Enable or Disable the Logging of Incoming Calls

#### *Prerequisites*

- You are logged into the WBM with the **Expert** profile.

#### *Step by Step*

- 1) In the navigation bar, click on **Expert Mode**.
- 2) Click **Telephony > Basic Settings** in the navigation tree.
- 3) In the menu tree, click **Basic Settings > Call Charges > Call Charges - Output Format**.
- 4) Select one of the following options:
  - If you want to activate the function, select the check box **Log incoming calls**.
  - If you want to deactivate the function, clear the check box **Log incoming calls**.
- 5) Click on **Apply** followed by **OK**.

### 23.1.1.8 How to Activate or Deactivate the Connection Log

#### *Prerequisites*

- You are logged into the WBM with the **Expert** profile.

#### *Step by Step*

- 1) In the navigation bar, click on **Expert Mode**.
- 2) Click **Telephony > Basic Settings** in the navigation tree.
- 3) In the menu tree, click **Basic Settings > Call Charges > Call Charges - Output Format**.
- 4) Select one of the following options:
  - If you want to activate the function, select the check box **On Ringing**.

- If you want to deactivate the function, clear the check box **On Ringing**.
- 5) Click on **Apply** followed by **OK**.

### 23.1.1.9 How to Activate or Deactivate MSN Logging

#### *Prerequisites*

- You are logged into the WBM with the **Expert** profile.

#### *Step by Step*

- 1) In the navigation bar, click on **Expert Mode**.
- 2) Click **Telephony > Basic Settings** in the navigation tree.
- 3) In the menu tree, click **Basic Settings > Call Charges > Call Charges - Output Format**.
- 4) Select one of the following options:
  - If you want to activate the function, select the check box **Output MSN**.
  - If you want to deactivate the function, clear the check box **Output MSN**.
- 5) Click on **Apply** followed by **OK**.

### 23.1.1.10 How to Activate or Deactivate the Decimal Format

#### *Prerequisites*

- You are logged into the WBM with the **Expert** profile.

#### *Step by Step*

- 1) In the navigation bar, click on **Expert Mode**.
- 2) Click **Telephony > Basic Settings** in the navigation tree.
- 3) In the menu tree, click **Basic Settings > Call Charges > Call Charges - Output Format**.
- 4) Select one of the following options:
  - If you want to activate the function, select the check box **Decimal format**.
  - If you want to deactivate the function, clear the check box **Decimal format**.
- 5) Click on **Apply** followed by **OK**.

## 23.1.2 Account codes

Account codes (ACCT) can be used to assign connection data and charges to specific projects. For this purpose, the system logs the account codes entered by users on their phones in the relevant connection data records.

ACCT is used in combination with connection data recording and is available to all subscribers.

The subscriber can enter an ACCT at the phone before or after dialing. It is not possible to dial from a client with ACCT enabled.

An ACCT entered during a conference with external stations is assigned to all participating connections and trunks.

The administrator can set whether an ACCT should be saved for redialing.

The personal directory (also called a phonebook) can save the code for the ACCT feature + an ACCT + a phone number together in one entry:

### ACCT Input Procedure

The administrator defines the ACCT input procedure in the LCR dial plan:

- **Mandatory**  
The ACCT must be entered before setting up the connection (before or after seizing a route).
- **Optional**  
The ACCT may optionally be entered before setting up the connection. IP phone clients support input during a call, including incoming calls.

### ACCT Checking Procedure

The system can check the validity of an ACCT entered for the following types:

- **List verification**  
Only predefined ACCTs are valid. After a valid ACCT has been entered, the subscriber can immediately continue dialing. The system rejects an invalid ACCT. "Incorrect entry" appears on the display and a negative confirmation tone is output.
- **Check number of characters**  
All ACCTs that are theoretically possible with the configured number of digits are valid. After a valid ACCT has been entered by the subscriber, he or she can immediately continue dialing.
- **No Check**  
The validity of the ACCT is not checked. ACCTs with less than 11 digits must be separated from the other digits dialed by the subscriber with "#". For ISDN phones, this variant always requires a 11-digit account code; otherwise, no dialing occurs.

If the subscriber determines during a connection that the assigned ACCT is not correct, he or she can enter some other ACCT. The system will overwrite the currently set account code. Connection data recording creates a connection data record after each segment. Therefore, previously completed connection segments will be identified with the old account code number.



---

#### Related Topics

- [Connection Data Recording](#)

### 23.1.2.1 How to Configure Account Codes

The **Call Detail Recording** wizard can be configured to record call charges.

#### *Prerequisites*

- You are logged in at the WBM.

#### *Step by Step*

- 1) In the navigation bar, click on **Setup**.
- 2) In the navigation tree, click on **Wizards > Central Telephony**.
- 3) Click on **Edit** to start the **Call Detail Recording** wizard.
- 4) Enter the account codes in the input fields of the **Account codes** area with the method described by the wizard.
- 5) Click on **OK & Next** followed by **Finish**.

### 23.1.2.2 How to Configure an Account Code Checking Procedure

#### *Prerequisites*

- You are logged into the WBM with the **Expert** profile.

#### *Step by Step*

- 1) In the navigation bar, click on **Expert Mode**.
- 2) Click **Telephony > Basic Settings** in the navigation tree.
- 3) In the menu tree, click **Basic Settings > Call Charges > Call Charges - Account Codes**.
- 4) In the row of the respective account code list in the **Checking procedure** drop-down list, select the desired entry: **No check**, **List check** or **Check number of characters**.
  - a) Select the desired value from the **Characters to be checked** drop-down list.
- 5) Click on **Apply**, followed by **OK**.

### 23.1.2.3 How to Activate or Deactivate Number Redial with ACCT

#### *Prerequisites*

- You are logged into the WBM with the **Expert** profile.

#### *Step by Step*

- 1) In the navigation bar, click on **Expert Mode**.
- 2) Click **Telephony > Basic Settings** in the navigation tree.
- 3) In the menu tree, click **Basic Settings > System > System Flags**.
- 4) Select one of the following options:
  - If you want to activate the function, select the check box **No. redial with a/c code**.
  - If you want to deactivate the function, clear the check box **No. redial with a/c code**.
- 5) Click on **Apply**, followed by **OK**.

## 23.2 Displaying and Transmitting Connection Data

The display and transmission of connection data includes different ways of displaying connection data on system phones and file transfer methods.

### 23.2.1 Call-Charge Display with Currency (not for U.S.)

The system can display the currency amount transmitted for the current external connection by the network provider on the display of the telephone.

The network provider must support the transfer of currency amounts with the Advice Of Charge (AOC-D or AOC-S) feature. The system aggregates the amounts of the relevant call charge units.

The currency amount can basically be transferred at the following times:

- on starting the call and possibly during the call (AOC-S)
- during the call (AOC-D)

The administrator can avoid inaccuracies in recording connection data via the "Computing accuracy" parameter. The computing accuracy determines:

- the number of decimal digits for evaluating the connection data (minimum currency amount)
- the maximum total of cumulative currency amounts.

The preset computing accuracy must equal to or higher than the computing accuracy used for ISDN. If the maximum of three decimal places is insufficient,

the system automatically rounds up the number to the next unit. Possible values for computing accuracy:

Computing accuracy	Minimum currency amount	Maximum currency amount
No decimal digits	1	around 4.3 billion
1 decimal digit	0.1	around 430 million
2 decimal digits (e.g., for Euro)	0.01	around 43 million
3 decimal digits (e.g., for British pounds sterling)	0.001	about 4.3 million

### 23.2.1.1 How to Configure the Call-Charge Display with Currency

#### *Prerequisites*

- You are logged into the WBM with the **Expert** profile.

#### *Step by Step*

- 1) In the navigation bar, click on **Expert Mode**.
- 2) Click **Telephony > Basic Settings** in the navigation tree.
- 3) In the menu tree, click **Basic Settings > Call Charges > Call Charges - Factors**.
- 4) For each desired route, from the **Advice of charge** drop-down list, select the entry **Interim**, **Final**, **Interim final** or **No charges**.
- 5) Select the number of decimal places to be taken into account in the **Computing accuracy** drop-down list at the bottom end of the form.
- 6) Click on **Apply**, followed by **OK**.

### 23.2.2 Displaying the Connection Charges on the Phone

The system can display information about the cost of an existing external connection on the phone display as a currency amount.

The system aggregates the amounts of the relevant call charge units. The currency amount is calculated from the call charge units and the configured call charge factor. The service provider must support the Advice Of Charge (AOC) feature.

The connection charges information can be transmitted at the following times:

- On starting the call and possibly during the call (AOC-S)
- During the call (AOC-D)
- At the end of the call (AOC-E)

## Accounting

### Displaying and Transmitting Connection Data

At the end of the call, the display shows the final charges for the completed call for about 5 seconds, provided the subscriber has not started some other action.

Connection charges for the current connection are always displayed when toggling.

For an unsuccessful blind transfer, the overall amount is displayed and charged.

A subscriber to whom a call is transferred will only see and be charged for the relevant amount from that point in time during the call.

## 23.2.3 Displaying the Connection Duration on the Phone

The system can show the duration of outgoing and incoming external connections on the phone's display.

The format is HH:MM:SS.

If the connection duration display is disabled, the connection charges information of the PSTN is shown on the phone's display instead. If there is no connection charges information available, the display shows the caller's number (if known).

### 23.2.3.1 How to Activate or Deactivate the Connection Duration Display

#### *Prerequisites*

- You are logged into the WBM with the **Expert** profile.

#### *Step by Step*

- 1) In the navigation bar, click on **Expert Mode**.
- 2) Click **Telephony > Basic Settings** in the navigation tree.
- 3) In the menu tree, click **Basic Settings > System > Display**.
- 4) Select one of the following options:
  - If you want to activate the function, select the check box **Call timer display**.
  - If you want to deactivate the function, clear the check box **Call timer display**.
- 5) Click on **Apply**, followed by **OK**.

## 23.2.4 Transmission of Connection Data

The system can transmit connection data in a file using HTTPS.

The transmitted file can then be evaluated with a suitable program.

A continuous output of the connection data is only possible via CSTA.

The administrator can choose between the following formats for the connection data (ASCII 8-bit):

- Compressed format
- Uncompressed format

**Compressed format, Standard**

A connection data record in compressed format contains the following fields, delimited by |, and each connection data record is terminated with CRLF:

Field position	Length	Description
1	8	Date (at end of call)
2	8	Time (at end of call)
3	3	Number of seized trunk
4	16	Internal station number
5	8	Alert time for incoming connection
6	8	Duration of the connection
7	Max. 25	Dialed or received external station number
8	11	Call charge unit/Amount
9	2	Additional information (such as incoming call, outgoing call, transferred connection, conference, DISA, connection setup charges)
10	Max. 11	Acc. code
11	Max. 11	Only for a point-to-multipoint connection: used MSN
12	6	LCR access code, CO access code
13	2	LCR route used, dial rule
14	25	Dialed or received call number (optional)

Examples of connection data records:

- **Outgoing connection:**  
 13.02.13|14:18:02|201|33388|00:02|00:00:07|0123456789||1  
 | | | | | | | |
- **Incoming connection:**  
 13.02.13|14:28:02|202|33388|00:05|00:00:12|0123456789||1  
 | | | | |

**Compressed format, USA-specific**

A connection data record in compressed format contains the following fields, delimited by |, and each connection data record is terminated with CRLF:

## Accounting

### Displaying and Transmitting Connection Data

Field position	Length	Description
1	8	Date (at end of call)
2	8	Time (at end of call)
3	3	Number of seized trunk
4	16	Internal station number
5	8	Alert time for incoming connection
6	8	Duration of the connection
7	Max. 25	Dialed or received external station number
8	11	Call charge unit/Amount
9	2	Additional information (such as incoming call, outgoing call, transferred connection, conference, DISA, connection setup charges)
10	Max. 11	Acc. code
11	Max. 11	Only for a point-to-multipoint connection: used MSN
12	6	LCR access code, CO access code
13	2	LCR route used, dial rule
14	2	PRI Nodal Service
15	1	PRI WATS band
16	3	PRI CIC
17	25	Dialed or received call number (optional)

---

**NOTICE:** In `HKEY_LOCAL_MACHINE\SOFTWARE` registry keys for *Accounting Tool*, the value of the **DateFormat DWORD** should be set to 1 for North America date format (MM.DD.YY). The default value is 0 and corresponds to European/Latin America date format (DD.MM.YY).

---

---

**INFO:** Data record of Accounting manager in compressed format are separated by the delimiter |. This can be configured only through Manager E.

---

### Uncompressed format

The uncompressed format is suitable for printing. In addition, a header and form feed are output. A connection data record in compressed format contains the following fields, delimited by |:

Field position	Character position, Length	Description
1	1-8 (8)	Date at end of connection: DD.MM.YY (DD = day: value range 01 ... 31, MM = month: value range 01 ... 12, YY = year: value range 00 ... 99)
2	9-16 (8)	Time at the end of a connection segment or an unanswered incoming call: hh:mm:ss a (hh = hours: value range 00 ... 23, mm = minutes: value range 00 ... 59, ss = seconds: value range 00 ... 59)
3	17-19 (3)	Trunk: trunk number Value range 1 ... 250
4	20-35 (16)	Station: Internal station number  For unanswered calls, this is the last station called (e.g., a hunt group, call forwarding, call forwarding—no answer). For group calls, this is the last station entered. For answered calls, the station that accepted the call is shown. A programmed SNO prefix (with networking only) is not output.  If the internal numbering was converted to a maximum 7-digit numbering plan, the converted station number is output.  The internal station number may be preceded by a max. 7-digit node number. If the total resulting from the node number and the station number is greater than seven, only the last seven digits of the number are output.
5	36-40 (5)	Call duration of an incoming connection: mm:ss (mm = minutes: value range 00 - 59, ss = seconds: value range 00 - 59)  The display occurs for all incoming calls, provided the output of the ring duration has been configured in the system. If a counter overflow occurs (duration > 59:59), "59:59" is output. A change in date or time during system operation can result in this situation.  In the case of an incoming call to a busy station, the ring duration is "00:00".
6	41-48 (8)	Duration of the connection or connection segment: hh:mm:ss (hh = hours: value range 00 ... 23, mm = minutes: value range 00 ... 59, ss = seconds: value range 00 ... 59)  If a connection has not been established for an incoming call, 8 blanks are output here. If a counter overflow occurs (duration > 23:59:59), "23:59:59" is output.
7	49-73 (25)	Dialed or received external station number (if available): nnnnnnnnnnnnnnnnnnnnnnnnnnnnnnnnnn (n = dialed or received character: value range 0 ... 9, *, #, ?)  The output occurs for incoming and outgoing calls, to the extent available. For outgoing calls, the dialed call number or, if available, the call number transmitted via COLP, is displayed. If the data protection function is enabled, the last four digits dialed are replaced by "????". If no station number information is available, 25 blanks are output.

## Accounting

### Displaying and Transmitting Connection Data

Field position	Character position, Length	Description
8	74-84 (11)	<p>Call charge units for a connection segment: dddddddddd</p> <p>(d = digit: value range 0 ... 9)</p> <p>You can select either call charge units or currency amounts. Call charge units are converted into currency amounts using the call charge factor that is defined by the administrator as the currency amount (including any applicable surcharges) per call charge unit.</p> <p>The following applies when setting the call charge factor:</p> <ul style="list-style-type: none"> <li>• With calculation detail: call charge factor = 100% + any applicable surcharge</li> <li>• Without calculation detail: call charge factor = amount/unit + any applicable surcharge</li> </ul> <p>The system records the connection charges with or without a surcharge depending on the calculation detail:</p> <p>The output always occurs whenever connection charges accrue for the connection segment (e.g., even for transferred connections).</p>
9	85-86 (2)	<p>Information element: additional information</p> <p>Value range: 0 - 9</p> <p>Meaning:</p> <ul style="list-style-type: none"> <li>• 1 = Incoming connection (Voice / 3.1 kHz Audio Call)</li> <li>• 2 = Outgoing connection (Voice / 3.1 kHz Audio Call)</li> <li>• 3 = Incoming connection (Other Services)</li> <li>• 4 = Outgoing connection (Other Services)</li> <li>• 5 = Incoming connection, routed</li> <li>• 6 = Outgoing connection, routed</li> <li>• 7 = int/ext/ext conference with incoming connection / transit through external transfer</li> <li>• 8 = Conference with outgoing connection / Transit through external transfer</li> <li>• 9 = Outgoing connection via call forwarding to external destination</li> <li>• 0 = Connection information (caller list) is output immediately on receiving an incoming call (the output can be suppressed). This can be used, for instance, for a database search from a PC. In cases where multiple stations are called, a separate line is output for each individual station (without ring duration, connection duration, call charge information).</li> <li>• +20 = Offset as a code for connection setup charges (connection setup without connection duration)</li> <li>• +30 = Offset as a code for a follow-up data record in the case of <ul style="list-style-type: none"> <li>– Call duration &gt; 24 h.</li> <li>– contiguous connection segments with the same line/station number (e.g., after transferring a connection or clearing a conference).</li> </ul> </li> <li>• +40 = Offset for a data record with transit code (by an extension in the subsystem). Can occur in combination with offset +30.</li> <li>• +50 = Offset as a code for DISA connections</li> <li>• +70 = combination of offsets +30 and +40</li> </ul>



Field position	Character position, Length	Description
10	87-97 (11)	Account code (ACCT) entered by the user for this connection: aaaaaaaaaa (a = ACCT digit: value range 0 ... 9) Missing digits are replaced by spaces.
11	98-108 (11)	Used MSN: mmmmmmmmmmm (m = digit of the MSN: value range 0 ... 9) The output occurs if the user has programmed an MSN key. For outgoing connections of a MULAP subscriber, the call number of the seized MULAP is displayed. Missing digits are replaced by spaces.
12	109-113 (5)	Seizure code used, access code: sssss (s = digit of the seizure code: value range 0 ... 9)
13	114-115 (2)	Used LCR route: rr (r = digit of the selected route: value range 0 ... 9)

### Communication Sequence

The transfer of connection data can be requested (download request), whereupon the system responds accordingly (download response).

Subsequently, the deletion of connection data can be requested (delete request), whereupon the system responds accordingly (download response).

### Download Request - Definition

Element	Contents
HTTP header	Request method = GET
URL	https://<IP address of the system>/management/portlet
Parameters	portlet=hipath-accountingdownload::HiPathAccountingDownloadPortlet
	entity=accounting
	action=get
	username = <username>
	password=<password>

---

**INFO:** When accessing charge data with the referenced interface, HTTP GET request restrictions are applied. The following special characters are not allowed to be used as password, when someone attempts to get data via URL request:  
:/?#[!@!\$&'()\*+;,;=

---

Example:

## Accounting

### Displaying and Transmitting Connection Data

```
https://192.148.108.151/management/portlet/?portlet=hipath-  
accountingdownload::HiPathAccountingDownloadPortlet&entity=  
accounting&action=get&username=xbert@system&password=not4u;  
-)
```

#### Download Response - Definition

Element	Contents
HTTP header	ContentType = "text / plain"
Parameters	attachment filename = "<charging file>"
	data = <content of the charging file>

Response Code	Meaning
SC_OK(200)	Success
SC_BAD_REQUEST(400)	Missing parameter in request
SC_UNAUTHORIZED(401)	Login failure or wrong user name or password
SC_INTERNAL_SERVER_ERROR(500)	Internal error

#### Delete Request - Definition

Element	Contents
HTTP header	Request method = POST
URL	https://<IP address of the system>/management/portlet
Parameters	portlet=hipath-accountingdownload::HiPathAccountingDownloadPortlet
	entity=accounting
	action=delete
	username = <username>
	password=<password>

Example:

```
https://192.148.108.151/management/portlet/?portlet=hipath-  
accountingdownload::HiPathAccountingDownloadPortlet&entity=  
accounting&action=delete&username=xbert@system&password=not  
4u;-)
```

### Delete Response - Definition

Response Code	Meaning
SC_OK(200)	Success
SC_BAD_REQUEST(400)	Missing parameter in request
SC_UNAUTHORIZED(401)	Login failure or wrong user name or password
SC_INTERNAL_SERVER_ERROR(500)	Internal error

---

#### Related Topics

- [Accounting Tools](#)

## 23.2.4.1 How to Select the Format

### Prerequisites

- You are logged into the WBM with the **Expert** profile.

### Step by Step

- 1) In the navigation bar, click on **Expert Mode**.
- 2) Click **Telephony > Basic Settings** in the navigation tree.
- 3) In the menu tree, click **Basic Settings > Call Charges > Call Charges - Output Format**.
- 4) Select one of the following options:
  - To select the compressed format, enable the check box **Compressed Output**.
  - To select the uncompressed format, clear the check box **Compressed Output**.
- 5) Click on **Apply**, followed by **OK**.

## 23.2.4.2 How to Enable or Disable Transmission of Connection Data via HTTPS

### Prerequisites

- You are logged into the WBM with the **Expert** profile.

### Step by Step

- 1) In the navigation bar, click on **Expert Mode**.
- 2) Click **Telephony > Basic Settings** in the navigation tree.

- 3) In the menu tree, click **Basic Settings > Call Charges > Call Charges - Output Format**.
- 4) Select one of the following options in the **Output** drop-down list:
  - If you want to enable the feature, select the item **HTTPS**.
  - If you want to disable the feature, select the item **None**.
- 5) Click on **Apply**, followed by **OK**.

## 23.3 Cost control

Cost control includes the features Expensive Connection Route Advisory and Toll Fraud Monitoring.

### 23.3.1 Expensive Connection Route Advisory

If the telephone is currently unable to reach a call destination via the least-cost routing path, it can notify the subscriber of the use of an expensive connection path via an advisory signal.

The subscriber can thus decide whether or not to conduct the call at that time despite the expensive connection path. The advisory signal may occur as follows:

- Text in the display
- Tone
- Text in the display and tone

The system issues an advisory message for the expensive connection path if a corresponding warning has been configured in the routing table and if the system is not using the route of index 1 of the routing table.

The advisory message is only displayed on the screen if no name is configured for the associated dial rule. If a name is configured, it is displayed.

#### 23.3.1.1 How to Configure an Expensive Connection Route Advisory

##### *Prerequisites*

- You are logged into the WBM with the **Expert** profile.

##### *Step by Step*

- 1) In the navigation bar, click on **Expert Mode**.
- 2) In the navigation tree, click **Telephony > LCR**.
- 3) Click **Routing > LCR > Routing table** and then on the appropriate routing table.

- 4) For every expensive connection route (**Route** column), select the desired entry from the **Warning** drop-down list: **Tone**, **Display** or **Display + Tone**.
- 5) Click on **Apply**, followed by **OK**.

## 23.3.2 Toll Fraud Monitoring

The system can monitor connections to detect possible occurrences of toll fraud. Monitoring is performed for connections that arrive via a trunk and then leave via a trunk.

The first station signals when the configured connection duration is exceeded and thus enables you to disconnect the call if required. As an administrator, you can configure whether or after what connection duration such a connection is to be signaled.

### 23.3.2.1 How to Enable or Disable Toll Fraud Monitoring

#### *Prerequisites*

- You are logged into the WBM with the **Expert** profile.

#### *Step by Step*

- 1) In the navigation bar, click on **Expert Mode**.
- 2) Click **Telephony > Basic Settings** in the navigation tree.
- 3) In the menu tree, click **Basic Settings > System > Time Parameters**.
- 4) Select one of the following options:
  - If you want to enable Toll Fraud Monitoring, select the desired entry for **Timer for Toll Fraud Monitoring** in the **Base** drop-down list and enter a value other than 255 in the **Factor** field. **Base \* Factor** is the connection duration after which a potentially fraudulent connection is signaled.
  - To disable Toll Fraud Monitoring, enter the value 255 for **Timer for Toll Fraud Monitoring** in the **Factor** field.
- 5) Click on **Apply**, followed by **OK**.

## 23.4 Accounting Tools

Accounting tools are provided by Accounting Manager and Teledata Office.

---

#### **Related Topics**

- [Service Center – Documents](#)

- [Transmission of Connection Data](#)

## 23.4.1 Accounting Manager

Accounting Manager is a Windows application for retrieving connection data via HTTPS and evaluating this data using tables and graphics.

Accounting Manager ships with its own documentation. Accounting Manager retrieves connection data from the individual network nodes. You can also use Accounting Manager to test the Connection Data interface. You can download Accounting Manager in the **Service Center** of the WBM. Accounting Manager requires local administration rights and the activation of TLS 1.2 in Microsoft Internet Explorer.

## 23.4.2 Teledata Office

Teledata Office is a Windows application for analyzing connection data.

## 24 Maintenance

The system offers several maintenance options. This includes changing the telephony settings, backing up and restoring the configuration data, updating the software with updates and upgrades and restarting/reloading functions. In addition, appropriate functions for status identification, monitoring and maintenance are available. Remote access to the system is possible via different Remote Services.

### **Maintaining the UC Booster Server**

If a UC Booster Server is being operated in addition to the communication system, several maintenance options are offered by UC Booster Server as well. To maintain the UC Booster Server, the administrator does not specify the IP address of the communication system when calling the WBM, but the IP address of the Linux server.

## 24.1 Telephony Configuration

The communication system offers various configuration options for telephony, e.g., date and time, SNTP, customized display, and Music on Hold.

### 24.1.1 Date and Time

The communication system features a system clock with date and time. This system time is shown in myPortal for Desktop and on every terminal's display.

You can define the basic system time or synchronize it as follows:

- via a time server using SNTP
- via an ISDN trunk through an outgoing call
- by a manual setting

System-specific settings are not possible for the system time after activating an SNTP server.

If ever an SNTP server cannot be reached and HFA system phones use a different time source than the system, the time displayed on the phones may differ from the system time.

A system time manually set after system startup is always overwritten by ISDN time information the first time an outgoing ISDN call is made, provided the network provider transmits this information. If the difference between the system time manually set and the ISDN time information in a live system is between 2 and 70 minutes, the ISDN time information is applied. Otherwise, the system time manually set is maintained.

The administrator can select one of the following formats to display the date on the terminal. The format is additionally dependent on the type of phone:

Date format	OpenStage	OptiPoint 410, OptiPoint 420
Europe	Tue 20.11.07	20. NOV 07
USA	Tue 11/20/07	Tue NOV 20.07
International1	Tue 20.11.07	Tue 20 NOV 07
International2	Tue 20.11.07	TUE 20.11.07

If you inadvertently set a date before 2007 as an administrator, you will subsequently no longer be able to access the WBM. This will only be possible after a restart, which resets the date to 01.01.2007.

### 24.1.1.1 How to Configure the Date and Time Manually

#### Prerequisites

- You are logged into the WBM with the **Expert** profile.

Perform the following steps if the system does not obtain the date and time via digital trunks or via SNTP.

#### Step by Step

- 1) In the navigation bar, click **Expert Mode**.
- 2) In the navigation area, click **Telephony Server > Basic Settings**.
- 3) Click **Basic Settings > Date and Time > Date and Time** in the menu tree.
- 4) Enter the **Date and Time**.
- 5) Click on **Apply**.
- 6) Click on **Log Out**.
- 7) Log into the WBM again.

### 24.1.1.2 How to Set the Time Zone

#### Prerequisites

- You are logged into the WBM with the **Expert** profile.

#### Step by Step

- 1) In the navigation bar, click **Expert Mode**.
- 2) In the navigation area, click **Telephony Server > Basic Settings**.
- 3) Click **Basic Settings > Date and Time > Timezone Settings** in the menu tree.



- 4) Select the **Time Zone** in the drop-down list.
- 5) Click on **Apply**.
- 6) Log into the WBM again.

### 24.1.1.3 How to Configure the Date Format

#### *Prerequisites*

- You are logged into the WBM with the **Expert** profile.

#### *Step by Step*

- 1) In the navigation bar, click **Expert Mode**.
- 2) In the navigation area, click **Telephony Server > Basic Settings** .
- 3) In the menu tree, click **Basic Settings > System > Display**.
- 4) Select the date format from the **Date format** drop-down list.
- 5) Click on **Apply**.

## 24.1.2 SNTP

Over SNTP, you can synchronize the date and time of your systems with NTP time servers on a network-wide basis.

SNTP (Simple Network Time Protocol) is a simplified version of NTP (Network Time Protocol), a standard for synchronizing date and time via packet-based communication networks. Your system needs a connection to an NTP server to synchronize date and time. This connection can occur in your local network or on the Internet. A number of different NTP servers are available on the Internet; you can select one that is located in your time zone. Note the conditions of use for the relevant server and, if necessary, request permission.

### 24.1.2.1 How to Obtain the Date and Time from an SNTP Server

#### *Prerequisites*

- You are logged into the WBM with the **Expert** profile.

#### *Step by Step*

- 1) In the navigation bar, click **Expert Mode**.
- 2) Click on **Telephony > Basic Settings** in the navigation tree.
- 3) Click **Basic Settings > Date and Time > SNTP Settings** in the menu tree.
- 4) Enter the **IP Address / DNS Name of External Time Server**, e.g.,  
`0.de.pool.ntp.org`.

- 5) Select the item **enabled** in the **Operating State of SNTP Server** drop-down list.
- 6) In the **Poll Interval for External Time Server** drop-down list, select the desired time interval for retrieving the correct date and time from the SNTP server.
- 7) Click on **Apply**.
- 8) Log into the WBM again.

### 24.1.3 Telephone Logos

System telephones with a display may show the logo as a background of the Telephony User Interface (TUI).

As an administrator, you can import, assign or delete phone logos for system telephones with a display. Different types of system telephones may use different phone logos.

#### 24.1.3.1 How to Load a Phone Logo into the System

##### *Prerequisites*

- You are logged into the WBM with the **Expert** profile.
- The image file with the phone logo meets the following prerequisites::

	<b>OpenStage 40</b>	<b>OpenStage 60, OpenStage 80</b>
Format	BMP	JPEG
Color	monochrome	monochrome or color
Image size (pixels)	144 x 32	240 x 71
Max. file size (bytes)	702	30k

- You have access to the image file with the phone logo in the file system of the administration PC.

##### *Step by Step*

- 1) In the navigation bar, click on **Expert Mode**.
- 2) Click **Maintenance > Software Image** in the navigation tree.
- 3) Click on **Phone Logo Images > Load** in the menu tree.
- 4) Click **Browse** to select an appropriate image file.
- 5) Click **Load**.

### 24.1.3.2 How to Deploy a Phone Logo to System Telephones

#### *Prerequisites*

- You are logged into the WBM with the **Expert** profile.

#### *Step by Step*

- 1) In the navigation bar, click on **Expert Mode**.
- 2) Click **Maintenance > Software Image** in the navigation tree.
- 3) Click on **Phone Logo Images > Deploy** in the menu tree.
- 4) Select the check box **Deploy** in the row of the phone logo to be deployed.
- 5) Select the desired system telephone type in the **Deploy to Workpoints with Selected Device Type** drop-down list.
- 6) Click on **Apply**.

### 24.1.3.3 How to Delete a Phone Logo

#### *Prerequisites*

- You are logged into the WBM with the **Expert** profile.
- You have access to the image file with the phone logo in the file system of the administration PC.

To delete a phone logo from the communication system, perform the following steps:

#### *Step by Step*

- 1) In the navigation bar, click on **Expert Mode**.
- 2) Click **Maintenance > Software Image** in the navigation tree.
- 3) Click on **Phone Logo Images > Load** in the menu tree.
- 4) Select the check box **Delete** in the row of the phone logo to be deleted.
- 5) If you want to delete more phone logos, repeat the previous step.
- 6) Click on **Delete**. All marked phone logos will be deleted from the communication system.

### 24.1.4 Customized Display

A customized display enables the company name, for example, to be displayed on system phones in the idle state.

Only the right portion (max. 18 characters) of the second display line, which displays "OpenScape" by default, can be changed. The text lines up with the left part of the date if the length of the text allows it:

```
16:30          FR 29.FEB 08          123456 Post Office Hotel>
```

### 24.1.4.1 How to Change the Customer-Specific Display (System Name)

#### *Prerequisites*

- You are logged into the WBM with the **Expert** profile.

#### *Step by Step*

- 1) In the navigation bar, click on **Expert Mode**.
- 2) Click **Telephony > Basic Settings** in the navigation tree.
- 3) Click **Basic Settings > Gateway** in the menu tree.
- 4) Enter the name to be displayed in the **System Name** field.

---

**INFO:** Do not use any characters other than A-Z, a-z and 0-9.

---

- 5) Click on **Apply** followed by **OK**.

### 24.1.5 Multilingual Text Output

The language for display messages can be selected system-wide or for a specific station only.

Available languages: Bulgarian, Catalan, Chinese, Czech, Danish, Dutch, English (UK), English (US), Estonian, Finnish, French, German, Greek, Hungarian, Italian, Latvian, Lithuanian, Macedonian, Norwegian, Polish, Portuguese, Romanian, Russian, Serbian, Serbo-Croatian, Slovak, Slovenian, Spanish, Swedish, German (Telekom), Turkish.

You set the language when you enter the country initialization code during system booting.

---

#### **Related Topics**

- [How to Configure IP and SIP Stations](#)
- [Configuring Stations](#)

### 24.1.6 Flexible Menus

Flexible menus allow you to customize the menu items shown on the display of system telephones.

As an administrator, you can select the menu items to be shown or hidden individually.

### 24.1.6.1 How to Edit the Flexible Menu

#### *Prerequisites*

- You are logged into the WBM with the **Expert** profile.

#### *Step by Step*

- 1) In the navigation bar, click on **Expert Mode**.
- 2) Click **Telephony > Basic Settings** in the navigation tree.
- 3) In the menu tree, click **Basic Settings > System > Flexible menu**.
- 4) Edit the **Masking list** as follows:
  - To hide a menu item, enable its check box.
  - To show a menu item, enable its check box.
- 5) Click on **Apply** followed by **OK**.

### 24.1.7 Music on Hold

The communication system can play back Music on Hold (MOH) to waiting subscribers during switching operations. Callers hear MOH while in the hold state, parked state or transfer state. This also applies to callers in the call distribution queue.

The system can import Music On Hold from the following sources:

- Music On Hold
- Xpressions Compact (IVM)  
See the documentation of Xpressions Compact. For configuration, see IVM in the documentation of Manager E.
- EXMR  
See Installing OpenScape Business X1, Service Documentation or Installing OpenScape Business X3/X5/X8, Service Documentation.
- MUSIC plugin module  
See Installing OpenScape Business X1, Service Documentation or Installing OpenScape Business X3/X5/X8, Service Documentation.
- MPPI USB EXM module (only for OpenScape Business X3/X5)  
See Installing OpenScape Business X3/X5/X8, Service Documentation.

#### **Audio Files**

The administrator can transfer audio files for the internal Music on Hold from the PC to the communication system for use as an alternative internal Music on Hold.

---

**INFO:** Before using announcements or music from other sources, make sure that you do not infringe on any copyrights.

---

---

**IMPORTANT:** If the station on hold is an IP workpoint client or an IP trunk, the internal MOH is used. External MOH is not intended for IP.

---

The audio files must be available as `wave` files with the following properties:

- 16 bit PCM
- Mono or stereo
- Possible sample rates: 8 / 22.05 / 24 / 32 / 40 / 44.1 or 48 kHz.
- Maximum length for the audio file name: 30 characters

Recommended: **16 bit PCM - Mono - 8 kHz, length approx 2 min**

### **Music On Hold**

Different Music on Hold can be configured for the day and night service.

The administrator can configure the following functions:

- Music on hold with ringing tone (ringback):  
The subscriber on hold first hears the MOH melody during the consultation. After the party on hold is transferred to the destination, the ring tone is heard instead of the music on hold.
- Music on hold without ringing tone (ringback):  
The held party will hear MOH until the called party answers the call.
- No music on hold:  
The held party hears nothing (silence). The caller hears the ringback tone in the event of an unscreened transfer for an external call.

## **24.1.7.1 How to Import Internal Music On Hold**

The **Music on Hold / Announcements** wizard can be used to import audio files as internal Music on Hold in the communication system.

### **Prerequisites**

- You are logged in at the WBM.
- The audio files to be imported are available as WAVE files in the required format.

---

**INFO:** Before using announcements or music, make sure that you do not infringe on any copyrights.

---

### *Step by Step*

- 1) In the navigation bar, click on **Setup**.
- 2) In the navigation tree, click on **Wizards > Central Telephony**.
- 3) Click **Edit** to start the **Music on Hold / Announcements** wizard.
- 4) Go to **MoH Day File** for the day service or **MoH Night File** for the night service and click on **Browse**.
- 5) Select an audio file and click **Open**. The path to the audio file is displayed at **MoH Day File** and/or **MoH Night File**.
- 6) Click on **Load**.
- 7) Confirm the message with **OK** and click **OK & Next**.
- 8) Click **Finish**.

## 24.1.7.2 How to Configure the Music on Hold Functionality

### *Prerequisites*

- You are logged into the WBM with the **Expert** profile.
- The maximum length for the Music on Hold file name is 30 characters.

### *Step by Step*

- 1) In the navigation bar, click on **Expert Mode**.
- 2) Click on **Telephony > Auxiliary Equipment** in the navigation tree.
- 3) Click on **Auxiliary Equipment > Announcements / Music On Hold** in the menu tree.
- 4) In the **Music On Hold** area under the **Type of MOH** drop-down list, select the item **No Music On Hold**, **MOH without ringing tone** or **MOH with ringing tone**.
- 5) Click on **Apply**, followed by **OK**.

## 24.1.7.3 How to Change the Music on Hold Functionality for Each CON Group

### *Step by Step*

- 1) In the navigation bar, click on **Expert Mode**.
- 2) Click on **Telephony > Auxiliary Equipment** in the navigation tree.
- 3) Click on **Auxiliary Equipment > Announcements / Music on Hold** in the menu tree.
- 4) Click on the **Edit Music On Hold** tab.
- 5) Select the desired music on hold from the Audio File drop-down list in the relevant row of the traffic restriction group.

- 6) If a CON group does not have any music on hold assigned to it, the internal music on hold is used for the group
- 7) Enter a Description in the row of the corresponding traffic restriction group.
- 8) Click **Apply**.
- 9) Click **OK**.

---

**INFO:** This functionality is applicable only to OpenScape Business S systems and is not supported in OpenScape Business X.

---

## 24.1.8 Announcements

The communication system allows on-hold announcements to be played for callers before answering a call and also when using call distribution and DTMF direct inward dialing. You can also replace the MOH melody in certain situations by an announcement, for example, if a party is placed on hold or if a subscriber is busy or being routed.

The system can import announcements from the following sources:

- Internal announcements
- Announcement Player (only with UC Booster functionality)  
The announcement player is an internal software program that is available together with the UC Booster functionality (UC Booster Card or UC Booster Server). On calling a subscriber, the announcement player first plays the desired announcement and then sets up the connection to the subscriber. Manager E is required for the configuration.
- Analog Announcement Device  
See the section on Auxiliary Equipment - Analog Announcement Device in the OpenScape Business Administrator Documentation.
- MPPI USB EXM module (only for OpenScape Business X3/X5)  
See Installing OpenScape Business X3/X5/X8, Service Documentation.

The administrator can configure announcements for single (start/stop) or continuous playback.

---

**INFO:** In embedded systems continuous mode is not supported.

---

An external announcement device must behave like a station, i.e., announce itself, play the announcement and switch the call (enter consultation hold, dial and hang up).

### Audio Files

The administrator can transfer audio files with announcements from the PC to the communication system.



---

**INFO:** Before using announcements or music from other sources, make sure that you do not infringe on any copyrights.

---

The audio files must be available as `Wave` files with the following properties:

- 16 bit PCM
- Mono or stereo
- Possible sample rates: 8 / 22.05 / 24 / 32 / 40 / 44.1 or 48 kHz.
- Maximum length for the audio file name: 30 characters

Recommended: **16 bit PCM - Mono - 8 kHz, length approx 2 min**

### 24.1.8.1 How to Configure Announcements (UC Smart)

The configuration is done in Manager E according to the following basic procedure (see also the online help for Manager E):

#### *Step by Step*

- 1) Go to **System View**, menu **Settings > Set up station > Station** and set the **Type** to **Standard** for the desired port of the voicemail box (UC Smart). It is recommended to use the last ports for this purpose.
- 2) Remove the desired port from the hunt group of the voicemail box (UC Smart) under **System View**, menu **Settings > Incoming calls > Groups/Hunt groups**.
- 3) Assign a voicemail box to the call number of the corresponding port under **System View**, menu **Settings > Auxiliary Equipment > EVM**.
- 4) Select a greeting and import the announcement under **Maintenance > Announcement > Announcement equipment**.
- 5) Select single or repeated playback under **System View**, menu **Settings > Auxiliary Equipment > Announcement**, area **Announcement equipment**.

### 24.1.8.2 How to Configure Announcements (UC Suite)

The **Music on Hold / Announcements** wizard can be used to transfer audio files to the communication system and configure them as announcements.

#### *Prerequisites*

- You are logged in at the WBM.
- The audio files to be loaded are available as PCM files with the following properties: 8 kHz, 16 bit, Mono. The maximum length for the audio file name is 30 characters.

---

**INFO:** Before using announcements or music, make sure that you do not infringe on any copyrights.

---

### **Step by Step**

- 1) In the navigation bar, click on **Setup**.
- 2) In the navigation tree, click **Wizards > Central Telephony**.
- 3) Click on **Edit** to start the **Music on Hold / Announcements** wizard.
- 4) Skip the selection of the Music on Hold files and click on **OK & Next**.
- 5) To transfer an audio file to the communication system, proceed as follows:
  - a) Click on **Browse**.
  - b) Select an audio file.
  - c) Click on **Open**.
  - d) Click on **Load**.
  - e) Confirm the message with **OK**.
  - f) If you want to transfer more audio files to the system, repeat these steps.
- 6) Click on **OK & Next**.
- 7) Select an announcement from the **Wave File** drop-down list.
- 8) Select the type of playback from the **Mode** drop-down list.
- 9) Click on **OK & Next** followed by **Finish**.

## **24.1.8.3 How to Configure the Announcement Player (only with UC Booster)**

### **Prerequisites**

- The Manager E is started.
- The audio files to be loaded are available as PCM files with the following properties: 8 kHz, 16 bit, Mono. The maximum length for the audio file name is 30 characters.

---

**INFO:** Before using announcements or music, make sure that you do not infringe on any copyrights.

---

### **Step by Step**

- 1) Download the CDB of the communication system into Manager E (see [How to Load the CDB into Manager E](#)).
- 2) Click in the system view on **Settings > System Parameters**.
- 3) Click on the **System Settings** tab.

- 4) In the **AP Access Callnumber** area, click on **Set AP access**.
- 5) Under **Route**, select the entry **UC Suite** or **VSL** and enter the call number for the announcement player (e.g., 898) under **Call no..** This call number must then be specified in the call forwarding. After completing this, confirm with **OK**.
- 6) Click on **Apply**.
- 7) Click in the system view on **Settings > Least Cost Routing**.
- 8) Click on the **Dial Plan** tab.
- 9) Check the list item **Ann-Player**:

The screenshot shows the 'Least cost routing' configuration window. The left sidebar shows the navigation tree with 'Least cost routing...' selected. The main window has tabs for 'Flags and COS', 'Dial plan', and 'LCR - schedule'. The 'Dial plan' tab is active, showing a 'Digit analysis wizard' table. The table has columns: Name, Dialed digits, Route table, Acc. code, COS, and Emergency. Row 35, 'Ann-Player', is highlighted in blue and has a red box around its 'Dialed digits' field containing '-898' and its 'Route table' field containing '12'. Below this is a 'Dialing rules table' with columns: Route, Dial rule, min. COS, Schedule, and Warning. Row 1 is highlighted in blue and has a red box around its 'Dial rule' field containing '4 MEB'. At the bottom right, there are 'Reset', 'Apply', and 'Help' buttons.

Name	Dialed digits	Route table	Acc. code	COS	Emergency	
28	Standard	858CZ	10	No	yes	No
29	Standard	858C1Z	11	No	yes	No
30	Standard	858CNZ	11	No	yes	No
31	Appl-Suite	-899	12	No	yes	No
32	Standard	88CZ	1	No	yes	No
33	IP-Network	-Z	13	No	No	No
34	COInternat	0C0049-Z	14	No	yes	No
35	Ann-Player	-898	12	No	yes	No
36		-	-	No	yes	No
37		-	-	No	yes	No
38		-	-	No	yes	No

Route	Dial rule	min. COS	Schedule	Warning		
1	VSL	4	MEB	5	-	None
2	-	-	-	15	-	None
3	-	-	-	15	-	None
4	-	-	-	15	-	None

- a) For the name **Ann-Player**, under **Dialed digits**, there should be a minus sign followed by the previously entered call number (e.g., -898).
  - b) The associated **Routing Table** must be set to 12 with the entries **UC Suite** or **VSL** for **Route** and **MEB** for **Dial Rule**.
- 10) Click in the system view on **Settings > Auxiliary Equipment**.
  - 11) Click on the **Announcement** tab.
  - 12) Set the announcement player as an external destination:

**Maintenance**  
Telephony Configuration

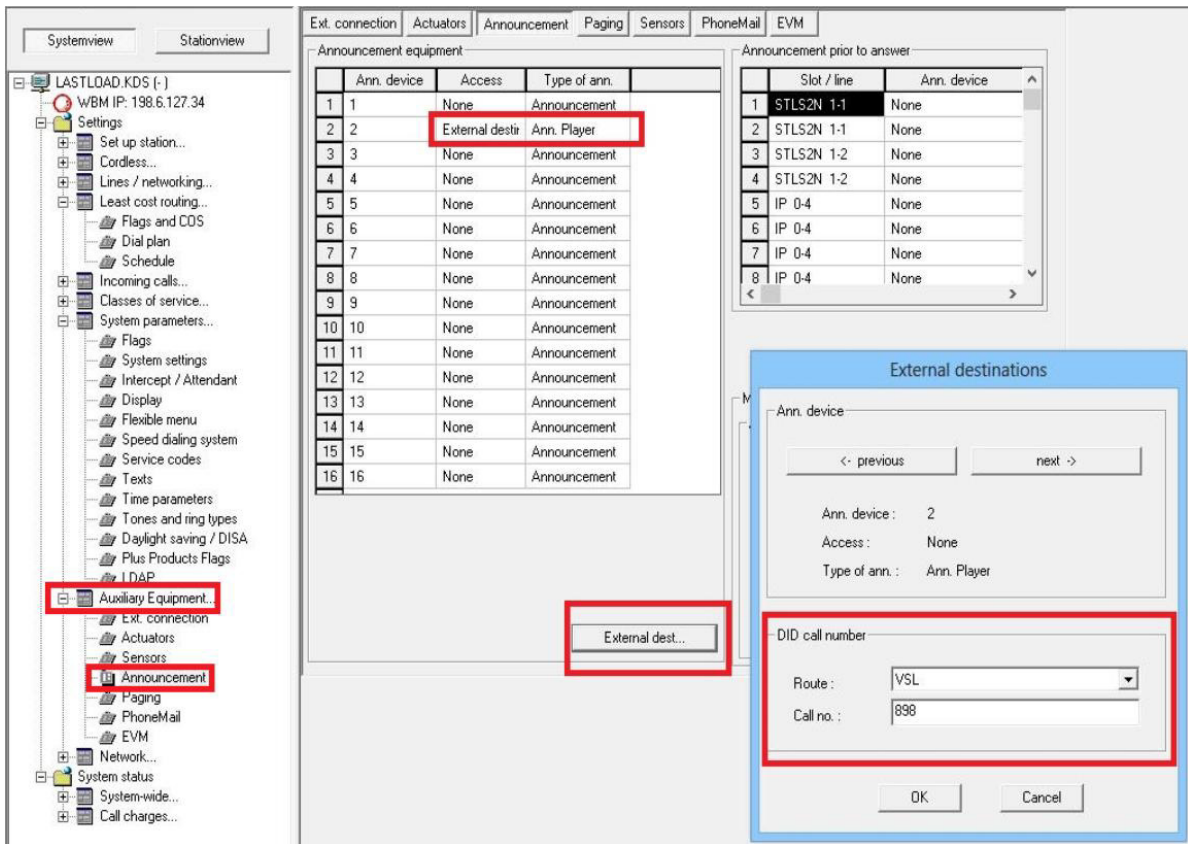

- a) Select in a list item from 2 (row 1 must not be changed - it is used for the internal Music on Hold) under **Access** the entry **External destination** and under **Type of ann.** the entry **Announcement Player**.
- b) If you want to set up further announcements, repeat the previous step and edit more list entries.
- c) Click on the **External destinations** button.
- d) Under **Route**, select the entry **UC Suite** and enter the call number for the announcement player (e.g., 898) under **Call no.** After completing this, confirm with **OK**.

**13)** Click on **Apply**.

**14)** Save the CDB back to the communication system.

**15)** Log into the WBM with the **Expert** profile.

**16)** In the navigation bar, click on **Setup**.

**17)** In the navigation tree, click on **Wizards > Central Telephony**.

**18)** Click on **Edit** to start the **Music on Hold / Announcements** wizard.

**19)** Skip the selection of the Music on Hold files and click on **OK & Next**.

**20)** To transfer an audio file to the communication system, proceed as follows:

- a) Click on **Browse**.

- b) Select an audio file.
  - c) Click on **Open**.
  - d) Click on **Load**.
  - e) Confirm the message with **OK**.
  - f) If you want to transfer more audio files to the system, repeat these steps.
- 21) Click on **OK & Next**.
- 22) For the access **External destination**, select an announcement in the **Wave File** drop-down list and then select the type of playback from the **Mode** drop-down list.

---

**INFO:** In embedded systems continuous mode is not supported.

---

- 23) If you want to set up more announcements, repeat the previous step.
- 24) Click on **OK & Next** followed by **Finish**.
- 25) In the navigation bar, click on **Expert Mode**.
- 26) In the navigation tree, click **Middleware**.
- 27) Navigate in the menu tree to **Middleware > Announcement Player**.
- 28) Click on the **Announcement player settings** tab.
- 29) Select the check box **Service will be started automatically**.
- 30) Click on **Apply**.
- 31) In the navigation tree, click on **Telephony > Incoming Calls**.
- 32) Navigate in the menu tree to **Incoming Calls > Call Forwarding**.
- 33) Click on the **Call dest. list - Definition** tab.
- 34) Select a free call destination list (e.g., call destination list 1).
- 35) Under **Target 1**, select one of the configured announcements (e.g., #802 Ans). Displaying all entries may take some time.
- 36) Under **Target 2**, select the entry **Called station**.
- 37) Click on **Apply** followed by **OK**.
- 38) Click on the **Call dest. list - Assignment** tab.
- 39) In the row of the desired subscriber, select the previously-defined call destination list (e.g., call dest. list 1) in the **Day**, **Night** and **Internal** drop-down lists.
- 40) Repeat the previous step for the other subscribers.
- On calling a subscriber to whom call destination list 1 is assigned, the announcement player first plays the configured announcement and then sets up the connection to the subscriber.
- 41) Click on **Apply**.

## 24.1.9 User to User Signaling

The communication system enables the transparent transmission of messages between stations (user to user signaling, UUS). UUS1 is supported for information exchange in control messages for connection setup and teardown.

In the case of a point-to-multipoint connection, it is important to ensure that only one device transmits a message to an incoming call.

## 24.1.10 Voice Channel Signaling Security

The communication system offers a security mechanism that can be set up by the administrator to prevent undesirable tone injections into the voice channel. No override is possible for a connection protected by this method. Every station configured as a Fax device automatically has this signaling security mechanism.

Recalls are deferred until the extension is free again.

Stations on-hold always have signaling security.

## 24.1.11 Time Parameters

The communication system offers the administrator options for setting various time parameters such as the "length of callback" or the "timer for automatic redial".

The time parameters are preset in the communication system and should normally not be changed.

## 24.1.12 Controlling Centrex Features

To control Centrex features, the dial tones for \* and # must be transmitted to the ISDN and ITSP.

As an administrator, you can activate or deactivate this feature.

The input of a code must occur in the dialing state (e.g., after entering the trunk code). The input always begins with \* or #, followed by a digit or digit combination, and ends with #.

### 24.1.12.1 How to Enable or Disable the Control of Centrex Features

#### *Prerequisites*

- You are logged into the WBM with the **Expert** profile.

### Step by Step

- 1) In the navigation bar, click on **Expert Mode**.
- 2) Click **Telephony > Basic Settings** in the navigation tree.
- 3) Navigate in the menu tree to **System > System Flags**.
- 4) Select one of the following options:
  - If you want to enable the control of Centrex features, select the check box **Transparent dialing of \* and # on trunk interfaces**.
  - If you want to disable the control of Centrex features, clear the check box **Transparent dialing of \* and # on trunk interfaces**.
- 5) Click on **Apply** followed by **OK**.

## 24.2 Backup and Restore

The communication system's configuration data can be backed up and restored.

The configuration data is saved in a backup set. Every backup creates a separate backup set. Backups can be created manually immediately or scheduled for automatic execution at specific times.

---

**INFO:** It is strongly recommended to regularly back up the configuration data as backup sets.

When updating to a new minor release, it is necessary to create a new backup set.

---

Different backup media can be used to store the backup sets (such as USB media, network drives or the hard disk of the UC Booster Card, for example).

Depending on the system configuration, the use of the communication system and the type of backup medium involved, a backup or restore may take a long time - in some cases for systems with the UC Suite, up to three hours. This process should not be terminated manually or by a system reboot.

Aborting a data recovery may lead to an inconsistent system configuration in which an error-free operation of the system is not guaranteed. An aborted recovery should always be repeated until it is completed successfully. Otherwise, a complete reconfiguration of the system may be necessary. If the recovery fails repeatedly, please contact the Service Support and make sure in the meantime that your backup is not overwritten by new backups. To do this, the automatic data backup must be temporarily disabled.

### Backup Sets for Diagnostic Purposes

"Smaller" backup sets containing diagnostic data for Service Support can be created for diagnostic purposes. In contrast to normal backup sets, significantly smaller data amounts are produced for this purpose and can thus be easily sent with an e-mail, for example. Diagnostics backup sets include, among other things,

the configuration data of the communication system and the installed UC solution. Voicemails, fax messages and announcements are not included.

#### **"Hard Disk" Backup Directory (Only for UC Booster Card)**

If a UC Booster Card is installed, the configuration data of the communication system can be saved in a separate partition on the hard disk of the UC Booster Card in the backup directory. This backup directory is already provided as the standard archive "Hard Disk".

#### **Backing up the Configuration Data of the UC Booster Server**

If a UC Booster Server is being operated in addition to the communication system, then the configuration data of the UC Booster Server must also be backed up when backing up the configuration data of the system. Backing up the data of the UC Booster Server is basically identical to backing up the data of the communication system; the only difference is that the administrator does not specify the IP address of the communication system when calling the WBM, but the IP address of the Linux server.

## **24.2.1 Backup Sets**

The configuration data of the communication system is saved in a backup set.

In addition to backup set, a text file associated with the backup set must also be saved. It contains information about the date and time of the backup and under which software version the backup was performed. The text file is necessary for the recovery of the backup set.

If the number of backup sets saved exceeds the set value, the oldest backup sets are deleted.

#### **Backup Set Data**

The following data for a backup set is presented:

- **Archive name:** Name of the backup set
- **Size:** Size of the backup set in bytes
- **Date:** Date on which the backup set was created.
- **Comment:** Comment that was specified when creating the backup set (optional).

Backup sets that have been grayed out cannot be restored.

### **24.2.1.1 How to Display Backup Sets**

#### ***Prerequisites***

- You are logged on to the WBM with the **Advanced** profile.



### Step by Step

- 1) Click on **Backup and Restore** in the navigation bar.
- 2) Click **Backup Sets** in the navigation tree.
- 3) Activate the backup medium containing the backup set you want to have displayed in the **Devices** area. A list of all backup sets available on this medium appears.

Device	Server address	Path	Login name	Max. backup sets
<input type="radio"/> (S)FTP	192.168.1.30	/backup	admin_user	10
<input type="checkbox"/> Network drive	192.168.1.20	backup	admin_user	5
<input checked="" type="radio"/> HTTPS	-	-	-	1

Archive name	Size	Date	Comment
BackupSet_2013_01_11.tar	548352	2013-01-11 11:28:23	Complete Backup

## 24.2.1.2 How to Delete Backup Sets

### Prerequisites

- You are logged on to the WBM with the **Advanced** profile.

### Step by Step

- 1) Click on **Backup and Restore** in the navigation bar.
- 2) Click **Backup Sets** in the navigation tree.
- 3) Activate the backup medium containing the backup set you want to have displayed in the **Devices** area. A list of all backup sets available on this medium appears.
- 4) Select the check box of the backup set you want to delete and click **Delete**. The backup set is deleted.

## 24.2.2 Backup Media

The backup sets are stored on the selected backup media.

The following backup media can be used for the backup:

- Inserted USB storage device
- Network drive
- Client PC using HTTP (only possible with immediate backup)
- Hard disk of the UC Booster Card
- FTP/FTPS servers

For every backup medium, the maximum number of backup sets to be stored in the directory can be specified.

### USB Storage Device

To use a USB storage device (e.g., a USB hard disk or flash drive) for backup, the USB device must be plugged into the USB server port of the communication system. In addition, the USB device must be formatted with FAT-32. USB media formatted with NTFS are read-only. Note that if multiple partitions exist, only the first partition can be used for the backup!

A bootable USB device is not supported.

With OpenScape Business S and OpenScape UC Booster Server, the USB device is plugged into the USB port of the Linux server.

### FTP/FTPS servers and network drives

FTP/FTPS servers and network drives can be added, edited or deleted as new media. FTP/FTPS servers and network drives may also be specified more than once if different directories on them are used. TLS 1.2 is supported as the encrypted file transfer protocol (FTPS).

In order to back up the configuration data, the user must have write permission for the root directory of an FTP/FTPS server. To back up to a network drive, users only need write permission for the desired directory.

If the transmission speed to the FTPS server is too low, there may be a malfunction in the backup. If this occurs, the backup must be restarted.

For FTPS, certificates up to 2048 bits are supported. These certificates are required for authentication at the FTPS server.

## 24.2.2.1 How to Add a Backup Medium

### Prerequisites

- You are logged on to the WBM with the **Advanced** profile.

### Step by Step

- 1) Click on **Backup and Restore** in the navigation bar.
- 2) Click **Set up Devices** in the navigation tree.
- 3) Click on **Add**.

The screenshot shows the 'Edit Devices' configuration page. On the left is a navigation tree with 'Set up Devices' highlighted. The main area contains the following fields:

Device	Network drive
Server address	192.168.1.20
Path	\backup
Login name	admin_user
Password	••••
Max. backup sets	5

- 4) Select the desired backup medium from the drop-down list in the **Device** column.
  - If you want to save to an FTP/FTPS server, select **(S)FTP**.
  - If you want to save to a network drive, select **Network drive**.
- 5) Enter the host name or the IP address of the medium under **Server Address**.
- 6) Enter the path in which the backup set is to be stored under **Directory**.
- 7) If you want to save to an FTP/FTPS server, enter the **User name** and **Password** for accessing the FTP/FTPS server.
- 8) If you want to save to a network drive, enter the **User Name** and **Password** for accessing the network drive.
- 9) Under **max. Backup Sets**, enter the maximum number of backup sets that are to be stored in the directory.
- 10) Click on **OK & Next**. The new backup medium created appears in the list of available backup media.
- 11) Click **Backup Sets** in the navigation tree.
- 12) Activate the backup medium you just added in the **Devices** area. If no red bar with an error message appears in the list of available backup sets, the backup medium is set up correctly.
- 13) If an error message is displayed, check your entries again (see [How to Edit a Backup Medium](#))

## 24.2.2.2 How to Edit a Backup Medium

### Prerequisites

- You are logged on to the WBM with the **Advanced** profile.

### Step by Step

- 1) Click on **Backup and Restore** in the navigation bar.
- 2) Click **Set up Devices** in the navigation tree.
- 3) Activate the backup medium to be edited and click **Edit**.

Device	Network drive
Server address	192.168.1.20
Path	\backup
Login name	admin_user
Password	••••
Max. backup sets	5

- 4) Change the required values.
- 5) Click on **OK & Next**.

### 24.2.2.3 How to Delete a Backup Medium

#### *Prerequisites*

- You are logged on to the WBM with the **Advanced** profile.

#### *Step by Step*

- 1) Click on **Backup and Restore** in the navigation bar.
- 2) Click **Set up Devices** in the navigation tree.
- 3) Select the backup medium to be deleted and click **Delete**.  
It is also possible to select multiple backup media for deletion.
- 4) Confirm the prompt with **OK**. The backup medium is deleted from the list of available backup media.

### 24.2.3 Immediate Backup

The configuration data can be immediately backed up manually.

A variety of backup media can be used for data backup; By default, the backup medium is set up as **HTTPS**. You can thus store the backup set in all storage locations that can be accessed on the client PC with which you logged into the WBM. The chosen storage location must also be accessible when restoring the backup set. If a USB device is connected to the communication system, **USB Device** is displayed as an additional backup medium. If the UC Booster Card (incl. hard disk) is connected, a further backup medium called **Local hard disk** is displayed.

The name of the backup set is assigned automatically during the backup. It includes, among other things, the date on which the backup was performed. In addition, this data is also included in a text file that must also be stored. If desired, a comment can be optionally added to identify a backup set more easily prior to a subsequent restore.

#### 24.2.3.1 How to Save a Backup Set Immediately

#### *Prerequisites*

- You are logged on to the WBM with the **Advanced** profile.
- Only when using UC Suite: UC Suite has started correctly.

#### *Step by Step*

- 1) Click on **Backup and Restore** in the navigation bar.
- 2) In the navigation tree, click **Backup - Immediate**.

Device	Server address	Path	Login name	Max. backup sets
<input checked="" type="radio"/> HTTPS	-	-	-	-
<input type="radio"/> (S)FTP	192.168.1.30	/backup	admin_user	10
<input type="radio"/> Network drive	192.168.1.20	backup	admin_user	5

- 3) Enter a comment for the backup set in the **Comment** field so that the backup set can be easily identified if needed later for a restore. Avoid the use of diacritical characters such as umlauts and special characters in your input.
- 4) If you want to create a backup set including voice messages and announcements, select the **Full Backup** option.
- 5) If you want to create a backup set without voice messages and announcements, select the **Only Diagnostics Data** option.
- 6) Activate the target drive on which the backup set is to be saved in the **Devices** area.
- 7) Click on **OK & Next**. The progress of the backup process is displayed in a separate window.

---

**INFO:** If the **OK & Next** button is grayed out, then one or more applications (e.g., UC Suite) for which the data is to be saved were not started correctly.

If you do not have access rights for the selected archive directory, you will receive an error message. Select another destination drive or change the path for the archive.

An error message appears if there is not enough disk space on the destination drive for the backup set. If this occurs, select another destination drive or delete a backup set and restart the backup.

---

- 8) The backup was successful if the message **Backup completed successfully! 100%** appears.
- 9) If you have selected **HTTPS** as a backup medium, you must save the backup set and the text file associated with the backup to a location of your choice. This is done automatically for the other backup media. The browser window must remain open until the save operation for the backup set and text file has been completed.

---

**INFO:** If you are using a USB device as a backup medium, wait till the LED of the USB device stops flashing. It is only then that the backup has been successfully stored on the USB device. You can then remove the USB device.

---

10) Click on **Finish**.

## 24.2.4 Scheduled Backup

You can use a schedule to automatically back up configuration data. The time, frequency and location of the automatic backup is configurable.

The scheduled data backup can be scheduled for a fixed time daily or weekly and then started automatically. This "backup job" can be created for an internal or external backup medium. It is not possible to configure multiple backup jobs.

### 24.2.4.1 How to Save a Backup Set with a Scheduled Backup

#### Prerequisites

- You are logged on to the WBM with the **Advanced** profile.

#### Step by Step

- 1) Click on **Backup and Restore** in the navigation bar.
- 2) In the navigation tree, click **Scheduled Backup**.

Device	Server address	Path	Login name	Max. backup sets
(S)FTP	192.168.1.30	/backup	admin_user	10
Network drive	192.168.1.20	backup	admin_user	5

- 3) Enter a comment for the backup set in the **Create backup set** area in the **Comment** field so that the backup set can be easily identified if needed later for a restore. Avoid the use of diacritical characters such as umlauts and special characters in your input.
- 4) Specify the interval for the backup:
  - Daily backup: In the **Interval** drop-down list, select the item **Daily** and then enter when the backup is to be started every day under **Backup on**.
  - Weekly backup: In the **Interval** drop-down list, select the item **Weekly** and then enter on which weekday and at what time the backup is to be started under **Backup on**.
- 5) Activate the target drive on which the backup set is to be saved in the **Devices** area.
- 6) Click on **OK & Next**. The backup is started automatically every day (daily) or every week (weekly) at the specified time.

## 24.2.5 Restore

The restoration of configuration data must be performed manually using the backup sets.

All the supported backup media can be used to restore data;

### 24.2.5.1 How to Restore a Backup Set

#### Prerequisites

- You are logged on to the WBM with the **Advanced** profile.
- Only when using UC Suite: UC Suite has started correctly.

#### Step by Step

- 1) Click on **Backup and Restore** in the navigation bar.
- 2) Click **Restore** in the navigation tree.

Device	Server address	Path	Login name	Max. backup sets
(S)FTP	192.168.1.30	/backup	admin_user	10
Network drive	192.168.1.20	backup	admin_user	5
HTTPS	-	-	-	1

Archive name	Size	Date	Comment
List of available backup sets			

**Important Notes**  
After the Restore, the system will automatically restart!

- 3) Activate the medium containing the backup set to be restored in the **Devices** area.
- 4) If you activated **HTTPS** as the backup medium, navigate to the storage location of the backup set and select the backup set. Then navigate to the storage location of the text file and select it.
- 5) If you activated any other backup medium than **HTTPS**, select the backup set containing the configuration data to be restored in the **List of available backup sets** area.
- 6) Wait until the files have been loaded onto the system and then click **OK & Next**. The recovery of the configuration data is started. The progress of the restore process is displayed.
- 7) After the message **Restore complete!** appears, the system will automatically reboot. The restoration is completed successfully when the system is ready for use again.

## 24.3 Updates

Updates provide the latest software available for the system components within a version.

To install updates, you will need the 3-year software support.

The version of the installed software and the expiration date of the software support are displayed on the home page of the WBM. If more recent software updates are available, this is indicated there.

---

**INFO:** When updating to a new minor release, it is necessary to create a new backup set.

---

The software update is performed using the WBM. On a hardware model, the software can also be optionally updated directly from a USB device without WBM access. In a communication system with the UC Booster Server, the hardware model and the UC Booster Server are updated separately.

Using the WBM, the software can be updated via the Internet web server, a local web server or directly via image files.

The following system components are updated:

- Software of the communication system
- Software of the UC clients
- Software for system telephones (updates can also be performed individually)
- Documentation

The software for the UC clients is updated together with the software of the communication system. If a more recent software version is available, users of the UC clients are notified via an Auto-Update message that an update is available and can be installed.

The software update of the IP system telephones occurs automatically with the update of the communication system, but can also be done manually. For UP0 system telephones, the update is performed manually using Manager E.

The software update can be optionally started immediately or by defining the times for the software transfer and software activation independently. The update should be performed outside the business hours of the customer, since the communication system and/or the system telephones are restarted, existing calls are dropped, and the use of the UC clients is interrupted temporarily.

After the software has been transferred to the communication system, it is activated at the selected time. The latest phone image is then automatically loaded onto the IP system telephones. After a restart of the communication system and the IP system telephones, the newly loaded software will be active.

---

**INFO:** Software update must not be performed simultaneously in all systems and in different software versions.

---



## Image Files

To update system components, compressed image files containing the software of the system components are required. These image files can be downloaded from the software server (Internet web server) and stored independently on a local web server or in the internal network or on a USB stick, for example. There is a separate image file for the communication system without a UC Booster Card and a separate image file for a system with a UC Booster Card. Both image files also include the software for the system telephones. In addition, there is also a separate image file for each type of system telephone type in case the system telephones need to be updated separately.

The following types of image files are available:

- **tgz**: for the software of the communication system. The tgz file contains a tar file. The tar file must be unpacked from the tgz file with a decompressor such as WinZip or 7-zip, for example. The tgz file is offered for download because a check can be performed to determine whether or not the file is corrupted when downloading the software from the server.
- **tar**: for the software of the communication system. It contains the packed files for each system component.
- **app**: for the software of the system telephone.

## Local Web Server

When performing a software update via a web server, the software server (Internet web server) is accessed by default.

However, it is also possible to use a local web server for updates. To do this, the image file must be stored on the local web server, and the path to the local web server must be configured in the WBM.

## Speed Upgrade

A speed upgrade as with the HiPath 3000 is not possible.

---

**IMPORTANT:** Pulling out the SDHC card during operation will result in the loss of data!

---

## 24.3.1 Using a Local Web Server

The software can be updated via a local web server.

The current image files must be stored on the local web server. In addition, the access data for the local web server must be entered in the WBM. This change can only be performed by an administrator with the **Expert** profile. After the access data of the local web server has been entered, this will be set as the default for all future updates of the communication system. In other words, the local web server will now be used instead of the Internet web server.

### 24.3.1.1 How to Configure Access to the Local Web Server

#### Prerequisites

- You are logged into the WBM with the **Expert** profile.
- A connection to the local web server is available.
- You will need the web address (URL) and the account information to access the local web server as well as the name of the image file.
- The image file is stored on the local web server as a tar file, and the storage location is known. The tar file may possibly need to be unpacked from the stored tgz file.
- If you use a proxy server for the update, you will also need its data (as well as the user name and password, where applicable).

#### Step by Step

- 1) In the navigation bar, click on **Expert Mode**.
- 2) Click **Maintenance > Software Image** in the navigation tree.
- 3) Click **System Software** in the menu tree.
- 4) Click on **Update via Internet**.

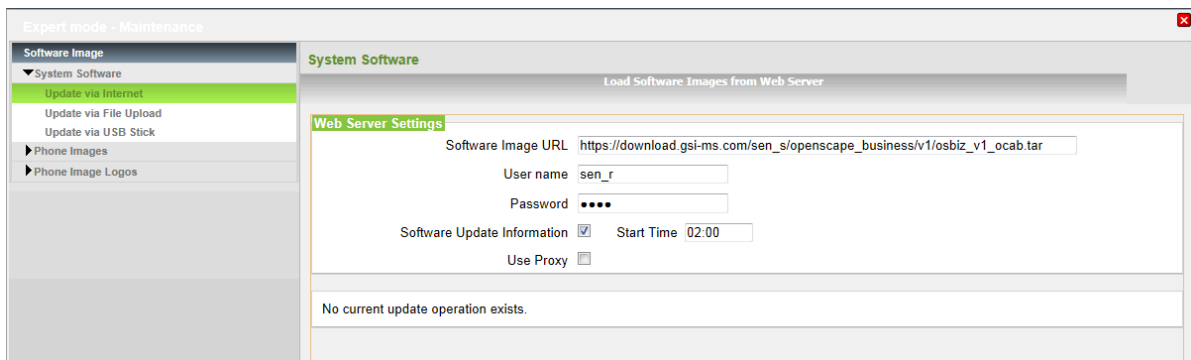

- 5) Set up access to the local web server:
  - a) Enter the address of the local web server, including the path and name of the image file, under **Software Image URL**.

---

**INFO:** The **Default** button can be used to reset the entered values back to their defaults.

---

- b) Enter the user name and password required to access the local web server in the **User Name** and **Password** fields.
- c) Select the **Software Update Information** check box and enter the time at which the server specified above should be searched for newer software under **Start Time**.
- d) If you are using a proxy server for the transfer, enable the **Use Proxy** check box and enter the data for the proxy server.

- 6) Click on **Apply**. The entered access data of the local web server is set as the default.

If a new image file is already available on the local web server, the software update is initiated, and the license agreement appears (see [How to Update the System via a Web Server](#)). The launch of the software update can, however, also be prevented if required.

## 24.3.2 Updating the Communication System

Updating the communication system includes updates to not only the software of the communication system itself, but also the software images of the system phones, which are stored on the communication system. A full update of all system components can thus be quickly and easily performed.

Before each software update, the configuration data of the communication system must be backed up ([Backup and Restore](#)).

### Updating via a Web Server

When performing a software update via a web server, the software server (Internet web server) is accessed by default.

If a local web server is being used, the image file must be stored on the local web server.

For a communication system without a UC Booster Card, it does not matter if an image file for a system with or without a UC Booster Card is used. Only the necessary components are installed.

The system checks for the presence of new software updates after automatically setting up a connection to the web server. For systems without UC Booster, individual software update packages can be unselected to reduce the download time. Only those packages that have changed with respect to the installed software version are transferred. The starting time for the software transfer and for the software activation can be selected. If the time of the software activation is reached before the software update has been completely transferred to the system, the activation is not executed automatically. A new time of activation must then be defined manually.

### Updating via USB Storage Device

The image file is stored on a USB device. The USB storage device must be inserted in the USB server port of the communication system. This type of update can only be performed by an administrator with the **Expert** profile and is not possible for OpenScape Business S and OpenScape Business UC Booster Server.

### Updating via a File Upload

The image file is in a directory in the internal network or on the admin PC.

### Update via a USB Device without WBM Access

The communication system can be updated directly without WBM access via a USB device. This requires the USB device to be plugged into the USB server port of the system and the image file to be located at the top level of the USB device. If a reset of the communication system is performed with the USB device inserted, the software update is started automatically. This type of update is not possible with OpenScape Business S. In a system with the OpenScape Business UC Booster Server, the server must be updated additionally.

### Updating the UC Booster Server

If a UC Booster Server is being operated in addition to the communication system, then the communication software of the UC Booster Server must also be updated when updating the system software. In other words, the software of the communication system and the UC Booster Server should always be at the same level. The software update of the UC Booster Server is basically identical to the software update for the communication system; the only difference is that the administrator does not specify the IP address of the communication system when calling the WBM, but the IP address of the Linux server.

## 24.3.2.1 How to Update the System via a Web Server

### Prerequisites

- You are logged on to the WBM with the **Advanced** profile.
- The availability of a new software version is indicated on the home page of WBM.
- Access to the web server is available. By default, the connection to the Internet web server is set up. Instead, a local web server can also be configured. (see [Using a Local Web Server](#)).
- If the update is to be performed via a local web server, the latest image file must be stored on the local web server.

### Step by Step

- 1) Click in the navigation bar on **Home** and then on **Details on the contents can be obtained from here: Link**. This will open a PDF file containing important information about the new software version. Read through the information and pay attention to the information about upgrading the system. Then close the window.
- 2) Click on **Service Center** in the navigation bar.
- 3) In the navigation tree, click on **Software Update > Update via Internet**. The currently installed software version is displayed to you.
- 4) Click on **OK & Next**.
- 5) Read the license agreement (EULA) fully and then enable the radio button **I accept the license agreement**.
- 6) Click on **OK & Next**.

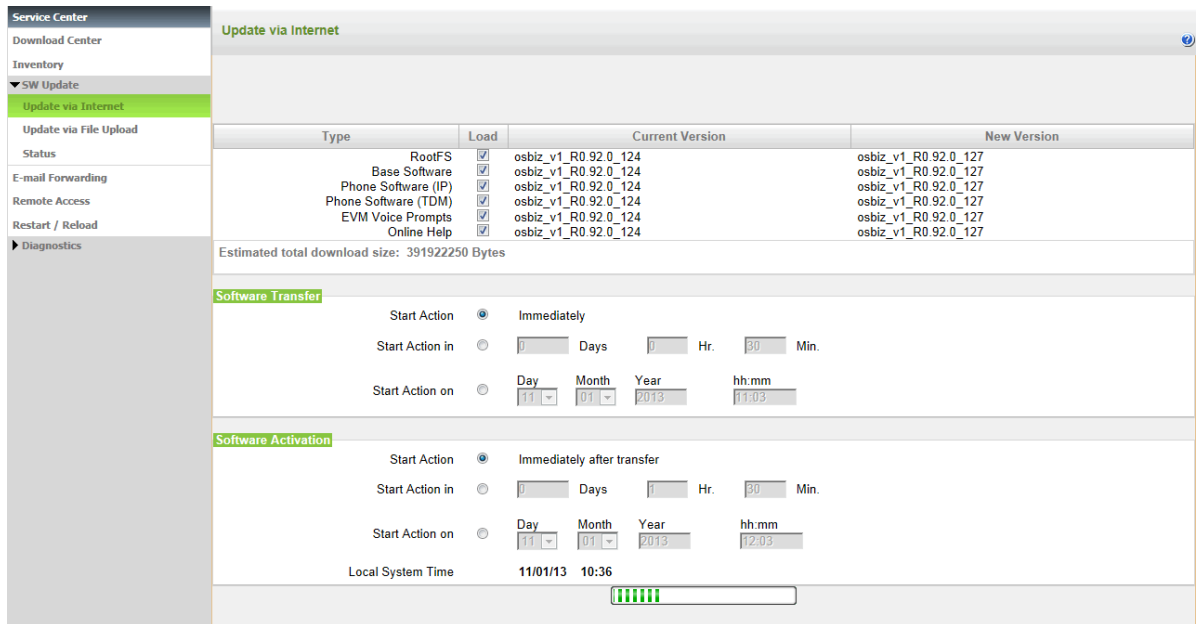

- 7) Disable the packages that should not be updated in the **Load** column if required. This is useful with slow Internet connections, for example, or software upgrades via ISDN.
  - 8) Select the times for the software transfer and software activation:
    - **Start Action - Immediate/Immediately after transfer:** The software will be transferred immediately and activated immediately after the transfer. The software update will be loaded into the communication system in the background. After two restarts, the software is up-to-date.
    - **Start Action in:** The software will be transferred and activated after a certain time period. Enter the time period for this in days, hours and minutes.
    - **Start Action on:** The software will be transferred and activated at a specific point in time. Enter the date and time for this point in time.
- 
- INFO:** If the time of the software activation is reached before the software update has been completely transferred to the system, the activation is not executed automatically. A new time of activation must then be defined manually.
- 
- 9) Click on **OK & Next**. The software update will be loaded into the system in the background and activated at the respective times you have configured. Two restarts are automatically performed one after the other for software activation.

---

**INFO:** You can close the browser window at any time.

---

- 10) You can check the current status of the update with the WBM under **Service Center > Software Update > Status**.

### 24.3.2.2 How to Update the System using a USB Storage Device

#### Prerequisites

- You are logged into the WBM with the **Expert** profile.
- The USB storage device must be formatted with FAT32.
- A current image file is stored as a tar file on the USB storage device. It is also possible to have multiple image files stored in different directories.
- If the USB storage device has multiple partitions, the image file must be stored in the first partition.

#### Step by Step

- 1) Insert the USB storage device into the USB server port on the motherboard.
- 2) In the navigation bar, click on **Expert Mode**.
- 3) Click **Maintenance > Software Image** in the navigation tree.
- 4) Click **System Software** in the menu tree.
- 5) Click on **Update via USB Stick**. All valid image files stored on the USB device are displayed with their respective version number and file name.

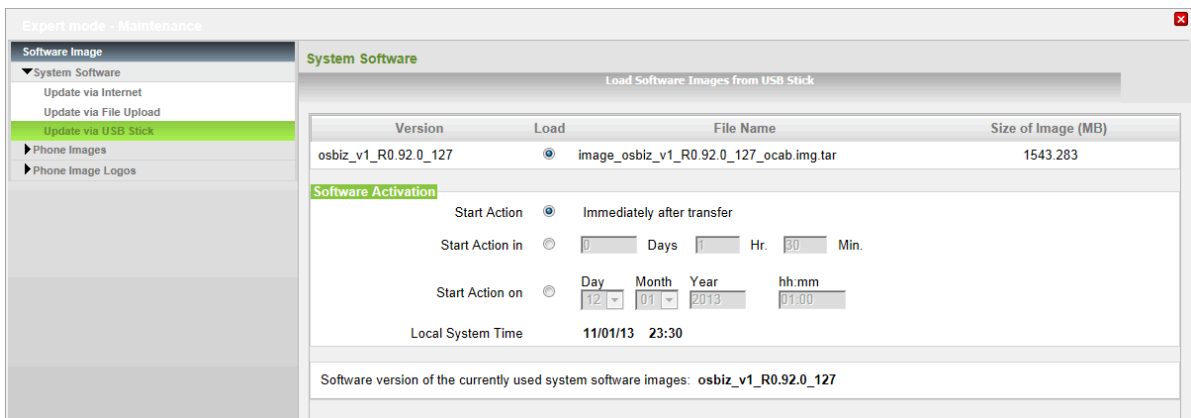

- 6) If multiple image files are stored, select the desired image file; otherwise, the image file is automatically selected.
- 7) Select the software activation time.
  - **Start Action - Immediately after transfer:** The software is activated immediately after it has been transferred to the communication system.
  - **Start Action in:** The software is immediately transferred to the communication system. After a specified time, the software is activated. Enter the time period for this in days, hours and minutes.
  - **Start Action on:** The software is immediately transferred to the communication system. The software is activated at a specified time. Enter the date and time for this point in time.

- 8) Click on **Load**. The image file is transferred to the communication system and checked for consistency. Several minutes are required for both processes. During this time, the USB device remain plugged in.
- 9) Unplug the USB device when instructed by the WBM and then click **Finish**. Two restarts are automatically performed one after the other at the time specified for the software activation.
- 10) You can check the current status of the update with the WBM under **Service Center > Software Update > Status**.

### 24.3.2.3 How to Update the System via File Upload

#### Prerequisites

- You are logged on to the WBM with the **Advanced** profile.
- The image file is stored on the internal network or directly on the Admin PC as a tar file, and the storage location is known. If a tgz file is stored, the tar file must be extracted from the tgz file.

#### Step by Step

- 1) Click on **Service Center** in the navigation bar.
- 2) In the navigation tree, click on **Software Update > Update via File Upload**. The currently installed software version is displayed to you.
- 3) Click on **OK & Next**.

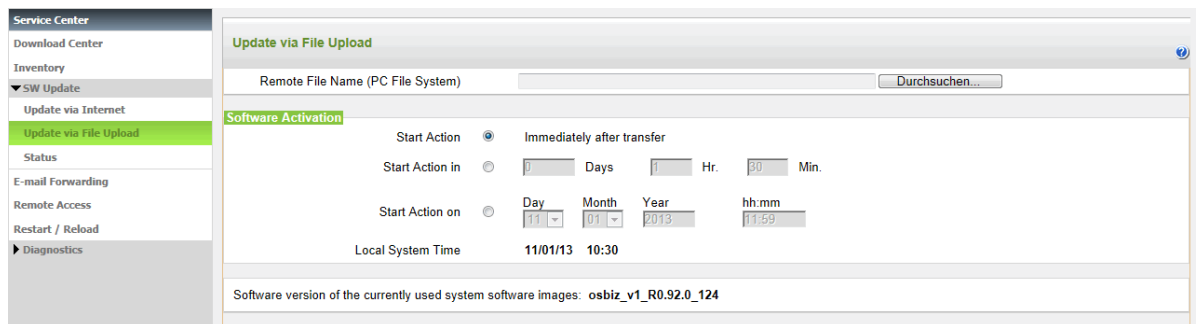

- 4) Click the **Browse** button to navigate to the storage location of the image file (\*.tar).
- 5) Select the software activation time.
  - **Start Action - Immediately after transfer:** The software is immediately transferred to the communications system in the background. After two restarts, the software is up-to-date.
  - **Start Action in:** The software is immediately transferred to the communications system in the background. After a specified time, the software is activated. Enter the time period for this in days, hours and minutes.

- **Start Action on:** The software is immediately transferred to the communications system in the background. The software is activated at a specified time. Enter the date and time for this point in time.
- 6) Click on **OK & Next**.
  - 7) The image file is transferred to the communication system and checked for consistency. Several minutes are required for both processes.

---

**INFO:** If you close the browser window during the software transfer, the operation is canceled. During the consistency checks, you can continue working with the WBM or close it.

---

- 8) If the software is to be activated immediately, two consecutive restarts automatically occur after the consistency check has been completed successfully.
- 9) If the software is not to be activated immediately, click **Stop** after the successful transfer. Two restarts are automatically performed one after the other for software activation.
- 10) You can check the current status of the update with the WBM under **Service Center > Software Update > Status**.

#### 24.3.2.4 How to Update the System via a USB Device without WBM Access

##### *Prerequisites*

- The USB storage device must be formatted with FAT32.
- A current image file is stored as a tar file at the topmost directory level of the USB storage device. Only one image file may be stored there.
- If the USB storage device has multiple partitions, the image file must be stored in the first partition.
- The software version of the image file must be newer than the software version of the system. Caution: It is also possible to "update" to older versions of the software.
- The communication system has been started.

##### *Step by Step*

- 1) Insert the USB storage device into the USB server port on the motherboard.
- 2) Press the reset button for 1 to 4 seconds. The system shuts down and initiates a restart.

During startup, the software is checked. If the USB device contains a suitable image file, the file is uploaded to the communication system. The red LED will flash at 1Hz (0.5 sec on / 0.5 sec off). Upon completion of the copy operation, the software is unpacked, and the customer data is automatically transferred. During this process, the red LED flashes in at 5Hz (100ms on / 100ms off).



- 3) Remove the USB device when the red LED flashes at 5Hz.
- 4) Finally, the system automatically performs two restarts in succession. When the green LED flashes at 1-Hz intervals (0.5 s on / 0.5 s off), the system is back in operation.

### 24.3.3 Updating System Telephones

The software of the system telephones is updated via an image file. For each type of system telephone, there is a separate image file that contains the phone software of this type. These image files are included in the software of the communication system and are automatically loaded into the communication system during updates.

The IP system telephones are thus automatically supplied with the current software. Whenever an IP system telephone is reconfigured in the WBM (from a **System Client** to a **SIP Client**, or vice versa), the appropriate software stored in the communication system is automatically loaded via the DLI into the IP system telephone. For IP system telephones that were already in operation at the system or at some other system, the factory settings must be first restored (factory reset) before the automatic software update can be performed.

Non-standard phone software can be transferred manually by the administrator to all IP system telephones of a specific type by using the WBM. The update of the software for UP0 system telephones is performed with Manager E.

If some specific phone software (image file) is flagged as the default in the WBM, the corresponding image will be automatically transferred to every IP system telephone associated with this type whenever that phone logs into the system for the first time.

When updating the software manually, it is important to ensure that the software of the system telephones is compatible with the software version of the communication system (see the Release Notes).

#### 24.3.3.1 How to Load the Phone Software into the System

##### *Prerequisites*

- You are logged into the WBM with the **Expert** profile.
- The image files are stored on the local network, and the storage location is known. A separate image file is required for each system telephone type.

##### *Step by Step*

- 1) In the navigation bar, click on **Expert Mode**.
- 2) Click **Maintenance > Software Image** in the navigation tree.
- 3) Click **Phone Images** in the menu tree.

- 4) Click **Load**. A list of all currently existing image files in the communication system is displayed.
- 5) Click the **Browse** button under **Remote File Name (PC File System)** to navigate to the storage location of the image file (\*.app).
- 6) Click on **Load**. The image file is loaded and checked for errors.

---

**INFO:** If an error occurs, you will receive an error message. Verify your entries and repeat steps 5 through 6.

---

- 7) If the check succeeds, confirm this with **OK**. The image file is added to the list of currently existing update files in the communication system.
- 8) To load additional image files for other system telephone types, repeat steps 5 through 7.

### 24.3.3.2 How to Deploy the Phone Software to System Telephones

#### *Prerequisites*

- You are logged into the WBM with the **Expert** profile.

#### *Step by Step*

- 1) In the navigation bar, click on **Expert Mode**.
- 2) Click **Maintenance > Software Image** in the navigation tree.
- 3) Click **Phone Images** in the menu tree.
- 4) If you want to deploy a phone image to all system telephones of a specific type:
  - a) Click **Deploy**. A list of all currently existing image files in the communication system is displayed.
  - b) Select the check box **Deploy** for the desired phone image or images.
- 5) If you want to deploy a phone image to a particular system telephone:
  - a) Click on **Deploy to device**. A list of the system telephones is displayed.
  - b) Select the phone image for the desired system telephone or telephones from the **Deployable software** drop-down list.
- 6) Click on **Apply**.

### 24.3.3.3 How to Delete the Phone Software

#### *Prerequisites*

- You are logged into the WBM with the **Expert** profile.

### **Step by Step**

- 1) In the navigation bar, click on **Expert Mode**.
- 2) Click **Maintenance > Software Image** in the navigation tree.
- 3) Click **Phone Images** in the menu tree.
- 4) Click **Load**. A list of all currently existing image files in the communication system is displayed.
- 5) Select the check box **Delete** in the row of the phone image to be deleted.
- 6) If you want to delete more phone images, repeat the previous step.
- 7) Click on **Delete**. All marked phone images will be deleted from the communication system.

## **24.3.3.4 How to Enable or Disable the Automatic Distribution of the Phone Software**

### **Prerequisites**

- You are logged into the WBM with the **Expert** profile.

### **Step by Step**

- 1) In the navigation bar, click on **Expert Mode**.
- 2) Click **Maintenance > Software Image** in the navigation tree.
- 3) Click **Phone Images** in the menu tree.
- 4) Click **Deploy**. A list of all currently existing image files in the communication system is displayed.
- 5) If the phone software should be automatically transferred to the system phones, select the **Standard** checkbox in the row of the desired image file (default setting).
- 6) If the phone software should not be automatically transferred to the system phones, clear the **Standard** checkbox in the row of the desired image file.
- 7) Click on **Apply**.

### 24.3.3.5 How to Convert an optiPoint WL2 professional from HFA to SIP

#### Prerequisites

- The intermediate version of the phone software is available as an image file (`prep70_39.img`).
- The final version of the phone software is also available as an image file, (e.g., the standard image file `swup_70-000-52.img`).
- The user data of the WL2 and the WLAN access data are known to you.
- A new SIP subscriber, including the SIP credentials, has been set up in the WBM of the system and licensed. The SIP credentials assigned in the system are known to you.

#### Step by Step

- 1) Upgrade to the intermediate version:
  - a) First install the intermediate version `prep70_39.img` via the WBM of the WL2 or the DLS. You can see the progress of this upgrade in the phone display.
  - b) Follow the instructions on the screen and wait until the WL2 is restarted.
  - c) After a successful start, confirm the message **Temp SW only - Please Update!** with **OK**.
- 2) Upgrade to the final version:
  - a) Now install a standard image file such as `swup_70-000-052.img`. For security reasons, no settings and user data are changed during the upgrade. You can see the progress of this upgrade in the phone display.
  - b) Follow the instructions on the screen and wait until the WL2 is restarted.
- 3) After a successful start, enable the default phone settings manually via the WBM of the WL2:
  - Option 1: In the WBM, navigate to **System Settings > Reset User Data > User Settings Clear**.
  - Option 2: In the WBM, navigate to **Factory Reset > Restore the factory defaults**.

---

**NOTICE:** Your user data and the Wi-Fi access data will be lost!

---

- 4) Enter the Wi-Fi access data at the phone to integrate the phone into the customer LAN.
- 5) Enter the SIP credentials at the phone so that the phone can log into the system as a SIP station.
- 6) In the WBM of the WL2, set the radio button **Network > SIP advanced > Auto Answer to On** to ensure the functionality of the phone in conjunction with the UC Suite clients.

### 24.3.3.6 How to Configure Automatic Re-flashing

Automatic re-flashing is an easy way to flash HFA software only for out of the box or factory reset OpenScape Desk Phone IP 35G Eco, using the system's DLI server.

#### Prerequisites

- You are logged into the WBM with the **Expert** profile.

---

**INFO:** Automatic re-flashing is valid only for out of the box devices (from the factory). Else, the factory settings must be restored on the device ("factory reset") before proceeding to automatic re-flashing.

---

#### Step by Step

- Configure the device with a number and as system client:
  - In the navigation bar, click on **Expert Mode**.
  - In the navigation tree, click **Telephony Server> Station> IP Clients**.
  - Enter the internal number in the **Callno** field.
  - Enter the public number in the **DID** field.
  - Enter a name for the device.
  - Select **System Client** from the **Type** drop down menu.
  - Click **Apply**.
- Set up the DHCP server to send the IP address of the DLI via the DHCP option:
  - In the navigation bar, click on **Expert Mode**.
  - In the navigation tree, click **Telephony Server> Network Interfaces> DHCP> DHCP-Server> Edit Global Parameters**.
  - Check the **Use Internal DLI** option at the **DNS Server** section.
- Plug in the device and specify the terminal number once the phone is started.
- The phone is also registered to the DLI database. To verify the device registration:
  - Click on **Expert Mode** in the navigation bar.
  - Click **Maintenance> Software Image** in the navigation tree.
  - Click **Phone Images** in the menu tree.
  - Click on **Deploy to Device**.
- Automatic re-flashing starts and loads the HFA software stored in the communication system to the device.

---

**INFO:** Do not unplug the device during this process.

---

The device is now configured.

---

**INFO:** If the device is set to SIP (under **Telephony Server > Station > IP Clients**), it will update to the latest SIP software, only if the update is available in the corresponding software release.

When a SIP Client is changed to System Client, a manual restart of the phone is needed in order to load the HFA software.

---

---

**INFO:** If the re-flashing process is unsuccessful, the factory settings must be restored ("factory reset") on the device.

---

## 24.3.4 Software Status

The software status provides information about the software version and the software update.

The following statuses can be displayed:

- Current version of the software
- Newer version available for an update
- Time at which the software update is to be performed
- New software being loaded into the system
- Successful or failure of the loading process

### 24.3.4.1 How to Check the Software Status

#### *Prerequisites*

- You are logged on to the WBM with the **Advanced** profile.

#### *Step by Step*

- 1) Click on **Service Center** in the navigation bar.
- 2) Click **Software Update > Status** in the navigation tree. You will be presented with the latest version of the software. This information is also displayed on the home page of WBM.

If a software update is running in the background, you will be notified about this here.

If a new software update is available on the web server, you will be likewise notified about this here. This information is also displayed on the home page of WBM.

## 24.4 Restart, Reload, Shutdown

You can use the associated features to initiate a restart or reload of the OpenScape Business communication systems or the UC Booster Card and for a controlled shutdown of OpenScape Business X. In addition, a restart (reboot) of the UC application (UC Smart or UC Suite) is triggered. To enable the controlled shutdown of OpenScape Business X via a system telephone, a PIN can be defined.

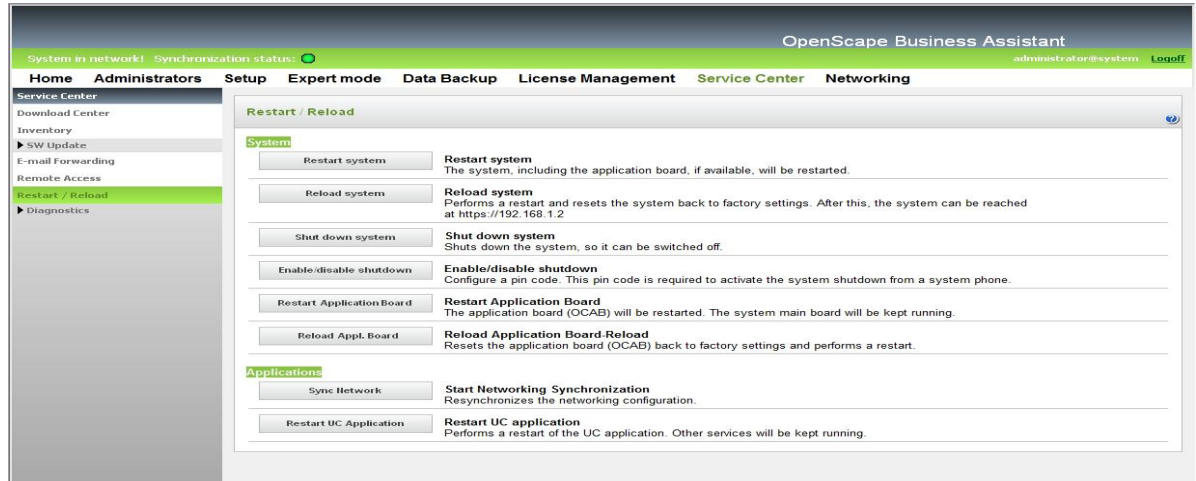

### Restarting and Reloading the UC Booster Server

If a UC Booster Server is being operated in addition to the communication system, the communication software of the UC Booster Server can also be restarted or reloaded. The restart/reload of the UC Booster Server is basically identical to the restart/reload of the communication system; the only difference is that the administrator does not specify the IP address of the communication system when calling the WBM, but the IP address of the Linux server.

### 24.4.1 Restarting OpenScape Business

The **Restart system** function can be used to initiate a controlled restart of OpenScape Business.

The following differences must be observed:

- OpenScape Business S and OpenScape Business X  
A controlled restart of the communication system occurs. The communication system will be operational again after the startup.  
The startup time depends on system configuration and the OpenScape Business networking scenario.  
If OpenScape Business X3/X5/X8 is equipped with a UC Booster Card (Application Board OCAB), a controlled restart (reboot) of the UC Application (UC Smart or UC Suite) also occurs.

## Maintenance

Restart, Reload, Shutdown

- OpenScape Business UC Booster Server (Application Server)  
A controlled restart of the OpenScape Business portion and the UC Application (UC Suite) occurs. The UC Application will be operational again after the startup.

During a restart, all active applications such as myPortal for Desktop and myPortal for Outlook, for example, are disconnected. After the startup, all connections are automatically set up again.

### 24.4.1.1 How to Initiate a Restart of OpenScape Business

The **Restart system** function can be used to initiate a restart of OpenScape Business.

#### Prerequisites

- You are logged on to the WBM with the **Advanced** profile.

---

**INFO:** During a restart, all active applications such as myPortal for Desktop and myPortal for Outlook, for example, are disconnected. After the startup, all connections are automatically set up again.

---

#### Step by Step

- 1) Click on **Service Center** in the navigation bar.
- 2) Click **Restart / Reload** in the navigation tree.
- 3) Click on **Restart system** followed by **OK**. OpenScape Business performs a restart (reboot).

OpenScape Business S and OpenScape Business X: The communication system will be operational again after the startup.

OpenScape Business UC Booster Server: After the startup, the UC Application (UC Suite) will be operational again.

### 24.4.2 Reloading OpenScape Business

The **Reload system** function can be used to initiate a reload of OpenScape Business.

The following differences must be observed:

- OpenScape Business S and OpenScape Business X  
The communication system is reloaded. After the subsequent startup, the communication system will be in its default state.
  - All country and customer-specific settings were deleted (system country code = Germany).



- The communication system has the default IP address 192.168.1.2 and the internal IP range 192.168.3.xxx.
- The licensing is retained.  
The startup time depends on system configuration.
- OpenScape Business UC Booster Server  
The OpenScape Business portion is reloaded. After the subsequent startup, the OpenScape Business portion will be in its default state.
  - All custom (i.e., customer-specific) settings of the OpenScape Business portion (e.g., the User Directory) were deleted.
  - The licensing is retained.  
The operating system will not be reset.

### 24.4.2.1 How to Initiate a Reload of OpenScape Business

The **Reload system** function can be used to initiate a reload of OpenScape Business.

#### **Prerequisites**

- You are logged on to the WBM with the **Advanced** profile.
- OpenScape Business S and OpenScape Business X: The configuration data of the communication system was saved in a backup set.

---

**NOTICE:** The reload reverts the communication system to its default state. All country and customer-specific settings are deleted (system country code = Germany). The default IP address (192.168.1.2) of the communication system is reset.

---

- OpenScape Business UC Booster Server: The configuration data of the OpenScape Business portion was saved in a backup set.

---

**NOTICE:** The reload reverts the OpenScape Business portion to its default state. All custom (i.e., customer-specific) settings of the OpenScape Business portion (e.g., the User Directory) are deleted.

---

#### **Step by Step**

- 1) Click on **Service Center** in the navigation bar.
- 2) Click **Restart / Reload** in the navigation tree.
- 3) Click on **Reload system**, followed by **OK**. OpenScape Business reloads.

---

**INFO:** OpenScape Business S and OpenScape Business X:  
After the subsequent startup, the communication system will be in its default state. After the basic settings have been configured

## Maintenance

Restart, Reload, Shutdown

using the Initial Installation wizard, country- and customer-specific data backups can be reloaded. For more detailed information on the procedure, see [Restore](#).

OpenScape Business UC Booster Server: After the subsequent startup, the OpenScape Business portion will be in its default state. The backed-up customer-specific data can be reloaded. For more detailed information on the procedure, see [Restore](#).

---

## 24.4.3 Shutting Down OpenScape Business X

The **Shut down system** function can be used to shut down the OpenScape Business X communication systems gracefully, i.e., to perform a controlled shutdown.

### 24.4.3.1 How to Shut Down OpenScape Business X

The **Shut down system** function can be used to shut down OpenScape Business X communication systems gracefully, i.e., to perform a controlled shutdown.

#### *Prerequisites*

- You are logged on to the WBM with the **Advanced** profile.

#### *Step by Step*

- 1) Click on **Service Center** in the navigation bar.
- 2) Click **Restart / Reload** in the navigation tree.
- 3) Click on **Shut down system** followed by **OK**. A controlled shutdown of the communication system is performed.

---

**INFO:** OpenScape Business X1/X3/X5: The subsequent startup of the communication system is only possible by unplugging and then reinserting the power plug.

OpenScape Business X8: the subsequent startup of the communication system is only possible by switching off all LUNA2 power supplies and then switching them back on again.

---

## 24.4.4 PIN for the controlled shutdown of OpenScape Business X

The activation of the shutdown via a system telephone is PIN-protected.

The PIN configured in the communication system must be entered for the activation via a system telephone. The configuration of this PIN is performed by an administrator with the **Advanced** profile.

#### 24.4.4.1 How to Configure a PIN for the Controlled Shutdown of OpenScape Business X

The PIN is for initiating a shutdown via a system telephone.

##### *Prerequisites*

- You are logged on to the WBM with the **Advanced** profile.

##### *Step by Step*

- 1) Click on **Service Center** in the navigation bar.
- 2) Click **Restart / Reload** in the navigation tree.
- 3) Click on **Enable/disable shutdown**.
- 4) Enter the desired six-digit PIN in the **PIN** field.
- 5) Click on **Save** followed by **OK**.

##### *Next steps*

The activation of a shutdown via a system telephone occurs by entering the corresponding code (default code = \*997), followed by the six-digit PIN.

#### 24.4.5 Restarting (Rebooting) the UC Booster Card (Application Board OCAB)

As an administrator, you can use the **Restart Application Board** function to initiate a controlled restart of the Application Board OCAB, including the UC application (UC Smart or UC Suite).

During a restart, all active applications such as myPortal for Desktop and myPortal for Outlook, for example, are disconnected. After the startup, all connections are automatically set up again.

In addition, the integrated XMPP server, the CSTA interface, the Presence Manager, Announcement Player, Media Extension Bridge, Open Directory Service and the Gate View server are likewise restarted.

##### 24.4.5.1 How to Initiate a Restart of the UC Booster Card (OCAB Application Board)

The **Restart Application Board** function can be used to initiate a controlled restart of the Application Board OCAB, including the UC application (UC Smart or UC Suite).

## Maintenance

Restart, Reload, Shutdown

### Prerequisites

- You are logged on to the WBM with the **Advanced** profile.

---

**INFO:** During a restart, all active applications such as myPortal for Desktop and myPortal for Outlook, for example, are disconnected. After the startup, all connections are automatically set up again.

---

### Step by Step

- 1) Click on **Service Center** in the navigation bar.
- 2) Click **Restart / Reload** in the navigation tree.
- 3) Click on **Restart Application Board** followed by **OK**. The UC Booster Card (Application Board OCAB) performs a restart.

## 24.4.6 Reloading the UC Booster Card (Application Board OCAB)

The **Reload UC Booster Card** function can be used to initiate a reload of the Application Board OCAB, including the UC application (UC Smart or UC Suite).

The Reload UC Booster Card function is used to reset the card to the factory settings and then remove it from the system. This may be necessary if the card is no longer to be used in this system due to a switch to the UC Booster Server or if it is to be installed in another OpenScape Business system.

All customer-specific data and all diagnostic data are deleted from the UC Booster Card, and the system shuts down. Then, the system must be unplugged from the power supply, and the UC Booster Card must be removed.

After the UC Booster Card has been removed and the system is rebooted, a new backup set must be created, since the configuration data has changed and the old backup set is no longer compatible. If the hard disk of the UC Booster Card was previously used as a backup medium, then another backup medium such as a network drive, a USB device or an FTP/FTPS server must be now selected (see also the [Backup and Restore](#)).

### 24.4.6.1 How to Initiate a Reload of the UC Booster Card (OCAB Application Board)

The **UC Booster Card Reload** function can be used to initiate a reload of the Application Board OCAB, including the UC application (UC Smart or UC Suite).

### Prerequisites

- You are logged on to the WBM with the **Advanced** profile.

### **Step by Step**

- 1) Click on **Service Center** in the navigation bar.
- 2) Click **Restart / Reload** in the navigation tree.
- 3) Click on **UC Booster Card Reload**, followed by **OK**. You are logged out of the WBM. The card is reset to the factory settings, and the system then shuts down.
- 4) Once the Green RUN LED of the mainboard and the controller LEDs of the UC Booster Card are completely turned off, unplug the system from the power supply and remove the UC Booster Card (see the *Service Documentation, Hardware Installation* for details).
- 5) Create a new backup set after the system has rebooted, since the configuration data has changed, and the old backup set is no longer compatible (see also the section on [Backup and Restore](#)).

## **24.4.7 Restarting the UC Application**

The **Restart UC Application** function can be used by an administrator to initiate a controlled restart of the UC Application (UC Smart or UC Suite).

During a restart of the UC Application, all active applications such as myPortal for Desktop, myPortal Smart and myAttendant, for example, are disconnected. After the startup, all connections are automatically set up again.

### **24.4.7.1 How to Initiate a Restart of the UC Application**

The **Restart UC Application** function can be used to initiate a restart of the UC Application (UC Smart or UC Suite).

#### **Prerequisites**

- You are logged on to the WBM with the **Advanced** profile.

---

**INFO:** During a restart, all active applications such as myPortal for Desktop, myPortal Smart and myAttendant, for example, are disconnected. After the startup, all connections are automatically set up again.

---

### **Step by Step**

- 1) Click on **Service Center** in the navigation bar.
- 2) Click **Restart / Reload** in the navigation tree.
- 3) Click on **Restart UC Application** followed by **OK**. The UC Application performs a restart.

## 24.5 Inventory Management

The term Inventory Management refers to the process for determining the current status of the OpenScape Business X and OpenScape Business S communication systems and the hardware configuration of the OpenScape Business X communication system.

### 24.5.1 System Status

The current status of the OpenScape Business X and OpenScape Business S communication systems can be determined by an administrator via the WBM. The following information can be retrieved: status of the stations, connection setup, ITSPs, VPNs and the list of configured IP addresses.

#### **Station status**

The station status enables the following information on the configured stations to be retrieved:

- Station number
- Name
- Device type
- IP address (for system telephones, an additional link through which the WBM of the phone can be opened is displayed.)
- MAC Address
- Current SW version
- HW version
- Status (On/Off)

#### **Dial-up Network Status**

The dial-up network status enables information on existing connections to PSTN partners (i.e., Public Switched Telephone Network partners such as public or home telecommunications networks, for example) of the OpenScape Business X communication system to be retrieved.

#### **ITSP Status**

The ITSP status enables information on the current status of preconfigured and any possibly added Internet Telephony Service Providers (ITSPs) to be retrieved. In addition, it shows which stations were set up for which ITSP.

The status of each active ITSP is indicated by the color of the associated rectangle (green = OK, orange = at least one of the stations was not properly configured).

### VPN Status

The VPN status enables information on the configured VPN tunnels of the OpenScape Business X communication system to be retrieved:

### Overview of IP Addresses

The IP addresses configured in the OpenScape Business X communication system are displayed.

In addition, the overview also shows with which wizards and with which menus in Expert mode the IP addresses can be configured.

Also, a status overview of the Booster Card and the Mainboard Ethernet Interfaces is displayed.

## 24.5.1.1 How to Check the Station Status

The **Status** wizard can be used to determine the current status of all configured stations.

### *Prerequisites*

- You are logged on to the WBM with the **Advanced** profile.

### *Step by Step*

- 1) Click on **Service Center** in the navigation bar.
- 2) Click **Diagnostics > Status** in the navigation tree.
- 3) Click on the **Station Status** tab. The status of all configured stations is displayed.

Service Center - Diagnostics - Status							
Station Status		Dialup Network Status	ITSP Status	VPN Status	Overview of IP Addresses		
Callno	Name	Device Type	IP address	MAC Address	SW actual	HW version	Status
32xxx	Abc,XYZ	SIP Extension	-	-	-	-	Enabled
32xxx	Abc,XYZ	OpenStage 80	<a href="#">172.17.xxx.xxx</a>	00:01:e3:25:e7:20	V2R0.94.0 HFA C01	-	Enabled
32xxx	Abc,XYZ	SIP Extension	-	-	-	-	Disabled
32xxx	Abc,XYZ	OpenStage 60	<a href="#">172.17.xxx.xxx</a>	00:1a:e8:0c:0d:cf	V2R0.94.0 HFA C01	-	Enabled
32xxx	Abc,XYZ	optiset E comfort	-	-	V5.0R0.23	-	Disabled
32xxx	Abc,XYZ	optiPoint 410 Standard	<a href="#">172.17.xxx.xxx</a>	00:01:e3:21:d6:3c	V5R6.7.0 HFA C01	-	Enabled
32xxx	Abc,XYZ	optiPoint 420 Standard	<a href="#">172.17.xxx.xxx</a>	00:01:e3:23:eb:49	V5R6.7.0 HFA C01	-	Enabled
32xxx	Abc,XYZ	OpenStage 40	<a href="#">172.17.xxx.xxx</a>	00:01:e3:2f:c5:66	V2R0.94.0 HFA C01	-	Enabled
32xxx	Abc,XYZ	OpenStage 40	<a href="#">172.17.xxx.xxx</a>	00:01:e3:2f:b3:c9	V2R0.94.0 HFA C01	-	Enabled
32xxx	Abc,XYZ	OpenStage 40	<a href="#">172.17.xxx.xxx</a>	00:01:e3:2f:c5:40	V2R0.94.0 HFA C01	-	Enabled
32xxx	Abc,XYZ	OpenStage 60	<a href="#">172.17.xxx.xxx</a>	00:01:e3:25:e7:8b	V2R0.94.0 HFA C01	-	Enabled
32xxx	Abc,XYZ	OpenStage 40	<a href="#">172.17.xxx.xxx</a>	00:01:e3:2f:c6:7e	V2R0.94.0 HFA C01	-	Enabled
32xxx	Abc,XYZ	OpenStage 60	<a href="#">172.17.xxx.xxx</a>	00:01:e3:25:f0:c5	V2R0.94.0 HFA C01	-	Enabled
32xxx	Abc,XYZ	OpenStage 40	<a href="#">172.17.xxx.xxx</a>	00:01:e3:2f:c1:3b	V2R0.94.0 HFA C01	-	Enabled
32xxx	Abc,XYZ	OpenStage 60	<a href="#">172.17.xxx.xxx</a>	00:01:e3:25:e7:d6	V2R0.94.0 HFA C01	-	Enabled
32xxx	Abc,XYZ	OpenStage 60	<a href="#">172.17.xxx.xxx</a>	00:01:e3:25:ee:cc	V2R0.94.0 HFA C01	-	Enabled

Buttons: Help, Abort, Back, Finish

4) Click on **Finish**.

### 24.5.1.2 How to Check the Status of the Connection Setup

The **Status** wizard can be used to determine the current status of the PSTN peers of an OpenScope Business X system.

#### Prerequisites

- You are logged on to the WBM with the **Advanced** profile.

#### Step by Step

- 1) Click on **Service Center** in the navigation bar.
- 2) Click **Diagnostics > Status** in the navigation tree.
- 3) Click on the **Dialup Network Status** tab. The list of PSTN peers is displayed.
- 4) Click in the row of the desired connection (PSTN peer) on **Display**. The current status of this connection (PSTN peers) is displayed.



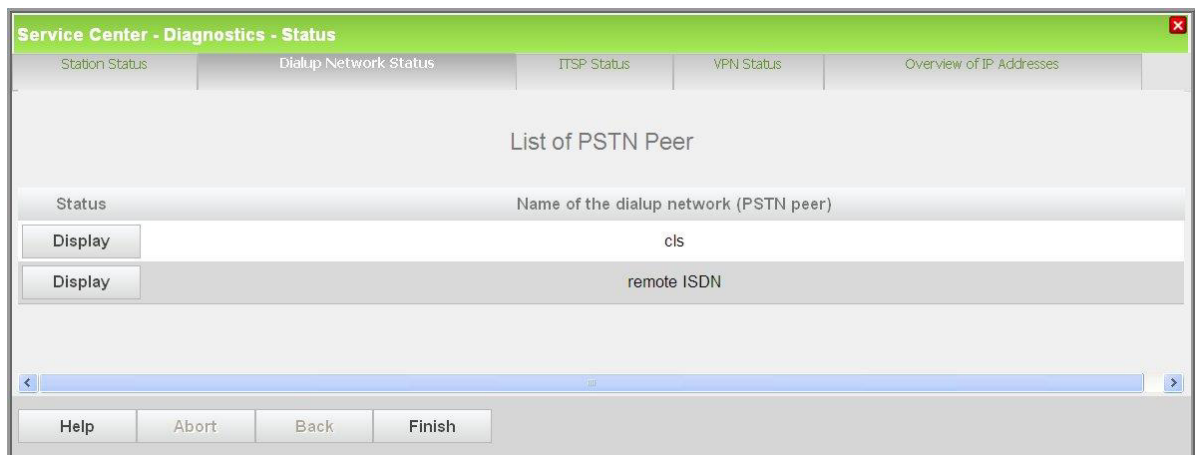

- 5) If you want to retrieve the status information of a further connection (PSTN peer), continue as described under Step 3.
- 6) Click on **OK** followed by **Finish**.

### 24.5.1.3 How to Check the ITSP Status

The **Status** wizard can be used to determine the current status of the Internet Telephony Service Provider (ITSP).

#### *Prerequisites*

- You are logged on to the WBM with the **Advanced** profile.

#### *Step by Step*

- 1) Click on **Service Center** in the navigation bar.
- 2) Click **Diagnostics > Status** in the navigation tree.
- 3) Click on the **ITSP Status** tab. The current status of the preconfigured and any possibly added Internet Telephony Service Providers (ITSPs) in active status is displayed.
- 4) Click on **Diagnose** to get additional information about the SIP connection.
- 5) Click on **Finish**.

### 24.5.1.4 How to Check the VPN Status

The **Status** wizard can be used to determine the current status of all configured VPN tunnels of an OpenScape Business X communication system.

#### *Prerequisites*

- You are logged on to the WBM with the **Advanced** profile.

### Step by Step

- 1) Click on **Service Center** in the navigation bar.
- 2) Click **Diagnostics > Status** in the navigation tree.
- 3) Click on the **VPN Status** tab. The status of all configured VPN tunnels is displayed.

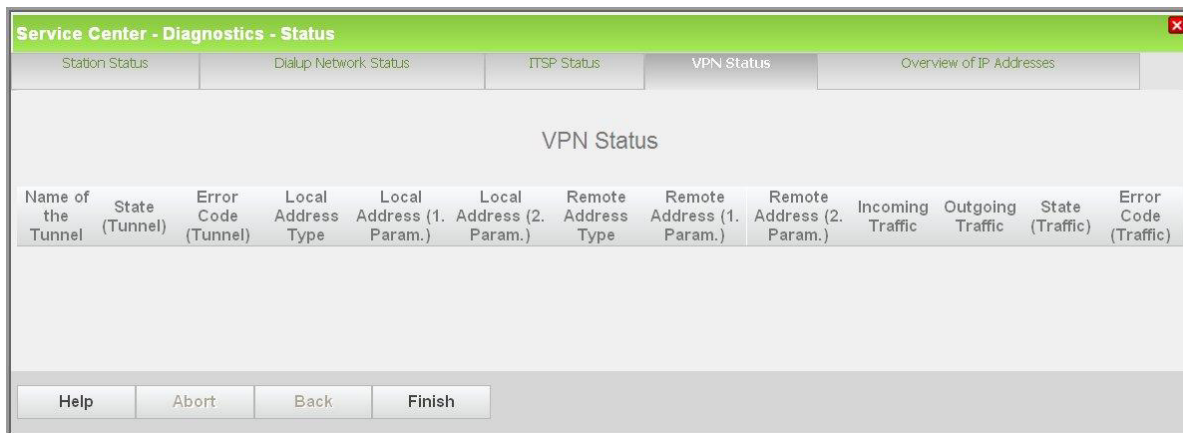

- 4) Click on **Finish**.

### 24.5.1.5 How to Display IP Addresses

The **Status** wizard can be used to obtain an overview of the IP addresses configured in an OpenScape Business X communication system. In addition, the overview also shows with which wizards and with which menus in Expert mode the IP addresses can be configured.

#### Prerequisites

- You are logged on to the WBM with the **Advanced** profile.

#### Step by Step

- 1) Click on **Service Center** in the navigation bar.
- 2) Click **Diagnostics > Status** in the navigation tree.
- 3) Click on the **Overview IP Addresses** tab. An overview of the IP addresses configured in the communication system is displayed.

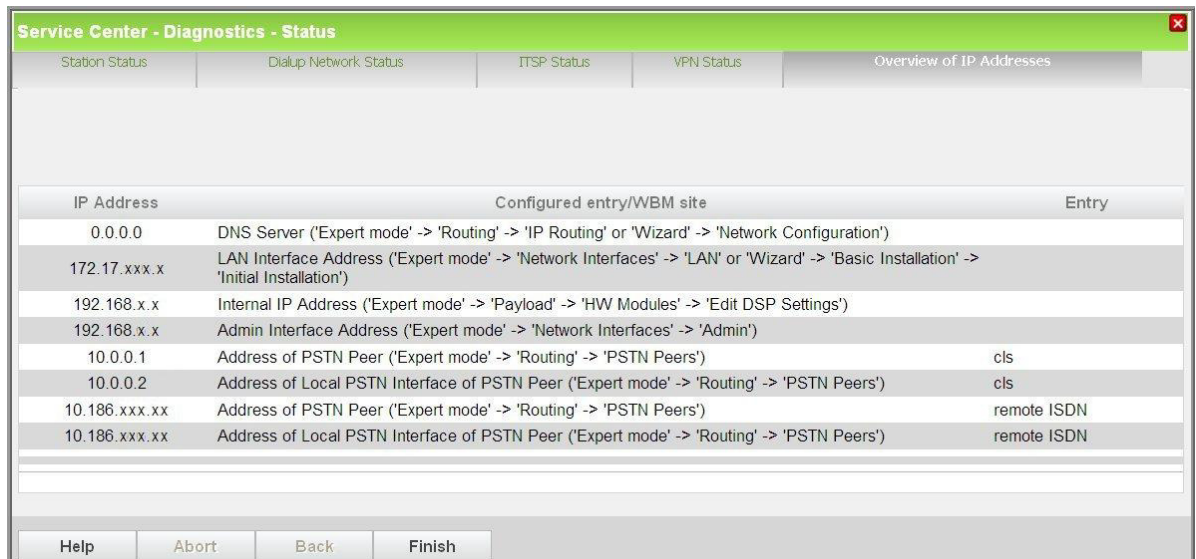

4) Click on **Finish**.

## 24.5.2 Inventory

The Inventory enables an administrator to retrieve information on the hardware and software of OpenScope Business X and the software of OpenScope Business S.

### OpenScope Business X

The following details can be retrieved:

- Communication system
  - Among other things, the following information is displayed:
    - Graphical representation of the communication system and the boards
    - Part number of the mainboard, MAC address, IP address, host name and software version
    - Details on memory amounts, including the available and used space on the SDHC card.
    - Status of all applications
- Boards
  - The displayed information includes the following: slot, type, part number and status of all installed boards.
- UC Booster Card (Application Board OCAB), if available
  - Among other things, the following information is displayed:
    - MAC address, IP address, host name and software version
    - Details on memory amounts, including the available and used hard disk space.
    - Status of all applications

- Overview of all Booster Card interfaces

The link **UC Booster Card accessible** in the home page of WBM directs the user to the **Service Center > Inventory > Booster Card** for a detailed view. The link will exist, even if there is a problem with the Booster Card and the text shows **UC Booster Card not accessible**.

The following error messages are displayed in the home page of WBM, depending on the error:

- Inter-Integrated Circuit link with Booster Card not possible
- Internet Protocol v6 connectivity to Booster Card not possible
- Internet Protocol v4 connectivity to Booster Card not possible
- Secure Socket Shell connectivity to Booster Card not possible
- Network File System connectivity to Booster Card not possible
- One or more Ethernet Interfaces are in Half Duplex mode, Full Duplex is highly recommended

### **OpenScape Business S**

The following details can be retrieved:

- Software  
Among other things, the following information is displayed: MAC address, IP address, host name and software version.
- Hard Disk Information  
Details on memory amounts, including the available and used memory.
- Applications  
All applications and their respective statuses are displayed.

## **24.5.2.1 How to Check the Inventory of OpenScape Business X**

The **Inventory** wizard can be used to determine the current status of the hardware and software of the OpenScape Business X communication systems.

### ***Prerequisites***

- You are logged on to the WBM with the **Advanced** profile.

### ***Step by Step***

- 1) Click on **Service Center** in the navigation bar.
- 2) In the navigation tree, click **Inventory**. You will be shown a graphical representation of the communication system and the boards.

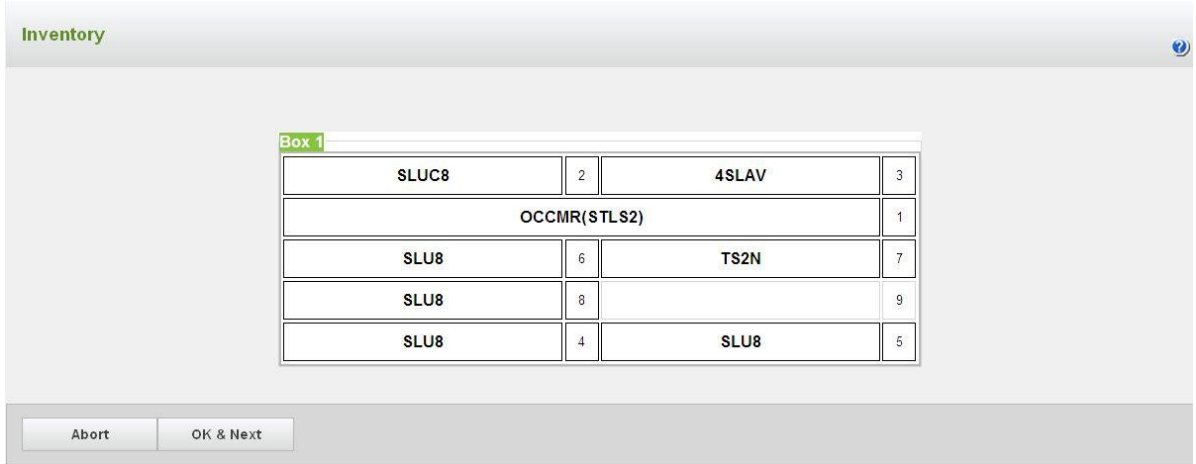

- 3) Click on **OK & Next**. Information on the communication system, the available and used space on the SDHC card, the boards and the application status will be displayed.

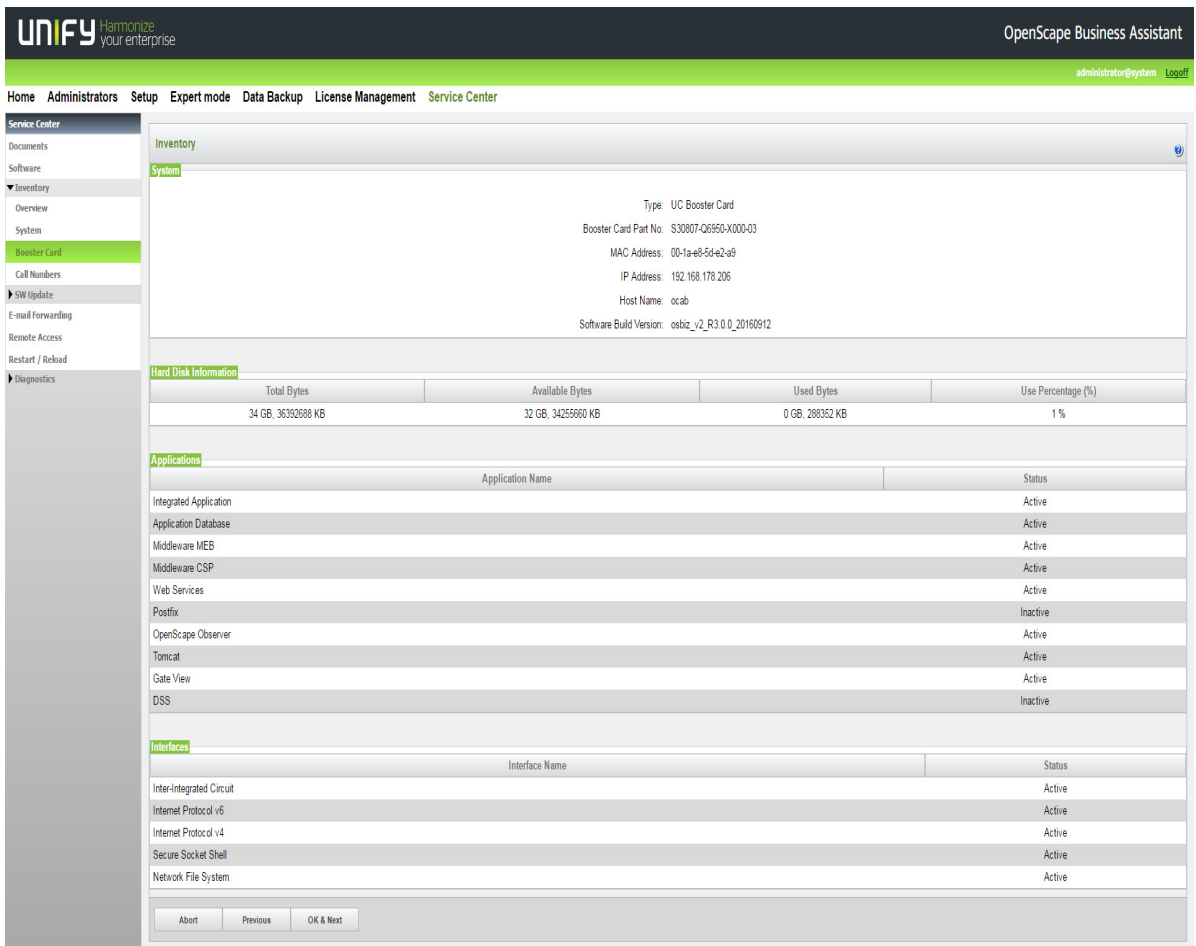

Slot Modules				
Slot No.	Card Type	Part No.	Interface - Ports	Status
1	OCCS(STLS2)	S30810-Q2958-X000-02	S0	Active
2	SLUC8	Slot is integrated in mainboard	UP0	Active
3	4SLAV	Slot is integrated in mainboard	a/b	Active
11	EVM	Slot is integrated in mainboard	EVM	Active

Sub Modules	
Module Type	Part No.
CMAe	S30807-Q6957-X

Applications	
Application Name	Status
Feature Process	Active
LDH	Active
Admin Framework	Active
Application Database	Active
License Agent	Active
Web Services	Active
Postfix	Inactive
Backup/Restore	Active
OpenScope Observer	Active
Announcement-Player	Active
RSPserviceLink	Inactive

Abort Previous OK & Next

- 4) Click on **OK & Next**. The subsequently displayed information depends on whether or not the communication system is equipped with a UC Booster Card (Application Board OCAB):
  - a) If your communication system is not equipped with a UC Booster Card: Information on the assignment of call numbers to the boards is displayed.
  - b) If your communication system is equipped with a UC Booster Card: Information on the OCAB Board, on the available and used storage space on the hard drive and on the application status and on the status of the Booster Card interfaces is displayed.

Click on **OK & Next**. Details on the allocation of call numbers to the boards will be displayed.
- 5) Click on **Finish**.

### 24.5.2.2 How to Check the Inventory of OpenScope Business S

You can check the current status of the OpenScope Business S software with the **Inventory** wizard.

#### *Prerequisites*

- You are logged on to the WBM with the **Advanced** profile.

#### *Step by Step*

- 1) Click on **Service Center** in the navigation bar.
- 2) In the navigation tree, click **Inventory**. Information on the software of the communication system, the available and used hard disk storage and on the application status will be displayed.

## 24.6 Automatic Actions

This function can be used to define actions to be executed once or at regular intervals. These actions are then executed automatically by the communication system at the set time.

### 24.6.1 Garbage Collection Automatic Action

The automatic action Garbage Collection enables an automatic garbage collection to be performed on the communication system. After each garbage collection has been completed, the communication system performs a restart (reboot).

The color of the list item displayed in the menu tree indicates the status of the action (green = action activated, red = action not activated).

**Start/Stop Action** can be used to enable or start an inactive action (red list item) and to disable or stop an active action (green bullet point).

The automatic action Garbage Collection is disabled by default.

#### 24.6.1.1 How to Edit the Garbage Collection Action

##### *Prerequisites*

- You are logged into the WBM with the **Expert** profile.

##### *Step by Step*

- 1) In the navigation bar, click on **Expert Mode**.
- 2) Click **Maintenance > Actions** in the navigation tree.
- 3) Click on **Actions > Automatic Actions > Garbage Collection** in the menu tree.
- 4) Click on the **Edit Action** tab.

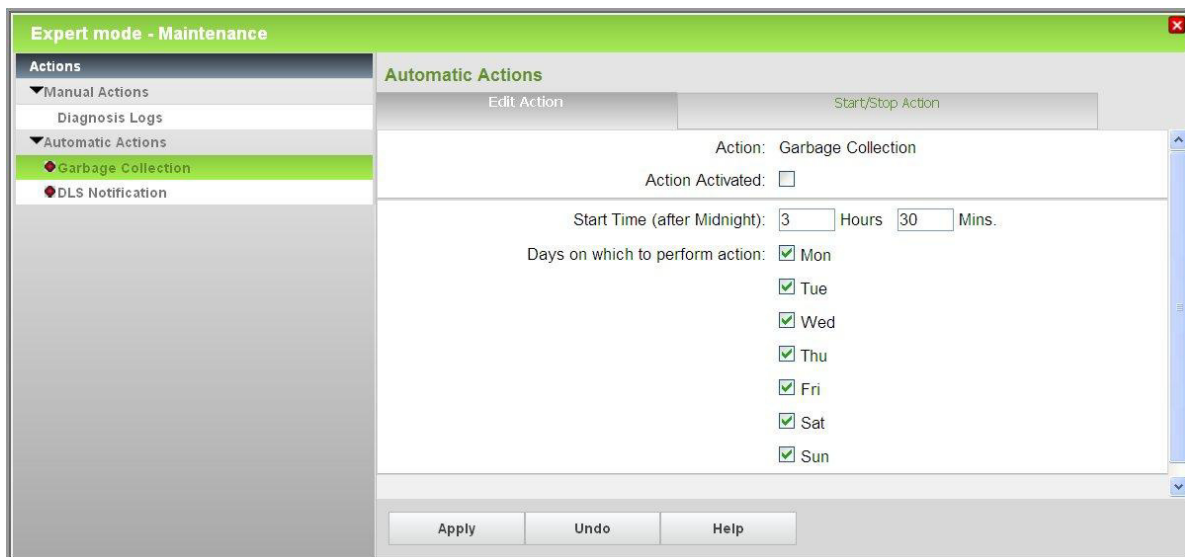

- 5) Select the desired setting.
  - If you want the Garbage Collection action to be performed, select the **Action Activated** check box.
  - If you do not want the Garbage Collection action to be performed, clear the **Action Activated** check box.
- 6) If appropriate, change the **Start Time (after Midnight)**.

Enter the number of hours in the **Hrs** field and the number of minutes in the **Mins** field to indicate the interval after which the action should be executed.

Example: Let us assume that the values entered in the **Hrs** field was 3 and in the **Mins** field was 30. This means the garbage collection action will be performed at 3:30 a.m. every morning.
- 7) If required, change the weekdays via **Days on which to Perform Action**.

Enable the check boxes of the weekdays on which the action is to be performed. Clear the check boxes of the weekdays on which the action is not to be performed.
- 8) Click on **Apply** followed by **OK**.

### 24.6.1.2 How to Start the Garbage Collection Automatic Action (Activate)

#### *Prerequisites*

- You are logged into the WBM with the **Expert** profile.

#### *Step by Step*

- 1) In the navigation bar, click on **Expert Mode**.
- 2) Click **Maintenance > Actions** in the navigation tree.



- 3) Click on **Actions > Automatic Actions** in the menu tree. The names of all automatic actions are displayed in the menu tree. Disabled actions are flagged with a red bullet point. Enabled actions are flagged with a green bullet point.
- 4) Click **Garbage Collection** in the menu tree.
- 5) Click on the **Start/Stop Action** tab.
- 6) Click on **Start** followed by **OK**.

### 24.6.1.3 How to Stop the Garbage Collection Automatic Action (Deactivate)

#### *Prerequisites*

- You are logged into the WBM with the **Expert** profile.

#### *Step by Step*

- 1) In the navigation bar, click on **Expert Mode**.
- 2) Click **Maintenance > Actions** in the navigation tree.
- 3) Click on **Actions > Automatic Actions** in the menu tree. The names of all automatic actions are displayed in the menu tree. Disabled actions are flagged with a red bullet point. Enabled actions are flagged with a green bullet point.
- 4) Click **Garbage Collection** in the menu tree.
- 5) Click on the **Start/Stop Action** tab.
- 6) Click on **Stop** followed by **OK**.

## 24.6.2 DLS Notification Automatic Action

The automatic action DLS Notification can be used to initiate an automatic login at an external DLS server on starting up the communication system.

The color of the list item displayed in the menu tree indicates the status of the action (green = action activated, red = action not activated).

**Start/Stop Action** can be used to enable or start an inactive action (red list item) and to disable or stop an active action (green bullet point).

The automatic action DLS Notification is disabled by default.

### 24.6.2.1 How to Edit the DLS Notification Automatic Action

#### *Prerequisites*

- You are logged into the WBM with the **Expert** profile.

**Step by Step**

- 1) In the navigation bar, click on **Expert Mode**.
- 2) Click **Maintenance > Actions** in the navigation tree.
- 3) Click in the menu tree on **Actions > Automatic Actions > DLS Notification**.
- 4) Click on the **Edit Action** tab.

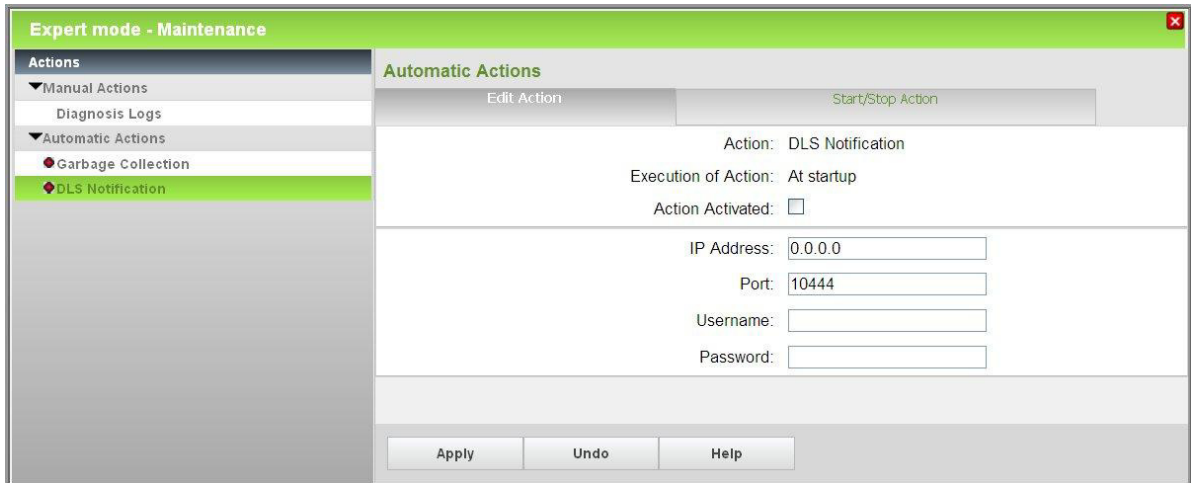

- 5) Select the desired setting.
  - If you want the DLS Notification action to be performed, select the **Action Activated** check box.
  - If you do not want the DLS Notification action to be performed, clear the **Action Activated** check box.
- 6) If appropriate, change the IP address of the external DLS server in the **IP Address** field.
- 7) If appropriate, change the port of the external DLS server in the **Port** field.
- 8) If appropriate, change the user name for logging on to the external DLS server in the **User name** field.
- 9) If appropriate, change the password for logging on to the external DLS server in the **Password** field.
- 10) Click on **Apply** followed by **OK**.

### 24.6.2.2 How to Start the DLS Notification Automatic Action (Activate)

**Prerequisites**

- You are logged into the WBM with the **Expert** profile.

**Step by Step**

- 1) In the navigation bar, click on **Expert Mode**.
- 2) Click **Maintenance > Actions** in the navigation tree.

- 3) Click on **Actions > Automatic Actions** in the menu tree. The names of all automatic actions are displayed in the menu tree. Disabled actions are flagged with a red bullet point. Enabled actions are flagged with a green bullet point.
- 4) Click **DLS Notification** in the menu tree.
- 5) Click on the **Start/Stop Action** tab.
- 6) Click on **Start** followed by **OK**.

### 24.6.2.3 How to Stop the DLS Notification Automatic Action (Deactivate)

#### *Prerequisites*

- You are logged into the WBM with the **Expert** profile.

#### *Step by Step*

- 1) In the navigation bar, click on **Expert Mode**.
- 2) Click **Maintenance > Actions** in the navigation tree.
- 3) Click on **Actions > Automatic Actions** in the menu tree. The names of all automatic actions are displayed in the menu tree. Disabled actions are flagged with a red bullet point. Enabled actions are flagged with a green bullet point.
- 4) Click **DLS Notification** in the menu tree.
- 5) Click on the **Start/Stop Action** tab.
- 6) Click on **Stop** followed by **OK**.

### 24.6.3 Warning Mechanism for SDHC card lifetime

The automatic action Warning Mechanism for SDHC lifetime is a way to get information about the SDHC cards health state with a filesystem check during startup. A WBM wizard starts and leads the technician through the process of setting a time when the system should make a restart and execute the check. All information is logged in the Customer Trace. The automatic action Warning Mechanism for SDHC is disabled by default.

---

**INFO:** This option triggers a system restart while prompting an Alert box "You will be logged off while restarting the system. The system, including the application board, if available, will be restarted. Please backup your data first to an external source."

---

WBM Home Screen recognizes two states:

- If the information from system is available a text will be presented in Home Screen informing about the general status of the card, **Card Health Status** (green, yellow, red or grey).  
Green health status means that the manufacturing date is less than 4 years ago for Toshiba cards or 10 years ago for Centon cards and there is no problem with the filesystem.  
Yellow health status means that the manufacturing date is more than 4 years ago for Toshiba cards or 10 years ago for Centon cards.  
Red health status means that filesystem errors exist, independent from the manufacturing date of the card.  
Grey health status means that the card is not supported or that it is not possible to retrieve card information. The SDHC card must be replaced by a supported type.
- If the information is not available then user will be prompted, **Card Health Status** unknown.

---

**NOTICE:** In case that the file system is corrupted the appropriate System SW image has to be downloaded from SWS and has to be copied to the SDHC card using the Card Manager Tool. After starting up the system with the new SDHC card, the configuration can be restored using the latest backup.

---

The text "**Card Health Status** " will also provide a link that will leads to the "Actions Page"

### 24.6.3.1 How to Start the Warning Mechanism for SDHC lifetime Automatic Action

#### **Prerequisites**

- You are logged into the WBM with the **Expert** profile.

#### **Step by Step**

- 1) Save the system with the Backup function to an external medium.
- 2) In the navigation bar, click on **Expert Mode**.
- 3) Click **Maintenance > Actions** in the navigation tree.
- 4) Click on **Actions > Automatic Actions** in the menu tree. The names of all automatic actions are displayed in the menu tree.
- 5) Click **SDHC Health Check** in the menu tree.  
Date and time of **Local System Time** and **Last Health Check** are displayed.
- 6) Select one of the following available options:
  - a) Start Health Check immediately.
  - b) Start Health Check on a specific date
- 7) Click on **Apply** followed by **OK**.

## 24.6.3.2 How to replace an SDHC Card

### Prerequisites

- You are logged on to the WBM with the **Advanced** profile.
- Only when using UC Suite: UC Suite has started correctly.
- Downgrade to previous software version is not supported. If a card with V2 software is installed, then only previous minor releases of V2 can be restored.
- The current Software version has to be used in order to avoid any side effect.

---

**INFO:** In case the SDHC card is broken and the system is down a previous backup should be used and the first 10 steps of the following procedure should be ignored.

---

### Step by Step

- 1) Click on **Backup and Restore** in the navigation bar.
- 2) In the navigation tree, click **Backup - Immediate**.
- 3) Enter a comment for the backup set in the **Comment** field so that the backup set can be easily identified if needed later for a restore. Avoid the use of diacritical characters such as umlauts and special characters in your input.
- 4) If you want to create a backup set including voice messages and announcements, select the **Full Backup** option.
- 5) Activate the target drive on which the backup set is to be saved in the **Devices** area.
- 6) Click on **OK & Next**. The progress of the backup process is displayed in a separate window.

---

**INFO:** If the **OK & Next** button is grayed out, then one or more applications (e.g., UC Suite) for which the data is to be saved were not started correctly.

If you do not have access rights for the selected archive directory, you will receive an error message. Select another destination drive or change the path for the archive.

An error message appears if there is not enough disk space on the destination drive for the backup set. If this occurs, select another destination drive or delete a backup set and restart the backup.

---

---

**INFO:** If you are using a USB device as a backup medium, wait till the LED of the USB device stops flashing. It is only then that the backup has been successfully stored on the USB device. You can then remove the USB device.

---

---

**INFO:** In addition to backup set, a text file associated with the backup set must also be saved. It contains information about the date and time of the backup and under which software version the backup was performed.

---

- 7) The backup was successful if the message **Backup completed successfully! 100%** appears.
- 8) If you have selected **HTTPS** as a backup medium, you must save the backup set and the text file associated with the backup to a location of your choice. This is done automatically for the other backup media. The browser window must remain open until the save operation for the backup set and text file has been completed.
- 9) Click on **Finish**.
- 10) Switch off the system.
- 11) Remove the existing SDHC card.
- 12) Install the new SDHC card.
- 13) Switch on the system.  
  
When a new SDHC card is installed, the software version included to the card with the default configuration is automatically installed to the system. After Startup, system will have its default IP address.
- 14) Click on **Backup and Restore** in the navigation bar.
- 15) Click **Restore** in the navigation tree.
- 16) Activate the medium containing the backup set to be restored in the **Devices** area.
- 17) If you activated **HTTPS** as the backup medium, navigate to the storage location of the backup set and select the backup set. Then navigate to the storage location of the text file and select it.
- 18) If you activated any other backup medium than **HTTPS**, select the backup set containing the configuration data to be restored in the List of available backup sets area.
- 19) Wait until the files have been loaded onto the system and then click **OK & Next**. The recovery of the configuration data is started. The progress of the restore process is displayed.
- 20) After the message **Restore complete!** appears, the system will automatically reboot. The restoration is completed successfully when the system is ready for use again.

---

**INFO:** After the restoration the device should be deleted from the RSP server and then to be reconfigured.

---

## 24.7 Power Management

Power management automatically switches the communication system to low power mode, depending on the system load. This reduces the energy consumption of the system and thus also contributes to environmental protection. The time period in which the system switches to low power mode can be set (e.g., at night).

Power management can be enabled only if the LAN interfaces of the system are in the Ethernet Link Mode **Auto**. In the low power mode, the LAN interfaces of the system automatically switch to the 100 Mbit/s full-duplex mode. The LAN interfaces of the connected infrastructure should also be in the autosense mode.

### Operating Modes

- **Active Mode**  
In active mode, the functions of the communication system are frequently used, and significant data transfers occur between the system and the connected infrastructure.
- **Idle Mode**  
In idle mode, the functions of the communication system are rarely used, and no significant data transfers occur between the system and the connected infrastructure. When a function is initiated, the system switches from idle mode to active mode.
- **Low Power Mode**  
Low-power mode has reduced energy requirements compared to the idle mode. The system operates in the 100 Mbit/s full-duplex mode.

It is also possible to operate the system permanently in the Ethernet Link Mode 100 Mbit/s full duplex or 100Mbit/s half duplex.

### 24.7.1 How to Enable or Disable the Power Management

#### *Prerequisites*

- The LAN interface of the mainboard, via which the system is connected to the LAN infrastructure, is set to the Ethernet Link Mode **Auto**.
- Only if a UC Booster Card is connected: the LAN interface of the UC Booster Card, via which the UC Booster Card is connected to the LAN infrastructure, is set to the Ethernet Link Mode **Auto**.
- The LAN interfaces of the connected infrastructure (e.g., IP phones) is set to autosense mode.
- You are logged on to the WBM with the **Advanced** profile.

#### *Step by Step*

- 1) In the navigation bar, click on **Setup**.
- 2) In the navigation tree, click **Wizards > Basic Installation**.

- 3) Click **Edit** to start the **Power Management** wizard.
- 4) If you want to enable the power management:
  - a) Select the **Power Management on/off** check box.
  - b) Under **Start of LowPowerMode** and **End of LowPowerMode**, enter the time span in which the communication system should switch to the low power mode.
- 5) If you want to disable the power management, clear the **Power Management on/off** check box.
- 6) Click on **OK & Next**. Your settings are applied.
- 7) Click on **Finish**.

## 24.7.2 How to Change the Ethernet Link Mode the LAN Interfaces

### Prerequisites

- You are logged into the WBM with the **Expert** profile.

### Step by Step

- 1) In the navigation bar, click on **Expert Mode**.
- 2) Click on **Telephony > Network Interfaces** in the navigation tree.
- 3) Select the Ethernet link mode for the LAN interface of the mainboard:
  - a) Click on **Mainboard > LAN 2** in the menu tree. The communication system is integrated in the LAN infrastructure via the LAN 2 port.
  - b) If you want to enable the power management, select the list item **Auto** from the **Ethernet Link Mode** drop-down list.
  - c) If you want to set the system to low power mode permanently, select the list item **100HDX** or **100FDX** from the **Ethernet Link Mode** drop-down list.

---

**INFO:** Power management cannot be enabled for the Ethernet link modes **100HDX**, **100FDX** and **1000FDX**.

---

- d) Click on **Apply**.
- 4) Only if a UC Booster Card is inserted: select the Ethernet Link Mode for the LAN interface of the UC Booster Card:
  - a) Click in the menu tree on **Application Board > LAN 2** or **LAN 1**, depending on which LAN interface was used to connect the UC Booster Card to the LAN infrastructure (indicated by the check mark in the **Interface Is Active** check box).
  - b) If you want to enable the power management, select the list item **Auto** from the **Ethernet Link Mode** drop-down list.



- c) If you want to set the system to low power mode permanently, select the list item **100HDX** or **100FDX** from the **Ethernet Link Mode** drop-down list.

---

**INFO:** Power management cannot be enabled for the Ethernet link modes **100HDX**, **100FDX** and **1000FDX**.

---

- d) Click on **Apply**.

## 24.8 Monitoring and Maintenance of OpenScape Business

OpenScape Business offers different functions for monitoring the current status of the system and for finding and resolving errors.

### 24.8.1 Checking the Network Connection of OpenScape Business X

The network connection between an OpenScape Business X communication system and the target address can be checked by using an ICMP (Internet Control Message Protocol) request.

Echo request packets can be sent via both the **Ping** and **Traceroute** functions. The corresponding echo reply messages are displayed together with the round-trip times.

The **Traceroute** function sends echo request packets with various incremental TTL (Time-To-Live) values.

#### 24.8.1.1 How to Ping

##### *Prerequisites*

- You are logged into the WBM with the **Expert** profile.

##### *Step by Step*

- 1) In the navigation bar, click on **Expert Mode**.
- 2) Click **Maintenance > IP Diagnostics** in the navigation tree.
- 3) Navigate in the menu tree to **IP Routing > ICMP Request > Ping**.
- 4) Enter the IP address of the desired target in the **Target Address** field.
- 5) In the field **Number of Echo Requests to Send**, enter the desired number (default value = 3).
- 6) Click on **Send**.

The acknowledgements will then be displayed together with the round trip delays.

## 24.8.1.2 How to Test the Trace Route

### *Prerequisites*

- You are logged into the WBM with the **Expert** profile.

### *Step by Step*

- 1) In the navigation bar, click on **Expert Mode**.
- 2) Click **Maintenance > IP Diagnostics** in the navigation tree.
- 3) Navigate in the menu tree to **Mainboard > ICMP Request > Trace route**.
- 4) Enter the IP address of the desired target in the **Target Address** field.
- 5) Enter the desired value (default value = 0) in the **TOS Byte** field.
- 6) Click on **Send**.

The acknowledgements will then be displayed together with the round trip delays.

## 24.8.2 SNMP (Simple Network Management Protocol)

The Simple Network Management Protocol (SNMP) is a network protocol which can be used to monitor and operate networking components (such as routers, servers, switches, printers, PCs) from a central station (management console). The protocol controls communication between the monitored components and the monitoring station.

SNMP describes the structure of data packets that can be sent and the communication procedure. SNMP was designed so that all network-capable devices can be included in monitoring. SNMP-based network management tasks include

- monitoring networking components,
- performing remote control and remote configuration of networking components,
- error detection and notification.

Devices known as "agents" are used for monitoring. These are utilities that run directly on monitored components. These utilities are able to record the status of components, make settings, and trigger actions. SNMP allows the central management console to communicate with the agents over a network.

---

**INFO:** OpenScope Business supports SNMPv2c, but also responds to SNMPv1 snmpget requests.

---

### **Management Information Databases (MIB)**

The volume of data that can be administered via SNMP is defined in MIBs (Management Information Base). MIBs are data models that describe the networking components to be administered in an established manner. The MIB of

the OpenScape Business X communication systems can be downloaded via the WBM (Service Center).

The communication systems have a separate SNMP agent that allows access to various system data that is stored in its MIB or Management Information Base. The MIB provides basic system information, status information, event-related data, and information on installed hardware (slots) and configured connections (ports).

SNMP supports the central monitoring and administration of networking components, including the communication systems themselves. It is possible to

- address the communication system over the TCP/IP protocol.
- access data over external management applications.
- perform remote maintenance activities.
- visualize the operating status of the communication system.
- transmit service-specific errors (Traps).

### **Communities**

Access to the SNMP data (MIBs) is governed by communities. A distinction is made here between read, write, and Trap communities. Each community has a specific IP address.

To enable read access to SNMP data (MIBs) on a PC, for example, the IP address of this PC must be entered in the list of read communities. To enable read and write access, the IP address must be entered in the list of write communities.

Trap Communities are used to manage the recipients of error messages (traps).

### **Traps**

When problems occur in a communication system, traps are generated to indicate errors and failures. The following types of traps are available:

- System traps = System errors that require immediate action for recovery.
- Performance Traps = Information on performance problems that do not require corrective action.

Traps are classified by their effects and can be retrieved by an administrator with the **Expert** profile using the WBM. A list of all traps received is displayed with the following information:

**Maintenance**

Monitoring and Maintenance of OpenScape Business

Table column	Meaning
VarBind1 (Severity)	Trap effect classes The following entries are possible: Critical: Error Message. This error causes problems. Major: error message. This error could cause problems. Minor: error message. The error has no problematic consequences. Warning: report of a possibly problematic procedure or status, but not an error message. Deleted Information: plain status messages, no error messages. Intermediate status Other traps
VarBind2 (Name)	Trap name
Generic Name	General Description such as Enterprise Specific, for example
Specific Name	Trap type (1 = software, 2 = hardware)
Enterprise	–
Time	Time of error
Index	List number

Trap display is updated every 30 seconds. Traps are sorted in the sequence of occurrence.

Trap details can be displayed by clicking a trap name.

SNMP Code	Event Log Entry	Meaning	Required Measures	Note
Error Class 01 - General Messages				
	System Restart	Hard restart (reset) of entire system with current CDB.	None	
FP_EVT_ADM_000	out of service of signed port on slot	out of service of signed port on slot		
FP_EVT_ADM_001	in service of signed port on slot	in service of signed port on slot		
FP_EVT_ADM_002	reload of signed slot	reload of signed slot		
FP_EVT_ADM_003	system restart	system restart		

SNMP Code	Event Log Entry	Meaning	Required Measures	Note
FP_EVT_ADM_007	SNMP out of service signed port on slot	SNMP out of service signed port on slot		
FP_EVT_ADM_008	SNMP in service signed port on slot	SNMP in service signed port on slot		
FP_EVT_ADM_009	SNMP reload signed slot	SNMP reload signed slot		
FP_EVT_ADM_010	SNMP System Restart	Hard restart of entire system via SNMP.	None	
FP_EVT_ADM_014	SNMP local DB changes	?On site? changes to the database.	None	
FP_EVT_ADM_015	SNMP remote DB changes	?Remote? changes to the database.	None	
FP_EVT_ADM_016	SNMP APSXF result	APS transfer acknowledgement message via SNMP.	None	
FP_EVT_ADM_017	SNMP authentication fail	Unauthorized access attempt.	Check firewall settings in OpenScape Business/ Manager E (Network ? Firewall).	
FP_EVT_ADM_018	SNMP 80 % high watermark of log-file	Changes logged internally in the system: 80 % of write capacity used.	Read out data using OpenScape Business/ Manager E (Transfer ? Security ? Protocol).	
FP_EVT_ADM_019	Sensor Alarm	Temperature in OpenScape Business housing is too high.	Check the fan and air supply in the 19? housing. Note the ambient temperature.	

## Maintenance

### Monitoring and Maintenance of OpenScape Business

SNMP Code	Event Log Entry	Meaning	Required Measures	Note
FP_EVT_ADM_020	CDR buffer limit reached	Overflow in the CDR buffer (CDR information).	Check that the interfaces (V.24, LAN), ports and the connection are functioning or read out call data.	
FP_EVT_ADM_021	Authentication Failure	Unauthorized access attempt.	Check firewall settings in OpenScape Business/ Manager E (Network ? Firewall).	
FP_EVT_ADM_022	Flash deleted	Flash area deleted.	None	APS transfer possible again.
FP_EVT_ADM_023	Process stopped	Process stopped.	Perform hard restart (reset).	
FP_EVT_ADM_024	unauthorized application	Attempted access via an unauthorized application.	Check firewall settings in OpenScape Business/ Manager E (Network ? Firewall).	
FP_EVT_ADM_025	manual switch-back from HiPath Manager			
<b>Error Class 02 - License Management Messages</b>				
FP_EVT_LIC_002	START Grace Period	HiPath License Management: Start of grace period.	None	The remaining license validity period is shown on the display.
FP_EVT_LIC_003	START Reg. Linc File	HiPath License Management: Start of regular licensing.	None	
<b>Error Class 09 - Hardware Module Messages</b>				

SNMP Code	Event Log Entry	Meaning	Required Measures	Note
FP_EVT_HW_000	microprocessor fault on, common	Microprocessor error.	Check power at the power supply unit.  If this error persists, replace the central control board.	
FP_EVT_HW_001	microprocessor fault off, common	The microprocessor error has been corrected.	None	
FP_EVT_HW_002	loadware memory fault on, common	Error in loadware memory.	Replace the board if necessary.	
FP_EVT_HW_003	loadware memory fault off, common	Error in loadware memory has been corrected.	None	
FP_EVT_HW_004	red alarm on-loss of multi-frame alignm.	red alarm on-loss of multi-frame alignm.		
FP_EVT_HW_011	SNTP-Client at PCS can't be activated	SNTP-Client at PCS can't be activated		
FP_EVT_HW_029	line interruption (error on)	Line interruption	Check the line and terminal.	
FP_EVT_HW_030	short circuit (error on)	Short circuit on the board specified.	Check the line, terminal, and port.	
FP_EVT_HW_031	under voltage (error on)	Under voltage.	Check the power and line at the terminal's power supply unit.	
FP_EVT_HW_032	thermal overload (error on)	The specified board is overheated.	Check the fan and air supply in the 19" housing. Note the ambient temperature.	
FP_EVT_HW_034	loss of frame on (STMD)	loss of frame on (STMD)		
FP_EVT_HW_035	loss of frame off (STMD)	loss of frame off (STMD)		

## Maintenance

### Monitoring and Maintenance of OpenScape Business

SNMP Code	Event Log Entry	Meaning	Required Measures	Note
FP_EVT_HW_036	slip detected on (STMD)	A bit slip has occurred on an ISDN line.	Check the S0 line. If necessary, reload the board or perform a hard restart. If the error persists, set up an ISDN trace.	The problem may be caused by asynchronous internal and external clock rates. Data loss possible/ connection may be terminated.
FP_EVT_HW_037	slip detected off (STMD)	The bit slip on the ISDN line has been corrected.	None	
FP_EVT_HW_038	alarm indication signal error on (TMS2M)	Alarm display: An S2M error has occurred. Physical line/board problem (too many CRC/SLIP errors).	Check the S2M line and board. Replace the board if necessary. If the error persists, set up an ISDN trace.	
FP_EVT_HW_039	alarm indication signal error off (TMS2M)	Alarm display: The S2M error has been corrected.	None	
FP_EVT_HW_040	degraded minute error on (TMS2M)	degraded minute error on (TMS2M)		
FP_EVT_HW_041	degraded minute error off (TMS2M)	degraded minute error off (TMS2M)		



SNMP Code	Event Log Entry	Meaning	Required Measures	Note
FP_EVT_HW_042	no signal error on (TMS2M/STMD)	Alarm display: An S2M error has occurred.  No physical connection available.	Check the S2M line and board.  If necessary, reload the board or perform a hard restart.  If the error persists, set up an ISDN trace.	
FP_EVT_HW_043	no signal error off (TMS2M/STMD)	Alarm display: The S2M error has been corrected.	None	
FP_EVT_HW_044	receive remote alarm error on (TMS2M)	Alarm display: An S2M error has occurred.  Physical problem with the communication partner (too many CRC/SLIP errors).	Check the board and partner system or arrange for a technician to do so.	
FP_EVT_HW_045	receive remote alarm error off (TMS2M)	Alarm display: The S2M error has been corrected.	None	
FP_EVT_HW_046	severely errored seconds error on(TMS2M)	severely errored seconds error on(TMS2M)		
FP_EVT_HW_047	severely errored seconds error of(TMS2M)	severely errored seconds error of(TMS2M)		

## Maintenance

### Monitoring and Maintenance of OpenScape Business

SNMP Code	Event Log Entry	Meaning	Required Measures	Note
FP_EVT_HW_048	bit slip error on (TMS2M)	A bit slip has occurred on an ISDN line.	Check the S2M line. If necessary, reload the board or perform a hard restart. If the error persists, set up an ISDN trace.	The problem may be caused by asynchronous internal and external clock rates. Data loss possible/ connection may be terminated.
FP_EVT_HW_049	bit slip error off (TMS2M)	The bit slip on the ISDN line has been corrected.	None	
FP_EVT_HW_050	loss of synchronization error on (TMS2M)	A synchronization error has occurred.	Check the S2M line. If necessary, reload the board or perform a hard restart. If the error persists, set up an ISDN trace.	The problem may be caused by asynchronous internal and external clock rates. Data loss possible/ connection may be terminated.
FP_EVT_HW_051	loss of synchronization error off (TMS2M)	The synchronization error has been corrected.	None	
FP_EVT_HW_052	clock can be used as ref. (TMS2M/STMD)	clock can be used as ref. (TMS2M/STMD)		
FP_EVT_HW_053	clock can not be used as reference	clock can not be used as reference		

SNMP Code	Event Log Entry	Meaning	Required Measures	Note
FP_EVT_HFP_EVT_HW_051W_058	Self test error on (SLMO)	Error while self-testing the specified SLMO board.	If necessary, replace the board or change the slot.	
FP_EVT_HW_059	Self test error off (SLMO)	Error while self-testing the specified SLMO board has been corrected.	None	
FP_EVT_HW_060	Access power feed error on (SLMO)	Access power feed error on (SLMO)		
FP_EVT_HW_061	Overcurrent on power controller on (SLMO)	Overcurrent on the specified SLMO board.	Check the power and line on the terminal and power supply unit.  Replace hardware if necessary.	
FP_EVT_HW_062	Overcurrent on power controller off (SLMO)	Overcurrent on the specified SLMO board has been corrected.	None	
FP_EVT_HW_063	ELIC error on (SLMO/SLMC)	ELIC error on (SLMO/SLMC)		
FP_EVT_HW_064	ELIC error off (SLMO/SLMC)	ELIC error off (SLMO/SLMC)		
FP_EVT_HW_065	Out of buffers for card error on	Insufficient pool capacity on the specified SLMO board.	Check lines and terminals. Set up a default trace.  High traffic load: -> Distribute load to several boards.  Board is faulty: -> Replace board.	
FP_EVT_HW_066	Out of buffers for card error off	Insufficient pool capacity on the specified SLMO board has been corrected.	None	
FP_EVT_HW_067	OCTAT error on (SLMC)	OCTAT error on (SLMC)		

## Maintenance

### Monitoring and Maintenance of OpenScape Business

SNMP Code	Event Log Entry	Meaning	Required Measures	Note
FP_EVT_HW_068	OCTAT error off (SLMC)	OCTAT error off (SLMC)		
FP_EVT_HW_096	unknown error from LW	unknown error from LW		
Error Class 11 - General Messages				
FP_EVT_DEV_041	L1 asynchron on	L1 asynchron on		
FP_EVT_DEV_042	L1 asynchron off	L1 asynchron off		
FP_EVT_DEV_043	Overload error on	Overload error on		
FP_EVT_DEV_044	Overload error off	Overload error off		
FP_EVT_DEV_045	Alive check error on	Alive check error on		
FP_EVT_DEV_046	optiPoint info	optiPoint info		
FP_EVT_DEV_048	Layer 2 error detected	Layer 2 error detected		
FP_EVT_DEV_049	Layer 3 error detected	Layer 3 error detected		
FP_EVT_DEV_052	Other errors	Other errors		
FP_EVT_DEV_057	NO TEI available	NO TEI available		
FP_EVT_DEV_058	Too many L1 errors	Too many layer 1 errors.	Check the lines, terminal, and port.  A short circuit may have occurred.	
FP_EVT_DEV_059	Access not configured	Access not configured		
Error Class 16 - Operating System Messages				
FP_EVT_GEN_001	Error in get pool element	Error in get pool element	Set up a trace using information from BLS (Back Level Support).  Create a stack dump.  Save a snapshot.	

SNMP Code	Event Log Entry	Meaning	Required Measures	Note
FP_EVT_GEN_002	Error in release pool	Error in release pool	Set up a trace using information from BLS (Back Level Support).  Create a stack dump.  Save a snapshot.	
FP_EVT_GEN_004	Error in OSF-Send	Error in OSF-Send	Set up a trace using information from BLS (Back Level Support).  Create a stack dump.  Save a snapshot.	
FP_EVT_GEN_005	Error in OSF-Timer	Error in OSF-Timer	Set up a trace using information from BLS (Back Level Support).  Create a stack dump.  Save a snapshot.	
FP_EVT_GEN_006	Error in OSF-Receive	Error in OSF-Receive	Set up a trace using information from BLS (Back Level Support).  Create a stack dump.  Save a snapshot.	
FP_EVT_GEN_007	General OSF error	General OSF error	Set up a trace using information from BLS (Back Level Support).  Create a stack dump.  Save a snapshot.	

## Maintenance

### Monitoring and Maintenance of OpenScape Business

SNMP Code	Event Log Entry	Meaning	Required Measures	Note
FP_EVT_GEN_009	Watch dog	Watch dog	Set up a trace using information from BLS (Back Level Support). Create a stack dump. Save a snapshot.	
FP_EVT_GEN_010	RESTARTED: manual Reset	RESTARTED: manual Reset	Set up a trace using information from BLS (Back Level Support). Create a stack dump. Save a snapshot.	
FP_EVT_GEN_011	RESTARTED: manual Reload	RESTARTED due to manual Reload	Set up a trace using information from BLS (Back Level Support). Create a stack dump. Save a snapshot.	
FP_EVT_GEN_012	RESTARTED: Power down	RESTARTED due to Power down	Set up a trace using information from BLS (Back Level Support). Create a stack dump. Save a snapshot.	
FP_EVT_GEN_013	KDS backup not performed	KDS backup not performed	Set up a trace using information from BLS (Back Level Support). Create a stack dump. Save a snapshot.	

SNMP Code	Event Log Entry	Meaning	Required Measures	Note
FP_EVT_GEN_014	RESTARTED: unknown rest. HW ind. mismatch	RESTARTED due to unknown rest. HW ind. mismatch	Set up a trace using information from BLS (Back Level Support).  Create a stack dump.  Save a snapshot.	
FP_EVT_GEN_015	general error logging	general error logging	Set up a trace using information from BLS (Back Level Support).  Create a stack dump.  Save a snapshot.	
FP_EVT_GEN_017	CTXT take over failed	CTXT take over failed	Set up a trace using information from BLS (Back Level Support).  Create a stack dump.  Save a snapshot.	
FP_EVT_GEN_020	CSTA: length out of range	CSTA: length out of range	Set up a trace using information from BLS (Back Level Support).  Create a stack dump.  Save a snapshot.	
FP_EVT_GEN_021	CSTA: Alloc() error	CSTA: Alloc() error	Set up a trace using information from BLS (Back Level Support).  Create a stack dump.  Save a snapshot.	

## Maintenance

### Monitoring and Maintenance of OpenScope Business

SNMP Code	Event Log Entry	Meaning	Required Measures	Note
FP_EVT_GEN_023	new APS not ok switch back	new APS not ok switch back	Set up a trace using information from BLS (Back Level Support). Create a stack dump. Save a snapshot.	
FP_EVT_GEN_024	idle arrived after restart	idle arrived after restart	Set up a trace using information from BLS (Back Level Support). Create a stack dump. Save a snapshot.	
FP_EVT_GEN_030	exceed. of CSTA mon. pts	exceed. of CSTA mon. pts	Set up a trace using information from BLS (Back Level Support). Create a stack dump. Save a snapshot.	
Error Class 19 - Network Services Messages				
FP_EVT_NWS_002	SNTP-Server not responding	No connection to the SNTP server.	Check the application and the connection.	
FP_EVT_NWS_011	SNTP-Client at PCS can't be activated	SNTP-Client at PCS can't be activated		
Error Class 20 - Call Processing Messages				
FP_EVT_CP_002	RS232: DSR not Ready	The RS232/V.24 interface is out of order.	Check the interface, the line, and the application.	
FP_EVT_CP_011	RS232: DSR ready	The RS232/V.24 interface is now operational.	None	



SNMP Code	Event Log Entry	Meaning	Required Measures	Note
FP_EVT_CP_013	not connected ways	The maximum number of connection paths permitted has been exceeded.	Use the project planning tool to test the system configuration.  Set up a trace using information from BLS.  Create a stack dump.  Save a snapshot.	
FP_EVT_CP_017	int. charg buf ovflw	Internal call data memory overflow.	Read out call data.  If the error persists, check the call data application interface.	
FP_EVT_CP_029	Forced trunk disconnection	Manual line release (for U.S. only).	None	
FP_EVT_CP_032	CDR Mem. alloc. failed	Advanced call data memory cannot be created.	System with MMC module: MMC module is faulty. Replace the MMC.  OpenScape Business: File system in flash is full or faulty.	
FP_EVT_CP_033	CDR Cache alloc. failed	Read cache for reading out CDR data cannot be created.	Perform a hard restart (normally occurs automatically).	This is caused by insufficient system memory capacity.
FP_EVT_CP_034	CDR Data write failed	Error while writing CDR data to the advanced call data memory.	MMC module: If necessary, read out call data via TFTP. The internal administration structure is also corrected, if this is required.	

**Maintenance**

## Monitoring and Maintenance of OpenScope Business

SNMP Code	Event Log Entry	Meaning	Required Measures	Note
FP_EVT_CP_035	CDR Adm. write failed	Error while writing the administration structure to the advanced call data memory.	MMC module: If necessary, read out call data via TFTP. After this, replace the MMC module.	
FP_EVT_CP_036	CDR Data read failed	Error while reading CDR data from the advanced call data memory.	Set up a trace using information from BLS. Create a stack dump. Save a snapshot.	
FP_EVT_CP_037	CDR Adm. read failed	Error while reading administration structure from the advanced call data memory.	Set up a trace using information from BLS. Create a stack dump. Save a snapshot.	
FP_EVT_CP_038	CDR Data detected	An advanced call data memory was found during system startup.	None	
FP_EVT_CP_039	CDR Data overflow	The advanced call data memory is full.	Read out call data.	
FP_EVT_CP_040	CDR Mem. allocated	The advanced call data memory was successfully created.	None	

SNMP Code	Event Log Entry	Meaning	Required Measures	Note
FP_EVT_CP_041	CDR Mem. released	The advanced call data memory was temporarily released.	None	This message is issued after the call data memory has been completely read out. It must be followed by the ?CDR Mem. allocated? message.
FP_EVT_CP_042	MMC-size	Output of MMC module size	None	During system startup, the size of the MMC module is read out and hexadecimally output in bytes 1 and 2 of the info bytes. Value ?00 10? describes the 16-MB MMC, value ?00 40? describes the 64-MB MMC. This does not apply to OpenScape Business.

## Maintenance

### Monitoring and Maintenance of OpenScope Business

SNMP Code	Event Log Entry	Meaning	Required Measures	Note
FP_EVT_CP_043	CDR-MMC MMC full	Memory on the MMC module or in the OpenScope Business file system is insufficient for creating the advanced call data memory.		
Error Class 21 - Device Handler Messages				
FP_EVT_DH_000	no dial tone detected	No dial tone detected.	Use headset to check dial tone.  Replace port or terminal if necessary.	
FP_EVT_DH_001	dial tone detected	Dial tone detected.	None	
FP_EVT_DH_004	Port out of service	Port out of service		
FP_EVT_DH_005	Port in service	Port in service		
FP_EVT_DH_007	Reference takt ON	Reference takt ON	None	
FP_EVT_DH_008	Reference takt OFF	Reference takt OFF	Check that the clock is available on the S0/S2M line.  If necessary, use OpenScope Business/Manager E to correct the clock?s allowed/denied numbers list (Trunk ? Clock parameters). If necessary, perform a reset.	
FP_EVT_DH_011	Fan Alarm ON	Fan error.	Check the fan and air supply in the 19? housing. Note the ambient temperature.	

SNMP Code	Event Log Entry	Meaning	Required Measures	Note
FP_EVT_DH_012	Fan Alarm OFF	The fan error has been corrected.	None	
FP_EVT_DH_013	No ack from temp. sensor	No response from temperature sensor.		
FP_EVT_DH_014	Overload at code receiver	Not enough DTMF receivers.	Use a larger system.	
FP_EVT_DH_015	Overload at code transmit.	Not enough DTMF transmitters.	Use a larger system.	
FP_EVT_DH_016	Name in S0/S2M msg discard	Name in S0/S2M msg discard		
FP_EVT_DH_017	msg to long L3S int->ext	msg to long L3S int->ext		
FP_EVT_DH_018	msg to long L3S ext->int	msg to long L3S ext->int		
FP_EVT_DH_019	Shorten Msg not successful	Internal error: An overlong ISDN message could not be shortened by deleting Facility IEs.	Set up a trace using information from BLS. Create a stack dump. Save a snapshot.	
FP_EVT_DH_020	Msg longer than pool elem.	Msg longer than pool elem.		
FP_EVT_DH_021	Msg too long for segm-disc		Msg too long for segm-disc	
FP_EVT_DH_022	Auto PRI detec DMS250 prot	Auto PRI detec DMS250 prot		
FP_EVT_DH_023	Auto PRI detect NI2 prot		Auto PRI detect NI2 prot	
FP_EVT_DH_024	Auto PRI detect 4ESS prot		Auto PRI detect 4ESS prot	
FP_EVT_DH_025	Name S0/S2M msg ext->int	Name S0/S2M msg ext->int		
FP_EVT_DH_026	key module overflow	key module overflow		
FP_EVT_DH_027	B-chan limit reached	B-chan limit reached		

## Maintenance

### Monitoring and Maintenance of OpenScape Business

SNMP Code	Event Log Entry	Meaning	Required Measures	Note
FP_EVT_DH_028	Power Alarm on	Emergency battery operation due to power outage.	Check line voltage. Note battery capacity.	
FP_EVT_DH_029	Power Alarm off	Power supply restored.	None	
FP_EVT_DH_093	si_cr_slot no logPort connected	si_cr_slot no logPort connected		
Error Class 23 - Device Handler Messages				
FP_EVT_NW_060	system hold, no buffer available	System hold, no more free buffer available.	Set up a trace using information from BLS. Create a stack dump. Save a snapshot.	
FP_EVT_NW_061	Check config rules for TMDID	For U.S. only: TMDID boards incorrectly configured.	Check TMDID board configuration using information from Pages 4-48 and correct if necessary.	
Error Class 26 - Board Administration Messages				
FP_EVT_PR_000	unknown card type	Unknown board.	System does not support the board type. Replace the board with a valid board type or remove it from the system.	The board may be too old or too new for the system.
FP_EVT_PR_001	card out of service	The specified board is out of order.	None	
FP_EVT_PR_002	card limit reached	The maximum number permitted for a certain board type is exceeded.	Reduce the number of boards of this board type. Note the maximum configuration.	

SNMP Code	Event Log Entry	Meaning	Required Measures	Note
FP_EVT_PR_003	other card type than old card type	Incompatible board type. The slot is already pre-assigned with a different board type.	Replace the board or use Assistant T to delete the pre-assigned board type so that the new board is recognized.	
FP_EVT_PR_004	card in service	The specified board is operational.	None	
FP_EVT_PR_005	error during database read	error during database read		
FP_EVT_PR_006	reason of reset card	reason of reset card		
FP_EVT_PR_007	Reload after load-LW-Code error	The specified board has been reloaded due to a startup error.	If this error persists, replace the board.	The board is reloaded due to a load error (length, checksum error) or a missing or delayed acknowledgement during startup.
<b>Error Class 28 - Recovery Messages</b>				
FP_EVT_RC_000	RESERVE	RESERVE	Set up a trace using information from BLS. Create a stack dump. Save a snapshot.	
FP_EVT_RC_004	SLC-Trace finished	SLC LW trace transferred to trace memory.	Trace memory can now be read out.	
FP_EVT_RC_005	X-trace output overflow	X-trace output overflow		

## Maintenance

### Monitoring and Maintenance of OpenScape Business

SNMP Code	Event Log Entry	Meaning	Required Measures	Note
FP_EVT_RC_006	Missing Timestamp in EventLog B	Missing Timestamp in EventLog B	None	A timestamp (current time and date) is entered when the event log B memory is copied. This facilitates analysis.
FP_EVT_RC_008	Missing APS in EventLog B	Missing APS in EventLog B	None	The current APS version is entered when the event log B memory is copied. This facilitates analysis.
Error Class 30 - Board Software Messages				
FP_EVT_LW_006	XCSEPBC: PBC error	PBC or ELIC error on the specified board.	Replace board.	
FP_EVT_LW_010	T1 reference clock problems		T1 reference clock problems	
FP_EVT_LW_016	HEATER ON - HXG3	Temperature in HiPath 3550/ HiPath 3350 wall housing is too high.	Check the fan kit and the air supply in the wall housing. Note the ambient temperature.	
FP_EVT_LW_017	HEATER OFF - HXG3	Temperature in HiPath 3550/ HiPath 3350 wall housing is normal.	None	
FP_EVT_LW_033	FAUC is reset	FAUC is reset		
FP_EVT_LW_061	short circuit on Upoe Port SLMC on	Short circuit in base station line.	Check lines. Replace base stations.	



SNMP Code	Event Log Entry	Meaning	Required Measures	Note
FP_EVT_LW_062	short circuit on Upoe Port SLMC off	Short circuit in base station line has been corrected.	None	
FP_EVT_LW_068	CMI base station breakdown off	CMI base station breakdown off		
FP_EVT_LW_069	CMI base station breakdown on	CMI base station breakdown on		
FP_EVT_LW_086	CMI base station overload	CMI base station overload		
FP_EVT_LW_090	E&M blocking information	E&M blocking information		
FP_EVT_LW_091	no message buffer on card avail. (1TR6)	no message buffer on card avail. (1TR6)		
FP_EVT_LW_092	message buffer on card available (1TR6)	message buffer on card available (1TR6)		
FP_EVT_LW_093	port not configured (1TR6)	port not configured (1TR6)		
FP_EVT_LW_094	unexpected message (1TR6)	unexpected message (1TR6)		
FP_EVT_LW_095	no USBS connection to system	no USBS connection to system		
FP_EVT_LW_0120	Layer 2 released	Layer 2 released		
FP_EVT_LW_0121	Layer 2 reestablished	Layer 2 reestablished		
FP_EVT_LW_0122	Layer 2 problem	Layer 2 problem		
FP_EVT_LW_0123	Layer 1 problem	Layer 1 problem		
FP_EVT_LW_0124	LW board error	LW board error		
FP_EVT_LW_0125	LW port error	LW port error		
Error Class 32 - Messages Concerning IVM (HiPath Xpressions Compact) and EVM (Entry Voice Mail)				
FP_EVT_SV_000	Configuration link up			
FP_EVT_SV_001	Configuration link down			
FP_EVT_SV_008	TIMEOUT during server-msg			

## Maintenance

### Monitoring and Maintenance of OpenScope Business

SNMP Code	Event Log Entry	Meaning	Required Measures	Note
FP_EVT_SV_010	IVM: Exception (unexpected error)	IVM: An unexpected error has occurred.	Set up an IVM trace.	
FP_EVT_SV_011	IVM: SW-error	IVM: A software error has occurred.	Set up an IVM trace. Upgrade IVM if necessary.	
FP_EVT_SV_012	IVM: SW-warning	IVM: SW-warning		
FP_EVT_SV_013	IVM: HD assignment of memory space 80%	IVM: 80% of hard disk used.	Search IVM statistics for mailboxes with too many undeleted messages.	
FP_EVT_SV_014	IVM: HD full	IVM: Hard disk is full.	Search IVM statistics for mailboxes with too many undeleted messages.	
FP_EVT_SV_015	IVM: Mailbox not available	IVM: Mailbox is not available.	Check whether the subscriber in question is available in the event log. Set up IVM system mailbox if necessary.	
FP_EVT_SV_016	IVM: SW_Upgrade not possible	IVM: Software upgrade is not possible.	Reload the board if necessary. Upgrade software again.	
FP_EVT_SV_017	IVM: Reload occurred	IVM: Reload performed.	None	
FP_EVT_SV_018	IVM: Restore faulty	IVM: Faulty restore.	Perform restore again.	
FP_EVT_SV_019	IVM: HD assignment of memory space <70 %	IVM: Hard disk load less than 70%.	None	

SNMP Code	Event Log Entry	Meaning	Required Measures	Note
FP_EVT_SV_020	IVM: Unauthorized call attempt	IVM: Unauthorized call attempt.	If the attempt is unintentional, deactivate the station number length.  If the attempt is intentional, create an IVM trace to determine the subscriber who made the attempt.	
FP_EVT_SV_030	VMM Cmd-resp timeout	EVM: Command response timeout.	Reload the board.  If the error persists, replace the board.	
FP_EVT_SV_031	memory level of 60%	memory level of 60%		
FP_EVT_SV_032	memory level of 80%	EVM: 80 % of memory used.	Check EVM mailboxes for too many undeleted messages.	
FP_EVT_SV_033	Presence evt from EVM	EVM: Presence Event from EVM.		
FP_EVT_SV_035	VMM unexp. EVM error	VMM unexp. EVM error		
FP_EVT_SV_036	EVM out of service	EVM out of service		
FP_EVT_SV_037	VMM config. Fault	VMM config. Fault		
FP_EVT_SV_038	VMM inconsistent msg	VMM inconsistent msg		
FP_EVT_SV_040	VMM no/unexp reaction	VMM no/unexp reaction		
FP_EVT_SV_041	VMM msg limit reached	EVM: Message limit reached.	Check EVM mailboxes for too many undeleted messages.	

## Maintenance

### Monitoring and Maintenance of OpenScope Business

SNMP Code	Event Log Entry	Meaning	Required Measures	Note
FP_EVT_SV_042	no language available	EVM: No language file available.	Check available languages on the EVM.  Load a language if necessary.	
FP_EVT_SV_043	VMM multiple greeting	VMM multiple greeting		
FP_EVT_SV_044	VMM buffer overflow	EVM: VMM buffer overflow.		
FP_EVT_SV_045	VMM no pool memory	VMM no pool memory		
FP_EVT_SV_046	EVM error during DM	EVM: EVM error during Data Mode.		
FP_EVT_SV_047	EVM error during FM	EVM error during FM		
FP_EVT_SV_048		DH_EVM error		
FP_EVT_SV_049	DH_EVM->reset EVM	EVM: System - DH_EVM -> reset EVM.		
FP_EVT_SV_052	AM com during DM	EVM: AM Command during Data Mode.		
FP_EVT_SV_053	Memory Full	EVM: Memory Full.		
FP_EVT_SV_055	No Pill File selected	EVM: No Pill File Selected.	Check available languages on the EVM.  Load a language if necessary.	
FP_EVT_SV_057	HW failure detected	HW failure detected		
FP_EVT_SV_058	Philips API ERROR	EVM: Philips API ERROR.		
FP_EVT_SV_059	I2C failure detected	EVM: I2C failure detected.		
FP_EVT_SV_070	EVM dir not available	EVM dir not available		
FP_EVT_SV_071	Daily Backup FS check failed	Daily Backup FS check failed		
FP_EVT_SV_072	wrong tar file	wrong tar file		

SNMP Code	Event Log Entry	Meaning	Required Measures	Note
FP_EVT_SV_073	invalid bin file	invalid bin file		
FP_EVT_SV_074	EVM memory full	EVM memory full		
FP_EVT_SV_075	inv. para from WBM	inv. para from WBM		
FP_EVT_SV_076	EVM checksum failure	EVM checksum failure		
Messages Concerning Resource Manager				
FFP_EVT_RM_000	Resource Manager error admin	Resource Manager error admin		
FP_EVT_RM_001	Resource Manager error configuration	Resource Manager error configuration		
Messages Concerning UPM				
FP_EVT_UPM_010	UPM: restarted	UPM: restarted		

SNMP Code	Event Log Entry	Meaning	Required Measures	Note
MSG_DLSC_BOOTSTRAP_OK	DLS client successfully bootstrapped.	DLS client successfully bootstrapped.		
MSG_STRC_STOP	Secure trace stopped.	Secure trace stopped.		
MSG_STRC_START	Secure trace started for protocols.	Secure traces have been activated by user for the mentioned protocols.		
MSG_SPE_CERT_MISSING	SPE certificate missing.	No SPE certificate installed.	Import SPE certificate plus private key (PKCS#12 file).	
MSG_SPE_CERT_AVAILABLE	SPE certificate available.	SPE certificate is now available.		
MSG_SPE_CERT_UPDATED	SPE certificate has been updated successfully.	SPE certificate has been updated successfully.		
MSG_SPE_CERT_EXPIRED	SPE certificate expired.	Validity period of installed SPE certificate is passed.	Install a new valid certificate.	

## Maintenance

### Monitoring and Maintenance of OpenScape Business

SNMP Code	Event Log Entry	Meaning	Required Measures	Note
MSG_SPE_CRL_EXPIRED	SPE CRL for a specific CA has been expired.	CDP inaccessible or retrieved CRL is expired.	Import a SPE CA certificate with valid CRLs configured in CDP.	
MSG_SPE_CRL_UPDATED	SPE CRL for CA has been updated successfully.	SPE CRL for CA has been updated successfully.		
MSG_SPE_ALL_CRLS_UPTODATE	All SPE CRLs are up to date again.	All SPE CRLs are up to date again.		
MSG_MIKEY_REBOOT	Mikey Stack: assertion failed.	Mikey Stack: assertion failed.		
MSG_IPSEC_REBOOT	Fatal error in IPsec stack.	Fatal error in IPsec stack.		
MSG_CAT_H323_REBOOT		Reboot with H.323		
MSG_CAT_HSA_REBOOT		Reboot with HAS		
MSG_GW_SUCCESSFULLY_STARTED				
MSG_IP_LINK_FAILURE				
MSG_IP_LINK2_FAILURE		IP-Link 1 up/down		
MSG_IP_LINK3_FAILURE				
MSG_WEBSERVER_MAJOR_ERROR				
MSG_NEW_SW_AVAILABLE				
MSG_ADMIN_REBOOT		Reboot with WBM/CLI-Admin, software upgrade or data restore		
MSG_SYSTEM_REBOOT		Automatic reboot, for example with Garbage Collection		
MSG_EXCEPTION_REBOOT		Reboot with SW exception		

SNMP Code	Event Log Entry	Meaning	Required Measures	Note
MSG_GW_OBJ_MEMORY_EXHAUSTED		Out of memory		
MSG_TLS_POOL_SIZE_EXCEEDED		No more internal pools		
MSG_OAM_RAM_THRESHOLD_REACHED		RAM limit reached		
MSG_OAM_DMA_RAM_THRESHOLD_REACHED		DRAM limit reached		
MSG_OAM_THRESHOLD_REACHED		Limit reached, for example, for flash memory or IP pools		
MSG_OAM_HIGH_TEMPERATURE_EXCEPTION		Temperature limit reached (too hot)		
MSG_FIREWALL_ALARM				
MSG_HACKER_ON_SNMP_PORT_TRAP		Unauthorized access to SNMP port		
MSG_DVMGR_LAYER2_SERVICE_TRAP		B channel up/down		
MSG_DVMGR_SECURED_LICENSE_FAILURE				
MSG_SSM_NUM_OF_CALL_LEGS_2BIG	More than 2 call Legs: not supported! CSID: %x/%x	No more than two call Legs per session are permitted. This has caused the software to become unstable. The necessary reboot is executed.		
MSG_SSM_SESSION_CREATION_FAILED	Session creation failed	Signalling is no longer possible because a session could not be created. The necessary reboot is executed. An SNMP trap is generated.		

## Maintenance

### Monitoring and Maintenance of OpenScope Business

SNMP Code	Event Log Entry	Meaning	Required Measures	Note
MSG_IPNCV_STARTUP_ERROR	IPNCV Startup: Creating IPNCV Manager failed	IPNCV could not be started. An SNMP trap is generated.	Create a TR/MR	
MSG_IPNCV_STARTUP_SHUTDOWN	IPNCV start/stop: IPNCV Manager created successfully or IPNCV start/stop: Shutdown of IPNCV Manager successfully	IPNCV was started or stopped successfully. An SNMP trap is generated		
MSG_IPNCV_INTERNAL_ERROR	Internal IPNCV error: %s	Software error: invalid internal data found. An SNMP trap will be generated with the profile IPNCV-Detailed.		
MSG_IPNCV_MEMORY_ERROR	IPNCV Memory: %s	Memory overflow: an SNMP trap is generated.	Restart the gateway. Create a TR/MR.	
MSG_IPNCV_SIGNALING_ERROR	IPNCV Signaling Error: %s	Software error: invalid internal data found.		
MSG_CAR_ALIVE_IP_CONNECTION_LOST	CAR : Alive : ip connection %d.%d.%d.%d lost	CAR: Alive: IP connection lost.		
MSG_LIC_DATA_ACCEPTED		License data accepted		
MSG_LIC_DATA_CORRUPTED		License data incomplete		
MSG_LIC_DATA_NOT_ACCEPTED		License data accepted		
MSG_VCAPI_ADD_OBJECT_FAILED				
MSG_VCAPI_COULD_NOT_DELETE_OBJECT				



SNMP Code	Event Log Entry	Meaning	Required Measures	Note
MSG_VCAPI_COULD_NOT_STORE_REQ				
MSG_KERNEL_REBOOT_EVENT				
MSG_SPE_CERT_MISSING	No SPE certificate installed!	SPE certificate missing.	Install SPE certificate.	

### 24.8.2.1 How to Display all Communities

#### *Prerequisites*

- You are logged into the WBM with the **Expert** profile.

#### *Step by Step*

- 1) In the navigation bar, click on **Expert Mode**.
- 2) Click **Maintenance > SNMP** in the navigation tree.
- 3) Click on **SNMP > Communities** in the menu tree. A list of all communities is displayed with the associated data (IP address, community, type).

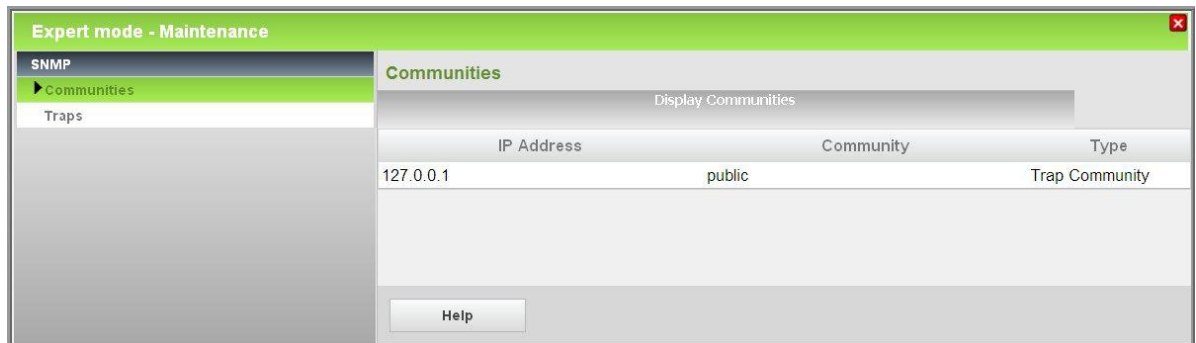

### 24.8.2.2 How to Add a Community

#### *Prerequisites*

- You are logged into the WBM with the **Expert** profile.

#### *Step by Step*

- 1) In the navigation bar, click on **Expert Mode**.
- 2) Click **Maintenance > SNMP** in the navigation tree.
- 3) Select the desired community.

## Maintenance

Monitoring and Maintenance of OpenScape Business

- If you want to add a Read Community, click **SNMP > Communities > Read Communities** in the menu tree. Click on the **Add Read Community** tab.
  - If you want to add a Write Community, click **SNMP > Communities > Write Communities** in the menu tree. Click on the **Add Write Community** tab.
  - If you want to add a Trap Community, click **SNMP > Communities > Trap Communities** in the menu tree. Click on the **Add Trap Community** tab.
- 4) Enter the IP address of the new community in the **IP Address** field.
  - 5) Enter the name of the new community in the **Community** field.
  - 6) Click on **Apply** followed by **OK**.

### 24.8.2.3 How to Edit a Community

#### *Prerequisites*

- You are logged into the WBM with the **Expert** profile.

#### *Step by Step*

- 1) In the navigation bar, click on **Expert Mode**.
- 2) Click **Maintenance > SNMP** in the navigation tree.
- 3) Navigate in the menu tree under **SNMP > Communities > ...** down to the desired community.
- 4) Click on the **Edit Community** tab.
- 5) Edit the community.
- 6) Click on **Apply** followed by **OK**.

### 24.8.2.4 How to Delete a Community

#### *Prerequisites*

- You are logged into the WBM with the **Expert** profile.

#### *Step by Step*

- 1) In the navigation bar, click on **Expert Mode**.
- 2) Click **Maintenance > SNMP** in the navigation tree.
- 3) Navigate in the menu tree under **SNMP > Communities > ...** down to the desired community.
- 4) Click on the **Delete Community** tab.
- 5) Click on **Delete** followed by **OK**.

## 24.8.2.5 How to Display Traps

### Prerequisites

- You are logged into the WBM with the **Expert** profile.

### Step by Step

- In the navigation bar, click on **Expert Mode**.
- Click **Maintenance > SNMP** in the navigation tree.
- Click on **SNMP > Traps** in the menu tree.
- Select one of the following options:
  - If you want a list of all traps to be displayed, click the **Display All Traps** tab.

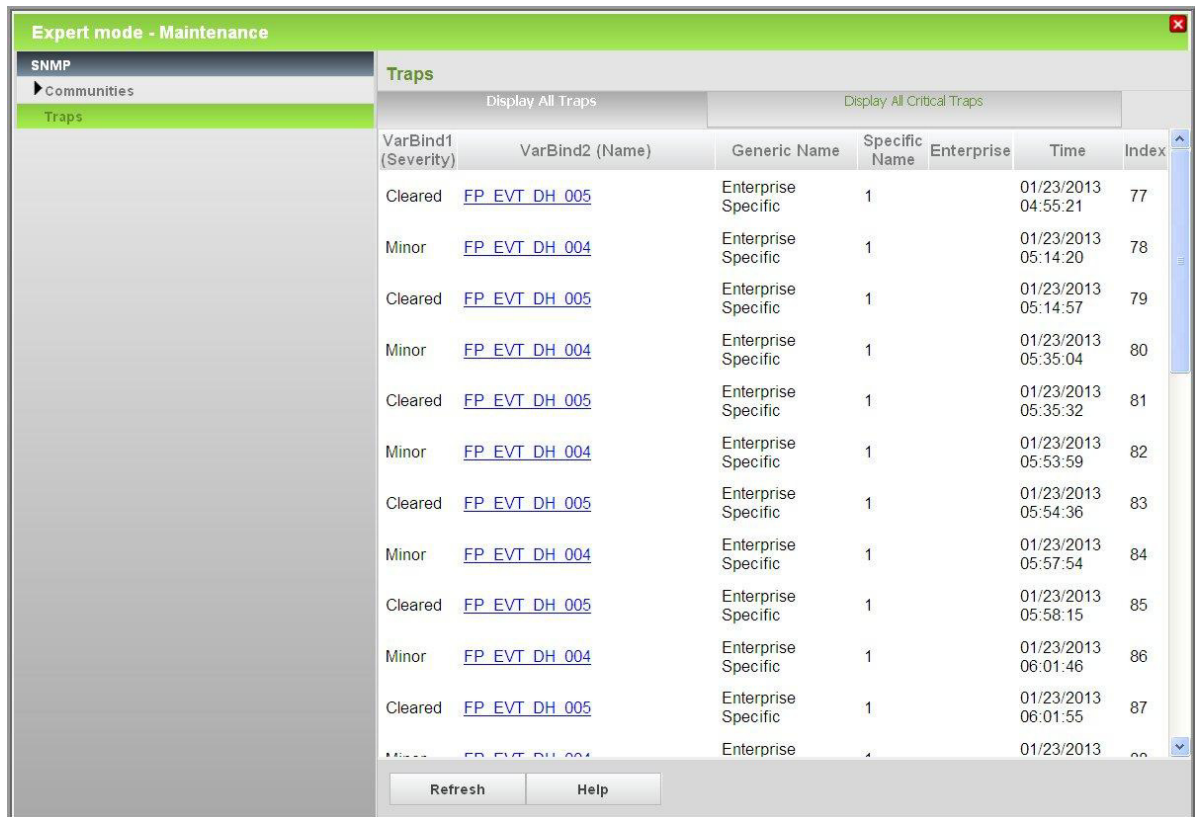

Expert mode - Maintenance						
SNMP						
Communities						
Traps						
Display All Traps			Display All Critical Traps			
VarBind1 (Severity)	VarBind2 (Name)	Generic Name	Specific Name	Enterprise	Time	Index
Cleared	<a href="#">FP EVT DH 005</a>	Enterprise Specific	1		01/23/2013 04:55:21	77
Minor	<a href="#">FP EVT DH 004</a>	Enterprise Specific	1		01/23/2013 05:14:20	78
Cleared	<a href="#">FP EVT DH 005</a>	Enterprise Specific	1		01/23/2013 05:14:57	79
Minor	<a href="#">FP EVT DH 004</a>	Enterprise Specific	1		01/23/2013 05:35:04	80
Cleared	<a href="#">FP EVT DH 005</a>	Enterprise Specific	1		01/23/2013 05:35:32	81
Minor	<a href="#">FP EVT DH 004</a>	Enterprise Specific	1		01/23/2013 05:53:59	82
Cleared	<a href="#">FP EVT DH 005</a>	Enterprise Specific	1		01/23/2013 05:54:36	83
Minor	<a href="#">FP EVT DH 004</a>	Enterprise Specific	1		01/23/2013 05:57:54	84
Cleared	<a href="#">FP EVT DH 005</a>	Enterprise Specific	1		01/23/2013 05:58:15	85
Minor	<a href="#">FP EVT DH 004</a>	Enterprise Specific	1		01/23/2013 06:01:46	86
Cleared	<a href="#">FP EVT DH 005</a>	Enterprise Specific	1		01/23/2013 06:01:55	87
Minor	<a href="#">FP EVT DH 004</a>	Enterprise Specific	1		01/23/2013 06:01:55	88

- If you want a list of all critical traps to be displayed, click the **Display All Critical Traps** tab.

## 24.8.2.6 How to Display Details of a Trap

### Prerequisites

- You are logged into the WBM with the **Expert** profile.

## Maintenance

Monitoring and Maintenance of OpenScape Business

### Step by Step

- 1) In the navigation bar, click on **Expert Mode**.
- 2) Click **Maintenance > SNMP** in the navigation tree.
- 3) Click on **SNMP > Traps** in the menu tree.
- 4) Click on the **Display All Traps** tab. A list of all traps is displayed with the associated data.
- 5) Click on the name of the desired trap. The details of that trap will be displayed.
- 6) Click on the **Display All Traps** tab to open the list of all traps once more.

## 24.8.3 Manual Actions

Many different logs (diagnostics data and diagnosis logs) can be loaded via manual actions.

Administrators with the **Advanced** profile can load diagnostic data (diagnosis logs) by using the **Trace** wizard.

Administrators with the **Expert** profile can load diagnostic data (diagnosis logs) in **Expert mode**.

The following logs can be loaded:

Protocol	Explanation	Application case
Trace log	Standard trace file, if trace profiles have been activated. A selection can be made between the following options: <ul style="list-style-type: none"><li>• <b>Complete Trace Log</b>: The full set of existing system trace log files is downloaded.</li><li>• <b>Log from Today</b>: The system trace log files of the current day (as of 00:00 hours) are downloaded.</li><li>• <b>Own Selection: From: XXX To: YYY</b>: The system trace log files of the selected time period are downloaded.</li></ul>	No special application
Event Log	Actions/events of the communication system (Reset, On/Off, etc.)	No special application
Admin log (also called admin protocol)	Messages about administration processes at the communication system (login attempts, etc.)	No special application
License Protocols	Messages about the communication system components that require licenses	Problems with licensing (the license file cannot be activated, and so on)
Customer Trace	Messages for the customer trace are provided in a more detailed format than in the trace log, for example (remote login, ITSP login, etc.).	Problems with the ITSP (Internet Telephony Service Provider) connection or the remote login
Framework Protocol	WBM messages	Problems with licensing, backup, restore or with the WBM

Protocol	Explanation	Application case
Diagnosis Log	Diagnosis logs of the communication system (FP/LDH)	System crash or uncontrolled shutdown of the communication system
UC Suite Logs	<p>Messages of the UC Suite of the communication system (UC Suite, CSP and MEB logs)</p> <p>A selection can be made between the following options:</p> <ul style="list-style-type: none"> <li>• <b>Complete Trace Log:</b> All existing UC Suite, CSP and MEB log files are downloaded.</li> <li>• <b>Log from Today:</b> The UC Suite, CSP and MEB log files of the current day (as of 00:00 hours) are downloaded.</li> <li>• <b>Own Selection: From: XXX To: YYY:</b> The UC Suite, CSP and MEB log files of the selected time period are downloaded.</li> </ul> <p>All log files are archived together in a compressed file. The following file naming conventions apply to the OpenScape Business logs: UC Suite log files = vs_YYYY_mm_dd.log, CSP log files = cspttrace_YYYY_mm_dd.log, MEB log files = mebtrace_YYYY_mm_dd.log.</p> <p><b>INFO:</b> diagnostic data can be downloaded only when operating with the UC Booster Card OCAB. When using the OpenScape UC Business Booster Server, diagnostic data must be downloaded from the server itself.</p>	Problems with the UC Suite and/or the client (myPortal for Desktop, myAttendant, etc. )
Application Protocols	<p>Messages of the application side of the communication system (for example, CSP protocols)</p> <p>An administrator with the <b>Expert</b> profile can select between the following options in <b>Expert Mode</b>:</p> <ul style="list-style-type: none"> <li>• <b>Complete Trace Log:</b> All existing log files are downloaded</li> <li>• <b>Log from Today:</b> The log files of the current day (as of 00:00 hours) are downloaded.</li> <li>• <b>Own Selection: From: XXX To: YYY:</b> The log files of the selected time period are downloaded.</li> </ul> <p>All log files are archived together in a compressed file.</p>	Problems with the application side of the communication system
System Diagnosis Logs	Diagnosis logs of the communication system	No special application
PPP Logs	Messages for the Point-to-Point Protocol	Problems with Dial-In or Dial-Out connections
CoreLog Protocol	CoreLogs are created for resets, etc. (e.g., memory dumps at a PC).	System crash or uncontrolled shutdown of OpenScape Business

After the desired logs have been selected, a compressed file is created and stored in a specified directory.

## Maintenance

Monitoring and Maintenance of OpenScape Business

### 24.8.3.1 How to Download Diagnostics Data / Diagnosis Logs

The **Trace** wizard can be used to download diagnostics data (diagnosis logs) for the communication systems.

#### Prerequisites

- You are logged on to the WBM with the **Advanced** profile.

#### Step by Step

- 1) Click on **Service Center** in the navigation bar.
- 2) Click **Diagnostics > Trace** in the navigation tree.
- 3) Click on **Diagnosis Logs**.

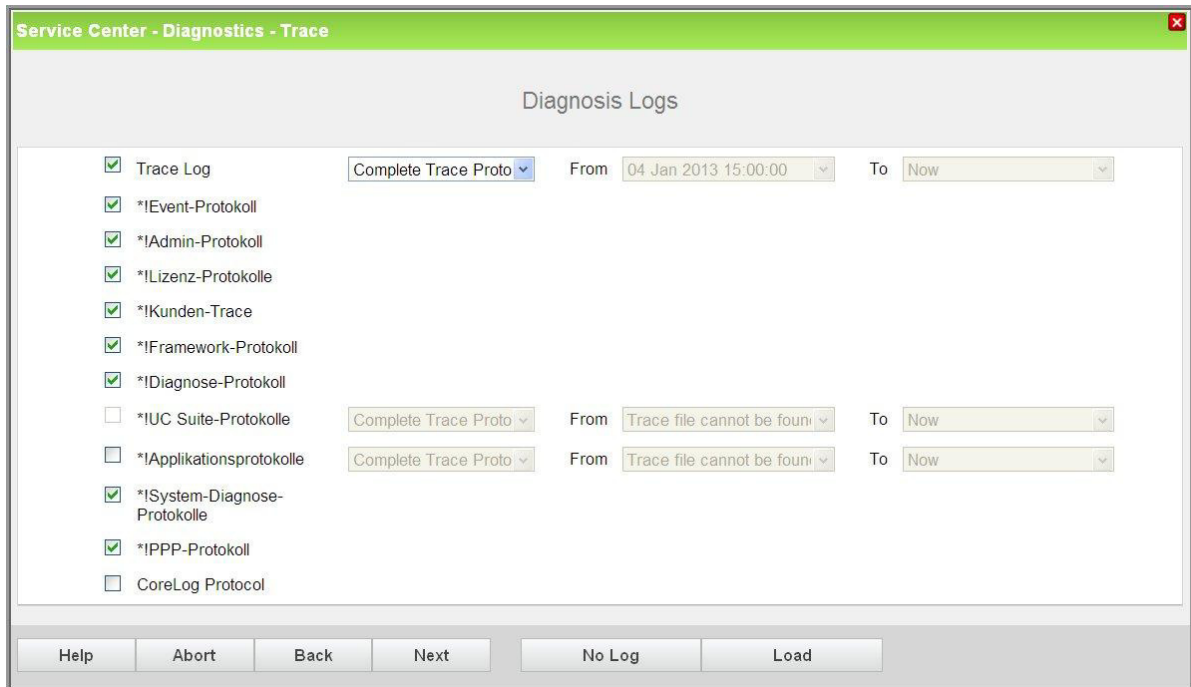

- 4) Select the check boxes of the logs you want to download. Clear the check boxes of the logs you do not want to download.
- 5) Click on **Load** followed by **OK**. The File Download window appears.
- 6) Save the file in the desired directory. Then close the window that confirms the download of the file.
- 7) Click on **Next** followed by **Finish**.

### 24.8.4 Traces

Traces can be used to record the execution of individual program steps and their results during the execution of a program. In combination with further diagnostics data, an incorrectly executing program can be traced back to the source of the

error. The individual traces to be recorded and their respective levels of detail are configured via the trace profiles and trace components.

---

**INFO:** Activating traces can have a negative impact on system performance and must hence only be performed by experienced administrators and only after consulting with the responsible Service Support.

The console trace, in particular, requires substantial system resources and thus has an adverse effect on the performance of the communication system.

---

## Networking

In order to diagnose networked communication systems, the trace data of each individual node must be collected separately. It is not possible to acquire the trace data of networked communication systems centrally.

### Trace Format Configuration

The Trace Format Configuration function can be used by an administrator with the **Expert** profile to define which header data is to be included in the trace output and how the trace data is to be formatted.

Header data for the trace output (all options are activated in the default setting):

- Global Trace Header Format Settings  
If this option is enabled, the options for the following header data can be activated or deactivated.
- Subsystem ID
- Task Name
- Task ID
- Time
- Module Name
- Line Number

#### Formatting the Trace Data

- Full formatting with parameter expansion (default) = large data volume, normal trace performance. Default setting
- Limited formatting (message types binary, special X-Tracer format) = medium data volume, fast trace performance.
- Limited formatting (expansion of basic data types only) = low data volume, very trace performance.
- Performance optimized trace without parameter expansion = very low data volume, extremely fast trace performance.

---

**INFO:** Note that adding more trace header data and extensive trace data formatting will decrease the overall trace performance.

---

## Maintenance

### Monitoring and Maintenance of OpenScape Business

#### Trace output interfaces

This function enables an administrator with the **Expert** profile to define the interfaces for the trace output. It is possible to either enable the file trace or trace via LAN or to disable both interfaces.

Trace output interface	Explanation	Default setting
File Trace	<p><b>Switch File Trace On</b></p> <p>Trace messages are entered into a log file in the communication system.</p> <p>The following settings apply when the option is enabled:</p> <p><b>Max. Trace Quota (kByte):</b> Indicates the maximum size of the trace memory</p> <p><b>Policy to handle reach of max. quota.</b> You can choose between <b>Wrap Around (delete oldest file)</b> and <b>Stop temporarily the file trace.</b></p> <p><b>Time between creation of new trace files (sec):</b> 900</p> <p><b>Time period for which trace files are available:</b> The actual time period is specified.</p>	Enabled
Trace via LAN	<p><b>Switch Trace via LAN On</b></p> <p>Trace messages are transmitted via the LAN interface.</p> <p>The following setting applies when the option is enabled: <b>Timer value</b> = 25 sec. (delay period until data is transmitted.)</p>	Not activated

#### Trace log

If the trace output interface Switch File Trace On is enabled, the resulting log files can be transferred by an administrator with the **Expert** profile to a PC or deleted.

#### Digital Loopback

Digital loopbacks are used to test the B channels of S<sub>0</sub>, S<sub>2M</sub> and T1 interfaces of any existing boards. Digital loopbacks should only be activated if requested by the service provider.

They can only be configured using E Manager.

#### Event Viewer / Customer Trace Log

The **Event Viewer** wizard can be used by an administrator with the **Advanced** profile to start the event display (customer trace) In addition, the customer trace log file can be copied to a PC or deleted.

The following functions, which can be started using the wizard, are described here:



- [How to Display or Edit Event Viewer and Customer Trace Logs](#)
- [How to Download or Open the Event Viewer Log / Customer Trace Log](#)
- [How to Clear the Event Viewer Log / Customer Trace Log](#)

Administrators with the **Expert** profile can start displaying the customer trace log file in **Expert mode**. In addition, the customer trace log file can be copied to a PC or deleted.

### **M5T Trace Components**

This function is used to monitor the SIP stack by an administrator with the **Expert** profile. For each M5T trace component, the level of detail for the trace can be defined via trace levels (0 = lowest level of detail to 4 = maximum level of detail).

### **Secure Trace**

This function is used by an administrator with the **Expert** profile to record encrypted VoIP payload and signaling data streams.

If the Signaling and Payload Encryption (SPE) feature has been enabled, the VoIP payload and signaling data streams from and to the communication system and between IP phones will be encrypted.

To ensure that errors are properly analyzed, additional trace information (**Secure Trace**) can be transmitted in the LAN for a limited period of time. In this case, asymmetrically encrypted secure trace files are generated, which can only be decrypted and analyzed by Development.

The following security features have been implemented to restrict the use of the secure trace function:

- A service technician must import a so-called public key (certificate) into the relevant communication system. The certificate is part of an X.509 file and is required to generate a secure trace. The X.509 file is provided by Development. The included certificate is valid for a maximum of one month.
- A special password (passphrase) must be entered to start and stop the secure trace. This password is known only to the customer.

Thus, the certificate is the key of the service technician and the password (passphrase) is the key of the customer. Both keys are required to activate the secure trace function.

Process for generating a secure trace:

1. A service technician finds a problem in the customer's LAN. Together with Development, the service technician recognizes the need to generate a secure trace.
2. The customer is notified accordingly and must confirm that he has been notified. The customer then issues an order for the creation of a secure trace, specifying the date and time when monitoring should start and end.
3. A developer creates a key pair consisting of the public key and the private key. This key pair can only be used to create a single secure trace. The certificates are used in the following manner

## Maintenance

### Monitoring and Maintenance of OpenScape Business

- The certificate with the private key is strictly confidential and can only be used by authorized developers.  
The private key is required to decrypt the secure trace files.
  - The certificate with the public key is passed to the service technician in the form an X.509 file in PEM or binary format.  
This certificate must be imported into the relevant communication system to be able to generate a secure trace.
4. The service technician notifies the customer that the generation of the secure trace is to start soon. The customer, in turn, must notify all affected parties.

---

**NOTICE:** The live recording of calls and connection data is a criminal offence, unless the affected parties have been notified in advance.

---

5. The service technician imports the certificate with the public key into the relevant communication system.
6. The customer starts the secure trace by entering the password (passphrase).  
The secure trace files are generated.  
Start and stop of the secure trace are logged by the communication system.
7. Upon completion of secure trace generation, the customer is notified that all secure trace activities have been stopped. The service technician removes the certificate from the communication system.
8. The secure trace files are made available to Development.
9. A developer decrypts the secure trace files using the private key and then analyzes the decrypted data.

---

**NOTICE:** Once the analysis has been completed, all relevant data must be destroyed in a secure manner. This includes the destruction of the private key so that any potential unauthorized copy of the secure trace files can no longer be decrypted.

---

#### H.323 Stack Trace

This function can be used by an administrator with the **Expert** profile to set the H.323 Stack Trace Configuration. The level of detail for the trace can be defined via trace levels (0 = lowest level of detail to 4 = maximum level of detail). The following settings can be selected for the H.323 stack trace output:

Trace output interface	Explanation	Default setting
Console Trace	<p><b>Switch Console Trace On</b></p> <p>H.323 Stack Trace messages are output on the console.</p>	Not activated
File Trace	<p><b>Switch File Trace On</b></p> <p>H.323 Stack Trace messages are written to a log file.</p> <p>The following settings apply when the option is enabled:</p> <p>Max. size of the trace buffer = 50000 bytes (amount of data stored in the buffer.)</p> <p>Max. size of the trace file = 1000000 bytes (maximum size of the log file.)</p> <p>Trace Timer = 60 sec. (delay period until data is written to the log file.)</p>	Not activated

By activating and/or deactivating H.323 modules, you can define for which components of the H.323 stack trace the process and status information is to be recorded. The status of each H.323 module is indicated by the color of the associated bullet point (green = H.323 module active, red = H.323 module inactive).

The H.323 Stack Trace log can be transmitted to a PC or deleted.

### License Component Trace

This function is used by an administrator with the Expert profile to monitor the system-internal license agent (Customer License Agent, CLA). The level of detail for the trace can be defined via trace levels (low = lowest level of detail (default), standard = medium level of detail, all = maximum level of detail).

By default, the license component trace is enabled (trace level = low).

Changing the trace level can have a negative impact on system performance and must hence only be performed by experienced administrators and only after consulting with the responsible Service Support.

### Trace Profiles

Trace profiles define what data is to be recorded and at what level of detail. Trace components are assigned to a trace profile. This allows you to specify for which system components the process and status information should be logged by the trace profile.

Predefined trace profiles are provided for all standard scenarios. In addition, an administrator with the **Expert** profile can also create his or her own profiles. When you start a trace profile, logging is activated via this profile. When you stop the profile, logging is deactivated.

- Administrators with the **Advanced** profile can start and/or stop trace profiles by using the **Trace** wizard. The status of every trace profile is indicated by the

## Maintenance

### Monitoring and Maintenance of OpenScope Business

color of the associated list item (green = trace profile active, red = trace profile not active). **Start/Stop** can be used to enable or start an inactive trace component (red bullet point) and to disable or stop an active trace component (green bullet point).

**Load Trace** is used to transfer the generated log files to a PC or open them.

**Delete Trace** is used to delete the generated log files.

The following functions, which can be started using the wizard, are described here:

- [How to Download a System Trace Log File](#)
  - [How to Delete a System Trace Log File](#)
  - [How to Display all Trace Profiles](#)
  - [How to Start or Stop a Trace Profile](#)
  - [How to Download Diagnostics Data / Diagnosis Logs](#)
- Administrators with the **Expert** profile can collectively stop all trace profiles and selectively start and/or stop individual trace profiles in **Expert mode**. In the menu tree display, the color of the list item indicates the status of the trace profile (green = trace profile is activated, red = trace profile is not activated). **Start/Stop Trace Profile** can be used to enable or start an inactive trace component (red bullet point) and to disable or stop an active trace component (green bullet point).

By selecting **Display Trace Profile** you can view the details of the desired trace profile: This includes the profile name, details about write protection and the status of the profile, as well as information on when, i.e., for which problems, this trace profile should be used. In addition, you can see which trace components belong to the trace profile.

Trace Profile	Application case
Actors / Sensors / Door Opener	No information is currently available!
Basic	No information is currently available!
Calls_with_Analog_Subscriber_Trunks	No information is currently available!
Calls_with_ISDN_Subscriber_Trunks	No information is currently available!
Calls_with_System_Device_HFA	No information is currently available!
Calls_with_System_Device_Upn	No information is currently available!
CDR_Charging_data	No information is currently available!
CMI	No information is currently available!
CSTA_application	No information is currently available!
Display_problems	No information is currently available!
Gateway_Stream_detailed	No information is currently available!
Gateway_Stream_overview	No information is currently available!
IP_Interfaces	No information is currently available!
License_problem	No information is currently available!
Network_Call_Routing_LCR	No information is currently available!
Peripheral_cards	No information is currently available!

Trace Profile	Application case
RAS_or_Internal_access	No information is currently available!
Resources_MOH_Conferencing	No information is currently available!
SIP_Interconnection_Subscriber_ITSP	No information is currently available!
SIP_Registration	No information is currently available!
Smart_VM	No information is currently available!
UC_Smart	No information is currently available!
Voice_fax_connection	No information is currently available!
VPN	No information is currently available!
Web_based_Assistant_Expert_Mode	No information is currently available!
Xpressions Compact	No information is currently available!

### Trace Components

Trace components can be used to record the process and status information of individual components of the communication system.

All trace components can be stopped together and started or stopped individually by an administrator with the **Expert** profile. Starting and stopping a trace component activates and deactivates the recording. The level of detail for the trace can be defined via trace levels (0 = lowest level of detail to 9 = maximum level of detail).

The color of the list item displayed in the menu tree indicates the status of the trace component (green = trace component activated, red = trace component not activated). **Start/Stop Trace Component** can be used to enable or start an inactive trace component (red bullet point) and to disable or stop an active trace component (green bullet point).

A Trace Component display shows the subsystem name, the trace component index, the set trace level, the status information and whether or not the trace component is currently active. If a trace component needs to be edited, apart from changing the trace level, the trace component can also be started or stopped.

#### 24.8.4.1 How to Download a System Trace Log File

The **Trace** wizard can be used to download system trace log files.

##### **Prerequisites**

- You are logged on to the WBM with the **Advanced** profile.

##### **Step by Step**

- 1) Click on **Service Center** in the navigation bar.
- 2) Click **Diagnostics > Trace** in the navigation tree.
- 3) Click on **Diagnosis Logs**.

## Maintenance

### Monitoring and Maintenance of OpenScape Business

- 4) Click on **No Log** to clear the check boxes of all logs.
- 5) Enable the **Trace Log** check box.
- 6) Select one of the following options:
  - If you want to download the entire system trace log, select **Complete Trace Log** in the drop-down list.
  - If you want to download the system trace log for today, select **Log from Today** in the drop-down list.
  - If you want to download the system trace log for a specific time period, select **Own Selection** in the drop-down list. Then, select the beginning and end of the desired time period in the drop-down lists **From:** and **To:**.
- 7) Click on **Load** followed by **OK**. The File Download window appears.
- 8) Save the file in the desired directory. Then close the window that confirms the download of the file.
- 9) Click on **Next** followed by **Finish**.

#### 24.8.4.2 How to Delete a System Trace Log File

The **Trace** wizard can be used to delete system trace log files.

##### *Prerequisites*

- You are logged on to the WBM with the **Advanced** profile.

##### *Step by Step*

- 1) Click on **Service Center** in the navigation bar.
- 2) Click **Diagnostics > Trace** in the navigation tree.
- 3) Click on **Delete Trace** followed by **OK**.
- 4) Click on **Next** followed by **Finish**.

#### 24.8.4.3 How to Display all Trace Profiles

The **Trace** wizard can be used to obtain information on the status of all trace profiles.

##### *Prerequisites*

- You are logged on to the WBM with the **Advanced** profile.

##### *Step by Step*

- 1) Click on **Service Center** in the navigation bar.
- 2) Click **Diagnostics > Trace** in the navigation tree. A list of all trace profiles appears, showing which trace profiles are started and which are not started.

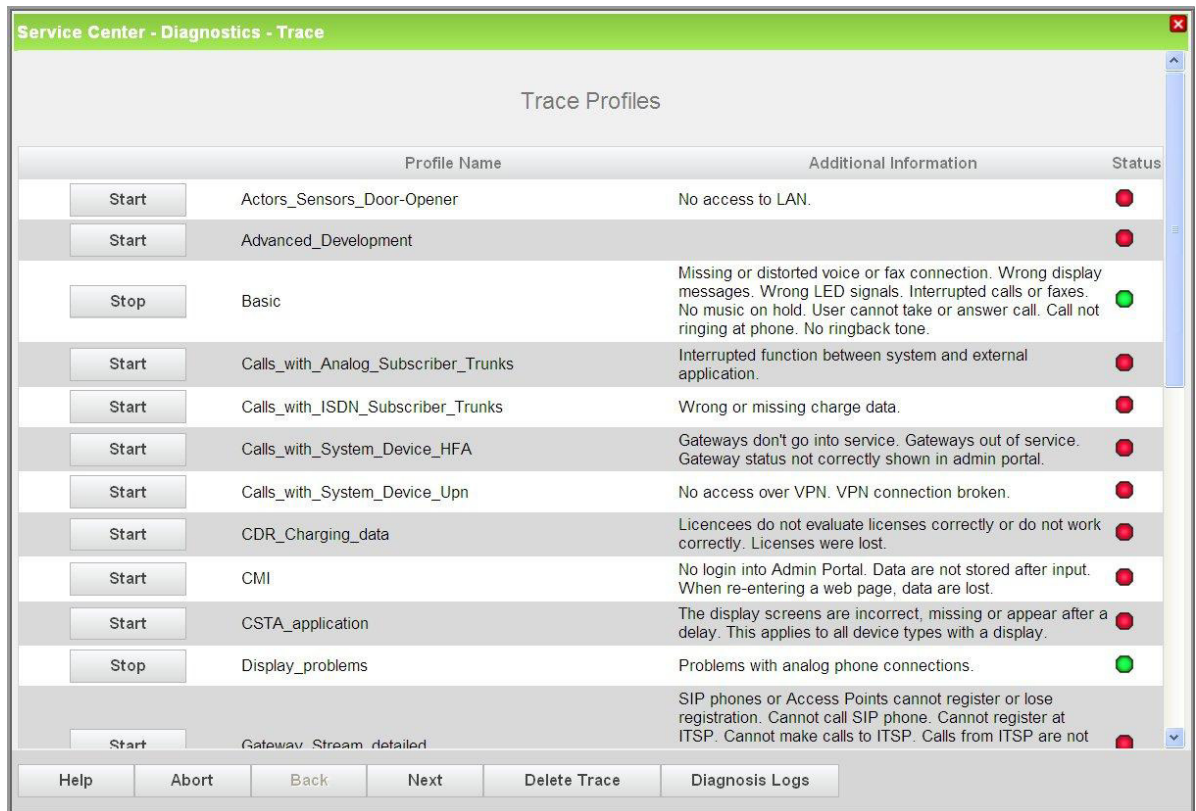

3) Click on **Next** followed by **Finish**.

#### 24.8.4.4 How to Start or Stop a Trace Profile

The **Trace** wizard can be used to start and stop trace profiles.

##### **Prerequisites**

- You are logged on to the WBM with the **Advanced** profile.

##### **Step by Step**

- Click on **Service Center** in the navigation bar.
- Click **Diagnostics > Trace** in the navigation tree. A list of all trace profiles appears. A red bullet point indicates the trace profiles that can be started. A green bullet point indicates the trace profiles that can be stopped.
- Select one of the following options:
  - If you want to start a trace profile, click **Start**. The color of the list item that shows the status of the associated trace profile changes from red to green.

**NOTICE:** Started trace profiles can have a negative impact on system performance. Consequently, after you finish your

## Maintenance

### Monitoring and Maintenance of OpenScape Business

diagnostic activities, make sure that you stop all trace profiles, except for the **Default** trace profile. The **Default** trace profile must remain active.

---

- If you want to stop a trace profile, click **Stop**. The color of the list item that shows the status of the associated trace profile changes from green to red.
- 4) Click on **Next** followed by **Finish**.

#### 24.8.4.5 How to Display or Edit the Trace Format Configuration

##### *Prerequisites*

- You are logged into the WBM with the **Expert** profile.
- A request to edit the trace format configuration has been submitted by the responsible Service Support.

##### *Step by Step*

- 1) In the navigation bar, click on **Expert Mode**.
- 2) Click **Maintenance > Traces** in the navigation tree.
- 3) Click on **Traces > Trace Format Configuration** in the menu tree. The current settings of the trace format configuration are displayed.
- 4) Change the desired settings if required.
- 5) Click on **Apply** followed by **OK**.

#### 24.8.4.6 How to Display or Edit the Trace Output Interfaces

##### *Prerequisites*

- You are logged into the WBM with the **Expert** profile.
- A request to edit the trace output interfaces has been submitted by the responsible Service Support.

##### *Step by Step*

- 1) In the navigation bar, click on **Expert Mode**.
- 2) Click **Maintenance > Traces** in the navigation tree.
- 3) Click on **Traces > Trace Output Interfaces** in the menu tree. The Simple Network Management Protocol (SNMP) is a network protocol which can be used to monitor and operate networking components (such as routers, servers, switches, printers, computers) from a central station (management console).
- 4) Change the desired settings if required.



- 5) Click on **Apply** followed by **OK**.

#### 24.8.4.7 How to Display or Edit Event Viewer and Customer Trace Logs

The **Event Viewer** wizard can be used to start the event display (customer trace) and to edit the Refresh settings.

##### *Prerequisites*

- You are logged on to the WBM with the **Advanced** profile.

##### *Step by Step*

- 1) Click on **Service Center** in the navigation bar.
- 2) Click **Diagnostics > Event Viewer** in the navigation tree.
- 3) Click on the **Display** tab.
- 4) Select the desired setting.
  - If you want the log to automatically refresh, select the **auto refresh** check box.
  - If you do not want the log to automatically refresh, clear the **auto refresh** check box.
- 5) If required, click **Refresh** to manually refresh the Customer Trace log.
- 6) Click on **Finish**.

#### 24.8.4.8 How to Download or Open the Event Viewer Log / Customer Trace Log

The **Event Viewer** wizard can be used to open the customer trace log file or to transfer it to a PC.

##### *Prerequisites*

- You are logged on to the WBM with the **Advanced** profile.

##### *Step by Step*

- 1) Click on **Service Center** in the navigation bar.
- 2) Click **Diagnostics > Event Viewer** in the navigation tree.
- 3) Click on the **Load via HTTP** tab.
- 4) Click on **Load** followed by **OK**. The File Download window appears.
- 5) Select one of the following options:
  - If you want to download the log file, click **Save As**. Save the file in the desired directory and then close the window that confirms the download of the file.

## Maintenance

Monitoring and Maintenance of OpenScape Business

- If you want to open the log file, click **Open**. The contents of the compressed log file is then displayed.
- 6) Click on **Finish**.

### 24.8.4.9 How to Clear the Event Viewer Log / Customer Trace Log

The **Event Viewer** wizard can be used to delete the customer trace log file.

#### *Prerequisites*

- You are logged on to the WBM with the **Advanced** profile.

#### *Step by Step*

- 1) Click on **Service Center** in the navigation bar.
- 2) Click **Diagnostics > Event Viewer** in the navigation tree.
- 3) Click on the **Clear Event Log** tab.
- 4) Click on **Delete Log** followed by **OK**.
- 5) Click on **Finish**.

### 24.8.4.10 How to Display M5T Trace Components

#### *Prerequisites*

- You are logged into the WBM with the **Expert** profile.

#### *Step by Step*

- 1) In the navigation bar, click on **Expert Mode**.
- 2) Click **Maintenance > Traces** in the navigation tree.
- 3) Click on **Traces > M5T Trace Components** in the menu tree. A list of all M5T trace components is displayed with the current settings. In addition, the names of all M5T trace components are displayed in the menu tree. The bullet point color indicates the status of each individual M5T trace component.

### 24.8.4.11 How to Start or Stop an M5T Trace Component

#### *Prerequisites*

- You are logged into the WBM with the **Expert** profile.
- A request to start or stop a M5T trace component has been submitted by the responsible Service Support.

### **Step by Step**

- 1) In the navigation bar, click on **Expert Mode**.
- 2) Click **Maintenance > Traces** in the navigation tree.
- 3) Click on **Traces > M5T Trace Components** in the menu tree. The names of all M5T trace components are displayed in the menu tree. A red bullet point indicates the M5T trace components that can be started. A green bullet point indicates the M5T trace components that can be stopped.
- 4) Click on the desired M5T trace component in the menu tree.
- 5) Click on the **Start/Stop Trace Component** tab.
- 6) Select one of the following options:
  - To start an M5T trace component, click **Start** and then **OK**.
  - To stop an M5T trace component, click **Stop** and then **OK**.

## **24.8.4.12 How to Edit M5T Trace Components**

### **Prerequisites**

- You are logged into the WBM with the **Expert** profile.
- A request to edit the M5T trace component has been submitted by the responsible Service Support.

### **Step by Step**

- 1) In the navigation bar, click on **Expert Mode**.
- 2) Click **Maintenance > Traces** in the navigation tree.
- 3) Click on **Traces > M5T Trace Components** in the menu tree. A list of all M5T trace components is displayed with the current settings.
- 4) Change the desired settings.
- 5) Click on **Apply** followed by **OK**.

## **24.8.4.13 How to Start or Stop the Secure Trace**

### **Prerequisites**

- You are logged into the WBM with the **Expert** profile.

### **Step by Step**

- 1) In the navigation bar, click on **Expert Mode**.
- 2) Click **Maintenance > Traces** in the navigation tree.
- 3) Click on **Traces > Secure Trace** in the menu tree.
- 4) Click on the **Start/Stop Secure Trace** tab.

## Maintenance

### Monitoring and Maintenance of OpenScape Business

- 5) Select one of the following options:
  - If you want to test the secure trace, proceed as follows:

Enter the password for the secure trace in the **Secure Trace Activation Passphrase** field.

Enter the time in minutes during which the secure trace is to be active in the **Duration of Secure Trace (Mins.)** field.

Enable the checkboxes of the protocols for which the secure trace should be created. Clear the checkboxes of the protocols for which the secure trace should not be created.

Click on **Start Secure Trace** followed by **OK**.
  - To stop the secure trace, click **Stop Secure Trace** followed by **OK**.

#### 24.8.4.14 How to Check the Secure Trace Status

##### *Prerequisites*

- You are logged into the WBM with the **Expert** profile.

##### *Step by Step*

- 1) In the navigation bar, click on **Expert Mode**.
- 2) Click **Maintenance > Traces** in the navigation tree.
- 3) Click on **Traces > Secure Trace** in the menu tree.
- 4) Click on the **Secure Trace State** tab. The current status of the secure trace is displayed.

#### 24.8.4.15 How to Change the Secure Trace Password

##### *Prerequisites*

- You are logged into the WBM with the **Expert** profile.

##### *Step by Step*

- 1) In the navigation bar, click on **Expert Mode**.
- 2) Click **Maintenance > Traces** in the navigation tree.
- 3) Click on **Traces > Secure Trace** in the menu tree.
- 4) Click on the **Change Secure Trace Passphrase** tab.
- 5) Enter the current password for the secure trace in the **Current Passphrase** field.
- 6) Enter the new password (5 characters min., 12 characters max.) for the secure trace in the **New Passphrase** and **Confirm New Passphrase** fields.
- 7) Click on **Apply**.

## 24.8.4.16 How to Import the Certificate for the Secure Trace from an X.509 File

### *Prerequisites*

- An X.509 file in PEM or binary format is available.
- You are logged into the WBM with the **Expert** profile.

### *Step by Step*

- 1) In the navigation bar, click on **Expert Mode**.
- 2) Click **Maintenance > Traces** in the navigation tree.
- 3) Click on **Traces > Secure Trace** in the menu tree.
- 4) Click on the **Import X.509 file for Secure Trace** tab.
- 5) Click on **Browse** to select the desired X.509 file.
- 6) Click on **Open**.
- 7) Click on **Import Certificate from File**.

## 24.8.4.17 How to Display or Edit the H.323 Stack Trace Configuration

### *Prerequisites*

- You are logged into the WBM with the **Expert** profile.
- A request to edit the H.323 stack trace configuration has been submitted by the responsible Service Support.

### *Step by Step*

- 1) In the navigation bar, click on **Expert Mode**.
- 2) Click **Maintenance > Traces** in the navigation tree.
- 3) Click on **Traces > H.323 Stack Trace** in the menu tree.
- 4) Click on the **Edit H.323 Stack Trace Configuration** tab. The current settings for the H.323 stack trace configuration are displayed.
- 5) Change the desired settings if required.
- 6) Click on **Apply** followed by **OK**.

## 24.8.4.18 How to Edit H.323 Modules

### *Prerequisites*

- You are logged into the WBM with the **Expert** profile.
- A request to edit the H.323 modules has been submitted by the responsible Service Support.

## Maintenance

Monitoring and Maintenance of OpenScape Business

### Step by Step

- 1) In the navigation bar, click on **Expert Mode**.
- 2) Click **Maintenance > Traces** in the navigation tree.
- 3) Click on **Traces > H.323 Stack Trace** in the menu tree.
- 4) Click on the **Edit All H.323 Modules** tab.
- 5) Select the desired setting for **Trace On**:
  - If you want to enable the trace for specific H.323 modules, select the check boxes for the desired H.323 modules. Disable the checkboxes of the H.323 modules for which the trace is to be deactivated.
  - If you want to disable the trace for all H.323 modules, click **None**.
- 6) Click on **Apply** followed by **OK**.

### 24.8.4.19 How to Download or Open the H.323 Stack Trace Log

#### Prerequisites

- You are logged into the WBM with the **Expert** profile.

#### Step by Step

- 1) In the navigation bar, click on **Expert Mode**.
- 2) Click **Maintenance > Traces** in the navigation tree.
- 3) Click on **Traces > H.323 Stack Trace** in the menu tree.
- 4) Click on the **Load H.323 Trace Log via HTTP** tab.
- 5) Click on **Load** followed by **OK**. The File Download window appears.
- 6) Select one of the following options:
  - If you want to save the H.323 stack trace log file, click **Save As**. Save the file in the desired directory and then close the window that confirms the download of the file.
  - To open the H.323 stack trace log file, click **Open**. The file is then displayed in the text editor.

### 24.8.4.20 How to Clear the H.323 Trace Log

#### Prerequisites

- You are logged into the WBM with the **Expert** profile.

#### Step by Step

- 1) In the navigation bar, click on **Expert Mode**.
- 2) Click **Maintenance > Traces** in the navigation tree.

- 3) Click on **Traces > H.323 Stack Trace** in the menu tree.
- 4) Click on the **Clear H.323 Trace Log** tab.
- 5) Click on **Delete Log** followed by **OK**.

#### 24.8.4.21 How to Edit the License Component Trace

##### *Prerequisites*

- You are logged into the WBM with the **Expert** profile.
- A request to edit the license component trace has been submitted by the responsible Service Support.

##### *Step by Step*

- 1) In the navigation bar, click on **Expert Mode**.
- 2) Click **Maintenance > Traces** in the navigation tree.
- 3) Click on **Traces > License Component > CLA** in the menu tree.
- 4) Select one of the following options:
  - If you want to stop the license component trace, select the item **Off** in the **Trace Level** drop-down list.
  - If you want a low level of detail for the trace recording, select the item **Low** in the **Trace Level** drop-down list.
  - If you want a medium level of detail for the trace recording, select the item **Standard** in the **Trace Level** drop-down list.
  - If you want a high level of detail for the trace recording, select the item **All** in the **Trace Level** drop-down list.
- 5) Click on **Apply**.

#### 24.8.4.22 How to Display Details of a Trace Profile

##### *Prerequisites*

- You are logged into the WBM with the **Expert** profile.

##### *Step by Step*

- 1) In the navigation bar, click on **Expert Mode**.
- 2) Click **Maintenance > Traces** in the navigation tree.
- 3) Click on **Traces > Trace Profiles** in the menu tree. A list of all trace profiles appears. In addition, the names of all trace profiles are displayed in the menu tree. The bullet point color indicates the status of each individual trace profile.
- 4) Click the name of the desired trace profile in the menu tree. Details about this trace profile are displayed.

## Maintenance

Monitoring and Maintenance of OpenScape Business

### 24.8.4.23 How to Stop all Trace Profiles

#### *Prerequisites*

- You are logged into the WBM with the **Expert** profile.

#### *Step by Step*

- 1) In the navigation bar, click on **Expert Mode**.
- 2) Click **Maintenance > Traces** in the navigation tree.
- 3) Click on **Traces > Trace Profiles** in the menu tree.
- 4) Click on the **Stop All Trace Profiles** tab.
- 5) Click on **Stop All** followed by **OK**.

### 24.8.4.24 How to Add a Trace Profile

#### *Prerequisites*

- You are logged into the WBM with the **Expert** profile.

#### *Step by Step*

- 1) In the navigation bar, click on **Expert Mode**.
- 2) Click **Maintenance > Traces** in the navigation tree.
- 3) Click on **Traces > Trace Profiles** in the menu tree.
- 4) Select one of the following options:
  - If you want to add a blank trace profile, click the **Add Trace Profile (Empty Profile)** tab.
  - If you want to add a trace profile containing the trace components of all trace profiles currently started, click the **Add Trace Profile (with Current Trace Settings)** tab. Select which of the displayed trace components (and with which trace level) should be included in the new trace profile.
- 5) Enter the name of the new trace profile in the **Profile Name** field.
- 6) Click on **Apply** followed by **OK**.

### 24.8.4.25 How to Display Trace Components

#### *Prerequisites*

- You are logged into the WBM with the **Expert** profile.



### **Step by Step**

- 1) In the navigation bar, click on **Expert Mode**.
- 2) Click **Maintenance > Traces** in the navigation tree.
- 3) Click on **Traces > Trace Components** in the menu tree.
- 4) Select one of the following options:
  - If you want to display the list of all trace components, click the **Display All Trace Components** tab.
  - If you want to display the list of all started trace components, click the **Display Started Trace Components** tab.
  - If you want to display the list of all stopped trace components, click the **Display Stopped Trace Components** tab.

## **24.8.4.26 How to Display Details of a Trace Component**

### **Prerequisites**

- You are logged into the WBM with the **Expert** profile.

### **Step by Step**

- 1) In the navigation bar, click on **Expert Mode**.
- 2) Click **Maintenance > Traces** in the navigation tree.
- 3) Click on **Traces > Trace Components** in the menu tree. A list of all trace components appears. In addition, the names of all trace components are displayed in the menu tree. The bullet point color indicates the status of each individual trace component.
- 4) Click on the name of the desired trace component in the menu tree. Details about this trace component are displayed.

## **24.8.4.27 How to Start or Stop a Trace Component**

### **Prerequisites**

- You are logged into the WBM with the **Expert** profile.

### **Step by Step**

- 1) In the navigation bar, click on **Expert Mode**.
- 2) Click **Maintenance > Traces** in the navigation tree.
- 3) Click on **Traces > Trace Components** in the menu tree. The names of all trace components are displayed in the menu tree. A red bullet point indicates the trace components that can be started. A green bullet point indicates the trace components that can be stopped.

## Maintenance

Monitoring and Maintenance of OpenScape Business

- 4) Click on the desired trace component in the menu tree.
- 5) Click on the **Start/Stop Trace Component** tab.
- 6) Select one of the following options:
  - To start a trace component, click **Start** and then **OK**.
  - To stop a trace component, click **Stop** and then **OK**.

### 24.8.4.28 How to Stop all Trace Components

#### *Prerequisites*

- You are logged into the WBM with the **Expert** profile.

#### *Step by Step*

- 1) In the navigation bar, click on **Expert Mode**.
- 2) Click **Maintenance > Traces** in the navigation tree.
- 3) Click on **Traces > Trace Components** in the menu tree.
- 4) Click on the **Stop All Trace Components** tab.
- 5) Click on **Stop All** followed by **OK**.

### 24.8.4.29 How to Edit Trace Components

#### *Prerequisites*

- You are logged into the WBM with the **Expert** profile.

#### *Step by Step*

- 1) In the navigation bar, click on **Expert Mode**.
- 2) Click **Maintenance > Traces** in the navigation tree.
- 3) Click on **Traces > Trace Components** in the menu tree.
- 4) Click on the **Edit Trace Components** tab. A list of all trace components is displayed with the current settings.
- 5) Change the desired settings.
- 6) Click on **Apply** followed by **OK**.

## 24.8.5 TCP Dump

A TCP dump is used for monitoring and evaluating data traffic in an IP network.

---

**INFO:** Activating a TCP dump can have a negative impact on system performance and must hence only be performed by experienced administrators and only after consulting with the responsible Service Support.

---

TCP dump files are stored in the communication system. An appropriate application is required for the diagnosis of the files.

TCP dumps are often used to

- generate a LAN trace for a short period of time (e.g., for a reproducible error image).
- allow authorized service technicians to remotely access a LAN trace.

Advantages over RPCAP daemon: remote access is possible, so trace files do not have to be sent by e-mail

Disadvantages compared to RPCAP daemon: long-term traces are not meaningful; limited storage space, no capture filter can be set, more complex handling for several individual traces

### 24.8.5.1 How to Start a TCP Dump

#### *Prerequisites*

- You are logged into the WBM with the **Expert** profile.

#### *Step by Step*

- 1) In the navigation bar, click on **Expert Mode**.
- 2) In the navigation tree, click on **Traces > TCP Dump**.
- 3) Click on **Start TCP Dump**.
- 4) Select the desired settings.
- 5) Click on **Apply** followed by **OK**.

### 24.8.5.2 How to Stop a TCP Dump

#### *Prerequisites*

- You are logged into the WBM with the **Expert** profile.

#### *Step by Step*

- 1) In the navigation bar, click on **Expert Mode**.
- 2) In the navigation tree, click on **Traces > TCP Dump**.
- 3) Click on **Stop TCP Dump**.
- 4) Click on **OK**.

## Maintenance

Monitoring and Maintenance of OpenScape Business

### 24.8.5.3 How to Delete a TCP Dump

#### *Prerequisites*

- You are logged into the WBM with the **Expert** profile.

#### *Step by Step*

- 1) In the navigation bar, click on **Expert Mode**.
- 2) In the navigation tree, click on **Traces > TCP Dump**.
- 3) Click on **Cleanup TCP Dump**.
- 4) Click on **Apply**, followed by **OK**.

### 24.8.6 RPCAP daemon

An RPCAP (Remote Packet Capture) daemon is used for monitoring and evaluating data traffic in an IP network.

---

**INFO:** Activating an RPCAP daemon can have a negative impact on system performance and must hence only be performed by experienced administrators and only after consulting with the responsible Service Support.

---

The RPCAP daemon enables external applications to remotely access the TCP/IP packets on the LAN interfaces of the communication system.

An RPCAP a daemon is often used for long-term traces, since the trace files are stored on a PC and not in the communication system.

Advantages over TCP dump: faster and easier to use, long-term traces possible, number and/or size of the trace files can be freely selected, trace of internal LAN possible

Disadvantages compared to TCP dump: double network traffic and therefore increased load on the LAN interfaces of the communication system, special opening of ports needed (firewall)

#### 24.8.6.1 How to Enable the RPCAP Daemon

#### *Prerequisites*

- You are logged into the WBM with the **Expert** profile.
- The RPCAP daemon was disabled.

### ***Step by Step***

- 1) In the navigation bar, click on **Expert Mode**.
- 2) In the navigation tree, click on **Traces > rpcap Daemon**.
- 3) Select the desired settings.
- 4) Click on **Apply** followed by **OK**.

## **24.8.6.2 How to Disable the RPCAP Daemon**

### ***Prerequisites***

- You are logged into the WBM with the **Expert** profile.
- The rpcap daemon was enabled.

### ***Step by Step***

- 1) In the navigation bar, click on **Expert Mode**.
- 2) In the navigation tree, click on **Traces > rpcap Daemon**.
- 3) Click on **Apply** followed by **OK**.

## **24.8.7 Events**

Events provide information about communication system deficiencies. All events are written to a log file that is restricted in size. A new file is created if the maximum file size is exceeded. Up to seven files can be created.

Depending on the setting in the reaction table and the problem class, events may generate an SNMP trap, trigger an e-mail and/or start or stop trace monitoring. The event log (Event Viewer) can be evaluated, configured, and saved via the WBM.

## Maintenance

### Monitoring and Maintenance of OpenScape Business

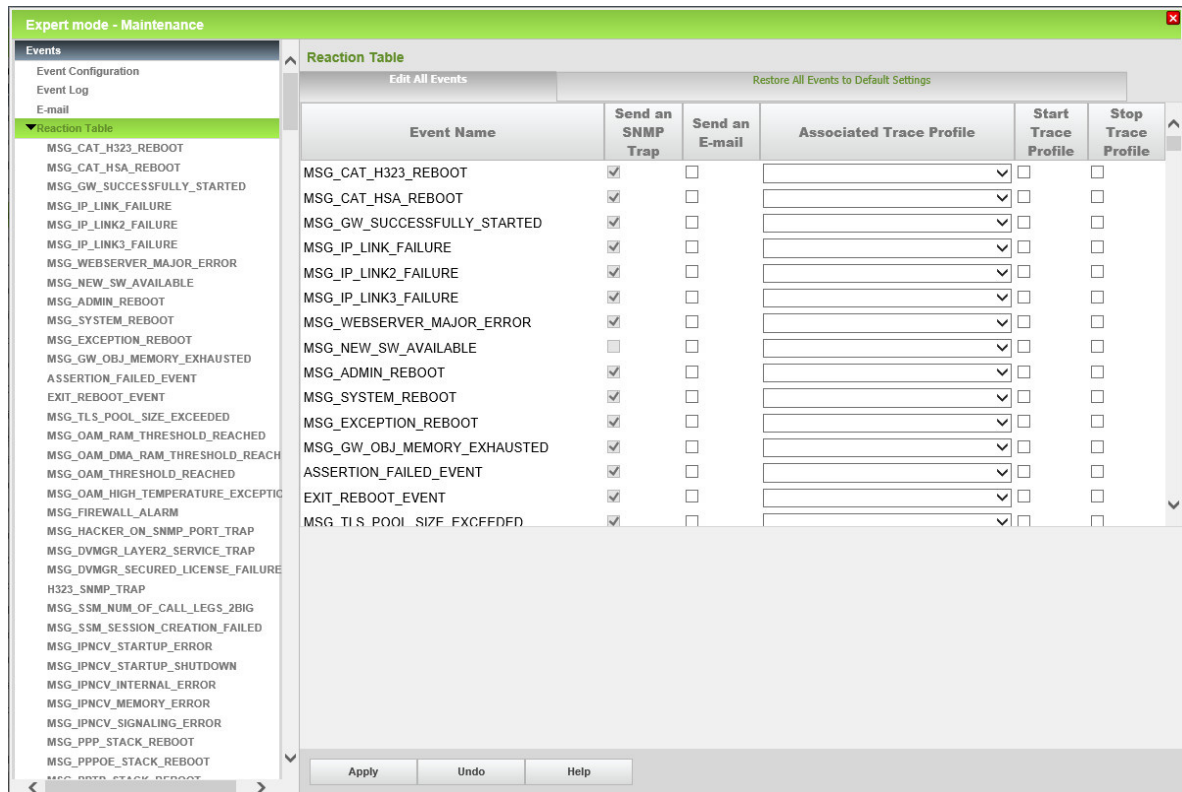

To interpret the event log file, you must download and extract the file with the WBM. The file can then be opened, edited and printed using any text editor. Once the event log file has been transferred, the file can be deleted from the communication system's memory.

Events that can trigger actions are defined by the following properties:

- Event code:  
Identifies an event such as `MSG_ADMIN_LOGGED_OUT` = Logout information of an administrator.
- Event type:  
The following different types exist:
  - Information: plain status messages, no error messages.
  - Warning: report of a possibly problematic procedure or status, but not an error message.
  - Minor: error message. The error has no problematic consequences.
  - Major: error message. This error could cause problems.
  - Critical: Error Message. This error causes problems.
  - Cleared: error message. The error was already corrected by the communication system.
  - Indeterminate: error message. The cause of the error cannot be accurately determined.
- Event text  
Some event texts contain variable data. These are identified in the following manner:

- %s: character string
- %u: positive or negative decimal number
- %f: floating point number
- %p: indicator (memory address)
- %x: hexadecimal number (with lower-case letters)
- %X: hexadecimal number (with upper-case letters)
- %C: single character
- %d and %l: positive decimal number

### **Reaction Table**

For each possible event, the Reaction Table can be used by an administrator with the **Expert** profile to independently define what action is to be taken when that event occurs.

You can set whether an SNMP trap should be sent, whether the communication system should be restarted, whether the e-mail should be sent, and whether a trace profile should be started or stopped. If the event is assigned a trace profile, the name of this profile is shown.

### **E-mail Settings**

These settings can be made by an administrator with the **Expert** profile to define how e-mails are sent when an event occurs.

### **Diagnosis Logs**

The communication system logs certain process-specific actions in diagnosis logs. These log files can be evaluated for diagnostic purposes by an administrator with the **Expert** profile.

### **Alarm Signaling on Exceeding Critical Temperatures**

Two critical temperature values are stored in the communication system. If the temperature of the system exceeds the first value, a warning is sent via an SNMP trap or e-mail to indicate that the system temperature is too high. In addition, this message can also be indicated on the displays of up to three system telephones (UP0 & HFA). If the second value is exceeded, the boards responsible for the overheating are shut down in a controlled manner (e.g., OpenScape Business Booster Card) or switched off (e.g., SLAV/SLAD). To clear the alarm and put the boards back into service, the system must be switched off and then switched on again.

The 3 destinations (system telephones) to be notified at on exceeding a temperature can be set.

## **24.8.7.1 How to Edit Switch Event Logging via a LAN**

### ***Prerequisites***

- You are logged into the WBM with the **Expert** profile.

## Maintenance

Monitoring and Maintenance of OpenScape Business

### *Step by Step*

- 1) In the navigation bar, click on **Expert Mode**.
- 2) Click on **Maintenance > Events** in the navigation tree.
- 3) Click on **Events > Event Configuration** in the menu tree.
- 4) Select the desired setting.
  - If you want event logging to be transferred via LAN, select the check box **Switch Event Logging via LAN On**.
  - If you do not want event logging to be transferred via LAN, clear the check box **Switch Event Logging via LAN On**.
- 5) Click on **Apply** followed by **OK**.

### 24.8.7.2 How to Download the Event Log File

#### *Prerequisites*

- You are logged into the WBM with the **Expert** profile.

#### *Step by Step*

- 1) In the navigation bar, click on **Expert Mode**.
- 2) Click on **Maintenance > Events** in the navigation tree.
- 3) Click on **Events > Event Log** in the menu tree.
- 4) Click on the **Load via HTTP** tab.
- 5) Click on **Load** followed by **OK**. The File Download window appears.
- 6) Save the file in the desired directory. Then close the window that confirms the download of the file.

### 24.8.7.3 How to Delete an Event Log File

#### *Prerequisites*

- You are logged into the WBM with the **Expert** profile.

#### *Step by Step*

- 1) In the navigation bar, click on **Expert Mode**.
- 2) Click on **Maintenance > Events** in the navigation tree.
- 3) Click on **Events > Event Log** in the menu tree.
- 4) Click on the **Clear Event Log** tab.
- 5) Click on **Delete Log** followed by **OK**.



### 24.8.7.4 How to Edit E-Mail Settings for Events

#### *Prerequisites*

- You are logged into the WBM with the **Expert** profile.

#### *Step by Step*

- 1) In the navigation bar, click on **Expert Mode**.
- 2) Click on **Maintenance > Events** in the navigation tree.
- 3) Click on **Events > E-mail** in the menu tree.
- 4) Under **Subject**, enter what you want displayed as the Subject field of the e-mail.

---

**INFO:** The subject should state clearly that the e-mail concerns an event.

---

- 5) Enter the e-mail addresses to which the e-mail should be sent in the fields **Recipient 1** through **Recipient 5**.
- 6) Click on **Apply** followed by **OK**.

### 24.8.7.5 How to Display the Event Reaction Table

#### *Prerequisites*

- You are logged into the WBM with the **Expert** profile.

#### *Step by Step*

- 1) In the navigation bar, click on **Expert Mode**.
- 2) Click on **Maintenance > Events** in the navigation tree.
- 3) Click on **Events > Reaction Table** in the menu tree. The reaction table is displayed with all possible events and their settings.

### 24.8.7.6 How to Edit the Reaction Settings for an Event

#### *Prerequisites*

- You are logged into the WBM with the **Expert** profile.

#### *Step by Step*

- 1) In the navigation bar, click on **Expert Mode**.
- 2) Click on **Maintenance > Events** in the navigation tree.

## Maintenance

### Monitoring and Maintenance of OpenScape Business

- 3) Click on **Events > Reaction Table** in the menu tree. The reaction table is displayed with all possible events and their settings. In addition, the names of all possible events are displayed in the menu tree.
- 4) Click on the name of the desired event in the menu tree.
- 5) Click on the **Edit Event** tab. Details on the reaction settings for the desired event are displayed.

---

**INFO:** The reaction settings **Reset Gateway** and **Notify OpenScape** cannot be edited. It is not possible to change the **Send an SNMP Trap** setting for all events.

---

- 6) If possible, select the setting for **Send an SNMP Trap**:
  - If you want an SNMP trap to be sent when the event occurs, enable the check box **Send an SNMP Trap**.
  - If you do not want an SNMP trap to be sent when the event occurs, disable the **Send an SNMP Trap** check box.
- 7) Select the setting to **send an e-mail**:
  - If you want an e-mail to be sent when the event occurs, enable the check box **Send an E-mail**.
  - If you do not want an e-mail to be sent when the event occurs, disable the **Send an E-mail** check box.
- 8) Select the desired trace profile in the **Associated Trace Profile** drop-down list.
- 9) Select the setting to start or stop the trace profile:
  - If the selected trace profile is to be started when the event occurs, enable the check box **Start Trace Profile**.
  - If the selected trace profile is to be stopped when the event occurs, enable the check box **Stop Trace Profile**.
- 10) Click on **Apply** followed by **OK**.

#### 24.8.7.7 How to Edit the Reaction Settings for Multiple Events

##### *Prerequisites*

- You are logged into the WBM with the **Expert** profile.

##### *Step by Step*

- 1) In the navigation bar, click on **Expert Mode**.
- 2) Click on **Maintenance > Events** in the navigation tree.
- 3) Click on **Events > Reaction Table** in the menu tree. The reaction table is displayed with all possible events and their reaction settings.

---

**INFO:** The reaction settings **Reset Gateway** and **Notify OpenScape** cannot be edited. It is not possible to change the **Send an SNMP Trap** setting for all events.

---

- 4) Change the reaction settings for the events you want in the reaction table:
  - If possible, select the setting for **Send an SNMP Trap**:  
If you want an SNMP trap to be sent when the event occurs, enable the check box **Send an SNMP Trap**.  
If you do not want an SNMP trap to be sent when the event occurs, disable the **Send an SNMP Trap** check box.
  - Select the setting to **send an e-mail**:  
If you want an e-mail to be sent when the event occurs, enable the check box **Send an E-mail**.  
If you do not want an e-mail to be sent when the event occurs, disable the **Send an E-mail** check box.
  - Select the desired trace profile in the **Associated Trace Profile** drop-down list.
  - Select the setting to start or stop the trace profile:  
If the selected trace profile is to be stopped when the event occurs, enable the check box **Start Trace Profile**.  
If the selected trace profile is to be started when the event occurs, enable the check box **Stop Trace Profile**.
- 5) Click on **Apply** followed by **OK**.

### 24.8.7.8 How to Download or Open Diagnosis Logs

#### *Prerequisites*

- You are logged into the WBM with the **Expert** profile.

#### *Step by Step*

- 1) In the navigation bar, click on **Expert Mode**.
- 2) Click on **Maintenance > Events** in the navigation tree.
- 3) Click on **Events > Diagnosis Logs** in the menu tree.
- 4) Click on the **Get Diagnosis Logs** tab. You will see a list of all available logs with the respective file name, file size in bytes, time of last activation and file attributes.
- 5) Click under **File Name** of the name of diagnosis log you want. The File Download window appears.
- 6) Save the file in the desired directory. Then close the window that confirms the download of the file.

## Maintenance

Monitoring and Maintenance of OpenScape Business

### 24.8.7.9 How to Clear Diagnosis Logs

#### *Prerequisites*

- You are logged into the WBM with the **Expert** profile.

#### *Step by Step*

- 1) In the navigation bar, click on **Expert Mode**.
- 2) Click on **Maintenance > Events** in the navigation tree.
- 3) Click on **Events > Diagnosis Logs** in the menu tree. You will see a list of all available logs with the respective file name, file size in bytes, time of last activation and file attributes.
- 4) Click on the **Delete Diagnosis Logs** tab.
- 5) Click on **Delete Log** followed by **OK**.

### 24.8.7.10 How to Define Destinations for Alarm Signaling

#### *Prerequisites*

- You are logged into the WBM with the **Expert** profile.

#### *Step by Step*

- 1) In the navigation bar, click on **Expert Mode**.
- 2) Click on **Maintenance > Events** in the navigation tree.
- 3) Click on **Events > Alarm Signaling** in the menu tree.
- 4) In the **Stations 1-3** drop-down lists, select the three destinations (system telephones with display, UP0 & HFA) where a notification is to be displayed when the system temperature exceeds a preset critical value.
- 5) Click on **Apply**, followed by **OK**.

## 24.8.8 Configuration Data for Diagnostics

"Smaller" backup sets containing diagnostic data for Service Support can be created for diagnostic purposes. In contrast to normal backup sets, significantly smaller data amounts are produced for this purpose and can thus be easily sent with an e-mail, for example.

Diagnostics backup sets include, among other things, the configuration data of the communication system and the UC Application (UC Smart or UC Suite). Voicemails, fax messages and announcements are not included.

The following media can be used to save backup sets for diagnostics:

- **USB Device**

The data can be backed up to a connected USB drive or a connected USB stick, for example.

---

**NOTICE:** If a USB hard disk, a partition thereof, or a USB stick is to be used for the backup, it must be formatted with FAT 32. USB media formatted with NTFS are read-only. Note that if multiple partitions exist, only the first partition can be used for the backup. If a bootable USB device is used for the backup, this USB device must be safely removed after the backup.

---

- **HTTPS**

The data can be saved via HTTPS on the hard disk of the client PC.

- **Hard Disk** (only for OpenScape UC X3/X5/X8 UC Booster Card (OCAB Application Board))

The data can be saved on the hard disk of the OCAB Application Board.

---

**INFO:** It is not possible to create a backup on the hard disk of the communication system.

---

## 24.8.8.1 How to Generate Configuration Data for Diagnostics

### Prerequisites

- You are logged on to the WBM with the **Advanced** profile.

### Step by Step

- 1) Click on **Backup and Restore** in the navigation bar.
- 2) In the navigation tree, click **Data Backup > Backup - Immediate**.

Device	Server address	Path	Login name	Max. backup sets
<input type="radio"/> Hard disk	-	/mnt/persistent/backup	-	5
<input checked="" type="radio"/> HTTPS	-	-	-	-

## Maintenance

### Monitoring and Maintenance of OpenScape Business

- 3) Enable the **Diagnostics** check box.
- 4) Select the device on which the diagnostics backup set is to be saved You have the following options:
  - If you want to save the data on a connected USB drive or a connected USB stick, enable the **USB Device** radio button.
  - If you want to back up the data using HTTPS on the hard disk of the client PC, enable the **HTTPS** radio button.
  - Only for OpenScape Business X3/X5/X8 with UC Booster Card (Application Board OCAB): If you want to save the data on the hard disk of the Application Board OCAB, select the **Hard Disk** radio button.
- 5) If required, enter a comment for your diagnostics backup set in the **Comment** field. Avoid the use of diacritical characters such as umlauts and special characters in your input.
- 6) Click on **OK & Next**. The progress of the backup process is displayed in a separate window.
- 7) The backup was successful if the message `Backup complete!` appears.
- 8) If you have selected **HTTPS** as a backup medium, you must save the diagnostics backup set and the associated text file with to a location of your choice. This is done automatically for the other backup media. The browser window must remain open until the save operation for the diagnostics backup set and text file has been completed.

---

**NOTICE:** If you selected **USB Device** as a backup medium, wait till the LED of the USB device stops flashing. It is only then that the diagnostics backup set has been completely stored on the USB device. You can then remove the USB device.

---

- 9) Click on **Finish**.

#### **Next steps**

The diagnostics backup set can now be sent to the responsible Service Support by e-mail to assist in the troubleshooting process, for example.

## 24.8.9 Card Manager

The Card Manager is a tool with which the software of the communication system can be written to an SDHC card. To do this, the software of the communication system must be available as an image file.

The software on the SDHC card is standard system software without customer data. SDHC cards cannot be used for software updates or for backing up customer data.

The Card Manager can be launched either as a Java application on a Linux PC (also possible in a virtual environment) or by using a Linux boot DVD.

### Use Cases

- Before the delivery of the system, the software should be replaced with the latest software version.
- The used SDHC card is defective and must be replaced by a new SDHC card on which no software has yet been stored.
- The used software is corrupted and needs to be reloaded. All customer data is deleted in the process.  
If a backup set exists for the recovery of the customer data, the newly installed software should match the software version with which the backup set was created so that the settings contained in the backup set can also be supported and processed by the installed software.

### Hardware and Software Prerequisites

The following hardware and software are required:

- External USB SDHC card reader. PC-internal SDHC card readers are not supported.
- For an SDHC card replacement: shared SDHC card.
- Image tar file with the latest communication software
- Card Manager File:
  - Alternative 1 - Card Manager jar file: this Java application can be launched directly from a Linux PC or from a Linux PC in a virtual environment.
  - Alternative 2 - Card Manager iso file: this file can be used to burn a Linux boot DVD that starts the Card Manager automatically after booting the Linux system.

## 24.8.9.1 How to Use the Card Manager to Write the Communication Software on the SDHC Card

### *Prerequisites*

- A current image file is available as a tar file. The shared SDHC card and a corresponding USB SDHC card reader are available.
- The write protection of the SDHC card is disabled.
- Card Manager on Linux boot DVD: the current Card Manager iso file and an admin PC with a Windows operating system are available.
- Card Manager through Java application: the current Card Manager jar file and a Linux PC are available.
- The communication system is powered off, and the SDHC card has been removed.

**Step by Step**

- 1) If you want to start the Card Manager using a Linux boot DVD:
  - a) Store the current image tar file and the current Card Manager iso file on the admin PC.
  - b) Create a Linux boot DVD on the admin PC from the current Card Manager iso file.
  - c) Insert the card reader into a USB port. The SDHC card must not be inserted!
  - d) Insert the Linux Boot DVD into the DVD drive and boot up the admin PC from the DVD. The Linux operating system is loaded, and the Card Manager is started automatically.
- 2) If you want to start the Card Manager through the Java application:
  - a) Store the current image tar file and the current Card Manager jar file on the desktop of the Linux PC.
  - b) Right-click on the desktop and open a new terminal window.
  - c) Start the Card Manager by typing the following command in the terminal:

```
java -jar ./<path_to_desktop>/  
<CardManagerFileName>.jar
```
- 3) In the Card Manager, select **OCC** from the drop-down list to write to the SDHC card.
- 4) Click on **Find**. The following message appears:

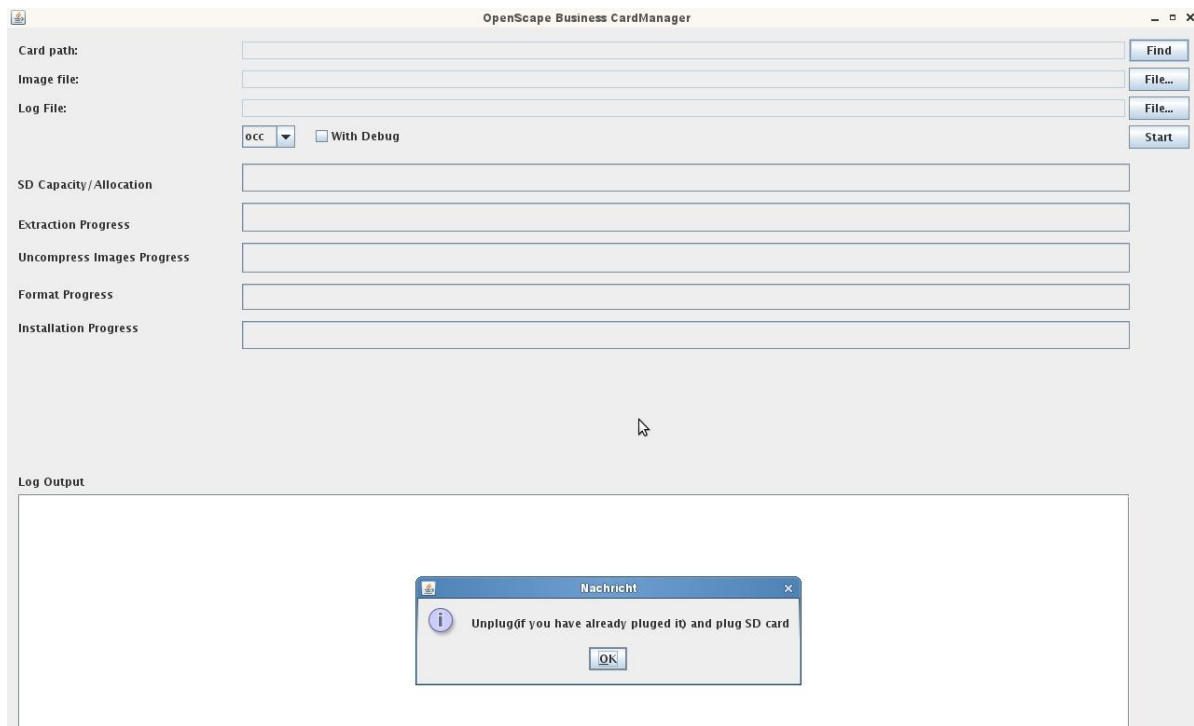



- 5) Insert the SDHC card into the card reader and confirm the message with **OK**. The path to the SDHC card appears under **Card path**.
- 6) Click under **Image file** on **File ...** and select the image tar file located on the desktop. The path to the image tar file appears under **Image file**.
- 7) Optionally, you can also create a log file that records any program errors that may have occurred. To do this, click under **Log File** on **File ...** and navigate to the storage location of the log file. Enter a name for the log file and confirm it with **Save**. The path to the log file is displayed under **Log File**.
- 8) Click on **Start**. The write process is started. The progress of each step is shown via a progress bar. After the writing process has completed successfully, the message **SD Card initialization what SUCCESSFUL** appears.

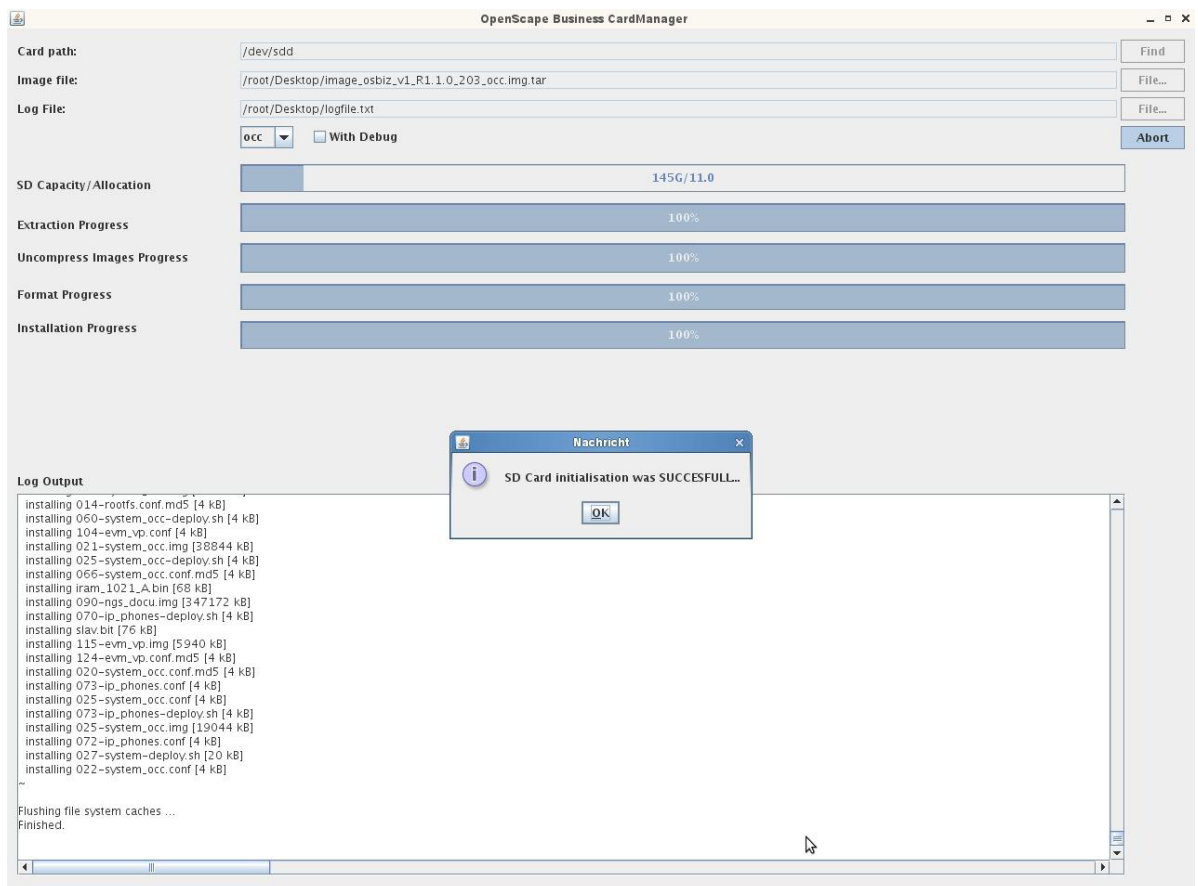

- 9) Confirm the message **OK** and remove the SDHC card from the card reader.
- 10) Close the Card Manager via the X symbol at the top right edge of the window.
- 11) Only for Card Manager when using a Linux boot DVD: briefly press the ON/OFF button on the admin PC, confirm the message with **Yes**, and, when prompted, remove the DVD from the DVD drive.
- 12) Remove the card reader from the USB port.
- 13) Insert the SDHC card into the SD slot of the switched off communication system.

## Maintenance

### Monitoring and Maintaining the UC Suite

- 14) Turn on the communication system. The system is ready for operation when the green LED flashes at 1Hz (0.5 sec on / 0.5 sec off).

---

**INFO:** The system starts up with the default values, including, among other things, the default IP address 192.168.1.2.

---

- 15) Perform the initial installation using the WBM (<https://192.168.1.2>) or restore the system settings and customer data through a backup set (if available).

## 24.9 Monitoring and Maintaining the UC Suite

The WBM **Expert** profile offers administrators numerous functions for monitoring and maintaining the UC Suite.

### 24.9.1 Logging

The execution of the UC Suite is monitored internally by the system. **System Logging** can be used to set whether logs should be created. In addition, a log of the activities of the UC Suite (e.g., the start of a UC Suite client) is maintained in **Client Logs**.

The screenshot shows a web-based configuration interface for 'System Logging'. On the left, a navigation menu lists 'General Settings', 'Live Record', 'Logging' (highlighted), 'Notifications', 'Maintainance', and 'VoiceMail'. The main content area is titled 'System Logging' and includes the following options:

- Log Trace Messages (Verbose)**:
- Client Logs**
  - Client Log Path:**
  - Enable log upload**:
  - Enable client logging**:

At the bottom of the configuration area are two buttons: 'Save' and 'Reset'.

#### System Logging

The following system logs can be enabled or disabled:

System log	Default setting
Log Trace Messages (Verbose)	Not activated

The results of the enabled system log are written daily to a log file with the designation `vs-yyyy-mm-dd.log` (e.g., `vs-2013-01-222.log`) and stored in the communication system under `/var/system/trace_log/vsl/log`.

---

**INFO:** The analysis of these log files can only be performed by Development.

---

### Client Logs

**Client Logs** are the log files of the UC Suite. For each UC Suite client (myPortal for Desktop, myAttendant, etc.) and station (user), a separate directory is created, and the relevant log files are stored in it. The logs record the activities of a subscriber such as starting the client, outgoing and incoming calls, etc.

---

**INFO:** The storage of client logs is supported only for the UC Suite clients used with Microsoft Windows operating systems.

---

The path in which the `CC-Logs` directory with the subdirectories for the individual UC Suite clients is to be stored can be defined. You can also select whether the directory is to be stored on every client PC or on a central PC or server on the network.

By default, the `CC-Logs` directory is stored in the following path:

`<Drive>:\Documents and Settings/<PC User Name>/CC-Logs`

The retention period for **Client Logs** is 5 days. No changes are possible.

The logging of the UC Suite activities in **Client Logs** is enabled by default. Administrators with the **Advanced** profile can disable logging on a station-specific basis by using the **User Directory** wizard. An administrator with the **Expert** profile can disable logging on a station-specific basis in **Expert Mode**.

Depending on the scenario, the client logs are also stored by default on the hard disk of the UC Booster Card (OCAB), the UC Booster Server or the OpenScape Business S communication system. An administrator with the **Expert** profile can disable the saving of client logs on the system hard disk in **Expert Mode**.

An administrator with the **Advanced** profile can use the **Trace** wizard to download the client logs (log files) of the UC Suite clients (myPortal for Desktop, myAttendant, etc.) used by the internal subscribers.

An administrator with the **Expert** profile can use the **Expert mode** wizard to download the client logs (log files) of the UC Suite clients (myPortal for Desktop, myAttendant, etc.) used by the internal subscribers.

## 24.9.1.1 How to Enable or Disable Recording of System Logs

### *Prerequisites*

- You are logged into the WBM with the **Expert** profile.

## Maintenance

### Monitoring and Maintaining the UC Suite

#### *Step by Step*

- 1) In the navigation bar, click on **Expert Mode**.
- 2) In the navigation tree, click on **Applications > OpenScape Business UC Suite**.
- 3) Click on **Server**, followed by **Logging**.
- 4) Select one of the following options:
  - If trace messages are to be recorded daily in a log file, select the **Log Trace Messages (Verbose)** check box.
  - If you do not want trace messages to be recorded in a log file, clear the **Log Trace Messages (Verbose)** check box).
- 5) Click on **Save**.

#### 24.9.1.2 How to Enable or Disable the Recording of Client Logs on a System-wide Basis

##### *Prerequisites*

- You are logged into the WBM with the **Expert** profile.

##### *Step by Step*

- 1) In the navigation bar, click on **Expert Mode**.
- 2) In the navigation tree, click on **Applications > OpenScape Business UC Suite**.
- 3) Click on **Server**, followed by **Logging**.
- 4) Select one of the following options:
  - If client logs are to be recorded, select the **Enable Client Logging** check box.
  - If you do not want client logs are to be recorded, clear the **Enable Client Logging** check box.

---

**INFO:** The recording of client logs is supported only for the UC Suite clients used with Microsoft Windows operating systems.

---

- 5) Click on **Save**.

#### 24.9.1.3 How to Enable or Disable the Recording of Client Logs on a Station-specific Basis

##### *Prerequisites*

- You are logged on to the WBM with the **Advanced** profile.

### **Step by Step**

- 1) In the navigation bar, click on **Setup**.
- 2) Click in the navigation tree on **Wizards > UC Suite**.
- 3) Click on **Edit** to start the **User Directory** wizard.
- 4) Mark the desired station in the user directory and click **Edit**.
- 5) Click on **My Preferences > Miscellaneous** in the menu tree.
- 6) Select one of the following options:
  - If client logs are to be recorded for the desired subscriber, select the **Log Debug Messages (Verbose)** check box.
  - If you do not want client logs are to be recorded for the desired subscriber, clear the **Log Debug Messages (Verbose)** check box.

---

**INFO:** The recording of client logs is supported only for the UC Suite clients used with Microsoft Windows operating systems.

---

- 7) Click on **Save**.
- 8) If you want to enable or disable the recording of client logs for further subscribers, repeat steps 4 through 7.

## **24.9.1.4 How to Configure the Storage Path for Client Log Files**

### **Prerequisites**

- You are logged into the WBM with the **Expert** profile.

### **Step by Step**

- 1) In the navigation bar, click on **Expert Mode**.
- 2) In the navigation tree, click on **Applications > OpenScape Business UC Suite**.
- 3) Click on **Server**, followed by **Logging**.
- 4) In the field **Client Log Path:**, enter the storage path in which the `CC-Logs` directory with the individual subdirectories of the UC Suite clients and their client log files are to be stored. Select one of the following options:
  - If the `CC-Logs` directory is to be stored on every client PC, enter the following, for example: `<Drive>:\<Path>`.
  - If the `CC Logs` directory is to be stored on a central PC or server on the network, enter the following, for example: `\\<IP address>\<Drive>\<Path>`.

## Maintenance

### Monitoring and Maintaining the UC Suite

---

**INFO:** The storage of client logs is supported only for the UC Suite clients used with Microsoft Windows operating systems.

---

- 5) Click on **Save**.

#### 24.9.1.5 How to Enable or Disable Central Storage of Client Logs on the Hard Disk of the Communication System

##### *Prerequisites*

- You are logged into the WBM with the **Expert** profile.

##### *Step by Step*

- 1) In the navigation bar, click on **Expert Mode**.
- 2) In the navigation tree, click on **Applications > OpenScape Business UC Suite**.
- 3) Click on **Server**, followed by **Logging**.
- 4) Select one of the following options:
  - If you want client logs to be saved on the hard disk of the UC Booster Card (OCAB), the UC Booster Server or the OpenScape Business S communication system, select the **Enable log upload** check box.
  - If you do not want client logs to be saved on the hard disk of the UC Booster Card (OCAB), the UC Booster Server or the OpenScape Business S communication system, clear the **Enable log upload** check box.

---

**INFO:** The recording of client logs is supported only for the UC Suite clients used with Microsoft Windows operating systems.

---

- 5) Click on **Save**.

#### 24.9.1.6 How to Download the Client Logs of all Internal Stations

The **Trace** wizard can be used to download client logs (log files) of the UC Suite clients (myPortal for Desktop, myAttendant, etc.) used by internal subscribers. Client logs are supported only for the UC Suite clients used with Microsoft Windows operating systems.

##### *Prerequisites*

- You are logged on to the WBM with the **Advanced** profile.

### Step by Step

- 1) Click on **Service Center** in the navigation bar.
- 2) Click **Diagnostics > Trace** in the navigation tree.
- 3) Click on **Diagnosis Logs**.
- 4) Click on **No Log** to clear the check boxes of all logs.
- 5) Select the check box **Application Protocols**.
- 6) Select one of the following options:
  - If you want to download the entire existing log, select **Complete Trace Log** in the drop-down list.
  - If you want to download the log for today, select **Log from Today** in the drop-down list.
  - If you want to download the log for a specific time period, select **Own Selection** in the drop-down list. Then, select the beginning and end of the desired time period in the drop-down lists **From:** and **To:**.
- 7) Click on **Load** followed by **OK**. The File Download window appears.
- 8) Save the file in the desired directory. Then close the window that confirms the download of the file.
- 9) Click on **Next** followed by **Finish**.

## 24.9.2 Notification

**E-mail notifications** can be sent to the entered **Recipients** to provide advance warnings about critical disk usage levels for the hard disk, for example, or about errors.

The screenshot shows the 'Email Notifications' configuration window. The left sidebar has a tree view with 'Notifications' selected. The main content area is titled 'Email Notifications' and contains the following settings:

- Email Notifications:**
  - Enable email notifications of system errors:
  - Disable myPortal invitation email:
- Recipients:**
  - Text input field: root@localhost
- Conditions:**
  - Send Critical Messages:
  - Send Crash Notifications:
  - On error reporting, send the last:  lines from the log file.

Buttons: Save, Reset

The sending of e-mails can be linked to the following **conditions**:

## Maintenance

### Monitoring and Maintaining the UC Suite

Conditions	Default setting
Send Critical Messages	Enabled
Send Crash Notifications	Activated

The Send Critical Messages and Send Crash Notifications settings should be enabled and thus sent. These messages warn the entered recipients about a potential problem that needs to be reported to the responsible Service Support.

In addition, you can define how many of the last lines of a log file should be included with the sent e-mail. The following system errors can be reported (in English only):

System error
NULL monitor
Could not notify Call Handler
Terminate call failed
Unable to load VM Structure from file
Alsa stuck
Alsa cancel failed
MEN CallID 0
NULL alsa handle
Database connection failed
Rules engine logic failure
Config schema format failure
90% Disk usage mark
Main: Could not connect to the database !
Main: Could not load the configuration from the database!
Main: Could not open configuration file !
Main: Could not read the settings from the configuration file !
A segmentation fault was detected.
Database logic error
Database schema error
Connection Server failed to start
MultisiteSync failed to start
Multisite failed to start
TransferManager failed to start
IPC failed to start
ConferenceManager failed to start
CallManager failed to start



System error
MediaProcessing failed to start
Queues failed to start
Import failed to start
Data client failed to start
DirectoryClient failed to start
DirectoryServer failed to start
FV failed to start
IM failed to start
Switch failed to start
No Switches
Exchange Integration failed to start
Outbound Fax failed to start
SQL connection pool failed to start
Task scheduler failed to start
Trunks failed to start
Unknown switch type
Users failed to start
MEB has been disconnected
MEB ACK timeout
Switch Heartbeat timeout

### 24.9.2.1 How to Configure E-mail Notifications of System Errors

#### *Prerequisites*

- You are logged into the WBM with the **Expert** profile.

#### *Step by Step*

- 1) In the navigation bar, click on **Expert Mode**.
- 2) In the navigation tree, click on **Applications > OpenScape Business UC Suite**.
- 3) Click on **Server** followed by **Notifications**.
- 4) Select the desired setting for the e-mail notification:
  - If you want e-mail notifications, activate the **Enable e-mail notifications of system errors** check box.
  - If you do not want e-mail notifications, clear the **Enable e-mail notifications of system errors** check box.

## Maintenance

### Monitoring and Maintaining the UC Suite

- 5) Enter the e-mail addresses of the individuals to whom e-mail notifications are to be sent in the **Recipients** field. Complete the input of each e-mail address by pressing Enter so that each e-mail address is in a separate line.
- 6) Select the desired setting for critical messages
  - If you do want e-mail notifications for critical messages, activate the **Send Critical Messages** check box.
  - If you do not want e-mail notifications for critical messages, clear the **Send Critical Messages** check box.
- 7) Select the desired setting for crash notifications
  - If you do want e-mail notifications for system crashes, activate the **Send Crash Notifications** check box.
  - If you do not want e-mail notifications for system crashes, clear the **Send Crash Notifications**.
- 8) Enter the number of log file lines to be sent with an e-mail in the **Send Lines of Log File** field.
- 9) Click on **Save**.

## 24.9.3 Maintenance

Retention periods can be defined via the Maintenance for messages, for call information in the Call Journal, for calls recorded with myAgent, for faxes and e-mails received and sent for the Contact Center and for log files.

You can also set at what time the following data for which the set retention periods have expired is deleted on a daily basis:

- Messages
- Call information in the call journal (call history)
- Calls recorded with myAgent (contact center)
- Faxes and e-mails received and sent for the Contact Center
- Log files

The default setting is 2:00 a.m.

In addition, it is also possible to start the system maintenance immediately and to thus initiate the immediate deletion of the above data for which the respectively set retention periods have expired. This may be necessary, for example, if the hard disk capacity of the communication system has reached a critical level.

Section	Setting	Value	Unit
Maintenance	Begin system maintenance at	2:00 AM	
Message	Keep inbox messages for	60	Day(s)
	Keep played / read messages for	30	Day(s)
	Keep saved messages for	365	Day(s)
	Keep deleted messages for	30	Day(s)
Fax	Keep inbox faxes for	30	Day(s)
	Keep read faxes for	30	Day(s)
	Keep deleted faxes for	30	Day(s)
	Keep sent faxes for	30	Day(s)
Calls Information Maintenance	Keep call history for	30	Day(s)
	Contact Center	30	Day(s)
Log File Maintenance			

For more information on Message Maintenance, see [Voicemail Box](#).

For more information on **Maintaining Fax Messages**, see *Administrator Documentation, UC Suite*.

For more information on Calls Information Maintenance: Call History, see [Journal](#).

With **Calls Information Maintenance: Contact Center**, the calls recorded with myAgent and the received and sent faxes and e-mails for the Contact Center that have exceeded the set retention period are deleted. The default setting for the retention period for contact center data is 60 days.

---

**INFO:** The retention periods for the maintenance of the call information are independent of one another.

Contact Center reports are based on the call history. If a shorter retention period was set for the call history than for the contact center data, some reports may no longer be available.

---

During **Log File Maintenance**, the log files for which the set retention periods have expired are deleted. The default setting for the retention period for log files is 10 days.

### 24.9.3.1 How to Configure the Time for Maintenance

#### Prerequisites

- You are logged into the WBM with the **Expert** profile.

## Maintenance

Monitoring and Maintaining the UC Suite

### *Step by Step*

- 1) In the navigation bar, click on **Expert Mode**.
- 2) In the navigation tree, click on **Applications > OpenScape Business UC Suite**.
- 3) Click on **Server** followed by **Maintenance**.
- 4) Enter the time at which the daily maintenance is to be performed in the **Begin system maintenance at** field. Routine system maintenance tasks such as deleting messages, call information in the call journal, and log files for which the set retention periods have expired will then be initiated at the time specified here.
- 5) Click on **Save**.

### 24.9.3.2 How to Configure Retention Periods for Log Files

#### *Prerequisites*

- You are logged into the WBM with the **Expert** profile.

#### *Step by Step*

- 1) In the navigation bar, click on **Expert Mode**.
- 2) In the navigation tree, click on **Applications > OpenScape Business UC Suite**.
- 3) Click on **Server** followed by **Maintenance**.
- 4) Enter the retention period in days in the **Keep log information for** field. Log files are deleted when the retention period specified here expires.
- 5) Click on **Save**.

### 24.9.3.3 How to Perform Immediate System Maintenance

#### *Prerequisites*

- You are logged into the WBM with the **Expert** profile.

#### *Step by Step*

- 1) In the navigation bar, click on **Expert Mode**.
- 2) In the navigation tree, click on **Applications > OpenScape Business UC Suite**.
- 3) Click on **Server** followed by **Maintenance**.
- 4) Click on **Clear Now**.

---

**INFO:** The following items for which the set retention periods have been exceeded are deleted: messages, call information in the call journal, calls recorded with myAgent, received and sent faxes and e-mails for the contact center and the log files.

---

- 5) Click on **OK** to confirm the deletion.

### 24.9.3.4 How to Configure the Retention Period for Contact Center Data

#### *Prerequisites*

- You are logged into the WBM with the **Expert** profile.

#### *Step by Step*

- 1) In the navigation bar, click on **Expert Mode**.
- 2) In the navigation tree, click on **Applications > OpenScape Business UC Suite**.
- 3) Click on **Server** followed by **Maintenance**.
- 4) Enter the retention period in days in the **Contact Center** field. The calls recorded with myAgent and the received and sent faxes and e-mails for the contact center will be deleted if they have exceeded the retention period set here.
- 5) Click on **Save**.

## 24.10 Monitoring the UC Smart

Administrators can query the current status of the UC Smart using the WBM in **Expert** mode.

### 24.10.1 How to Query the Current Status of UC Smart

#### *Prerequisites*

- You are logged into the WBM with the **Expert** profile.

#### *Step by Step*

- 1) In the navigation bar, click on **Expert Mode**.
- 2) In the navigation tree, click on **Applications > UC Smart**.

3) Click on **Status**.

The current status of the application server and the number of active connections for each UC client is displayed.

## 24.11 Remote Services

Different Remote Services provide remote access to the communication system and the connected components to authorized service technicians. This reduces the cost of maintenance activities, while still providing users with on-site support in solving their problems.

Remote Access		Remote Access Configuration of remote access for remote administration.
SSDP V1 *(Primary)	RSP.servicelink *(Secondary)	*!Remote Access method *!RSP.servicelink Plugin should be used as primary connection.
*!Set Primary	*!Set Primary	*!Selection of primary plugin *!Select the Plugin that should be used as primary connection.
Activation / Deactivation	Activation / Deactivation	Activation / Deactivation *!Activate / Deactivate the Plugin for Remote Access.
Registration / Configuration	Registration / Configuration	Registration / Configuration *!Configure the Plugin for Remote Access.
Manage Devices		Manage Devices Manage devices for remote access via Smart Service Delivery Platform (SSDP).
	*!Not Connected	*!Connection Status *!Connected or Not Connected to the Remote Service Platform.
Code Configuration		Code Configuration *!This code is required to activate or deactivate Remote Access from system phones.

Due to the high bandwidth and the highest level of security, the Remote Service should be given precedence over RSP.servicelink. For more information see [RSP.servicelink](#).

### 24.11.1 RSP.servicelink

Remote access with RSP.servicelink connectivity (**Remote Service Platform**) offers authorized service technicians of a Remote Service Partner the option to remotely administer the communication system as well as the UC Booster applications comfortably and securely from a distance. To configure RSP.servicelink, only an Internet connection, a web browser, the partner ID and the partner password of the remote service partner are required. RSP.servicelink ensures a broadband connection with high security.

RSP.servicelink is based on OpenVPN technology. It uses the SSL/TSL protocol and encryption and provides the highest level of security with an additional client certificate. The term RSP.servicelink is abbreviated to RSP in the documentation.

RSP offers the following major advantages in combination with OpenScape Business:

- High security through outbound Internet connection  
The entire remote connection setup is always initiated by the communication system. This means that the firewall of the customer network must only allow one HTTP connection to a single address in the Remote Service Center (port 443). Under normal circumstances, no change is required in the security policies of customers or their firewalls, since this port is usually already open for outbound internet call in the firewall of the customer. High security for the customer network is thus guaranteed.  
With RSP, the administrator of the communication system retains control over the remote connection by simply enabling and disabling access. In the case of RSP.servicelink, a client certificate is automatically installed as well.
- High bandwidth  
Due to the broadband Internet connection, diagnostics data can be transmitted much faster, thus increasing the quality of service.
- Simple and cost-effective setup  
The software of the communication system already includes a so-called RSP.servicelink. When activating the service plugin, the partner ID of the Remote Service Partner and also the partner password must be entered. Every remote service partner who uses the RSP.servicelink has a separate partner ID.
- Future-proof  
RSP is the basis for future (value-added) services such as automated backups, reporting and monitoring, for example.

**Figure:** RSP - Overview for OpenScape Business X

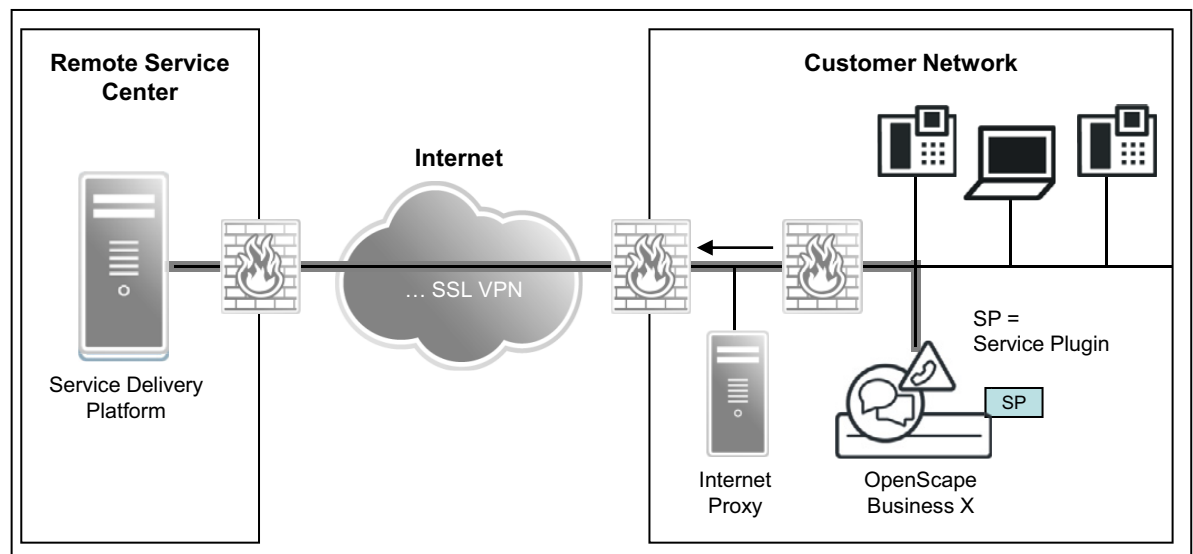

RSP supports all the usual Web Services Standards, including the Hypertext Transfer Protocol Secure (HTTPS), Simple Object Access Protocol (SOAP) and Extensible Markup Language (XML).

Communication between the client side and the Remote Service Center is always secured with an AES-256-CBC encryption for RSP.servicelink.

## Service Plugins

The RSP.servicelink plugin can be enabled or disabled individually.

The RSP.servicelink plugin must be reset after the mainboard has been replaced, for example. Resetting the service plugin deletes the entire RSP configuration and disables the plugin.

---

**INFO:** In case the system is not in DTAG mode and the RSP.servicelink plugin is active, it is not possible to change the proxy settings configuration. The **Registration / Configuration button is disabled.**

In DTAG mode, if RSP.servicelink plugin is active, pressing Registration / Configuration button shows directly Proxy Settings page with Abort/Finish buttons. This is also possible from the remote server.

---

## Device Management (Managed Device)

In communication systems without a UC Booster, remote access to further devices (e.g., Xpressions Compact) in the customer LAN can be enabled by configuration on the SIRA side. IP phones can be configured on the SIRA side by using the "Managed Devices" function.

---

**INFO:** Remote access to other OpenScope Business communication systems in the customer LAN is not possible. Each OpenScope Business must be configured for remote access.

---

## Activating/Deactivating

The following options are available for activating or deactivating the service plugins:

- Using the **Activation / Deactivation** wizard  
There is a separate activation/deactivation wizard for the RSP service plugins.
- By entering a code at the system telephone (default: activation via \*996, deactivation via #996)  
For security reasons, a 4-digit PIN must be entered in addition to the code for the activation and deactivation via a system telephone. The configuration of this PIN is performed in the WBM of the communication system with the **Advanced** profile.

## Prerequisites

- Internet access for the communication system or the HTTP proxy in the customer LAN.
- Any existing firewall in the customer LAN must be opened for Registrar:
  - <https://188.64.18.51>
  - <https://188.64.17.51>



- Any existing firewall in the customer LAN must be opened for VPN:
  - https://188.64.18.50
  - https://188.64.17.50
- A default router must be specified in the Internet configuration.

---

**INFO:** In case the system is in DTAG mode during system startup and has internet access without the RSP.serviceplugin being installed and configured, then a script will automatically install, configure and activate RSP.serviceplugin using the PartnerID and password for DTAG (device name will be the MAC address of the system). The script will also be called periodically every 10 minutes (e.g for the case where is no internet access after initial system installation). The script will not activate automatically RSP.serviceplugin in case the user has manually deactivated it.

---

### 24.11.1.1 How to Install, Configure and Register the RSP.servicelink Plugin

The **Registration / Configuration** wizard can be used to install, configure and register the RSP.servicelink Plugin for remote access to the communication system using RSP.

#### **Prerequisites**

- You are logged on to the WBM with the **Advanced** profile.

#### **Step by Step**

- 1) Click on **Service Center** in the navigation bar.
- 2) Click on **Remote Access** in the navigation tree.
- 3) Click on **Registration / Configuration**.
- 4) If the RSP.servicelink plugin is not yet installed, click on **Install** and then on **OK & Next**.
- 5) If the RSP.servicelink plugin is already installed, click **OK & Next**.
- 6) If no proxy server is used in the customer network, click **OK & Next**, since the **Proxy Parameters** do not need to be configured. Skip the next two steps.
- 7) If a proxy server is used in the customer network, you must select the **Proxy Parameters** setting depending on the customer network:
  - If a proxy with the HTTP protocol exists in the customer network, select the **Enable HTTP Proxy** check box. Enter the host name on the **HTTP Proxy Host** field and the port number of the proxy server in the **HTTP Proxy Port** field. If required, enter the user name and password required for the authentication at the proxy server in the **User Name** and **Password** fields.
  - If a proxy with the SOCKS protocol exists on the customer network, select the **Enable SOCKS Proxy** check box. Enter the host name on the

**SOCKS Proxy Host** field and the port number of the proxy server in the **SOCKS Proxy Port** field. If required, enter the user name and password required for the authentication at the proxy server in the **User Name** and **Password** fields.

---

**INFO:** The type and configuration of the proxy server determines whether or not authentication is required.

---

- 8) Click **OK & Next**.
- 9) Change the preset partner ID in the **Partner ID** field only if required.
- 10) Enter your password in the **Password** field.
- 11) Enter the device name. You can find the device with the device name in the SIRA Equipment Explorer (EqE). The MAC address of the OpenScape Business is the default entry.
- 12) Click **Finish**.

The **Connection Status** row in the **RSP.servicelink** column indicates whether the registration was successful. In the event of an unsuccessful registration, the following error messages may be displayed:

- **MAC already registered:**  
Solution: Delete the device (= OpenScape Business communication system) on the SIRA Equipment Explorer and register it again with the **Registration / Configuration** wizard.

---

**INFO:** You can find the device on the SIRA Equipment Explorer through the device name or the MAC address. The device name or the MAC address of the OpenScape Business communication system can be found in the **Service Center** under **Remote Access**.

---

- **Configuration Error:**  
Solution: Re-enter the Partner ID and Password in the **Registration / Configuration** wizard and exit the wizard correctly.
- **Wrong Credentials:**  
Solution: Re-enter the Partner ID and Password in the **Registration / Configuration** wizard and exit the wizard correctly.

### 24.11.1.2 How to Enable the RSP.servicelink Plugin

The **Activation / Deactivation** wizard can be used to disable the RSP.servicelink Plugin for remote access to the communication system using RSP.

### ***Prerequisites***

- A functioning DNS configuration is available.
- A default router for Internet access or, alternatively, a proxy server in the customer network is available.
- The RSP.servicelink Plugin is deactivated.
- You are logged on to the WBM with the **Advanced** profile.

### ***Step by Step***

- 1) Click on **Service Center** in the navigation bar.
- 2) Click on **Remote Access** in the navigation tree.
- 3) Click in the **RSP.servicelink** column on **Enable / Disable**.
- 4) Click **Activate**.

## **24.11.1.3 How to Disable the RSP.servicelink Plugin**

The **Activation / Deactivation** wizard can be used to disable the RSP.servicelink Plugin for remote access to the communication system.

### ***Prerequisites***

- The RSP.servicelink plugin is enabled.
- You are logged on to the WBM with the **Advanced** profile.

### ***Step by Step***

- 1) Click on **Service Center** in the navigation bar.
- 2) Click on **Remote Access** in the navigation tree.
- 3) Click on **Enable/ Disable** in the **RSP.servicelink** column.
- 4) Click on **Deactivate**.

## **24.11.1.4 How to Reset the RSP Service Plugin**

The **Activation / Deactivation** wizard can be used to reset the RSP Service Plugin. This deletes the entire RSP configuration and disables the plugin.

### ***Prerequisites***

- You are logged on to the WBM with the **Advanced** profile.

### Step by Step

- 1) Click on **Service Center** in the navigation bar.
- 2) Click on **Remote Access** in the navigation tree.
- 3) Click in the **RSP.servicelink** column on **Enable / Disable**.
- 4) Click **Reset to Default** followed by **OK**.
- 5) Click in the **RSP.servicelink** column on **Enable / Disable**.
- 6) Click on **Deactivate**.
- 7) Delete the device on the SIRA server (= OpenScape Business communication system).

---

**INFO:** You can find the device on the SIRA server via the MAC address. The MAC address of the OpenScape Business communication system can be found in the **Service Center** under **Inventory**.

---

## 24.11.1.5 How to Configure a PIN for Activating and Deactivating the RSP.servicelink Plugin

The PIN for activating and deactivating the RSP.servicelink plugin via a system telephone.

### Prerequisites

- You are logged on to the WBM with the **Advanced** profile.

### Step by Step

- 1) Click on **Service Center** in the navigation bar.
- 2) Click on **Remote Access** in the navigation tree.
- 3) Enter the desired four-digit PIN in the **PIN** field.
- 4) Click **Save** followed by **OK**.

### Next steps

The activation of the primary service plugin via a system phone occurs by entering the corresponding code (default code = \*996), followed by the four-digit PIN.

The deactivation of the service plugins via a system phone occurs by entering the corresponding code (default code = #996), followed by the four-digit PIN.

## 24.11.2 Remote Access

Remote access can be used by authorized service technicians to access the OpenScape Business X communication systems remotely via an ISDN PSTN or

Internet connection. This ensures that support is available when solving administration tasks or performing troubleshooting.

You must enable remote access to activate remote access to the communication system. The following access methods are possible:

- Remote Access via ISDN PSTN connection

---

**INFO:** Note that for remote access via an ISDN PSTN connection, longer waiting times may be experienced due to the limited transmission speed.

---

To dial in via ISDN, the service technician needs a valid direct inward dialing phone number (**MSN/DID Number**) for the communication system.

---

**INFO:** Password for PPP authentication (CHAP password or PAP password) should be changed the first time after installation or migration, otherwise connection will not be established.

---

The UC Booster applications (e.g., UC Suite, Open Directory Service, Gate View) can be administered via this remote access if the IP address of the mainboard for the UC Booster is configured as a router (e.g., the default router).

- Remote Access via Internet Connection

---

**INFO:** Remote access via an Internet connection presents a higher security risk.

---

To dial in via the Internet, the service technician needs a special port (**Port Number**) to access the communication system. Port number 10099 is specified by default. When using an external router, port forwarding must be set up in the external router for this port number.

The port number must not be blocked by a possible firewall on the PC of the service technician. Port number selection should therefore be coordinated with the service technician.

The UC Booster Applications (e.g., UC Suite, Open Directory Service, Gate View) cannot be administered via this remote access.

You must disable remote access to block remote access to the communication system.

---

**NOTICE:** To prevent unauthorized access to the communication system, remote access must be turned off on completing the remote administration.

---

Remote maintenance of the communication system is also possible via ISDN X.75 using the Manager E service tool. The access number required for this purpose is configured in Manager E under **Digital Modem (x75)**.

### 24.11.2.1 How to Enable Remote Access via ISDN

The **Remote Access** wizard can be used to provide authorized service technicians with access to the communication system via an ISDN connection.

#### *Prerequisites*

- OpenScape Business X has an ISDN trunk connection.
- You are logged on to the WBM with the **Advanced** profile.

#### *Step by Step*

- 1) Click on **Service Center** in the navigation bar.
- 2) Click on **Remote Access** in the navigation tree.
- 3) Click on **Remote Access** to start the **Remote Access** wizard.
- 4) Activate the radio button **Remote access: on** to enable remote access.
- 5) Activate the radio button **Remote Access via: ISDN** to enable remote access via ISDN.
- 6) Enter the internal call number you want to use for remote access in the **Call No** field.
- 7) Enter the DID number you want to use for remote access in the **MSN/DID Number** field.
- 8) Click on **OK & Next** followed by **Finish**.

### 24.11.2.2 How to Configure PCs with Microsoft Windows Vista for Remote Access via ISDN

#### *Prerequisites*

- The PC is equipped with an ISDN card and has an ISDN trunk connection.
- An OpenScape Business X3/X5/X8 communication system with a point-to-point connection is to be accessed. The local area code and PABX number of the communication system are known.
- Remote access via ISDN has been enabled. The dial-in number for remote access to the communication system is available.
- The User Name and Password for accessing the communication system are known.

---

**INFO:** The following description applies to a PC with the Microsoft Windows Vista operating system. The procedure for PCs with the Microsoft Windows XP operating system is analogous to the one described below.

---

### Step by Step

- 1) Click **Start** in Windows Vista and select **Connect To**. The **Connect to a network** window appears.
- 2) Click on **Set up a connection or network**.
- 3) Click on the connection option **Connect to a workplace** and then on **Next**.
- 4) Click on **Dial directly**.
- 5) In the **Telephone number** field, enter the CO code (e.g., 0), followed by the local area code (e.g., 089), the PABX number (e.g., 12345678) and the dial-in number (e.g., 666).

The complete entry for the example above would thus be:

008912345678666

- 6) Enter a designation for this connection in the **Destination name** field.
- 7) Enable the check box **Don't connect now; just set it up so I can connect later**.
- 8) Click on **Next**.
- 9) Enter the user name for accessing the communication system in the **User name** field
- 10) and the password for accessing the communication system in the **Password** field.

---

**INFO:** The default user name and the default password for system access via the Manager E service tool are used as the default credentials for accessing the communication system.

---

- 11) Click on **Create**.
- 12) Click on **Connect now**.

This enables remote access to the communication system.

---

**INFO:** To deactivate the connection, click on **Start > Connect To**. Click on the designation of the connection defined in step 6 (**Destination name**) and then on **Disconnect**.

To activate the connection, click on the designation defined in step 6 (**Destination name**) and then on **Connect**.

---

### 24.11.2.3 How to Configure PCs with Microsoft Windows 7 for Remote Access via ISDN

#### *Prerequisites*

- The PC is equipped with an ISDN card and has an ISDN trunk connection.
- An OpenScape Business X3/X5/X8 communication system with a point-to-point connection is to be accessed. The local area code and PABX number of the communication system are known.
- Remote access via ISDN has been enabled. The dial-in number for remote access to the communication system is available.
- The User Name and Password for accessing the communication system are known.

---

**INFO:** The following description applies to a PC with the Microsoft Windows 7 operating system

---

#### *Step by Step*

- 1) Click in the **Start** menu of Windows 7 on **Control Panel**.
- 2) Click on **Network and Internet**.
- 3) Click on **Network and Sharing Center**.
- 4) Click on **Set up a connection or network**.
- 5) Click on the connection option **Connect to a workplace** and then on **Next**.
- 6) Click on **Dial directly**.
- 7) In the **Telephone number** field, enter the CO code (e.g., 0), followed by the local area code (e.g., 089), the PABX number (e.g., 12345678) and the dial-in number (e.g., 666).

The complete entry for the example above would thus be:  
008912345678666

- 8) Enter a designation for this connection in the **Destination name** field.
- 9) Enable the check box **Don't connect now; just set it up so I can connect later**.
- 10) Click on **Next**.
- 11) Enter the user name for accessing the communication system in the **User name** field
- 12) and the password for accessing the communication system in the **Password** field.

---

**INFO:** The default user name and the default password for system access via the Manager E service tool are used as the default credentials for accessing the communication system.

---



- 13) Click on **Create**.
- 14) Click on **Connect now**. The message `Connection established` then appears.
- 15) Click on **Close**.

This enables remote access to the communication system.

---

**INFO:** To deactivate the connection, click on the **Networking** icon in the toolbar. Click on the designation of the connection defined in step 8 (**Destination name**) and then on **Disconnect**.  
To activate the connection, click on the designation defined in step 8 (**Destination name**) and then on **Connect**.

---

#### 24.11.2.4 How to Enable Remote Access via Internet Access with a Fixed IP Address

The **Remote Access** wizard can be used to provide authorized service technicians with access to the communication system via an Internet connection.

##### **Prerequisites**

- You are logged on to the WBM with the **Advanced** profile.
- You have a port number which can be used for Internet access to the communication system by the service technician. This port number must not be blocked by a possible firewall on the PC of the service technician.

##### **Step by Step**

- 1) Click on **Service Center** in the navigation bar.
- 2) Click on **Remote Access** in the navigation tree.
- 3) Click on **Remote Access** to start the **Remote Access** wizard.
- 4) Activate the radio button **Remote access: on** to enable remote access.
- 5) Enable the radio button **Remote Access via: Internet** to enable remote access via the Internet.
- 6) Enter the port number you want to use for remote access in the **Port Number** field.  
  
Port number 10099 is specified by default.
- 7) Click on **OK & Next**. The message `Remote Access has been activated . . .` is displayed. This message includes the URL, via which the communication server can be accessed remotely using a web browser.
- 8) Click on **Finish**.

## 24.11.2.5 How to Enable Remote Access via Internet Access without a Fixed IP Address

The **Remote Access** wizard can be used to provide authorized service technicians with access to the communication system via an Internet connection.

### Prerequisites

- You are logged on to the WBM with the **Advanced** profile.
- You have a port number which can be used for Internet access to the communication system by the service technician. This port number must not be blocked by a possible firewall on the PC of the service technician.
- A DynDNS account is available.

### Step by Step

- 1) Click on **Service Center** in the navigation bar.
- 2) Click on **Remote Access** in the navigation tree.
- 3) Click on **Remote Access** to start the **Remote Access** wizard.
- 4) Activate the radio button **Remote access: on** to enable remote access.
- 5) Enable the radio button **Remote Access via: Internet** to enable remote access via the Internet.
- 6) Enter the port number you want to use for remote access in the **Port Number** field.  
Port number 10099 is specified by default.
- 7) Click on **OK & Next** to accept the entries. The **Configure DynDNS-Account** window appears.
- 8) Enter the user name for your DynDNS account with the DynDNS provider in the **Login Name** field if this is not already displayed.
- 9) Enter the password of your DynDNS account with the DynDNS provider in the **Password** and **Retype Password** fields if this is not already displayed.
- 10) In the **Hostname** field, enter the host name assigned to you by the DynDNS provider, but without the domain name (e.g., `myhost`) if this is not already displayed.
- 11) Select your DynDNS provider in the **Domain name** drop-down list (e.g., `dyndns.org`) if this is not already displayed. Your complete domain name would then be `myhost.dyndns.org`, for example.
- 12) Click on **Connection test**. The **Test DynDNS Access** window appears.
- 13) Click on **OK**. The DynDNS access data is now transmitted to the provider. This takes about 10 seconds.
- 14) If the test was successful, the message `Remote Access has been activated ...` is displayed. This message includes the URL, via which the communication server can be accessed remotely using a web browser. Click on **Finish**.

- 15) If the test was successful, click **OK**. Notes on the possible causes of errors, if any, will appear in the subsequent **DynDNS Access** window. Click on **OK**. The **Configure DynDNS-Account** window appears. You can now check and correct the access data you had entered (steps 8 through 11) if required). Continue as described under step 12.

### 24.11.2.6 How to Disable Remote Access

The **Remote Access** wizard can also be used to disable remote access.

#### *Prerequisites*

- You are logged on to the WBM with the **Advanced** profile.

#### *Step by Step*

- 1) Click on **Service Center** in the navigation bar.
- 2) Click on **Remote Access** in the navigation tree.
- 3) Click on **Remote Access** to start the **Remote Access** wizard. Shows whether remote access via the Internet and/or ISDN is enabled.
- 4) Activate the radio button **Remote access: off** to disable remote access.
- 5) Select the remote access option you want to disable:
  - If you want to disable remote access via the Internet, enable the **Remote Access via: Internet** radio button.
  - If you want to disable remote access via ISDN, enable the **Remote Access via: ISDN** radio button.
- 6) Click on **OK & Next**.
- 7) Click on **Back** if you also want to deactivate the second remote-access option. Repeat steps 4 through 6.
- 8) Click on **Finish**.

### 24.11.3 Online User

The Online User enables the remote control, verification and monitoring of OpenStage telephones via a Windows PC. The behavior of an OpenStage telephone is recreated via the Online User on the PC.

In order to communicate with an OpenStage phone, the phone software must have a so-called dongle key.

The following entries must be made via the Online User in order to access an OpenStage telephone:

- OpenStage phone type
- IP address of the OpenStage telephone
- Administrator password of the OpenStage telephone

Details on using the Online User can be obtained from the following documentation: *OpenStage HUSIM Phone Tester User Guide*. Access to this document is available via the intranet portal for technical product documentation at [http://apps.g-dms.com:8081/techdoc/search\\_en.htm](http://apps.g-dms.com:8081/techdoc/search_en.htm).

The Manager E service tool provides online users for the remote control, testing and monitoring of OpenStage phones.

### 24.11.3.1 How to Start the Online User

#### *Prerequisites*

- You are logged into the WBM with the **Expert** profile.

#### *Step by Step*

- 1) In the navigation bar, click on **Expert Mode**.
- 2) In the navigation tree, click on **Maintenance > Online User**. The login window of the Online User is displayed.
- 3) Select the model of the desired OpenStage telephone from the **Model** drop-down list.
- 4) Enter the IP address of the desired OpenStage telephone in the **Phone IP** field.
- 5) Enter the administrator password of the desired OpenStage telephone in the **Password** field. The default administrator password is 123456.
- 6) Select the desired transport protocol in the **Protocol** drop-down list.
- 7) Select one of the following options for the Internet Protocol Version IPv:
  - If you want to use Internet Protocol Version 4, select the option **IPv4**.
  - If you want to use Internet Protocol Version 6, select the option **IPv6**.
- 8) Select the number of key modules in the **Number of Key Modules** drop-down list.
- 9) Click on **OK** to initiate access to the desired OpenStage telephone.

---

**INFO:** Details on the operation of the Online User can be found in the *OpenStage HUSIM Phone Tester User Guide*, which can be retrieved from [http://apps.g-dms.com:8081/techdoc/search\\_en.htm](http://apps.g-dms.com:8081/techdoc/search_en.htm).

---

## 25 Migration

HiPath 3000 systems and OpenScape Business V1 systems can be migrated to OpenScape Business V2 systems.

### 25.1 Migrating from HiPath 3000 to OpenScape Business V2

This section describes the technical migration of HiPath 3000 V9 standalone systems and HiPath 3000 internetworks to OpenScape Business V2.

The following communication systems and internetworks can be migrated:

- HiPath 3000 standalone system
- HiPath 3000 standalone system with OpenScape Office V3 HX
- HiPath 3000 Internetwork
- HiPath 3000 internetwork with HiPath 5000 RSM

---

**INFO:** Before migrating to OpenScape Business V2, the HiPath 3000 system, including all the connected devices, needs to first be made fully operational once.

---

If an OpenScape Office V3 HX is additionally connected to the HiPath 3000 communication system, this can be upgraded to an external UC Booster Server.

The upgrading of a HiPath 3000 communication system occurs by replacing the mainboard, converting the CDB and subsequently migrating the license.

---

**INFO:** All of the steps listed below to install the new hardware are described in detail in the Hardware Installation chapter of the Service Documentation.

---

The following points must be observed prior to migration:

- **Hardware compatibility check**  
Please verify whether the existing hardware can still be used. Discontinued components or devices which are no longer supported must be removed and replaced by their respective successors if required. A list can be found here [Non-Supported Boards and Devices](#)
- **Determining the power requirements**  
Since an OpenScape Business mainboard requires more power than a HiPath 3000 mainboard, the power requirements must be determined for the following scenarios (see the Appendix "Power Requirements of a Communication System" in the Service Documentation), and the OpenScape Business Powerbox should be used if required:
  - For HiPath 3000 systems without HG1500

## Migration

### Migrating from HiPath 3000 to OpenScape Business V2

- when using the UC Booster Card (OCAB)  
When migrating a HiPath 33xx/35xx to OpenScape Business X3/X5, the original power supply unit (PSU) which may still be in use must be replaced by a newer UPSC-D/-DR power supply.
- **Slot verification with X8**  
To ensure optimal ventilation of the base box, the following slot restrictions apply to a few boards:
  - **Analog subscriber line modules**  
Analog subscriber line modules must not be inserted in slot 7 directly to the right of the OCCL mainboard. Similarly, if possible, no analog subscriber line modules should be inserted in slot 5 immediately to the left of the OCCL mainboard.
  - **LUNA2 power supply unit**  
If possible, there should be at least one free slot between two LUNA2 boards.
- **Function compatibility check**  
Please inform yourself about which features are longer supported or have changed as compared to HiPath 3000. A list can be found here: [Changed Features and Interfaces](#).
- **License migration**  
Please note the information on the license migration so that all existing features can be correctly identified and applied to the new system (see [License Migration](#)).
- **Protective Grounding**  
Protective grounding via an additional ground wire is mandatory for all OpenScape Business communication systems!
- **EVM module**  
The EVM module is no longer needed. The functionality is integrated on the new mainboard in the form of UC Smart (voicemails, announcements, AutoAttendant). The voice messages and announcements of the EVM module cannot be migrated.
- **HG1500**  
The HG1500 board is no longer required. The functionality is integrated on the new mainboard.
  - **DSP channels**  
Please determine the number of DSP channels required. DSP channels are required to implement network transitions from TDM telephony to VoIP. With HiPath 3000, the DSP channels were provided by the HG1500 and its PDM modules. OpenScape Business has eight integrated DSP channels on the mainboard. For additional DSP channels, the DSP module OCCB1 (up to 40 channels) or OCCB40 (up to 100 channels) can be used.  
For more detailed information on DSP and T.38 resources, refer to chapter [System-Specific Capacity Limits](#).
  - **S<sub>0</sub> ports**  
All S<sub>0</sub> ports configured on mounted HG 1500 boards are automatically registered again on slot 0 of the communication system after the CDB conversion.

- **Dial plan in the internetwork**  
In a pure voice network, open and closed numbering are possible. When using the UC Suite, closed numbering is required in the internetwork (network-wide UC functionality). When using UC Smart, open and closed numbering are possible (node-wide UC functionality).
- **Multi-SLC**  
If multiple SLCN boards are inserted in the HiPath 3800, these are synchronized via SLC networking lines (multi-SLC). For each SLC networking line, an internal  $S_0$  station is set up. After the migration, it should be verified that the station flag **Call waiting rejection on** is disabled for this  $S_0$  station. Otherwise, problems may occur when a DECT phone attempts roaming to a base station that is connected to another SLCN board.  
If there are not SLCN or SLC16N boards and BS is plugged on  $U_{P0/E}$ , then in case of an OpenScape Business network with CMI roaming over the nodes, a CMA module is needed on the control board.

## 25.1.1 License Migration

The license migration is required to upgrade from HiPath 3000 to OpenScape Business V2. Any OpenScape Office V3 HX systems connected to HiPath 3000 can also be migrated.

### Prerequisites for License Migration

The following preconditions must be satisfied for a successful license migration:

- The latest version of the Manager E should always be used.
- An upgrade license to upgrade from HiPath 3000 to OpenScape Business V2 was ordered. This license can also be used to upgrade an OpenScape Office V3 HX, if present.
- The LAC for the upgrade license, which is required to retrieve the new license from the license server, is available.

### Upgrade License for HiPath 3000 / OpenScape Office V3 HX

Using the upgrade license, the following licenses can be transferred from the existing HiPath 3000 license file to OpenScape Business:

- IP stations (ComScendo)
- $S_{2M}/T1$  channels
- Mobility Entry (for the DISA-based mobility function)
- Xpressions Compact Announcements, Conferencing, Mobility

The following applies to the OpenScape Office V3 HX connections:

- Per OpenScape Office Standard User: 1x myPortal for Desktop, 1x Voicemail; 1x Fax applies to Standard User licenses in the HX base licenses 5/10 and individual licenses
- Per system: 1 x Company AutoAttendant
- For the following other OpenScape Office HX licenses, the corresponding number of OpenScape Business licenses are generated: myPortal for

## Migration

### Migrating from HiPath 3000 to OpenScape Business V2

Outlook, myAttendant, Application Launcher, Gate View cameras, OpenDirectory Connector, myAgent, Contact Center Fax, Contact Center Email, myReports.

Station licenses and user-oriented licenses are permanently assigned to subscribers. A sufficient number of licenses must be available for myAgent and myAttendant users.

- In the case of an OpenScape Office HX Voicemail license (voicemail functionality for all users), 500x OpenScape Business Voicemail licenses are generated.

#### License Migration of TDM Stations (only for HiPath 3000)

In OpenScape Business, subscriber licenses of type "TDM User" are required for all TDM stations (UP0, a/b, S0, DECT). No new licenses need to be purchased for existing TDM stations.

During the CDB conversion, the number of active TDM stations in the HiPath 3000 system is determined automatically. The required TDM User licenses are automatically transferred to the newly generated license file during the license migration at the CLS.

Calculation for TDM licences:

- Upgrade from HiPath 3000 V4 or older to OpenScape Business V2:  
No TDM users are calculated for cheaper / free of charge OpenScape Business upgrade licenses
- Upgrade from HiPath 3000 V5, V6 or V7 to OpenScape Business V2:  
70% of TDM users are calculated for cheaper / free of charge OpenScape Business upgrade licenses
- Upgrade from HiPath 3000 V8 to OpenScape Business V2:  
80% of TDM users are calculated for cheaper / free of charge OpenScape Business upgrade licenses
- Upgrade from HiPath 3000 V9 to OpenScape Business V2:  
100% of TDM users are calculated for cheaper / free of charge OpenScape Business upgrade licenses

The number of TDM user licenses is determined as follows:

- 1x TDM User license per active UP0 port - Phone ready, call number available
- 1x TDM User license per registered DECT phone - Call number available
- 1x TDM User license per configured a/b port (call number) for inserted boards
- 1x TDM User license per configured S0 port (call number) for active boards

CDB conversion can be performed only once. The steps for the technical migration must hence be followed precisely. It is not possible to subsequently alter the data determined.

License activation is performed offline at the CLS via a license file. The license activation procedure is described here: [Activating Licenses \(Standalone\)](#).

#### Products and Features without License Migration

No license migration is performed for the following HiPath 3000 and OpenScape Office V3 LX products and features:



- OpenStage Gate View on the Plug PC: OpenStage Gate View can continue to be operated with OpenScape Business.
- HG1500 B-channels: The board is dropped, since the functionality is integrated on the new mainboard.
- optiClient Attendant V8: does not run on OpenScape Business.  
Follow-up product: OpenScape Business Attendant
- optiClient BLF V1/V2: does not run on OpenScape Business.  
Follow-up product: OpenScape Business BLF
- HiPath TAPI 120/170 V2: does not run on OpenScape Business.  
Follow-up product: OpenScape Business TAPI 120/170
- Entry VoiceMail: The module is dropped, since it is integrated on the new mainboard
- myPortal entry web services communications clients on the plug PC.
- Base stations: licenses for base stations are no longer required.
- ITSP trunk access: licenses must be purchased to use ITSP channels for Internet telephony in OpenScape Business.
- As in the past, no licenses are required for S<sub>0</sub>, Analog and CAS trunks.
- For networking and the connection of external systems via tie lines, one network license per node must be purchased in OpenScape Business.

#### **Additional Notes**

Please note the following additional information:

- In OpenScape Business systems, all user-oriented licenses are permanently assigned to call numbers via the Administration (WBM) and are thus bound to these numbers. This requires the appropriate licenses.
- The Deskshare User (IP Mobility) feature requires a license in OpenScape Business as opposed to HiPath 3000. Additional licenses of the type "Deskshare User" must be purchased.

#### **Licensing Procedure for Migration of an Internetwork**

An existing HiPath 3000/5000 internetwork with a shared network license file must be split into standalone systems with individual license files at the CLS. After this, each node is upgraded and licensed as a standalone system. If necessary, the OpenScape Business systems can then be recombined into an internetwork with a single network license file at the CLS.

OpenScape Office V3 LX with HiPath 3000 gateways are upgraded and licensed as stand-alone systems. If necessary, the OpenScape Business systems can then be recombined into an internetwork with a single network license file at the CLS.

#### **Subscription (Linux Software for OpenScape Business Server)**

For migrations from OpenScape Office V3 HX, an SLES subscription can be set up with OpenScape Business S. The required Novell registration key is provided as a LAC on purchasing the DVD with the OpenScape Business communication software.

## Migration

Migrating from HiPath 3000 to OpenScope Business V2

---

**INFO:** The registration key used for the OpenScope Office V3 HX (hosting via the Central Update Server) is no longer required.

---

### 25.1.2 Migration of a HiPath 3000 Standalone System

In order to upgrade a HiPath 3000 standalone system to an OpenScope Business V2 communication system, the following migration steps must be completed as described below.

---

**IMPORTANT:** During the initial startup of the OpenScope Business, the charge state of the battery on the new OpenScope Business mainboard is undefined. To achieve an adequate charge state, the system must remain connected to the mains for at least 2 days. If the system is disconnected from the mains power supply when the charge state of the battery is insufficient, the activation period could potentially be blocked due to time manipulation, and the XML file required for licensing will no longer be available.

---

Perform the following migration steps in sequence:

- 1. Download the HiPath 3000 CDB from the system**  
Download the current HiPath 3000 CDB from the HiPath 3000 system using the latest version of Manager E.
- 2. Record the HG1500 settings (optional)**  
If one or more HG1500 boards are plugged in, you must note the HG1500 settings that were changed with respect to the default settings using the HG1500 WBM:
  - IP Routing
  - PSTN Routing
  - IP Firewall
  - MAC Firewall
  - Application Firewall
  - IP Accounting
  - IP Mapping
  - SNMP
- 3. Convert the HiPath 3000 CDB**  
Convert the current HiPath 3000 CDB to the OpenScope Business V2 CDB using the latest version of Manager E.
- 4. Swap out the hardware**  
Replace the old HiPath 3000 mainboard with the new OpenScope Business mainboard. Remove all HG1500 boards and all boards and subboards that are no longer supported. All OpenScope Business communication systems must be grounded with an additional ground wire.

5. **Perform the initial installation**  
Configure the communication system via the WBM with the **Initial installation** wizard. Note that the HG1500 settings you recorded earlier should also be taken into account here.
6. **Load the converted CDB**  
Load the converted CDB into the OpenScape Business V2 system using the latest version of Manager E. The OpenScape Business system will then restart automatically.
7. **Generate new license file at the CLS**  
Generate a new license file at the CLS with the LAC of the upgrade license, the configuration file (XML file) and the locking ID of OpenScape Business.
8. **Activate and assign licenses**  
License the OpenScape Business communication system within 30 days with the help of the license file.
9. **Reset LCR entries**  
If required, you can reset the configured LCR entries in the HiPath 3000 system (e.g., dial plans, routing tables, dial rules) to the default entries of OpenScape Business. This setting can be found in the WBM in the **Basic Installation** wizard.

### 25.1.2.1 How to Load the CDB from HiPath 3000

#### *Prerequisites*

- A HiPath 3000 communication system (HiPath 3300, HiPath 3350, HiPath 3500, HiPath 3550 and HiPath 3800) is available.
- All phones are connected and active.
- The latest version of Manager E is installed on the admin PC.
- The admin PC is connected to the HiPath 3000 communication system.

#### *Step by Step*

- 1) Log into Manager E at the admin PC.
- 2) Click on **File > Transmit** in the menu bar.
- 3) Click on the **Communications** tab.
- 4) Select the appropriate option in the **Access** area, depending on the type of connection from the admin PC to the communication system.
- 5) Enable the radio button **Read/write CDB** and click on **System -> PC**.
- 6) Click on **OK**. The CDB is transferred from HiPath 3000 to Manager E.
- 7) After the successful transfer, click **OK** and then on **Close**.
- 8) Click in the menu bar on **File > Save customer database as** and save the CDB on the admin PC in a folder of your choice.

## Migration

Migrating from HiPath 3000 to OpenScape Business V2

### *Next steps*

How Read out the HG1500 Settings

## 25.1.2.2 How Read out the HG1500 Settings

### *Prerequisites*

- One or more HG1500 boards are inserted.
- You are logged on to Manager E.

### *Step by Step*

- 1) In Manager E, click in the System view on the HG1500 entry. The WBM of the HG1500 opens.
- 2) Make a note of the settings that have been changed from their default settings. The HG1500 settings are not transferred during the conversion of the CDB and must be entered again in the WBM at the initial startup of OpenScape Business.

### *Next steps*

How to Convert the HiPath 3000 V9 CDB

## 25.1.2.3 How to Convert the HiPath 3000 CDB

### *Prerequisites*

- HiPath 3000 communication system (HiPath 3300, HiPath 3350, HiPath 3500, HiPath 3550 and HiPath 3800) is available.
- The admin PC is connected to the HiPath 3000 communication system.

### *Step by Step*

- 1) Click on **File > Convert customer database** in the menu bar.
- 2) Select the CDB previously stored on the admin PC and click **OK**.
- 3) Enter your **Name** and your **Contract number** as your customer data and click **Next**.
- 4) Select **OpenScape Business V2** as the **Version** and click **Next**.
- 5) Click **OK** to confirm the unsupported boards advisory messages.
- 6) Click **Yes** to confirm the window which informs you about the number of TDM users to perform the migration and proceed with the migration. The number of TDM user which will be migrated is calculated automatically.
- 7) Click **Next** to confirm the window which informs you about which boards are plugged.

- 8) Click in the menu bar on **File > Save customer database as** and save the CDB under a different name on the admin PC in a folder of your choice.
- 9) Close Manager E.

### **Next steps**

How to Replace the Hardware for HiPath 3300/3500 or  
How to Replace the Hardware for HiPath 3350/3550 or  
How to Replace the Hardware for HiPath 3800

## **25.1.2.4 How to Replace the HiPath 3300/3500 Hardware**

### **Prerequisites**

- A HiPath 3000 communication system (HiPath 3300 or HiPath 3500, rack-mount) is up and running.
- OpenScape Business Mainboard OCCMR.



### **WARNING**

#### **Risk of electric shock through contact with live wires**

Make sure that a separate protective ground wire with the required minimum cross section is available for the communication system (see Service Documentation, Hardware Installation).

---

### **Step by Step**

- 1) Switch off the HiPath 3000 system and disconnect the system's power plug.
- 2) Unplug all connectors (such as analog stations, ISDN lines, etc.) from the mainboard.
- 3) Loosen the two locking screws in the front panel of the mainboard.
- 4) Pry the mainboard loose from the backplane with two board wrenches (C39165-A7027-C26).
- 5) Using both hands, carefully slide out the HiPath 3000 mainboard horizontally from the board shelf and place it on a flat, grounded conductive surface.
- 6) Remove any existing HG1500 boards from the housing. The freed HG1500 slots can be used for additional boards.
- 7) If necessary, remove any boards that are no longer supported from the housing. The freed slots can be used for additional boards.
- 8) Remove all subboards inserted into the HiPath 3000 mainboard and plug them (if still needed and supported) into the OpenScape Business mainboard.
- 9) Remove the protective film from the battery on the new OpenScape Business mainboard.

## Migration

Migrating from HiPath 3000 to OpenScape Business V2

- 10) Using both hands, carefully slide the OCCMR mainboard horizontally into the same slot in which the HiPath 3000 mainboard was previously located.
- 11) Reconnect all connectors on the mainboard (such as analog stations, ISDN lines, etc.).

---

**INFO:** If more than 2 analog a/b ports were used in HiPath 3300 or 3500, 1 or 2 Y-adapter cables will be required in OpenScape Business. Up to 4 a/b ports can be connected through the 2 physical RJ11 sockets. Due to space constraints, the new mainboard has only 2 RJ11 sockets through which the 4 a/b stations must be connected.

---

- 12) Insert the SDHC card into the SDHC card slot of the mainboard until it snaps into place. The metal contacts of the SDHC card must point towards the mainboard.

---

**INFO:** Make sure that the write protection of the SDHC card is disabled (switch directed toward metal contacts).

---

- 13) Make sure that your communication system is properly connected to the ground wire.
- 14) Reconnect the system's power plug and power up the system.

### Next steps

How to Perform the Initial Installation

## 25.1.2.5 How to Replace the HiPath 3350/3550 Hardware

### Prerequisites

- A HiPath 3000 communication system (HiPath 3350 or HiPath 3550, wall-mount) is up and running.
- OpenScape Business Mainboard OCCM.
- In case of a migration from HiPath 3350 / 3550 to OpenScape Business X3W/ X5W the protection ground terminal has to be installed as shown in figure below. Afterwards the protection ground wire has to be connected as described within OpenScape Business V2, OpenScape Business X3/X5/X8, Installation Guide.

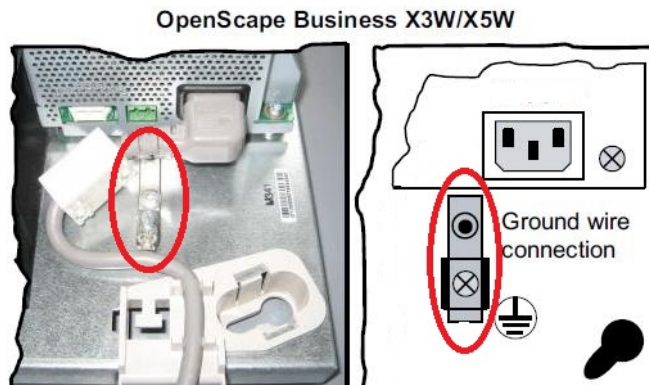

---

**WARNING**

**Risk of electric shock through contact with live wires**

Make sure that a separate protective ground wire with the required minimum cross section is available for the communication system (see Service Documentation, Hardware Installation).

---

**Step by Step**

- 1) Switch off the HiPath 3000 system and disconnect the system's power plug.
- 2) Unlatch the housing and remove it.
- 3) Remove the cover.
- 4) Unplug all edge connectors (such as analog stations, ISDN lines, etc.) from the mainboard.
- 5) Remove the board latch.
- 6) Using both hands, carefully remove the HiPath mainboard from the board shelf and place it on a flat, grounded conductive surface.
- 7) Remove any existing HG1500 boards from the housing. The freed HG1500 slots can be used for additional boards.
- 8) If necessary, remove any boards that are no longer supported from the housing. The freed slots can be used for additional boards.
- 9) Remove all subboards inserted into the HiPath 3000 mainboard and plug them (if still needed and supported) into the OpenScape Business mainboard.
- 10) Remove the protective film from the battery on the new OpenScape Business OCCM mainboard.
- 11) Carefully insert the OpenScape Business OCCM mainboard into the same slot in which the HiPath 3000 mainboard was previously located.

## Migration

Migrating from HiPath 3000 to OpenScape Business V2

- 12) Reconnect all edge connectors on the mainboard (such as analog stations, ISDN lines, etc.). Note that the connectors for ISDN lines must first be passed through the hole of the new board latch.
- 13) Insert the SDHC card into the SDHC card slot of the mainboard until it snaps into place. The metal contacts of the SDHC card must point towards the mainboard.

---

**INFO:** Make sure that the write protection of the SDHC card is disabled (switch directed toward metal contacts).

---

- 14) Secure the new board latch.
- 15) Make sure that your communication system is properly connected to the ground wire.
- 16) Put the housing back on and latch it.
- 17) Reconnect the system's power plug and power up the system.

### Next steps

How to Perform the Initial Installation

## 25.1.2.6 How to Replace the Hardware for HiPath 3000

### Prerequisites

- A HiPath 3000 communication system is up and running.
- OpenScape Business Mainboard OCCL.



---

### WARNING

#### Risk of electric shock through contact with live wires

Make sure that a separate protective ground wire with the required minimum cross section is available for the communication system (see Service Documentation, Hardware Installation).

---

### Step by Step

- 1) Switch off the HiPath 3000 system and disconnect the system's power plug.
- 2) Unplug all connectors from the mainboard.
- 3) Using both hands, carefully slide out the HiPath 3000 mainboard from the board shelf and place it on a flat, grounded conductive surface.
- 4) Pull out any existing HG1500 boards from the board shelf. The freed HG1500 slots can be used for additional boards.



- 5) If present, remove any boards that are no longer supported from the board shelf. The freed slots can be used for additional boards.
- 6) Remove all subboards inserted into the HiPath 3000 mainboard and plug them (if still needed and supported) into the OpenScape Business mainboard.
- 7) Remove the protective film from the battery on the new OpenScape Business OCCL mainboard.
- 8) Carefully insert the OpenScape Business OCCL mainboard into the same slot in which the HiPath 3000 mainboard was previously located.
- 9) Plug all connectors back into the mainboard.
- 10) Insert the SDHC card into the SDHC card slot of the mainboard until it snaps into place. The metal contacts of the SDHC card must point towards the mainboard.

---

**INFO:** Make sure that the write protection of the SDHC card is disabled (switch directed toward metal contacts).

---

- 11) Make sure that your communication system is properly connected to the ground wire.
- 12) Reconnect the system's power plug and power up the system.

### **Next steps**

How to Perform the Initial Installation

## **25.1.2.7 How to Perform the Initial Installation**

The initial installation of the communication system is described in the chapter "Initial Setup of OpenScape Business X" in the subsection "Integration into the Customer LAN" (see [Integration into the Customer LAN](#)).

The initial installation includes the configuration of the system's IP address, the DHCP settings and the country and time settings.

If an HG 1500 was installed together with the HiPath 3000, the IP address of the HG 1500 should be entered as the IP address of the OpenScape Business system during the initial installation.

After the initial installation has been completed successfully, the communication system performs a restart.

### **Next steps**

How to Load the Converted CDB into the New System

## Migration

Migrating from HiPath 3000 to OpenScape Business V2

### 25.1.2.8 How to Load the Converted CDB into the New System

#### *Prerequisites*

- The hardware has been replaced.
- The admin PC is connected to the OpenScape Business communication system (via the LAN interface).
- The admin PC is configured to receive the IP address and the subnet mask from the OpenScape Business DHCP server.

#### *Step by Step*

- 1) Log into Manager E at the admin PC.
- 2) Click on **File > Open customer database** in the menu bar.
- 3) Navigate to the location of the converted OpenScape Business CDB and click **OK**.
- 4) Confirm the message with **OK**.
- 5) Click on **File > Transmit** in the menu bar.
- 6) Click on the **Communications** tab.
- 7) Enable the **IP - HiPath** option in the **Access** area and enter the IP address of the OpenScape Business communication system in the IP address field.  
Default: 192.168.1.2.
- 8) Enable the **Security** radio button.
- 9) Click on Change Password.
- 10) Enter the old and the new password and confirm with **OK**.
- 11) Enable the radio button **Read/write CDB**.
- 12) Enable the **Call Charges** and **Hardware** check boxes and click on **PC -> system**.
- 13) Click **OK**. Manager E transfers the CDB to the system.
- 14) After successful transfer of the CDB, click **OK** and then on **Close**.
- 15) Exit Manager E. The system automatically performs a restart.

#### *Next steps*

How to Generate a New License File

### 25.1.2.9 How to Generate a New License File

#### *Prerequisites*

- The LAC of the upgrade license is available.
- The registration data of the customer is available.

**Step by Step**

- 1) Log into the WBM with the **Advanced** profile.
- 2) Click on **License Management** in the navigation bar.
- 3) Make a note of the locking ID of OpenScope Business, which appears above the table.
- 4) In the navigation tree, click on **Registration**.
- 5) Enter your data and click **OK & Next**.
- 6) Click **Export data**. A configuration file (XML file) is generated with the registration data and inventory information, including the number of connected TDM stations.
- 7) Save the configuration file in a directory of your choice.
- 8) Log into the CLS with the user name and password.
- 9) Click on **License > Generate License Key** in the menu tree.
- 10) Enter the LAC of the upgrade license under **LAC** and click **Generate Key**.
- 11) Select the feature **OpenScope Business V2 Update HiPath 3000** and click again on **Generate Key**.

### License Key Generation Details

Cancel
Next >

---

**Technical Details**

With "Verify" you can check your input data and view licenses that are already generated for this Locking ID (e.g.: MAC Address) in the detail section below.

**CAUTION:** For virtual systems the Advanced Locking ID has to be used. For hardware based systems the MAC address is of relevance.

To calculate the Advanced Locking ID click here: Calculate Locking ID

\*Locking ID: 00-1A-E8-5D-EB-9A Alias Name: OSBiz-X5 LAB LAB

Locking ID of Network CLA:

Configuration File Content: </inventory\_for\_lic

SIEL-ID: SID:1324300658865

Verify
Prefill Details

OpenScope Business V1

Quantity to Use	Available Quantity	Existing Quantity New System	Max Quantity	Feature	Duration	Version	Type	Action
1	1		1	OpenScope Business V1 Upgrade HiPath 3000 V9		V1	New License	To be activated

- 12) Enter the Locking the ID of OpenScope Business in the **Locking ID** field.

## Migration

Migrating from HiPath 3000 to OpenScape Business V2

- 13) Open the configuration file with a text editor (e.g., Notepad) and copy the entire contents of the configuration file into the **Configuration File Content** field.
- 14) Click **Next** and follow the instructions to generate a new license file.

---

**INFO:** The license migration procedure can only be performed once at the CLS. Consequently, please make sure that all the details are accurate!

---

- 15) Save the new license file in a directory of your choice.

### Next steps

How to Activate a License File Offline

## 25.1.2.10 How to Activate a License File Offline

Offline license activation is described in the chapter on "Licensing" in the subsection "Activating Licenses (Standalone)" ([How to Activate Licenses Offline \(Standalone\)](#)).

### Next steps

How to Assign Licenses

## 25.1.2.11 How to Assign Licenses

The license assignment is described in the chapter on "Licensing" in the subsection "Assigning Licenses (Standalone)" ([Assigning Licenses \(Standalone\)](#)).

## 25.1.2.12 How to Reset the LCR Entries

The basic installation of the communication system is described in the chapter "Initial Setup for OpenScape Business X" in the subsection "Basic Configuration" (see [Basic Configuration](#)).

The basic installation includes the configuration of the system call number and the stations as well as access to the Internet and Internet telephony.

In the **Basic Installation** wizard, in the **Central Functions for Stations** window, you will find an additional radio button to **Delete the configured LCR data and initialize the LCR with default data**. This radio button appears only if a converted CDB was previously loaded into the system. If this radio button is

selected, the configured LCR entries in the HiPath 3000 system will be deleted and replaced by the default entries of the OpenScape Business system.

### 25.1.3 Migration of a HiPath 3000 Standalone System with OpenScape Office V3 HX

In order to upgrade a HiPath 3000 standalone system with an attached OpenScape Office V3 HX to an OpenScape Business communication system with a UC Booster, the following migration steps must be completed as described below.

The UC functionality of an OpenScape Office V3 HX is mapped to the external OpenScape Business V2 UC Booster Server.

For the OpenScape Business UC Booster Server, an upgrade to the OpenScape Business Software V1 R2.2 (Version 1, Minor Release 2, FixRelease 2) must be first performed. This must then be followed by an upgrade to the OpenScape Business Software V1 R3.3. It is only from this basic software version that an upgrade to the latest OpenScape Business V2 software can be performed.

The following UC configuration data and user data are transferred:

- Announcements
- Images
- Voicemail
- Faxes
- Journal
- Contact Center Data
- User settings
- User Profiles
- External directory
- Schedules

The following UC configuration data and user data are **not** transferred and must be reconfigured in the UC Booster Server:

- Web services (e.g., XMpp, Web Collaboration, Mobility)
- Open Directory Service
- OpenStage Gate View

#### Migration Steps

Perform the following steps in sequence:

1. **Record agent IDs** (only when using the Contact Center)  
Record the mappings of agent IDs to the stations of the UC Suite, since these assignments will not be migrated. The assignments must be reconfigured with the **UCD** wizard in the WBM of the OpenScape Business communication system.

## Migration

Migrating from HiPath 3000 to OpenScape Business V2

2. **Update OpenScape Office V3 HX**  
First update the OpenScape Office V3 HX to the V3 R3FR6 software if this has not already been performed.
3. **Create an OpenScape Office V3 HX backup set**  
Create a backup set on an external device via the WBM of OpenScape Office V3 HX.  
More detailed information can be found in the online help of the OpenScape Office Assistant.
4. **Upgrade the HiPath 3000**  
Perform the upgrade from HiPath 3000 to OpenScape Business V1 as described in the migration procedure for a standalone system. The licenses of the OpenScape Office V3 HX are transferred to OpenScape Business during the license migration at the license server. The license file contains the license data for both OpenScape Business X3/X5/X8 and the UC Suite.
5. **Integrate the UC Booster Server in the customer LAN**  
The Linux operating system SLES 11 SP4 64 bit must be installed on the new server PC (Linux server), followed by the communication software (Version V1 R2.2). For details, please refer to the *OpenScape Business Linux Server Installation Guide*.
6. **Activate the UC Booster**  
Activate the UC Booster functionality in the WBM of the OpenScape Business communication system (Basic Installation - Initial Installation - Package with UC Suite on OpenScape Business UC Booster Server) and enter the IP address of the new server PC (using the same IP address as the old server PC if possible). Make sure that the UC Suite is active on the UC Booster Server.  
For more detailed information, see the section "Initial Installation of OpenScape Business X3/X5/X8" under [How to Define the UC Solution](#).
7. **Configure the UC Booster**  
The IP address of the communication system must be specified in the WBM of the UC Booster Server.  
For more detailed information, see the section "Initial Installation of the OpenScape Business UC Booster" under [Announcing the IP Address of the Communication System](#).
8. **Convert the OpenScape Office V3 HX backup set**  
The OpenScape Office V3 HX backup set saved on the external media must be converted via a Linux script to an OpenScape Business V1 backup set. To do this, you must be familiar with Linux. The converted backup set must then be loaded into the UC Booster Server via the WBM. The UC configuration data and user data mentioned above will then be available.  
More information on how to do this can be found in this section under [How to Convert an OpenScape Office V3 HX Backup Set](#).
9. **Update the OpenScape Business UC Booster Server**  
First update the UC Booster Server to the Version V1 R3.3 and then to the latest OpenScape Business V2 software.

### 25.1.3.1 How to Convert an OpenScape Office V3 HX Backup Set

#### *Prerequisites*

- The OpenScape Business UC Booster server is operational.
- The OpenScape Office V3 HX backup set is available on the external medium.

#### *Step by Step*

- 1) Copy the OpenScape Office V3 HX backup set from the external medium to the server PC (Linux server) into the following directory:

```
/mnt/persistent/apollo/
```

- 2) Open a terminal on the server PC or connect to it with an SSH shell. You will need root privileges for this.

- 3) Navigate to the backup directory with the following command:

```
cd /mnt/persistent/backup/
```

- 4) Invoke the conversion script as follows:

```
/opt/symappl/services/backup/script/migrate.sh /mnt/  
persistent/apollo/<name of the backup set>
```

#### **Example:**

```
/opt/symappl/services/backup/script/migrate.sh /mnt/  
persistent/apollo/BackupSet_130913-0400007.tar
```

- 5) After the conversion script is run, the converted backup set can be used for the restore.

### 25.1.4 Migrating a HiPath 3000 System to OpenScape Business UC Booster

In order to upgrade a HiPath 3000 communication system to an OpenScape Business communication system with UC Booster functionality, the following migration steps must be completed as described below.

Depending on the number of UC users, a UC Booster Card or an external UC Booster Server can be used for the UC Booster functionality.

#### **Migration Steps**

Perform the following steps in sequence:

1. **Upgrade the HiPath 3000**

Perform the upgrade from HiPath 3000 to OpenScape Business as described in the migration procedure for a standalone system.

## Migration

Migrating from HiPath 3000 to OpenScope Business V2

### 2. **Alternative 1: Insert the UC Booster Card into the housing of OpenScope Business**

If you prefer the UC Booster Card, this card is plugged into the housing during the upgrade from HiPath 3000.

More details can be found in the *Service Documentation, Hardware Installation, under the section on "Boards - Description of the Boards - OCAB"*.

### 3. **Alternative 2: Integrate the UC Booster Server in the customer's LAN**

If you prefer the external UC Booster Server, the Linux operating system SLES 11 SP4 64 bit must be installed on a server PC, followed by the communication software. For details, please refer to the *OpenScope Business Linux Server Installation Guide*.

### 4. **Enabling the UC Booster manually**

The automatic activation of the UC Booster functionality is not possible a migration. Consequently, the UC Booster functionality must be activated manually in the WBM.

More information on this can be found under [How to Activate the UC Booster Manually](#).

### 5. **Configure the UC Booster**

The UC Booster functionality is configured in the WBM.

## 25.1.4.1 How to Activate the UC Booster Manually

### Prerequisites

- You are logged into the WBM with the **Expert** profile.

### Step by Step

- 1) In the navigation bar, click on **Expert Mode**.
- 2) Click in the navigation tree on **Applications > Web Services**.
- 3) In the menu tree, click on **Application Selection > Application Selection**.

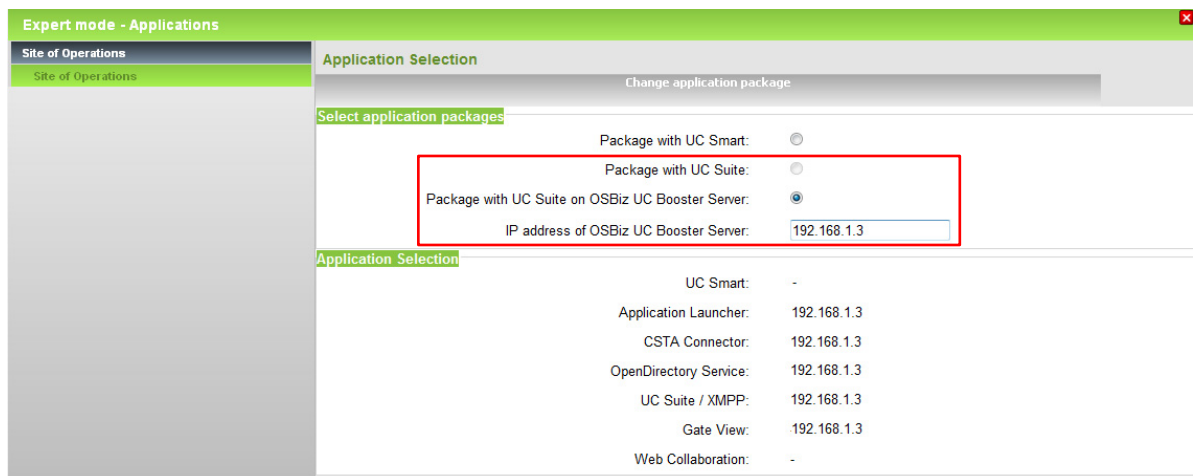

- 4) Select one of the following options:



- If you want to use the UC Booster functionality with the UC Booster Card, click on **Package with UC Suite**.
  - If want to use the UC Booster functionality with the UC Booster Server, click on **Package with UC Suite on OSBiz UC Booster Server** and, in addition, enter the IP address of the external Linux server in the **IP address of the OSBiz UC Booster Server** field.
- 5) Click **Apply**.
  - 6) Click on **Telephony > Voice Gateway** in the navigation tree.
  - 7) Click on **Voice Gateway > SIPQ-Interconnection > Application Suite** in the menu tree.

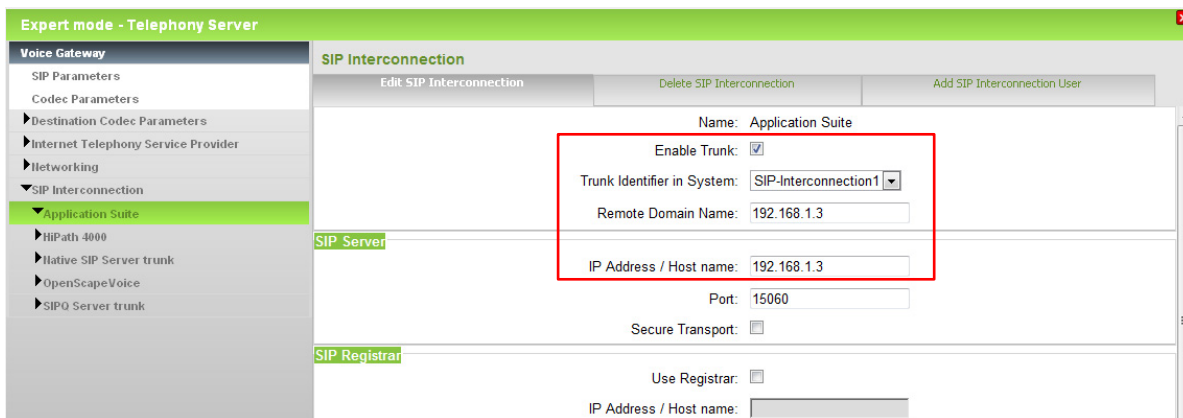

- 8) Select the **Enable Trunk** check box.
- 9) In the **Trunk Identifier in System** drop-down list, select the item **SIPQ-Interconnection 1**.
- 10) In the fields **Remote Domain Name** and **IP Address / Host name**, enter the IP address of the UC Booster Card or the UC Booster Server; for example, 192.168.1.3.
- 11) Click **Apply**.
- 12) Click in the menu tree on **SIPQ Interconnection User**.
- 13) Under **User ID**, enter the name of the `Application Suite User`. Leave the fields **Authorization name**, **Password** and **Confirm password** empty.
- 14) Click **Apply**.
- 15) In the navigation tree, click on **Telephony Server > Trunks/Routing**.
- 16) Click on **Trunks/Routing > Route > Trk Grp. 8** in the menu tree.

## Migration

### Migrating from HiPath 3000 to OpenScope Business V2

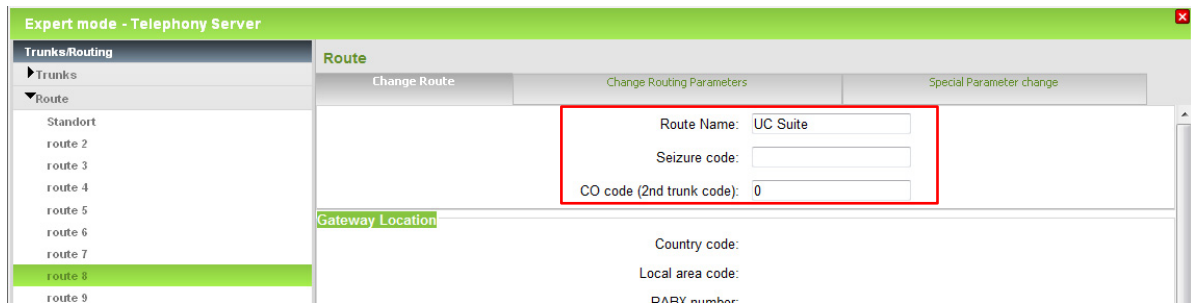

17) For Trunk Grp. 8, on the **Change Route** tab, enter the name **UC Suite** in the Route Name field.

18) Make sure that the **Seizure code** field is left empty.

19) Enter the value **0** in the **CO code (2nd trunk code)** field.

20) Click **Apply**.

21) Click the **Change Routing Parameters** tab.

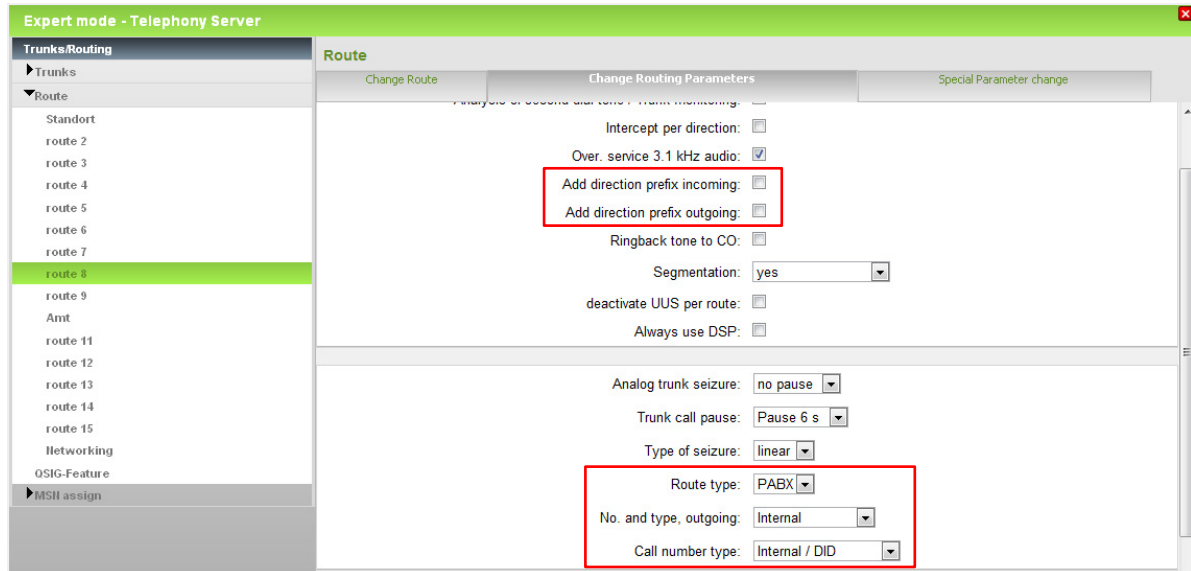

22) Clear the **Add direction prefix incoming** and **Add direction prefix outgoing** check boxes.

23) Select the item **PABX** in the **Route type** drop-down list.

24) Select the item **Group** in the **No. and type, outgoing** drop-down list.

25) In the **Call number type** drop-down list, select the item **Internal/ DID**.

26) Click **Apply**.

27) Only for Italian country initialization:

a) Click the **Special Parameter change** tab.

b) In the **Called Party Number** drop-down list, select the item **System check**,

c) Click **Apply**.

28) Click in the menu tree on **Trunks/Routing > Trunks > LAN > Box: 1 Slot: 1 > Port 4 SIPQ-Interconnection 1**,

29) Click the **Add Trunk** tab.



30) Enter the value **64** in the `Number` field.

31) Click **Apply**.

32) Click on **Port 4 SIPQ Interconnection 1** in the menu tree. All the trunks just configured will be displayed.

33) Click on a trunk and select the route **8, UC Suite**, from the `Route` drop-down list.

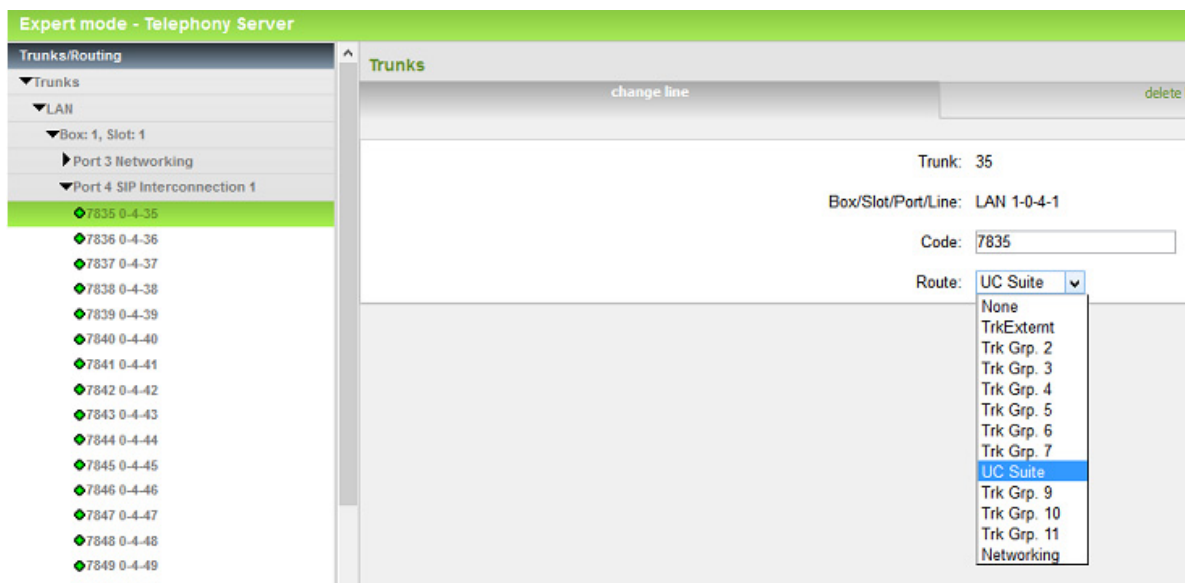

34) Click **Apply**.

35) Repeat this assignment for all required trunks.

36) Click in the navigation tree on **Telephony Server > Basic Settings**.

37) In the menu tree, click on **Basic Settings > Voicemail / Announcement Player**.

## Migration

### Migrating from HiPath 3000 to OpenScope Business V2

The screenshot shows the 'Expert mode - Telephony Server' window. On the left is a navigation tree with 'Voicemail / Announcement Player' selected. The main area is titled 'Voicemail / Announcement Player' and contains two sections: 'Voicemail' and 'Announcement Player'. In the 'Voicemail' section, the 'Prefix' field is set to '71'. In the 'Announcement Player' section, the 'Call number' field is set to '72'. Both fields are highlighted with a red box.

38) In the **Voicemail** area, in the **Prefix** field, enter the value 71 as the default phone number of the voicemail box.

39) In the **Announcement Player** area, in the **Phone Number** field, enter the value 72 as the default phone number of the announcement player.

40) Click **Apply**.

41) Click on **Telephony Server > LCR** in the navigation tree.

42) Click on **LCR > Dial Plan** in the menu tree.

The screenshot shows the 'Expert mode - Telephony Server' window with the 'LCR' section selected. The 'Dial Plan' configuration page is displayed, showing a table of dial plans. The table has columns for 'Dial Plan', 'Name', 'Dialed digits', 'Routing Table', 'Acc. code', 'Classes of service', and 'Emergency'. Rows 31 and 35 are highlighted with a red box.

Dial Plan	Name	Dialed digits	Routing Table	Acc. code	Classes of service	Emergency
23	Standard	856C1Z	7		<input checked="" type="checkbox"/>	<input type="checkbox"/>
24	Standard	856CNZ	7		<input checked="" type="checkbox"/>	<input type="checkbox"/>
25	Standard	857CZ	8		<input checked="" type="checkbox"/>	<input type="checkbox"/>
26	Standard	857C1Z	9		<input checked="" type="checkbox"/>	<input type="checkbox"/>
27	Standard	857CNZ	9		<input checked="" type="checkbox"/>	<input type="checkbox"/>
28	Standard	858CZ	10		<input checked="" type="checkbox"/>	<input type="checkbox"/>
29	Standard	858C1Z	11		<input checked="" type="checkbox"/>	<input type="checkbox"/>
30	Standard	858CNZ	11		<input checked="" type="checkbox"/>	<input type="checkbox"/>
31	Appl-Suite	-71	12		<input checked="" type="checkbox"/>	<input type="checkbox"/>
32	Standard	88CZ	1		<input checked="" type="checkbox"/>	<input type="checkbox"/>
33	IP-Network	-Z	13		<input checked="" type="checkbox"/>	<input type="checkbox"/>
34	COInternat	0C0049-Z	14		<input checked="" type="checkbox"/>	<input type="checkbox"/>
35	Ann-Player	-72	12		<input checked="" type="checkbox"/>	<input type="checkbox"/>
36	Notamt	32832-CZ	1		<input checked="" type="checkbox"/>	<input type="checkbox"/>
37			-		<input checked="" type="checkbox"/>	<input type="checkbox"/>
38			-		<input checked="" type="checkbox"/>	<input type="checkbox"/>
39			-		<input checked="" type="checkbox"/>	<input type="checkbox"/>

43) For the dial plan 31, **Appl-Suite**, and the dial plan 35, **Ann-Player**, select the route table 12 in the drop-down list in each case.

44) Click **Apply**.

## 25.1.5 Migration of a HiPath 3000 Internetwork

In order to upgrade a HiPath 3000 internetwork to an OpenScope Business internetwork, the following migration steps must be completed as described below.

### HiPath 3000 V9 Internetwork

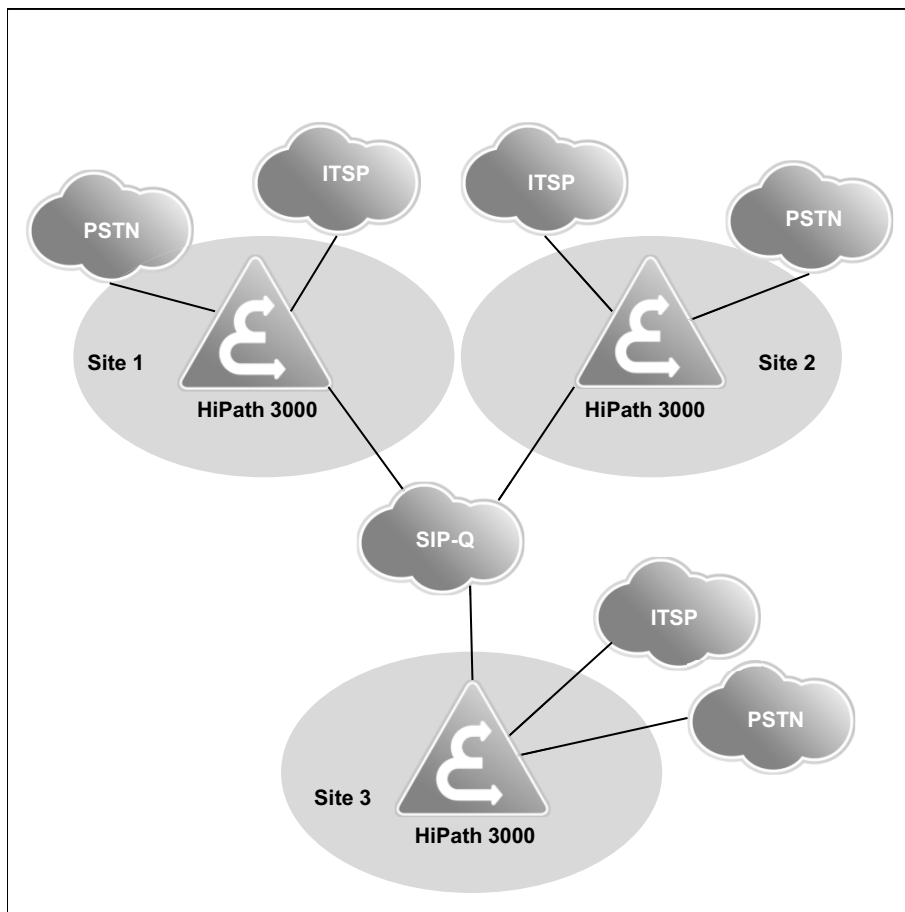

## Migration

Migrating from HiPath 3000 to OpenScope Business V2

### OpenScope Business Internetwork

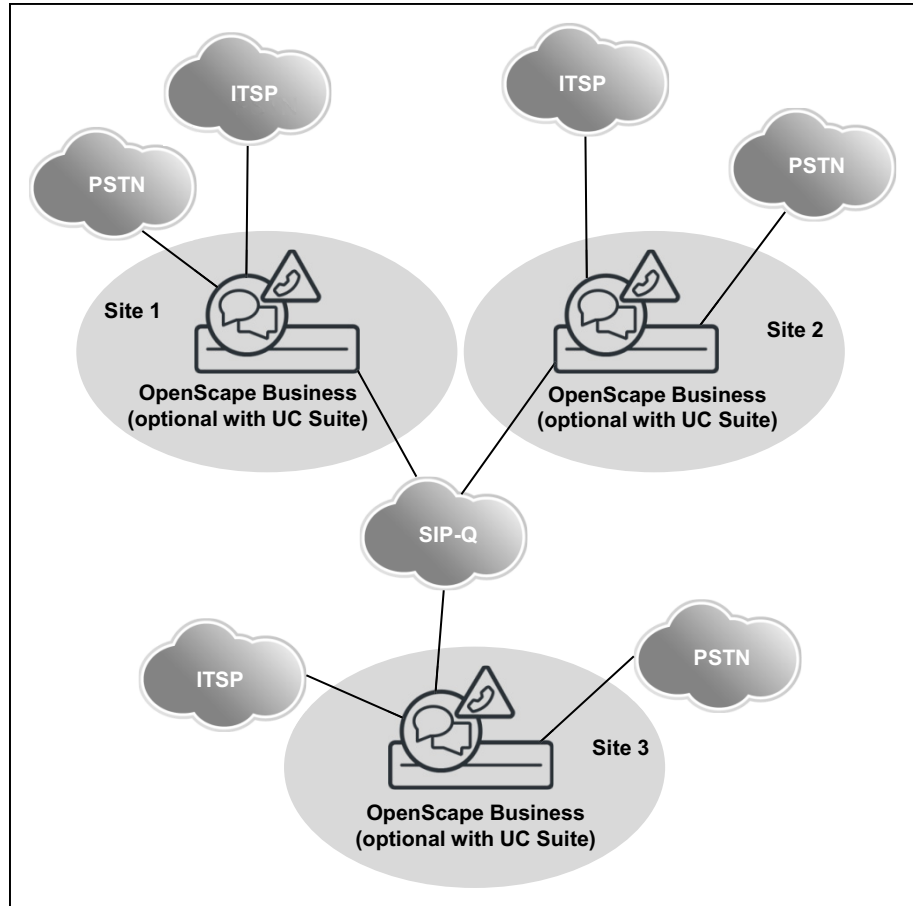

### Migration Steps

Perform the following steps in sequence:

- 1. Upgrade the HiPath 3000**  
All HiPath 3000 systems of the internetwork must be upgraded separately according to the migration description for a standalone system.
- 2. Edit the configuration**  
The following configuration parameters must subsequently be adapted using the WBM expert mode:
  - LCR entries
  - Voicemail system (hunt group, code to dial the voicemail)
  - Announcements
- 3. Execute the licensing procedure.**  
Once all systems have been upgraded, the individual license files are combined into a network-wide license at the CLS.

## 25.1.6 Migration of a HiPath 3000 Internetwork with HiPath 5000 RSM

In order to upgrade a HiPath 3000 internetwork with a connected HiPath 5000 RSM to an OpenScape Business internetwork, the following migration steps must be completed as described below. The functionality of HiPath 5000 RSM has been integrated in OpenScape Business, hence HiPath 5000 RSM itself is no longer needed in OpenScape Business internetworks.

### HiPath 3000 V9 Internetwork

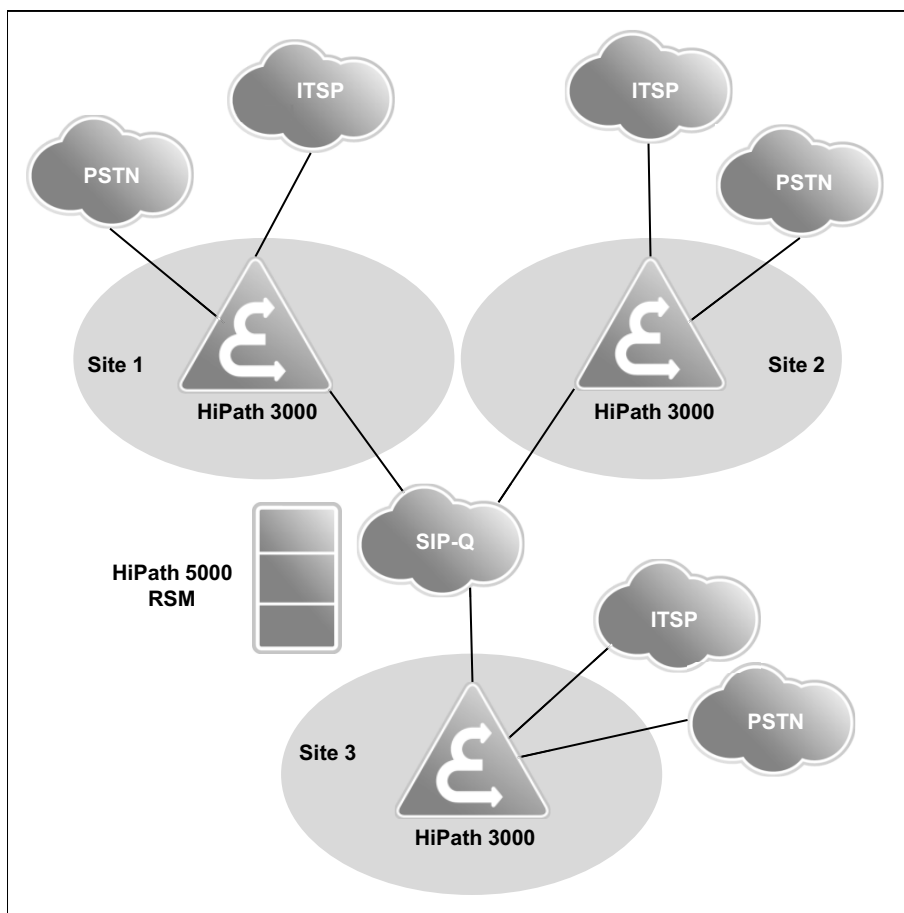

## Migration

Migrating from HiPath 3000 to OpenScope Business V2

### OpenScope Business Internetwork

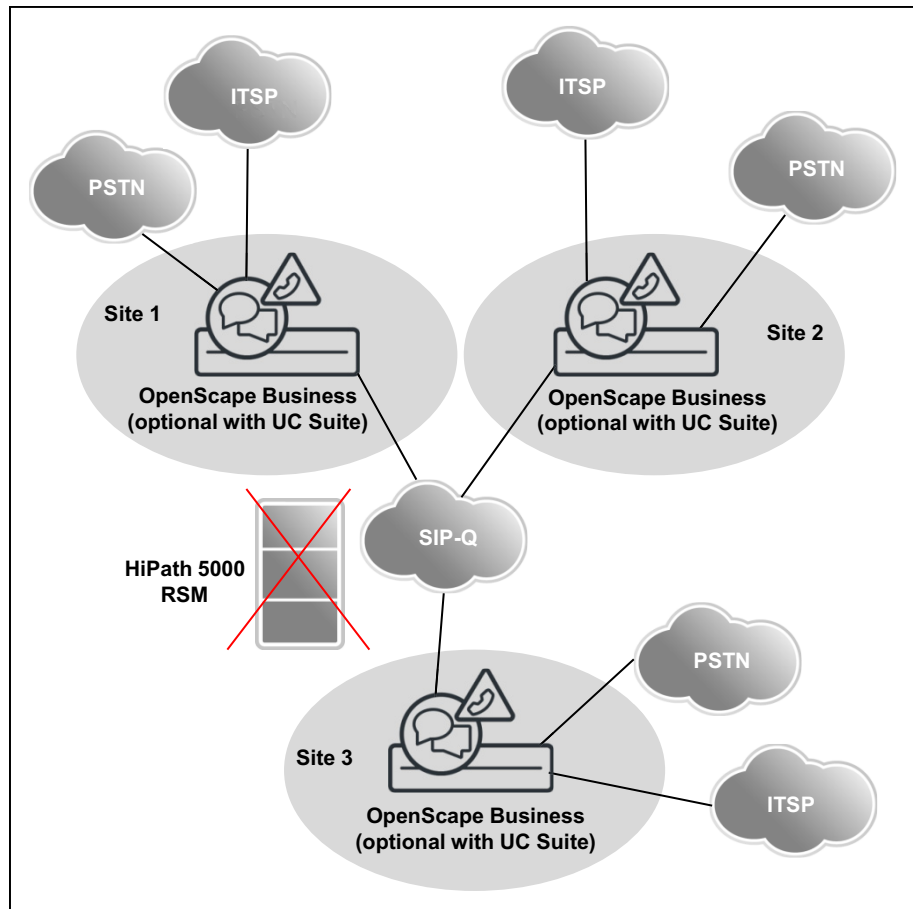

### Migration Steps

Perform the following steps in sequence:

#### 1. Split the network license file into individual license files

A HiPath 3000 internetwork with HiPath 5000 RSM uses network-wide licensing. Split the network license file into individual license files at the CLS and assign those files to the locking IDs (MAC addresses) of the HiPath 3000 V9 systems before starting the actual migration to OpenScope Business.

- First, assign the licenses of the HiPath 5000 RSM internetwork to the individual locking IDs of the HiPath 3000 nodes. Recommendation: Create an Excel list in which the individual licenses are mapped to the locking IDs of the HiPath 3000 systems.
- Contact the licensing hotline and request that the licenses be split in accordance with the Excel list.
- Download the individual licenses of the HiPath 3000 systems from the CLS and check them. There is no need to activate the licenses, i.e., to transfer them to the HiPath 3000 systems.

#### 2. Remove HiPath 5000 RSM

Make sure that HiPath 5000 RSM is switched off before upgrading the HiPath 3000 systems.



**3. Upgrade the HiPath 3000**

All HiPath 3000 systems of the internetwork must be upgraded separately according to the migration description for a standalone system.

**4. Edit the configuration**

The following configuration parameters must subsequently be adapted using the WBM expert mode:

- LCR entries
- Voicemail system (hunt group, code to dial the voicemail)
- Announcements

**5. Execute the licensing procedure.**

Once all systems have been upgraded, the individual license files are combined into a network-wide license at the CLS.

---

**INFO:** In case of a network-wide extension on UC functionality, it is necessary to change from open to closed numbering in order to adapt the internal numbers. Thus, the open numbering must be disabled, while the node number must be deleted and subsequently added as a prefix (for example, extended internal number 87100 instead of 100 and 88100 instead of 100).

Differences:

- The selection of participants in their own node is made with the extended internal number.
  - The internal number and the DID number may differ if necessary, but the DID numbers must not be changed.
- 

## 25.1.7 Changed Features and Interfaces

Some HiPath 3000 features and interfaces have been adapted for OpenScape Business and enhanced in functionality.

### Replacing the SDHC Card

For technical reasons, the SDHC card cannot be replaced while the system is switched on (a procedure which is known as speed update for HiPath 3000). Furthermore, the SDHC card of a licensed system A cannot be used for another system B because the license is bound to the locking ID of mainboard A. If the SDHC card is to be used in System B, it must be first initialized with new software by using the Card Manager.

### Enhanced SIP Functionality

The following SIP features have been additionally implemented as compared to HiPath 3000:

- Call completed elsewhere
- Message Waiting Indication for Voicemail
- Calling Name Presentation (CNIP)

## Migration

Migrating from HiPath 3000 to OpenScope Business V2

- Distinctive Ringing (internal/external calls)
- 3rd Party Call Control
- Call Forwarding busy/no reply/unconditional (handset controlled)

### Extension of SIP Trunking

To connect external SIP servers (e.g., OpenScope Alarm Server, OpenScope 4000, OpenScope Voice or UC Suite), additional native SIP/SIP-Q routes are available in OpenScope Business (as opposed to only one SIP-Q route in HiPath 3000). Thus, in addition to the classical routes for the CO, networking and ITSP, independent native SIP/SIP-Q trunk interfaces (called the SIP Interconnection) are provided for certified SIP applications.

See [Networking OpenScope Business](#)

### LCR

Routing tables 1 to 15 are intended for default entries or for configuration using wizards. During a migration, the existing entries in the HiPath 3000 are not transferred to these routing tables. Manual post-processing of the routing tables is therefore required.

### Simplified Dialing

Either the "LCR" function or the "Prime Line (Simplified dialing)" function can be activated but not both at the same time. For this reason, "LCR" is activated automatically during migration while "Prime Line (Simplified dialing)" is deactivated. To deactivate "LCR" and to activate "Prime Line (Simplified dialing)", the Basic Installation wizard must be completed before the relevant flags can be set in Manager E (not for OpenScope Business X1 because it does not allow administration via the Manager E).

---

**INFO:** Simplified dialing is not supported in CSTA applications.

---

### VoIP over PPP via ISDN

Routed voice calls over lines with low bandwidth are no longer supported.

### G. 723 support

G.723 codecs are no longer supported.

### Babyphone

The Babyphone (room monitoring) feature is no longer supported. Since "CSTA monitoring" is always active (a system phone can be monitored by an application such as myAgent or myPortal, for example), "room monitoring" can no longer be activated for this system phone. During CDB conversion with Manager E, the code for activating the room monitor is deleted.

### Number of Base Stations and DECT Telephones at OpenScope Business X3

The number of base stations at OpenScope Business X3 was increased from 3 to 7 as compared to HiPath 33xx. The number of DECT telephones at

OpenScape Business X3 was increased from 16 to 32 as compared to HiPath 33xx.

### **entry Web Services**

The entry Web Services are no longer supported. The successor to myPortal entry is called myPortal Smart and provides extended functionality. myPortal for Mobile has been replaced by myPortal to go (Web Edition). The Plug PC is no longer required in order to use myPortal to go and myPortal Smart.

### **OpenStage Gate View based on the Plug PC**

OpenStage Gate View can continue to operate on the Plug PC. The settings for the OpenStage phones should be checked.

### **External Voicemail**

If the HiPath 3000 uses neither EVM nor IVM but an external voicemail solution such as Xpressions, OpenScape Office HX or the IVM of another node, the ten EVM ports must be changed from "PhoneMail" to "Standard" in Manager E after CDB conversion.

### **CSTA applications**

A UC Booster Card or a UC Booster Server is required for connecting CSTA applications. In an internetwork, a UC Booster Card or UC Booster Server must exist on at least one node. The applications must support the CSTAv3 protocol. Compared with HiPath 3000, changes have been implemented to the CSTA protocol. Consequently, CSTA applications at HiPath 3000 V9 may not run compatibly at OpenScape Business systems. The CSTAv2 protocol is no longer supported. No license is required for the CSTA interface.

Compared to the HiPath 3000 CSTA interface, the OpenScape Business CSTA interface has been modified as follows:

- The connection to the CSTA interface is identical for standalone and networked OpenScape Business systems. It occurs exclusively via the LAN. RS-232 (V.24) and S0 interfaces are no longer supported.
- Additional hardware and software components such as the CSTA Service Provider (CSP), HG 1500 board or HiPath 5000 RSM System are no longer required with OpenScape Business.
- The CSTA interface is still not licensed.
- A maximum of 4 CSTA links can be used for connecting external applications. In the default factory state, 3 of the 4 CSTA interfaces are preconfigured for the use of internal applications of OpenScape Business. These can optionally also be used for connecting external applications.
- The protection of the CSTA interfaces against abuse has been improved. The access mechanism has been revised.
- MULAP monitoring via CSTA is only possible if a monitor point is set on the MULAP number. Individual MUALP members cannot be monitored. If a CSTA application would nonetheless like to monitor individual MULAP members, no CSTA events will be transmitted to the application by OpenScape Business. This also applies to MULAP members who are part of a hunt group.

## Migration

### Migrating from HiPath 3000 to OpenScape Business V2

- The provided CSTA functions have been expanded. Details can be found in the OpenScape Business CSTA Interface Manual.
- The CSTA Phase II protocol version is no longer supported.
- CSTA applications to be used with OpenScape Business should be tested and released in conjunction with OpenScape Business.

For Technical Details, see:

- [Application Connectivity](#)
- [http://wiki.unify.com/wiki/OpenScape\\_Business](http://wiki.unify.com/wiki/OpenScape_Business)

### TAPI 120/170 V2

For TAPI 120/170 V2, the existing licenses cannot be transferred. New licenses must be purchased. TAPI 120/170 V2 must be uninstalled, and OpenScape Business TAPI 120/170 V1 must be installed and configured instead. TAPI licenses can be configured in OpenScape Business on a user basis, thus eliminating the need for TAPI licensing within the TAPI device. Licensing is only required as of the first TAPI user (so even TAPI120 is thus no longer license-free for the first 6 users). The CMD (CSTA Message Dispatcher) is integrated in OpenScape Business. A separate Windows server for the CMD is therefore no longer required. Connectivity to external TAPI applications is possible for OpenScape Business and OpenScape Business S. OpenScape Business requires a UC Booster Card or a UC Booster Server. In an internetwork, either an OpenScape Business S must exist, or a UC Booster Card or UC Booster Server on at least one node.

Compared to HiPath TAPI 120/170 V2, the OpenScape Business TAPI 120/170 V2 V1 has been modified as follows:

- Access to the system is only possible via Ethernet LAN. RS-232 und S0 interfaces are no longer supported.
- New shared TAPI license on a "per user" basis for TAPI 120 TSP und TAPI 170 TSP.
- The licenses are bound to the locking ID of OpenScape Business.
- Existing HiPath TAPI 120 TSP or HiPath TAPI 170 TSP user licenses are not supported by the new licensing mechanism.
- No backward compatibility with HiPath 3000 V8 or V9
- The following applies for TAPI 170 TSP:
  - By default, access to the system occurs via Port 8800.
  - The configuration of the CSTA credentials in the setup dialog is mandatory.
  - Multi-node support in the network via the CSP of the central master node.
- The following applies for TAPI 120 TSP:
  - By default, access to the system occurs via Port 8900.
  - Single-node support, even when connected to the master node of a network.

For Technical Details, see:

- [Application Connectivity](#)

### Accounting Interface

The interfaces of the accounting data have changed compared to HiPath 3000.

### V24 applications

V24 applications are no longer supported.

### Other External Applications

Please observe the notes and limitations listed in the Release Notice for externally connected applications.

### HiPath 5000 RSM

HiPath 5000 RSM is no longer supported. The functionality of HiPath 5000 RSM has been integrated into OpenScape Business. Consequently, no separate server is required.

Feature	HiPath 5000 RSM	OpenScape Business
Network-wide licensing, assignment of licenses to the individual nodes	All system licenses of the network are combined at the CLS into a network-wide license.	All system licenses of the network are combined at the CLS into a network-wide license.
Network-wide administration	DB Feature Server: all nodes of the network are combined into a network CDB using Manager E. The numbering scheme is synchronized across the network.	All nodes of the network are recorded through the WBM with a network wizard. The numbering scheme is synchronized network-wide (closed numbering).
Connection to external nodes or external applications	SIP-Q connection of up to 4 external nodes	Up to 8 SIP interconnection routes with SIP-Q or Native SIP
Resilience / Survivability	User survivability for HFA phones with closed numbering	User survivability for HFA phones with closed numbering (change from OpenScape Business S <-> OpenScape Business X3/X5/X8)
Backup / Restore	Netwide	Local
Inventory function	Netwide	Local

## Migration

Migrating from HiPath 3000 to OpenScape Business V2

Feature	HiPath 5000 RSM	OpenScape Business
Presence Manager	Network-wide function with the provision of 5000 RSM	Network-wide function with the provision of a multi-node CSP based on the OpenScape Business UC Booster Card, the OpenScape Business UC Booster Server or OpenScape Business S
TAPI 170 on a standalone system	TAPI 170 on a standalone system runs on a Windows PC with its own licensing (separate license file for the TAPI 170).	TAPI 170 on a standalone system runs on a Windows PC. The license request and supply of the TAPI 170 database occurs from the SQL DB of OpenScape Business. The connection of the TAPI 170 occurs via the CSP of the system (OpenScape Business UC Booster Card, OpenScape Business UC Server Booster or OpenScape Business S)
TAPI 170 in an Internetwork	TAPI 170 runs on 5000 RSM with its own licensing (separate license file for the TAPI 170). The TAPI 170 database is obtained from the DB Feature Server of the 5000 RSM.	As with the standalone system, but the connection of the TAPI 170 occurs at the multinode CSP of a master node (i.e., network-wide).

### Mixed Networks

Mixed internetworks consisting of OpenScape Business und OpenScape Office are not supported.

## 25.1.8 Non-Supported Boards and Devices

Some boards and devices cannot be used in the OpenScape Business X3/X5/X8 communication systems for technical reasons.

These boards and devices must therefore be removed when migrating from HiPath 3000 V9 to OpenScape Business. If required, the respective follow-up board or device can be used instead.

Board/Device	Part Number	Used in	Function	Notes / Successor
ALUM4	S30817-Q935-A	X3W X5W	Switching of up to 4 analog CO trunks to up to 4 analog phones in the event of a power failure	ALUM4 must be removed. TLANI2 (S30810-Q2953-xxxx) and TLANI4 (S30810-Q2953-xxxx) to provide 2 trunk switches each.
ANI	S30807-Q6917-A103	X3W X5W	Provision of CLIP for up to 4 CO trunks	ANI must be removed. CLIP function integrated on TLANI2 (S30810-Q2953-xxxx), TLANI4 (S30810-Q2953-xxxx) and TLANI8 (S30810-Q2954-xxxx)
ANIR	S30807-Q6917-Z103	X3R X5R	Provision of CLIP for up to 4 CO trunks	ANIR must be removed. CLIP function integrated on TLANI4R (S30810-K2953-xxxx)
CBCC	S30810-Q2935-Axxx	X3W X5W	Mainboard (central control)	CBCC must be removed. OCCM (S30810-Q2959-X)
CBRC	S30810-Q2935-Zxxx	X3R X5R	Mainboard (central control)	CBRC must be removed. OCCMR (S30810-K2959-Z)
CBSAP	S30810-Q2314-X	X8	Mainboard (central control)	CBSAP must be removed. OCCL (S30810-Q2962-X)
CMS	S30807-Q6928-X	X3R X3W X5R X5W X8	Provision of a high-precision clock	CMS must be removed. Functionality integrated on OCCL/ OCCM/OCCMR
EVM	S30807-Q6945-X	X3R X3W X5R X5W	Provision of VoiceMail	EVM must be removed. Functionality integrated on OCCL/ OCCM/OCCMR
EXMNA (for U.S. only)	S30807-Q6923-X	X3W X5W	Enables the connection of an external music source	EXMNA must be removed. Use of a different option for the connection of an external music source required

## Migration

Migrating from HiPath 3000 to OpenScape Business V2

Board/Device	Part Number	Used in	Function	Notes / Successor
GEE12 GEE16 GEE50	S30817-Q951-Axxx	X3W X5W	Call detail recording with 12 kHz/16 kHz/50 Hz pulses for up to 4 CO trunks	GEE12, GEE16 and GEE50 must be removed.  Call detail recording integrated on TLANI2 (S30810-Q2953-xxxx), TLANI4 (S30810-Q2953-xxxx) and TLANI8 (S30810-Q2954-xxxx)
HOPE	S30122-Q7078-X S30122-Q7079-X	X3W X5W	Provision of Hicom Office PhoneMail Entry	HOPE must be removed.  Use of a different VoiceMail required.
HXGR3	S30810-K2943-Z1	X3R X5R	HG1500 Board	HXGR3 must be removed.  Functionality integrated on OCCMR
HXGS3	S30810-Q2943-X1	X3W X5W	HG1500 Board	HXGS3 must be removed.  Functionality integrated on OCCM
IMODN	S30807-Q6932-X100	X3R X3W X5R X5W X8	Analog modem	IMODN must be removed.  Functionality is no longer available.
LIM	S30807-Q6930-X	X3R X3W X5R X5W	Provision of one LAN interface	LIM must be removed.  Functionality integrated on OCCM/OCCMR
LIMS	S30807-Q6721-X	X8	Provision of two LAN interfaces	LIMS must be removed.  Functionality integrated on OCCL
LUNA2	S30122-K7686-A1-3 or lower S30122-K7686-A1-B1 or lower S30122-K7686-M1-9 or lower	X8	Power supply	Older LUNA2 units must be removed.  Follow-up boards: S30122-K7686-A1-4 or higher S30122-K7686-A1-C1 or higher S30122-K7686-M1-10 or higher
MMP3	S30122-K7730-X	X3W X5W	MP3 player for Music On Hold, A-law version	MMP3 must be removed.  Use of a different MP3 player for music on hold required



Board/Device	Part Number	Used in	Function	Notes / Successor
MUSIC plugin module	S30122-K5380-T200	X3W X5W	Provision of MOH (Music On Hold)	MUSIC plugin module must be removed.  Use a different option for the provision of Music On Hold required
PBXXX	S30810-Q6401-X	X8	CAS protocol converter for 1 S <sub>2M</sub> interface	PBXXX must be removed.  CAS protocol converter integrated on TMCAS2 (S30810-Q2946-X)
PDM1	S30807-Q5692-X100	X3R X3W X5R X5W	Provision of a DSP (digital signal processor)	PDM1 must be removed.  OCCB1 (S30807-Q6949-X100) or OCCB3 (S30807-Q6949-X)
PSU C	S30122-K5661-*	X5	Power supply	PSU C must be removed.  OCPSM (S30122-H7757-X)
PSU P	S30122-K5658-*	X3	Power supply	PSU P must be removed.  OCPSM (S30122-H7757-X)
STBG Only for France	S30817-Q934-A	X3W X5W	Current limitation for up to 4 CO trunks	STBG must be removed.  No follow-up board
STMI2	S30810-Q2316-X100	X8	HG1500 Board	STMI2 must be removed.  Functionality integrated on OCCL
TLA2	S30817-Q923-Bxxx	X3W X5W	Analog trunk board with 2 a/b interfaces	TLA2 must be removed.  TLANI2 (S30810-Q2953-Xxxx)
TLA4	S30817-Q923-Axxx	X3W X5W	Analog trunk board with 4 a/b interfaces	TLA4 must be removed.  TLANI4 (S30810-Q2953-Xxxx)
TLA4R	S30817-K923-Zxxx	X3R X5R	Analog trunk line with ALUM, 4 ports	TLA4R must be removed.  TLANI4R (S30810-K2953-Xxxx)
TLA8	S30817-Q926-Axxx	X3W X5W	Analog trunk board with 8 a/b interfaces	TLA8 must be removed.  TLANI8 (S30810-Q2954-Xxxx)
TMDID	S30810-Q2452-X	X8	Analog trunk board with 8 a/b interfaces	TMDID must be removed.  TMDID (S30810-Q2197-T)
TMGL2	S30810-Q2918-X100	X3W X5W	Analog trunk board with 2 a/b interfaces	TMGL2 must be removed.  TLANI2 (S30810-Q2953-Xxxx)
TMGL4	S30810-Q2918-X	X3W X5W	Analog trunk board with 4 a/b interfaces	TMGL4 must be removed.  TLANI4 (S30810-Q2953-Xxxx)

## Migration

Migrating from HiPath 3000 to OpenScape Business V2

Board/Device	Part Number	Used in	Function	Notes / Successor
TMGL4R	S30810-Q2918-Z	X3R X5R	Analog trunk board with 4 a/b interfaces	TMGL4R must be removed. TLANI4R (S30810-K2953-Xxxx)
TMQ4 For U.S. only	S30810-Q2917-X	X3W X5W	Digital trunk board with 4 S <sub>0</sub> interfaces	TMQ4 must be removed. No follow-up board
TS2	S30810-Q2913-X100	X5W	Digital trunk/tie-traffic board with one S <sub>2M</sub> interface	TS2 must be removed. TS2 (S30810-Q2913-X300)
TS2	S30810-K2913-Z100	X5R	Digital trunk/tie-traffic board with one S <sub>2M</sub> interface	TS2R must be removed. TS2 (S30810-K2913-Z300)
UAM	S30122-K7217-T	X3W X5W	Provision of Music On Hold (MOH)	UAM must be removed. The functionality is Software-based.
UAMR	S30122-K7402-T	X3R X5R	Provision of Music On Hold (MOH)	UAMR must be removed. The functionality is Software-based.
UPSC-D	S30122-K5660-X301	X3W X5W	Power supply	OCPSM (S30122-H7757-X)
UPSC-DR	S30122-K7373-X901	X3R X5R	Power supply	OCPSM (S30122-H7757-X)
V24/1	S30807-Q6916-X100	X3W X5W	Provision of a V.24 interface	V24/1 must be removed. No follow-up board
optiset and optiset E telephones	---	X3R X3W X5R X5W X8	UP0 telephone	optiset and optiset E telephones can no longer log into OpenScape Business OpenStage T
optiPoint WL2 professional HFA version	---	X3R X3W X5R X5W X8	WLAN phone	optiPoint WL2 professional SIP version

### optiPoint WL2 professional

The HFA variant of the optiPoint WL2 professional phone is not supported by OpenScape Business. A conversion from the HFA variant of the SIP variant is therefore required.

## 25.1.8.1 How to Convert an optiPoint WL2 professional from HFA to SIP

### *Prerequisites*

- The intermediate version of the phone software is available as an image file (`prep70_39.img`).
- The final version of the phone software is also available as an image file, (e.g., the standard image file `swup_70-000-52.img`).
- The user data of the WL2 and the WLAN access data are known to you.
- A new SIP subscriber, including the SIP credentials, has been set up in the WBM of the system and licensed. The SIP credentials assigned in the system are known to you.

### *Step by Step*

- 1) Upgrade to the intermediate version:
    - a) First install the intermediate version `prep70_39.img` via the WBM of the WL2 or the DLS. You can see the progress of this upgrade in the phone display.
    - b) Follow the instructions on the screen and wait until the WL2 is restarted.
    - c) After a successful start, confirm the message **Temp SW only - Please Update!** with **OK**.
  - 2) Upgrade to the final version:
    - a) Now install a standard image file such as `swup_70-000-052.img`. For security reasons, no settings and user data are changed during the upgrade. You can see the progress of this upgrade in the phone display.
    - b) Follow the instructions on the screen and wait until the WL2 is restarted.
  - 3) After a successful start, enable the default phone settings manually via the WBM of the WL2:
    - Option 1: In the WBM, navigate to **System Settings > Reset User Data > User Settings Clear**.
    - Option 2: In the WBM, navigate to **Factory Reset > Restore the factory defaults**.
- 
- NOTICE:** Your user data and the Wi-Fi access data will be lost!
- 
- 4) Enter the Wi-Fi access data at the phone to integrate the phone into the customer LAN.
  - 5) Enter the SIP credentials at the phone so that the phone can log into the system as a SIP station.
  - 6) In the WBM of the WL2, set the radio button **Network > SIP advanced > Auto Answer** to **On** to ensure the functionality of the phone in conjunction with the UC Suite clients.

## Migration

Migrating from OpenScape Office V3 MX/LX to OpenScape Business V2

## 25.2 Migrating from OpenScape Office V3 MX/LX to OpenScape Business V2

The technical migration of OpenScape Business V3 MX/LX systems to OpenScape Business V2 systems is described here.

The following communication systems can be migrated to V2:

- OpenScape Office V1 MX (hardware model)  
This requires switching to an OpenScape Business V2 hardware model, as well as a new installation.
- OpenScape Office V3 LX (Softswitch)  
The Linux operating system SLES 11 SP4 64 Bit must be installed on the Linux server, followed by the OpenScape Business V2 communication software. Operation in a virtual environment is possible.

For both systems, it is possible to import some mass data such as phone numbers with names from the old system into the new system via a CSV file. Customer data such as saved voicemails, for example, cannot be transferred.

### License Migration

The following preconditions must be satisfied for a successful license migration:

- An upgrade license to upgrade from OpenScape Office V3 MX/LX to OpenScape Business V2 was ordered.
- For the license migration of OpenScape Office V3 LX, a separate upgrade license to OpenScape Business V2 S and the OpenScape Business S/Booster Server software on DVD (SLES 11 SP4 64 bit), incl. three years of free SLES upgrades, has been ordered.
- The LAC for the upgrade license, which is required to retrieve the new license from the license server, is available.

Using the upgrade license, the following licenses can be converted from the existing OpenScape Office V3 MX/LX license file into OpenScape Business V2 licenses:

- OpenScape Office V3 LX Base 5/10/20 Comfort Plus User  
1x OpenScape Business Base, 5/10/20x IP User, 5/10/20x myPortal for Desktop, 5/10/20x Voicemail, 5/10/20x Fax, 5/10/20x Conference
- OpenScape Office V3 MX Base 10/20 Comfort Plus User  
1x OpenScape Business Base, 10/20x IP User, 10/20x myPortal for Desktop, 10/20x Voicemail, 10/20x Fax, 10/20x Conference
- Per system: 1x Company AutoAttendant, 1x Web Collaboration
- Per OpenScape Office Comfort User: 1x IP User, 1x myPortal for Desktop, 1x Voicemail
- Per OpenScape Office Comfort Plus User: 1x IP User, 1x myPortal for Desktop, 1x Voicemail; 1x Fax, 1x Conference
- For the following other OpenScape Office V3 LX licenses, the corresponding number of OpenScape Business V2 licenses are generated: myPortal for Outlook, myAttendant, Application Launcher, Gate View cameras,

OpenDirectory Connector, myAgent, Contact Center Fax, Contact Center Email, myReports

- Changes in the presence statuses for other users by myAgent users are bound in OpenScape Business to the myAttendant license. These must be ordered separately.

---

**INFO:** Station licenses and user-oriented licenses are permanently assigned to subscribers. Please ensure that an adequate number of licenses are available for myAgent and myAttendant users.

To use the Mobility features, additional user licenses must be purchased if required.

---

### **Subscription (Linux Software for OpenScape Business S)**

For migrations from OpenScape Office V3 LX, an SLES subscription can be set up with OpenScape Business S. The required Novell registration key is provided as a LAC on purchasing the DVD with the OpenScape Business communication software.

---

**INFO:** The registration key used for the OpenScape Office V3 LX (hosting via the Central Update Server) is no longer required.

---

## **25.3 Migrating from OpenScape Business V1 to V2**

The technical migration of OpenScape Business V1 systems to OpenScape Business V2 systems is described here.

The following communication systems can be migrated to V2:

- OpenScape Business V1 X (Hardware Models X1, X3, X5 and X8)
- OpenScape Business V1 S (Softswitch)
- OpenScape Business V1 UC Booster Server

### **25.3.1 Migrating an OpenScape Business V1 X System**

The following migration steps must be performed to upgrade an OpenScape Business V1 X system to an OpenScape Business V2 X system:

Perform the following migration steps in sequence:

1. **Update the OpenScape Business V1 software**

Using the WBM, update the OpenScape Business V1 software to the version V1 R3.0 or higher (see [Updating the Communication System](#)).

## Migration

### Migrating from OpenScape Business V1 to V2

2. **Load the OpenScape Business V2 license file**  
Load the OpenScape Business V2 license file into the OpenScape Business V1 system and activate the licenses (see [Activating Licenses \(Standalone\)](#)).
3. **Load the current OS Biz V2 software**  
Using the WBM, load the current OpenScape Business V2 software into the communication system. The V1 data is automatically converted to V2 data in the process (see [Updating the Communication System](#)).
4. **Perform a data backup**  
Back up your V2 data (see [Immediate Backup](#)).

---

**IMPORTANT:** If the system is upgraded from OpenScape Business V1 to OpenScape Business V2, then no ITSP activation/deactivation can be done in Internet Telephony wizard until a reset to LCR is done. Already configured ITSPs in OpenScape Business V1 will continue to work also in OpenScape Business V2 even without resetting the LCR. It is possible to edit the already activated ITSP but not to deactivate it. In order to make any activation/deactivation change in the wizard, the LCR reset is needed. This is to reflect the necessary changes for the increase of ITSPs from 4 to 8. To reset LCR, go to **Expert Mode> LCR> LCR Flags** and click the **Reset LCR Data** flag.

---

## 25.3.2 Migrating from OpenScape Business V1 S

The following migration steps must be performed to upgrade an OpenScape Business V1 S system to an OpenScape Business V2 S system:

---

**INFO:** Before performing the migration, it must be checked whether the hardware and software properties of the Linux server are appropriate for OpenScape Business V2 S. An upgrade to the Linux server (e.g., more RAM) may be sufficient. The Linux operating system SLES 11 SP4 64 bit is a prerequisite.

If a new Linux server is required, the OpenScape Business V1 S communication software must be installed after installing Linux. A V1 data backup can then be transferred and you can continue with migration step 1.

---

Perform the following migration steps in sequence:

1. **Update the OpenScape Business V1 software**  
Using the WBM, update the OpenScape Business V1 software to the version V1 R3.3 or higher (see [Updating the Communication System](#)).
2. **Load the OpenScape Business V2 license file**  
Load the OpenScape Business V2 license file into the OpenScape Business V1 system and activate the licenses (see [Activating Licenses \(Standalone\)](#)). The license for the free SLES upgrades can still be used.

3. **Load the current OS Biz V2 software**

Using the WBM, load the current OpenScape Business V2 software into the communication system. The V1 data is automatically converted to V2 data in the process (see [Updating the Communication System](#)).

4. **Perform a data backup**

Back up your V2 data (see [Immediate Backup](#)).

---

**IMPORTANT:** If the system is upgraded from OpenScape Business V1 to OpenScape Business V2, then no ITSP activation/deactivation can be done in Internet Telephony wizard until a reset to LCR is done. Already configured ITSPs in OpenScape Business V1 will continue to work also in OpenScape Business V2 even without resetting the LCR. It is possible to edit the already activated ITSP but not to deactivate it. In order to make any activation/deactivation change in the wizard, the LCR reset is needed. This is to reflect the necessary changes for the increase of ITSPs from 4 to 8. To reset LCR, go to **Expert Mode> LCR> LCR Flags** and click the **Reset LCR Data** flag.

---

### 25.3.3 Migrating an OpenScape V1 UC Business Booster Server

The following migration steps must be performed to upgrade an OpenScape Business V1 UC Booster Server to an OpenScape Business V2 UC Booster Server:

---

**INFO:** Before performing the migration, it must be checked whether the hardware and software properties of the Linux server are appropriate for the OpenScape Business V2 UC Booster Server. An upgrade to the Linux server (e.g., more RAM) may be sufficient. The Linux operating system SLES 11 SP4 64 bit is a prerequisite.

If a new Linux server is required, the OpenScape Business V1 UC Booster Server must be installed after installing Linux. A V1 data backup can then be transferred and you can continue with migration step 1.

---

Perform the following migration steps in sequence:

1. **Update the OpenScape Business V1 software**

Using the WBM, update the OpenScape Business V1 software to the version V1 R3.3 or higher (see [Updating the Communication System](#)).

2. **Load the OpenScape Business V2 license file**

Load the OpenScape Business V2 license file into the OpenScape Business V1 system and activate the licenses (see [Activating Licenses \(Standalone\)](#)). The license for the free SLES upgrades can still be used.

## Migration

Migrating from OpenScape Business V1 to V2

3. **Load the current OS Biz V2 software**  
Using the WBM, load the current OpenScape Business V2 software into the communication system. The V1 data is automatically converted to V2 data in the process (see [Updating the Communication System](#)).
4. **Perform a data backup**  
Back up your V2 data (see [Immediate Backup](#)).

### 25.3.4 Migrating from OpenScape Business V1 Network to OpenScape Business V2 Network

The update of all nodes in a network must be performed immediately. Nevertheless, for a practical use of a software update process, it is allowed to operate with a heterogeneous network with V1 and V2 software for an intermittent timeframe. The complete feature functionality is not guaranteed during this time period.

---

**INFO:** Before performing the migration, check whether the system hardware and software properties are appropriate for OpenScape Business V2.

---

#### Migration Steps

Perform the following steps in sequence:

1. **Upgrade like a single system every OpenScape Business system with local licensing (local CLA) within a network he HiPath 3000**  
Every OpenScape Business system with local licensing (local CLA) within a network has to be upgraded as described in the migration procedure for a standalone system (see [Migration of a HiPath 3000 Standalone System](#) Migration of a HiPath 3000 V9 Standalone System).
2. **Perform the following steps in sequence, in order to upgrade an OpenScape V1 Network to an OpenScape V2 Network with central licensing:**
  - a) **Update the OpenScape Business V1 software**  
Using the WBM, update the OpenScape Business V1 software to the version V1 R3.3 or higher (see [Updating the Communication System](#)).
  - b) **Perform data backup**  
Back up your V1 data (see [Immediate Backup](#)).
  - c) **Load the OpenScape Business V2 license file**  
Load the OpenScape Business V2 license file into the OpenScape Business V1 system (Master) and activate the licenses
  - d) **Load the current OpenScape Business V2 software**  
Using the WBM, load the current OpenScape Business V2 software into all communication systems of the network. First upgrade the Master system and continue with the Slave nodes immediately. The V1 data is automatically converted to V2 data during this process (see [Updating the Communication System](#)).



---

**INFO:** In case slave node(s) in the system has not been upgraded yet, that node can use the licenses defined in the V1 license file for 180 more days. When the last 30 days start, a message appears on the display of the V1.

---

### 3. Perform data backup

Back up your V2 data (see Immediate Backup).

You have migrated OpenScape Business V1 Network to OpenScapeBusiness V2 Network.

## 25.4 Migration within OpenScape V2 Business

The various migration options within OpenScape Business V2 systems are described here.

### Increasing the Number of UC Smart Users

You can choose from the following options:

- Migration of **OpenScape Business X** (UC Smart) to **OpenScape Business X with UC Booster Card** (UC Smart)  
Useful for 50 to 150 UC Smart users. All the configuration and user data is transferred. No data transfer occurs with downgrades. Additional UC Smart user licenses are required for the new UC Smart users. OpenScape Business X1 is not expandable with the UC Booster Card.
- Migration of **OpenScape Business X** (UC Smart) to **OpenScape Business X with UC Booster Server** (UC Smart)  
Useful for 50 to 500 UC Smart users. All the configuration and user data is transferred. No data transfer occurs with downgrades. Additional UC Smart user licenses are required for the new UC Smart users.
- Migration of **OpenScape Business X with UC Booster Card** (UC Smart) to **OpenScape Business X with UC Booster Server** (UC Smart)  
Useful for 150 to 500 UC Smart users. All the configuration and user data is transferred. No data transfer occurs with downgrades. Additional UC Smart user licenses are required for the new UC Smart users.

### Upgrade from UC Smart to UC Suite

You can choose from the following options:

- Migration of **OpenScape Business X** (UC Smart) to **OpenScape Business X with UC Booster Card** (UC Suite)  
The configuration and user data is not transferred. An upgrade license to UC Suite clients is required for the existing UC Smart clients. The conversion of the UC solution to UC Suite occurs in the WBM with the **Initial Installation** wizard.

## Migration

### Migration within OpenScape V2 Business

- Migration of **OpenScape Business X** (UC Smart) to **OpenScape Business X** with **UC Booster Server** (UC Suite)  
The configuration and user data is not transferred. An upgrade license to UC Suite clients is required for the existing UC Smart clients. The conversion of the UC solution to UC Suite occurs in the WBM with the **Initial Installation** wizard.
- Migration of **OpenScape Business X** with **UC Booster Card** (UC Smart) to **OpenScape Business X** with **UC Booster Server** (UC Suite)  
The configuration and user data is not transferred. An upgrade license to UC Suite clients is required for the existing UC Smart clients. The conversion of the UC solution to UC Suite occurs in the WBM with the **Initial Installation** wizard.
- Migration within **OpenScape Business S** from UC Smart to UC Suite  
The configuration and user data is not transferred. An upgrade license to UC Suite clients is required for the existing UC Smart clients. The conversion of the UC solution to UC Suite occurs in the WBM with the **Initial Installation** wizard.
- Migration within **OpenScape Business UC Booster Server** from UC Smart to UC Suite  
The configuration and user data is not transferred. An upgrade license to UC Suite clients is required for the existing UC Smart clients. The conversion of the UC solution to UC Suite occurs in the WBM with the **Initial Installation** wizard.

### Increasing the Number of UC Suite Users

You can choose from the following options:

- Migration of **OpenScape Business X** with **UC Booster Card** (UC Suite) to **OpenScape Business X** with **UC Booster Server** (UC Suite)  
Useful for 150 to 500 UC Suite users. All the configuration and user data is transferred. No data transfer occurs with downgrades. Additional UC Suite User or Groupware User licenses are required for the new UC Suite users.

### General Migration Hints

During the migration from OpenScape Business V1 to OpenScape Business V2, the Web Server process is shifted from the OCC to the Booster card (OCAB), if available. After the migration, verify that the following applications use the correct IP-Address ( IP-Adr of the OCAB ):myPortal Smart, myPortal to go, myPortal OpenStage, OpenScape Business Attendant, OpenScape TAPI120 in UC Smart Modus, Application Launcher, 3rd Party Webservice Application.

## 26 Configuration Limits and Capacities

The configuration limits and capacities are based on system-specific maximum values and the maximum values for a network.

The maximum values refer to

- the system-specific capacity limits
- the software capacities

### 26.1 System-Specific Capacity Limits

The configuration limits described here are based on system-specific maximum values for stations and trunks.

---

**NOTICE:** For each system configuration, it must be checked whether the rated power output of the native power supply is sufficient or whether an external auxiliary power supply is required (see *OpenScope Business Service Documentation - Power Requirements of a Communication System*).

---

#### Maximum values for stations

Stations	Maximum values				
	OpenScope Business				
	X1	X3R X3W	X5R X5W	X8	S
Sum total of all IP, TDM and Mobility stations	30 IP / TDM plus 30 Mobility stations	500	500	500	2000
<b>IP stations</b>					
Total of system phones, SIP stations, adapters, WLANs per communication system	20	500	500	500	2000 (max. 500 SIP stations)
<b>TDM stations</b>					
ISDN stations (S <sub>0</sub> stations) per communication system	4 (2 S <sub>0</sub> on OCCS)	20 (2 S <sub>0</sub> on OCCMR + 2 x STLSX4R)  20 (2 S <sub>0</sub> on OCCM + 2 x STLSX4)	52 (2 S <sub>0</sub> on OCCMR + 6 x STLSX4R)  52 (2 S <sub>0</sub> on OCCM + 6 x STLSX4)	128	–

**Configuration Limits and Capacities**  
System-Specific Capacity Limits

Stations	Maximum values				
	OpenScope Business				
	X1	X3R X3W	X5R X5W	X8	S
Analog stations per communication system	4 (4 a/b on OCCS)	20 (4 a/b on OCCMR + 2 x SLAV8R)  20 (4 a/b on OCCM + 1 x SLAV16)	52 (4 a/b on OCCMR + 6 x SLAV8R)  68 (4 a/b on OCCM + 4 x SLAV16)	384	–
U <sub>P0/E</sub> stations (master) per communication system	8 (8 U <sub>P0/E</sub> on OCCS)	24 <sup>1</sup> (8 U <sub>P0/E</sub> on OCCMR + 2 x SLU8R)  24 <sup>1</sup> (8 U <sub>P0/E</sub> on OCCM 2 x SLU8)	56 <sup>1</sup> (8 U <sub>P0/E</sub> on OCCMR + 6 x SLU8R)  56 <sup>1</sup> (8 U <sub>P0/E</sub> on OCCM 6 x SLU8)	384 <sup>1</sup>	–
Additional stations via OpenStage Phone Adapter (U <sub>P0/E</sub> slave phones, analog phones)	8	24  24	56  56	116	–
Cordless phones (DECT phones for the integrated Cordless solution) per communication system	16 (DECT Light)	64 (DECT Light <sup>2</sup> )	64 (DECT Light <sup>2</sup> )  64 (DECT Light <sup>2</sup> ) / 64 (1 x SLC16N)	250	–
Base stations (for the integrated Cordless solution) per communication system	7 (connection to U <sub>P0/E</sub> on OCCS (DECT Light <sup>2</sup> ))	7 (connection to U <sub>P0/E</sub> on OCCMR + 8 (connection to Up0/E on SLU8NR) (DECT Light <sup>2</sup> ))  7 (connection to U <sub>P0/E</sub> on OCCM + 8 (connection to Up0/E on SLU8NR) (DECT Light <sup>2</sup> ))	7 (connection to U <sub>P0/E</sub> on OCCMR + 8 (connection to Up0/E on SLU8NR) (DECT Light <sup>2</sup> ))  7 (connection to U <sub>P0/E</sub> on OCCM + 8 (connection to Up0/E on SLU8NR) (DECT Light <sup>2</sup> )) or 16 (connection to SLC16N)	64 (connection to 4 x SLCN)	–
<b>Mobility User</b>					

Stations	Maximum values				
	OpenScope Business				
	X1	X3R X3W	X5R X5W	X8	S
Mobility Entry: stations per communication system	30	150	150	150	250
myPortal to go (UC Smart): stations per communication system	30	250/50 <sup>2</sup>	250/50 <sup>3</sup>	250/50 <sup>3</sup>	250
myPortal to go (UC Suite): stations per communication system	–	250/100 <sup>3</sup>	250/100 <sup>4</sup>	250/100 <sup>4</sup>	250
Virtual stations (freely configurable)	30	250	250	250	250

1 Depending on the types of phones and the total power requirements of the communication system.

2 1st. value: maximum expansion with UC Booster Server or UC Booster Card/ 2nd. value: maximum expansion with mainboard

3 1st. value: maximum expansion with UC Booster Server / 2nd. value: maximum expansion with UC Booster Card

### Maximum values for trunks

Trunks	System Values				
	OpenScope Business				
	X1	X3R X3W	X5R X5W	X8	S
Total of all trunks per communication system	250 (IP and ISDN trunks)	250 (IP, ISDN and analog trunks)	250 (IP, ISDN and analog trunks)	250 (IP, ISDN and analog trunks)	250 (IP trunks) ISDN and analog trunks via gateway
<b>ISDN trunks</b>					
S <sub>0</sub> trunks	4 (2 S <sub>0</sub> on OCCS)	10 (2 S <sub>0</sub> on OCCMR + 2 x STLSX4R) 10 (2 S <sub>0</sub> on OCCM + 2 x STLSX4)	26 (2 S <sub>0</sub> on OCCMR + 6 x STLSX4R) 26 (2 S <sub>0</sub> on OCCM + 6 x STLSX4)	128 (limited by system software)	ISDN trunks via gateway
S <sub>2M</sub> trunks	–	–	30 (1 x TS2RN) 30 (1 x TS2N)	180 (3 x DIUT2)	ISDN trunks via gateway
CAS trunks	–	–	30 (1 x TCASR-2) 30 (1 x TCAS-2)	180 (3 x TMCAS2)	CAS trunks via gateway

**Configuration Limits and Capacities**  
System-Specific Capacity Limits

Trunks	System Values				
	OpenScape Business				
	X1	X3R X3W	X5R X5W	X8	S
<b>Analog Trunks</b>					
Analog Trunks	–	8 (2 x TLANI4R) 16 (2 x TLANI8)	24 (6 x TLANI4R) 48 (6 x TLANI8)	120 (15 x TMANI)	Analog trunks via gateway
<p><b>Info for OpenScape Business X3/X5/X8:</b></p> <p>A total of up to 250 IP, ISDN and analog trunks can be used.</p> <p>Examples for the maximum configuration:</p> <ul style="list-style-type: none"> <li>• OpenScape Business X3R: 2 x TLANI4R (= 8 x a/b) = 8 analog trunks + 242 IP trunks</li> <li>• OpenScape Business X3W: 2 x STLSX4 (= 8 x S<sub>0</sub>) + 2 x S<sub>0</sub> on OCCM = 20 ISDN trunks + 230 IP trunks</li> <li>• OpenScape Business X5W: 1 x TS2 (= 1 x S<sub>2M</sub>) + 5 x STLSX4 (= 20 x S<sub>0</sub>) + 2 x S<sub>0</sub> on OCCM = 74 B channels + 176 IP trunks</li> <li>• OpenScape Business X8: 3 x DIUT2 (= 6 x S<sub>2M</sub>) = 180 B channels + 70 IP trunks</li> </ul>					

**Maximum values for resources**

Resource	System Values				
	OpenScape Business				
	X1	X3R X3W	X5R X5W	X8	S
DSP channels (Gateway channels)					
<p><b>Info:</b> Connections between IP and TDM phones/trunks are "gateway connections"; each gateway connection requires one DSP channel (gateway channel).</p>					
DSP channels with the G.711 codec enabled	8 (on OCCS)	8 (on OCCMR/OCCM)	8 (on OCCMR/OCCM)	8 (on OCCL)	–
	8 (on OCCS)	48 (8 on OCCMR/OCCM + 40 on OCCB1)	48 (8 on OCCMR/OCCM + 40 on OCCB1)	128 (8 on OCCL + 120 on OCCB3)	–
DSP channels with the G.711 and G.729 codecs enabled	8 (on OCCS)	8 (on OCCMR/OCCM)	8 (on OCCMR/OCCM)	8 (on OCCL)	–
	8 (on OCCS)	40 (8 on OCCMR/OCCM + 32 on OCCB1)	40 (8 on OCCMR/OCCM + 32 on OCCB1)	104 (8 on OCCL + 96 on OCCB3)	–

Resource	System Values				
	OpenScope Business				
	X1	X3R X3W	X5R X5W	X8	S
DSP channels with the G.711 codec enabled and the SPE feature enabled	6 (on OCCS)	6 (on OCCMR/OCCM)	6 (on OCCMR/OCCM)	6 (on OCCL)	–
	6 (6 on OCCS)	38 (6 on OCCMR/OCCM + 32 on OCCB1)	38 (6 on OCCMR/OCCM + 32 on OCCB1)	102 (6 on OCCL + 96 on OCCB3)	–
DSP channels with the G.711 and G.729 codecs enabled and the SPE feature enabled	6 (on OCCS)	6 (on OCCMR/OCCM)	6 (to OCCMR/OCCM)	6 (on OCCL)	–
	6 (6 on OCCS)	31 (6 on OCCMR/OCCM + 25 on OCCB1)	31 (6 on OCCMR/OCCM + 25 on OCCB1)	81 (6 on OCCL + 75 on OCCB3)	–
T.38 channels (number of T.38 faxes to be simultaneously transmitted and received)	3 on OCCS	3 on OCCMR/OCCM	3 on OCCMR/OCCM	3 on OCCMR/OCCM	T.38 fax channels via Gateway
		6 on OCCMR/OCCM + OCCB1	6 on OCCMR/OCCM + OCCB1	6 on OCCMR/OCCM + OCCB1	
		12 on OCCMR/OCCM + OCCB3	12 on OCCMR/OCCM + OCCB3	12 on OCCMR/OCCM + OCCB3	
MEB (Media Extension Bridge) channels	30	30	30	30	60
Music on Hold (MOH)					
MOH channels (G.711, G.729)	0 to 4 (depending on configuration)	0 to 4 (depending on configuration)	0 to 4 (depending on configuration)	0 to 4 (depending on configuration)	32
PPP Channels	8	8	8	8	–
DTMF					
DTMF receiver	16	16	16	16	Per call via ITSP

## 26.2 Software Capacities

The maximum values described here are based on the software capacities of OpenScope Business.

Table: Topic: Connection to Service Provider

Topic: Connection to Service Provider	Maximum values						
	OpenScape Business					UC Booster	
	X1	X3R X3W	X5R X5W	X8	S	UC Booster Server	UC Booster Card
ITSP (Internet Telephony Service Provider) connection:							
ITSP trunks per communication system	30	60 <sup>1</sup>	60 <sup>1</sup>	60 <sup>1</sup>	180	–	–
Simultaneously activated ITSPs per communication system	8	8	8	8	8	–	–
Routes:							
Routes per communication system	16	16	16	16	16	–	–
Overflow routes per route	1	1	1	1	1	–	–

1 If > 60 trunks are required, OpenScape Business S must be used as networked ITSP gateway

Table: Topic: Stations

Topic: Station	Maximum values						
	OpenScape Business					UC Booster	
	X1	X3R X3W	X5R X5W	X8	S	UC Booster Server	UC Booster Card
Classes of Service:							
Classes of Service per communication system	15	15	15	15	15	–	–
Station number/DID number:							
Digits per station number/DID number	16 (default setting = 3)	16 (default setting = 3)	16 (default setting = 3)	16 (default setting = 3)	16 (default setting = 3)	–	–



Table: Topic: UC Smart

Topic UC Smart	Maximum values						
	OpenScape Business					UC Booster	
	X1	X3R X3W	X5R X5W	X8	S	UC Boos ter Serve r	UC Booster Card
Maximum number of licensed UC Smart users (Sum of myPortal Smart, myPortal to go, myPortal for OpenStage, Application Launcher, OpenScape Business Attendant, OpenScape Business BLF and 3rd Party WSI Clients)	30	50	50	50	250	250	150
myPortal Smart	30	50	50	50	250	250	150
Simultaneous WSI sessions	60	100	100	100	500	500	300
Call journal:							
Call journal entries per user	100	100	100	100	100	100	100
Voicemail box:							
Voicemail boxes per communication system	30	320	320	320	1500	500	320
Max. recording length per call	2 minutes	2 minutes	2 minutes	2 minutes	2 minutes	2 minutes	2 minutes
Total recording duration per communication system	32 hours	32 hours	32 hours	32 hours	32 hours	32 hours	32 hours
Messages per voicemail box	100	100	100	100	100	100	100
Simultaneous calls (incoming and outgoing)	10	10	10	10	10	10	10
Presence status:							
Status per Smart subscriber UC	9	9	9	9	9	9	9
Voicemail announcements per presence status	1	1	1	1	1	1	1
Favorites:							
Favorite entries per UC Smart user	100	100	100	100	100	100	100
Favorite groups per UC Smart user	10	10	10	10	10	10	10

**Configuration Limits and Capacities**  
Software Capacities

**Table: Topic: UC Suite**

Topic: UC Suite	Maximum values						
	OpenScope Business					UC Booster	
	X1	X3R X3W	X5R X5W	X8	S	UC Booster Server	UC Booster Card
Maximum number of simultaneously active UC Suite clients  (Sum of myPortal for Desktop, myPortal for Outlook, myPortal for OpenStage, Application Launcher, myAttendant, myAgent)	–	–	–	–	1500	500	150
myPortal for Desktop	–	–	–	–	1500	500	150
myPortal for Outlook	–	–	–	–	1500	500	150
myAttendant	–	–	–	–	20	20	20
Call journal (myPortal for Desktop and myPortal for Outlook):							
Archiving duration in the UC clients	–	–	–	–	30 days (default setting = 30 days)		
Archiving duration in the communication system	–	–	–	–	365 days (default setting = 30 days)		
Call journal entries	–	–	–	–	Unrestricted		
Recording calls/conferences: <sup>1</sup>							
Recording length per call/conference	–	–	–	–	Limited by the length of the call/conference		
Application-controlled conferences:							
Simultaneous UC conferences per communication system	–	–	–	–	10	5	5
Participants per conference	–	–	–	–	18	16	16
External participants per conference	–	–	–	–	15	15	15
Conference channels	–	–	–	–	40 for Meet-Me and Ad Hoc	20 for Meet-Me and Ad Hoc	20 for Meet-Me and Ad Hoc
External database connectivity (LDAP, SQL, etc.):							
External database connections per communication system	–	–	–	–	10	10	10
LDAP connection of the system telephones	See the operating instructions of the system telephones					–	–
LDAP usage via UC clients (myAttendant, myPortal for Desktop, etc.)	–	–	–	–	Every client can use the central LDAP connection of the communication system		
SQL usage via UC clients (myAttendant, myPortal for Desktop, etc.)	–	–	–	–	Every client can use the central SQL connection of the communication system		

Topic: UC Suite	Maximum values						
	OpenScape Business					UC Booster	
	X1	X3R X3W	X5R X5W	X8	S	UC Booster Server	UC Booster Card
Voicemail box: <sup>1</sup>							
Voicemail boxes per communication system	–	–	–	–	1500	500	150
Recording length	–	–	–	–	15 minutes per call (1 minute of voice corresponds to approx. 1 MB of storage space)		
Recording length up to which voicemail messages can be forwarded by email	–	–	–	–	Approx. 10 minutes		
Simultaneous calls (incoming and outgoing)	–	–	–	–	30	30	30
Fax box: <sup>1</sup>							
Fax boxes per communication system	–	–	–	–	1500	500	150
Fax length in pages	–	–	–	–	500 (1 standard fax (2 DIN A4 pages) corresponds to approx. 48 KB of storage space)		
Faxes to be simultaneously sent and received	–	–	–	–	8	8	8
Merge fax recipients	–	–	–	–	Unrestricted		
Fax box groups per communication system	–	–	–	–	60	60	60
Stations per fax box group	–	–	–	–	10	10	10
Announcements: <sup>1</sup>							
Announcements per UC Suite subscriber	–	–	–	–	1 greeting announcement, 1 name announcement, 1 presence status based announcement and 1 announcement for the personal AutoAttendant		
Presence status:							
Status per UC Suite subscriber	–	–	–	–	9	9	9
Voicemail announcements per presence status	–	–	–	–	1	1	1
Multi-user chat:							
Internal communication partner	–	–	–	–	Unrestricted		
External XMPP communication partner	–	–	–	–	1	1	1

**Configuration Limits and Capacities**  
Software Capacities

Topic: UC Suite	Maximum values						
	OpenScope Business					UC Booster	
	X1	X3R X3W	X5R X5W	X8	S	UC Booster Server	UC Booster Card
AutoAttendant:							
Personal AutoAttendant	–	–	–	–	20	20	20
Company AutoAttendant	–	–	–	–	1	1	1

1 The total recording duration for voice announcements, voicemails, recorded voice calls and faxes depends on the hard disk capacity in the communication system. There are no individual limits per subscriber.  
Example for a 160 GB hard drive: the storage volume of the partition for recording voice announcements, voicemails, voice calls and faxes is 20 GB. This corresponds to a total recording time of about 20000 minutes.

**Table: Topic: Functions at the Telephone**

Topic: Functions at the Telephone	Maximum values						
	OpenScope Business					UC Booster	
	X1	X3R X3W	X5R X5W	X8	S	UC Booster Server	UC Booster Card
Caller list:							
Caller lists per communication system	650	650	650	650	1300	–	–
Entries per caller list	10	10	10	10	10	–	–
Saved digits per entry	25-digit phone number and seizure code					–	–
Direct station select keys (DSS keys):							
Key modules per communication system	30	250	250	250	250	–	–
Key modules per telephone	2	2	2	2	2	–	–
Keys per key module	12 for OpenStage Key Module 18 for OpenStage Key Module 15					–	–
Busy Lamp Fields (BLF) per communication system	12	12	12	12	12	–	–
Keys per Busy Lamp Field	90	90	90	90	90	–	–
Individual Speed Dialing (ISD):							
Entries in the KWI pool per communication system	2000	2000	2000	2000	2000	–	–
Entries per station	10	10	10	10	10	–	–
Digits per entry	25-digit phone number and seizure code					–	–
System Speed Dialing (SSD):							
Entries per communication system	8000	8000	8000	8000	8000	–	–
Character length of name	16	16	16	16	16	–	–
Digits per entry	25-digit phone number and seizure code					–	–
Redialing:							

<b>Topic: Functions at the Telephone</b>	<b>Maximum values</b>						
	<b>OpenScape Business</b>					<b>UC Booster</b>	
	<b>X1</b>	<b>X3R</b> <b>X3W</b>	<b>X5R</b> <b>X5W</b>	<b>X8</b>	<b>S</b>	<b>UC Booster Server</b>	<b>UC Booster Card</b>
Entries per telephone with display	3 for optiPoint 410/420 and OpenStage 20E/20/20G/40/40G  10 for OpenStage 15  In the OpenStage 60/60G/80/80G, a max. of 30 entries each can be used for the "Answered", "Missed" and "Dialed" call lists					–	–
Entries per telephone without display	1	1	1	1	1	–	–
Saved digits per entry	25-digit phone number and seizure code					–	–
<b>Call waiting/call waiting tone</b>							
Waiting callers per telephone	16	16	16	16	16	–	–
<b>Parking:</b>							
Park positions per communication system	10	10	10	10	10	–	–
<b>Callback calls:</b>							
Callback entries per telephone	5	5	5	5	5	–	–
<b>Advisory messages/Message texts:</b>							
Advisory messages per communication system	250	250	250	250	250	–	–
Message texts per communication system	150	150	150	150	150	–	–
Configurable advisory messages + message texts per communication system	10 + 10	10 + 10	10 + 10	10 + 10	10 + 10	–	–
Character length of a configurable advisory message/message text	24	24	24	24	24	–	–
Received advisory messages/message texts per telephone with display	5	5	5	5	5	–	–
Received advisory messages/message texts per telephone without display	1	1	1	1	1	–	–
<b>Ringing group on:</b>							
Stations included	5	5	5	5	5	–	–
<b>Call Forwarding (CF):</b>							
FWD destinations per telephone	4	4	4	4	4	–	–
Digits per external CFW destination	25-digit phone number and seizure code					–	–
Chained FWD destinations					5	–	–
<b>System-controlled conferences:</b>							

**Configuration Limits and Capacities**  
Software Capacities

Topic: Functions at the Telephone		Maximum values						
		OpenScope Business				UC Booster		
		X1	X3R X3W	X5R X5W	X8	S	UC Booster Server	UC Booster Card
Simultaneous system conferences per communication system		10	10	10	10	8	–	–
Participants per conference		8	8	8	8	9	–	–
External participants per conference		7	7	7	7	7	–	–
Conference channels		32	32	32	32	40	–	–
Entrance Telephone/Door Opener:								
Connections via a/b interfaces per communication system		4	4	4	4	–	–	–
Digits per code entry		5	5	5	5	–	–	–
Trunk queuing:								
Simultaneous entries per communication system		32	32	32	32	–	–	–

**Table: Topic: Working in a Team (Groups)**

Topic: Working in a Team (Groups)		Maximum values						
		OpenScope Business				UC Booster		
		X1	X3R X3W	X5R X5W	X8	S	UC Booster Server	UC Booster Card
Call pickup groups:								
Call pickup groups per communication system		32	32	32	32	120	–	–
Stations per call pickup group		32	32	32	32	32	–	–
Group calls, hunt groups, Basic MULAPs, Executive MULAPs, Team groups, Top groups and voicemail groups:								
Total of group calls, hunt groups, Basic MULAPs, Executive MULAPs and voicemail groups per communication system		800	800	800	800	800	–	–
Total number of Team groups and Top groups per communication system		500	500	500	500	500	–	–
Subscribers per group call, hunt group, Basic MULAP		20	20	20	20	20	–	–
Subscribers per Executive MULAP, Team group, Top group		10	10	10	10	10	–	–
Stations per voicemail group		20	20	20	20	20	–	–
MULAP keys per telephone		10	10	10	10	10	–	–
Fax box groups:								

Topic: Working in a Team (Groups)	Maximum values						
	OpenScope Business					UC Booster	
	X1	X3R X3W	X5R X5W	X8	S	UC Booster Server	UC Booster Card
Fax box groups per communication system: see <a href="#">Table: Topic: UC Suite</a>							
Internal paging:							
Simultaneous announcements per communication system	1	1	1	1	6	–	–
Recipients of the announcement	20	20	20	20	20	–	–
UCD groups:							
UCD groups per communication system	60	60	60	60	60	–	–
Announcements per UCD group	7	7	7	7	7	–	–
Priority levels per UCD group	10	10	10	10	10	–	–
Queued calls per UCD group	30	30	30	30	30	–	–
UCD agents:							
UCD agent IDs per communication system	330	330	330	330	330	–	–
Simultaneously active UCD agents per communication system	64	64	64	64	64	–	–
Announcements for UCD:							
Number of callers, per communication system, for whom an announcement can be simultaneously played	8	8	8	8	8	–	–

Table: Topic: Call Routing

Topic: Call Routing	Maximum values						
	OpenScope Business					UC Booster	
	X1	X3R X3W	X5R X5W	X8	S	UC Booster Server	UC Booster Card
Toll restriction:							
Allowed lists	6	6	6	6	6	–	–
Denied lists	6	6	6	6	6	–	–
Allowed list, short (10 entries)	5	5	5	5	5	–	–
Allowed list, long (100 entries)	1	1	1	1	1	–	–
Short Denied list (10 entries)	5	5	5	5	5	–	–
Long Denied list (50 entries)	1	1	1	1	1	–	–
Number of characters in list entries	32	32	32	32	25	–	–
Least Cost Routing LCR):							

**Configuration Limits and Capacities**  
Software Capacities

Topic: Call Routing		Maximum values						
		OpenScope Business					UC Booster	
		X1	X3R X3W	X5R X5W	X8	S	UC Booster Server	UC Booster Card
Dialed/Verified digits	24	24	24	24	24	–	–	
Dial Plans	1000	1000	1000	1000	1000	–	–	
Route tables	254	254	254	254	254	–	–	
Routes per routing table	16	16	16	16	16	–	–	
Dial rules per route	254	254	254	254	254	–	–	
Digits per dial rule	40	40	40	40	40	–	–	
Night service:								
Authorized stations per communication system	5	5	5	5	5	–	–	
E911 Emergency Call Service (for the U.S. only):								
Digits per LIN (Location Identification Number)	16	16	16	16	16	–	–	
Hotline after Timeout/Hotline:								
Hotline destinations per communication system	6	6	6	6	6	–	–	
CON groups:								
CON groups per communication system	64	64	64	64	64	–	–	

**Table: Topic: Attendants**

Topic: Attendants		Maximum values						
		OpenScope Business					UC Booster	
		X1	X3R X3W	X5R X5W	X8	S	UC Booster Server	UC Booster Card
myAttendant: see <a href="#">Table: Topic: UC Suite</a>								
AutoAttendant (UC Smart): see <a href="#">Table: Topic: UC Smart</a>								
AutoAttendant (UC Suite): see <a href="#">Table: Topic: UC Suite</a>								
AutoAttendant (Xpressions Compact):								
Personal AutoAttendant	–	30 with IVMP4R / 100 with IVMS8NR  30 with IVMP4 / 100 with IVMS8N	100 with IVMNL	–	–	–	–	



Topic: Attendants	Maximum values						
	OpenScope Business					UC Booster	
	X1	X3R X3W	X5R X5W	X8	S	UC Booster Server	UC Booster Card
OpenScope Business Attendant:							
OpenScope Business Attendants per communication system	8	8	8	8	8	8	–
OpenScope Business BLF per communication system	30	50	50	50	250	250	150

Table: Topic: Multimedia Contact Center

Topic: Multimedia Contact Center	Maximum values						
	OpenScope Business					UC Booster	
	X1	X3R X3W	X5R X5W	X8	S	UC Booster Server	UC Booster Card
myAgent:							
Licensable agents	–	–	–	–	192	192	192
Simultaneously active agents	–	–	–	–	64	64	64
myReports	–	–	–	–	1	1	1
Queues:							
Queues per communication system	–	–	–	–	50	50	50
Wrap up:							
Wrap up codes per queue	–	–	–	–	Unrestricted	Unrestricted	Unrestricted

Table: Topic: Mobility

Topic: Mobility	Maximum values						
	OpenScope Business					UC Booster	
	X1	X3R X3W	X5R X5W	X8	S	UC Booster Server	UC Booster Card
Teleworker workplaces:							
Teleworker workplaces via VPN per communication system	10	10	10	10	Possible via external router	–	–
Mobility Stations:							

**Configuration Limits and Capacities**  
Software Capacities

Topic: Mobility		Maximum values					
		OpenScape Business				UC Booster	
		X1	X3R X3W	X5R X5W	X8	S	UC Booster Server
Mobility Entry: stations per communication system	30	150	150	150	250	250	150
myPortal to go (UC Smart): stations per communication system	30	50	50	50	250	250	150
myPortal to go (UC Suite): stations per communication system	–	–	–	–	250	250	100

**Table: Topic: Security**

Topic: Security		Maximum values					
		OpenScape Business				UC Booster	
		X1	X3R X3W	X5R X5W	X8	S	UC Booster Server
VPN:							
VPN tunnel	256	256	256	256	Possible via external VPN router	–	–
VPN rules	634	634	634	634		–	–
Individual lock code:							
Digits per phone lock code	5	5	5	5	5	–	–
Permitted characters	0 through 9	0 through 9	0 through 9	0 through 9	0 through 9	–	–

**Table: Topic: Networking OpenScape Business**

Topic: Networking OpenScape Business <sup>1</sup>		Maximum values	
Networking OpenScape Business X3R/X3W, OpenScape Business X5R/X5W, OpenScape Business X8, OpenScape Business S and OpenScape Business UC Booster Server:			
Networked communication systems (nodes)	8 (with UC Suite) / 32 (without UC Suite)		
Stations in the network	1000		

<sup>1</sup> Project-specific releases can be requested for networking requirements beyond the configuration limits listed here. Please also refer to the current Sales Release.

Table: Topic: Auxiliary Equipment

Topic: Auxiliary Equipment	Maximum values						
	OpenScope Business					UC Booster	
	X1	X3R X3W	X5R X5W	X8	S	UC Booster Server	UC Booster Card
OpenStage Gate View:							
Cameras per communication system	–	–	–	–	8 (license-dependent)	8 (license-dependent)	2 (license-dependent)
Telephones (OpenStage HFA 60, 60 G, 80, 80 G, 80 E) displaying the camera image of the communication system	–	10 (with OCAB) 20 (with Application Server)			20	–	–
iPhone apps or web clients to display the camera image per communication system	–	10 (with OCAB) 20 (with Application Server)			20	–	–

Table: Topic: Application Connectivity

Topic: Application Connectivity	Maximum values						
	OpenScope Business					UC Booster	
	X1	X3R X3W	X5R X5W	X8	S	UC Booster Server	UC Booster Card
CSTA:							
CSTA links via CSP per communication system	–	–	–	–	4	4	4
Monitor points for trunks or stations	–	–	–	–	700	700	700
TAPI 170 middleware server	–	–	–	–	1	1	1
Web Services Interface Protocol:							
Web Server WebSessions	100	100	100	100	200	100	100
Internal Monitor Points	800	800	800	800	800	800	800

Table: Topic: Accounting

Topic: Accounting	Maximum values						
	OpenScope Business					UC Booster	
	X1	X3R X3W	X5R X5W	X8	S	UC Booster Server	UC Booster Card
Call Detail Recording Central:							
Entries in the call data buffer per communication system	20000	20000	20000	20000	20000	–	–
Account Code (ACCT):							

**Configuration Limits and Capacities**  
Software Capacities

Topic: Accounting		Maximum values					
		OpenScape Business				UC Booster	
		X1	X3R X3W	X5R X5W	X8	S	UC Boos ter Serve r
Account code entries per communication system	1000	1000	1000	1000	1000	–	–
Verifiable digits per Acc. code	11	11	11	11	11	–	–
Permitted characters	0 through 9	0 through 9	0 through 9	0 through 9	0 through 9	–	–

# 27 Expert mode

**Expert mode** provides menus and functions to configure and maintain the system.

## 27.1 Display Conventions for Parameter Descriptions

The parameter descriptions follow the structure of the Expert mode in the WBM.

Menu Item	Each menu item in the Expert mode is associated with a (context-sensitive) help topic that you can call up directly from within the WBM. The title of the Help topics displays the path of the WBM window.  Example:  <b>Basic Settings &gt; System &gt; System Flags</b>
Tab	Each tab has a separate parameter table in the help topic associated with it. The same parameters of different tabs are described in the same parameter table. About each parameter table is a list of the tab(s) for which the parameters are valid.  Example: <ul style="list-style-type: none"><li>• <b>Add Static IP Address</b></li><li>• <b>Edit Static IP Address</b></li><li>• <b>Delete Static IP Address</b></li></ul>
Area	If the WBM windows are organized into areas, you will find this structure reflected in the parameter table as well. The parameter table will then contain a subheading for each area, followed by the parameters of this area.
Parameters	Parameters are described in a two-column parameter table. The left column contains the parameter names. The right column describes the parameters. Self-explanatory parameters are mentioned, but not described. Value ranges and default values can be found at the end of the description, if any.

Parameter (optional)	Parameters that do not need to be filled are flagged with the keyword "optional".
Entry in drop-down list	Drop-down list items which are not self-explanatory are also listed as named parameters in the left column of the parameter table. The entry is separated by a colon from the name of the drop-down list.  Example: <b>Encryption Algorithms: AES</b>
Check boxes, Radio buttons and Flags	The descriptions for check boxes, radio buttons and flags always refer to the enabled state.

## 27.2 Maintenance

The functions for maintaining the communication system, e.g., for uploading Music on Hold or updating software images are grouped together under **Maintenance**.

### 27.2.1 Configuration

Under **Configuration** you will find a group of functions to load Music on Hold (MoH) or display the hardware configuration, for example.

#### 27.2.1.1 Configuration > Music on Hold (MoH) > Load to Gateway

Parameter Description of Tabs::

- **Load Music on Hold Files via HTTP**

Parameters	Description
<b>Load Music on Hold Files via HTTP</b>	
<b>MoH Day File</b>	Selection of the MoH file for day service from the local file system. File format: see note in WBM.
<b>MoH Night File</b>	Selection of the MoH file for night service from the local file system. File format: see note in WBM.
<b>Load</b>	Loads the selected MoH files into the system (requires a restart). Activation under Setup, Central Telephony > Music on Hold/Announcements.

Parameter Description of Tabs::

- **Load Audio Files via HTTP**

Parameters	Description
<b>Load Audio Files via HTTP</b>	
<b>Announcement File</b>	Select the WAV file with the announcement from the local file system. File format: see note in WBM.
<b>Already Uploaded Audio Files</b>	
<b>Wave File</b>	Displays the announcement files loaded in the communication system
<b>Delete</b>	Deletes the announcement file
<b>Load</b>	Loads the selected announcement file into the system. Activation under Setup, Central Telephony> Music on Hold/Announcements.

### 27.2.1.2 Configuration > Announcements > Load to Gateway

Parameter Description of Tabs:

- **Load Audio Files via HTTP**

Parameters	Description
<b>Load Audio Files via HTTP</b>	
<b>Announcement File</b>	Select the WAV file with the announcement from the local file system. File format: see note in WBM.
<b>Already Uploaded Audio Files</b>	
<b>Wave File</b>	Displays the announcement files loaded in the communication system
<b>Delete</b>	Deletes the announcement file
<b>Load</b>	Loads the selected announcement file into the system. Activation under Setup, Central Telephony> Music on Hold/Announcements.

### 27.2.1.3 Configuration > Port Configuration

Parameter Description of the Tab:

- **Export Configuration**

Parameters	Description
<b>Export Configuration</b>	
<b>File name</b>	Name of the exported file.
<b>Action</b>	Exports a zipped XML file (e.g., for editing in Excel) with the following data: name, phone number of the subscriber, direct inward dialing number, station type, licenses, groups, virtual stations, trunks, trunk groups, voicemail, etc.

## 27.2.1.4 Configuration > SmartVM

Parameter Description of Tabs:

- **Overview**

Parameters	Description
<b>Languages</b> Displays all languages in which the voice prompts are available. The following naming conventions exist: aabb AA = two-digit language code BB = two-digit country code The country code (bb) is usually identical to the language code (aa).	
<b>Mailbox Information</b>	
<b>Call number</b>	Displays the call number of the voicemail box
<b>Name</b>	Displays the name of the voicemail box.
<b>Messages</b>	Displays the number of new messages / total number of messages.
<b>Total Mailbox usage</b>	Displays the disk space consumption in percent.

## 27.2.1.5 Configuration > SmartVM > Mailbox Operations

Parameter Description of Tabs:

- **Execute Mailbox Operations**

Parameters	Description
<b>Reset All Mailbox configuration (delete all messages and greetings)</b>	If this flag is enabled, all greetings and messages from all voicemail boxes on the SmartVM are deleted. Default: disabled.
<b>Index</b>	Displays the index of the voicemail box.
<b>Callno</b>	Displays the call number of the voicemail box



Parameters	Description
<b>Name</b>	Displays the name of the voicemail box.
<b>Reset Passwords</b>	If this flag is enabled, the password of the voicemail box is reset to the default password 123456. The user must change the password at the next use of the voicemail box. Default: disabled.
<b>Initialize mailboxes</b>	If this flag is enabled, the following actions are performed for the selected voicemail box: Standard Mailboxes: – The password is reset – The <b>Recording</b> flag is set – Messages are deleted – Greetings are deleted – Greeting control to manual – Active greeting: Greeting 1 AutoAttendant mailboxes: – The password is reset – The <b>Intercept after announcem.</b> flag is disabled – Speed dial destinations are deleted – Greetings are deleted – Greeting control to manual – Active greeting: Greeting 1 Default: disabled.

### 27.2.1.6 Configuration > SmartVM > File Operations

Parameter Description of Tabs:

- **Backup**

Parameters	Description
<b>Backup</b>	
<b>Messages</b>	If this flag is enabled, messages from the selected voicemail boxes are backed up in addition to the greetings. Default: disabled.
<b>Available Mailboxes</b>	List of all existing voicemail boxes. You can selectively add individual or even all voicemail boxes to the list of voicemail boxes to be backed up.
<b>Mailboxes for backup</b>	List of voicemail boxes to be backed up.
<b>Buttons</b>	
<b>Apply</b>	The greetings (and messages if the <b>Messages</b> flag was enabled) of the voicemail boxes to be backed up are saved in a backup file (*.tar).

Parameter Description of Tabs:

- **Greetings**

Parameters	Description
<b>Greetings</b>	
<b>Mailbox selection</b>	Selects the voicemail box.
<b>Greeting 1 (day)</b>	Displays the greeting currently being used. <b>Standard</b> means that no customized greeting is available for the subscriber.
<b>Greeting 2 (night)</b>	Displays the greeting currently being used. <b>Standard</b> means that no customized greeting is available for the subscriber.
<b>Greeting 3</b>	Displays the greeting currently being used. <b>Standard</b> means that no customized greeting is available for the subscriber.
<b>Greeting 4</b>	Displays the greeting currently being used. <b>Standard</b> means that no customized greeting is available for the subscriber.
<b>Buttons</b>	
<b>Browse</b>	Enables navigation to the storage path of the greetings file.
<b>Load</b>	Loads a previously saved greeting or a wave file into the SmartVM. The Wave file to be loaded must have the following format:  PCM, 16 Bit, 8kHz, mono  The selected Wave file is converted on loading. Depending on the size of the wave file, this may take some time to complete.
<b>backup</b>	The currently used greeting is backed up on the PC. The greeting is saved on the PC in binary format (vma file) and can therefore not be played back or edited.
<b>Delete</b>	The currently used greeting is deleted from the SmartVM.

Parameter Description of Tabs:

- **Restore**

Parameters	Description
<b>Restore</b>	
<b>Messages</b>	Overwrites not only the greetings of the selected mailboxes, but also the messages. Default: disabled.
<b>Override</b>	If this flag is disabled, only the greetings of the selected voicemail boxes that are present in the backup data will be overwritten. If the <b>Messages</b> flag is also enabled, the messages contained in the backup data are included as well. Existing messages are retained.  If this flag is enabled, all the greetings and messages of the selected voicemail boxes in the SmartVM will be deleted before the restore. If voicemail boxes which are not contained in the backup data are selected, these will also be deleted! The greetings contained in the backup data are transferred. If the <b>Messages</b> flag is also enabled, the messages contained in the backup data are transferred as well.  Default: disabled.

Parameters	Description
<b>Available mailboxes</b>	List of all existing voicemail boxes in the backup file. You can selectively add individual or even all voicemail boxes to the list of voicemail boxes to be restored.
<b>Mailboxes for backup</b>	List of voicemail boxes to be restored.
<b>Buttons</b>	
<b>Browse</b>	Enables navigation to the storage path of the backup file.
<b>Load</b>	The voicemail boxes contained in the backup file are displayed.  On clicking the button again, the greetings and messages of the selected voicemail boxes are restored.

### 27.2.1.7 Configuration > Branding

Parameter Description of the Tab:

- **Branding**

Parameters	Description
<b>Branding</b>	Selects the product name.

### 27.2.1.8 Configuration > IP Gateway Address

Parameter Description of the Tab:

- **Change IP gateway address**

Parameters	Description
<b>Change IP gateway address</b>	
<b>Gateway IP address</b>	Entry of the IP address of the communication system, e.g., 192.168.1.2

## 27.2.2 Software Image

The functions for refreshing the gateway software and the phone images are grouped together under **Software Image**.

### 27.2.2.1 Software Image > System Software > Update via Internet

Parameter Description of Tabs::

- **Load Software Images from Web Server**

Parameters	Description
<b>Web Server Settings</b>	
<b>Software Image URL</b>	Display and edit the link to the software server, including the path to the image file.
<b>User name</b>	User name for logging into the software server.
<b>Password</b>	Password for logging into the software server.
<b>Software Update Information</b>	Activation of the check to determine whether a new software version has been provided on the software server.
<b>Start Time</b>	Time of the check. Value range: 00.00 to 24.00, default value: 02.00
<b>Use Proxy</b>	Proxy activation, if a proxy is used.
<b>HTTP Proxy</b>	
<b>HTTP Proxy</b>	Input of the link to the proxy server.
<b>HTTP Proxy Port</b>	Input of the port of the proxy server. Default value: 80
<b>User name</b>	User name for logging into the proxy server.
<b>Password</b>	Password for logging into the proxy server.
<b>Last Software Update on</b>	Displays when the last software update was performed.
<b>Buttons</b>	
<b>Default</b>	Resets edited values back to the default values.

### 27.2.2.2 Software Image > System Software > Update via File Upload

Parameter Description of Tabs::

- **Load Software Images via File Upload**

Parameters	Description
<b>Remote File Name (PC File System)</b>	Navigate to the storage location of the image file.
<b>Software Activation</b>	
<b>Start action immediately after transfer</b>	The software is immediately transferred to the communication system in the background. After two restarts, the software is up-to-date.
<b>Start Action in</b>	The software is immediately transferred to the communication system in the background. After the specified period, the software is activated. Input of the time period in days, hours and minutes.

Parameters	Description
<b>Start Action on</b>	The software is immediately transferred to the communication system in the background. The software is activated at the specified time. Input of the time as the date and time.
<b>Local System Time</b>	Displays the date and time of the system.
<b>Software version of the currently used system software images</b>	Displays the software version of the current image file.

### 27.2.2.3 Software Image > System Software > Update via USB Stick

Parameter Description of Tabs::

- **Load Software Images from USB Stick**

Parameters	Description
<b>List of all existing compatible image files</b>	
<b>Version</b>	Displays the version number of the image files found on the USB device.
<b>Load</b>	Selection of the image file found on the USB device to be used for the software update.
<b>File name</b>	Displays the file names of the image files found on the USB device.
<b>Size of Image (MB)</b>	Displays the file size of the image files found on the USB device.
<b>Software Activation</b>	
<b>Start action immediately after transfer</b>	The software is transferred immediately to the communication system in the background and activated. System operations are temporarily interrupted for the activation.
<b>Start Action in</b>	The software is immediately transferred to the communication system in the background. After the specified period, the software is activated. Input of the time period in days, hours and minutes.
<b>Start Action on</b>	The software is immediately transferred to the communication system in the background. The software is activated at the specified time. Input of the time with the date and time.
<b>Local System Time</b>	Displays the date and time of the system.
<b>Software version of the currently used system software images</b>	Displays the current software version.

### 27.2.2.4 Software Image > Phone Images > Load

Parameter Description of Tabs:

- **Load Phone Software**

Parameters	Description
Remote File Name (PC File System)	Selection of the phone software (image file)
<b>Currently installed images</b>	
Delete	The phone images are marked for deletion.
File name	Displays the file name of the image file.
Device type	Displays the system telephone type associated with the image file.
Version	Displays the version of the image file.
<b>Buttons</b>	
Load	The specified phone image is loaded into the communication system.
Delete	The selected phone images are deleted from the communication system.

### 27.2.2.5 Software Image > Phone Images > Deploy

Parameter Description of Tabs:

- **Deployment of phone software**

Parameters	Description
<b>Currently installed images</b>	
Deploy	If this check box is selected, the phone software is transmitted to all connected system telephones of the telephone type.
File name	Displays the file name of the image file.
Device type	Displays the system telephone type associated with the image file.
Version	Displays the version of the image file.
Type	Type of the system telephone.
Standard	Any phone software flagged as the default will be automatically transferred to any system telephone associated with this type whenever that phone logs into the system for the first time.

### 27.2.2.6 Software Image > Phone Images > Deploy to device

Parameter Description of Tabs:

- **Deployment of phone software per device**

Parameters	Description
<b>Currently installed images</b>	
Call no	Phone number of the system telephone.
Device type	Type of the system telephone.

Parameters	Description
IP Address	IP address of the system telephone; direct link to the WBM of the system telephone.
MAC Address	MAC address of the system telephone.
Current SW version	Current software version of the system telephone.
Deployable software	Selection of the phone image to be transmitted to the system telephone.

### 27.2.2.7 Software Image > Phone Logo Images > Load

An image (e.g., a company logo) can be loaded onto the display of the system telephones (OpenStage 40/60/80 or Telekom variants); displayed in the idle state (on-hook). For details on the specification of the logo file, see [Telephone Logos](#).

Parameter Description of Tabs:

- **Loading the Phone logo**

Parameters	Description
Remote File Name (PC File System)	Selection of the file with the phone logo.
<b>Currently Installed Logo Images</b>	
Delete	The phone logo files are marked for deletion.
File name	Displays the file name of the telephone logo file.
<b>Buttons</b>	
Load	The specified phone logo file is loaded into the communication system.
Delete	The selected phone logo files are deleted from the communication system.

### 27.2.2.8 Software Image > Phone Logo Images > Deploy

An image (e.g., a company logo) can be loaded onto the display of the system telephones (OpenStage 40/60/80 or Telekom variants); displayed in the idle state (on-hook). For details on the specification of the logo file, see [Telephone Logos](#).

Parameter Description of Tabs:

- **Deployment of phone logos**

Parameters	Description
<b>Currently Installed Logo Images</b>	
Deploy	If the check box is selected, this phone logo file will be transmitted to the selected system telephones.
File name	Displays the file name of the telephone logo file.
Deploy to Workpoints with Selected Device Type	Selection to determine whether the phone logo is to be sent to all system telephones or only to a specific type of system telephone.

## 27.2.3 Cordless

Functions for all configured base stations are grouped together under **Cordless**.

### 27.2.3.1 Cordless > Base Stations

Parameter Description of Tabs:

- **Base station status**

Parameters	Description
<b>Base station data</b>	
<b>BS Frequency</b>	The frequencies of the selected base station is displayed here. Up to 10 different frequency channels can be selected simultaneously (see table below).
<b>Base station</b>	Number of the base station.
<b>SW Version</b>	Software version of the base station.
<b>HW version</b>	Hardware version of the base station.
<b>Status</b>	State of the associated port: port active Port not connected Port blocked Port connected, inactive Port connected, inactive 1st expansion port for ... (no. of main port) 2nd. expansion port for ... (no. of main port)
<b>Overload</b>	Number of the overload situations on the UP0/E interface.
<b>Restart</b>	Number of times the base station was restarted.
<b>L1/L2 Error</b>	Number of L1/L2 errors that occurred in the base station.
<b>Abnormal Release</b>	Number of interrupted calls in the base station.
<b>Calls by BS</b>	Number of calls made via the base station (both incoming and outgoing).
<b>Hopping Mode</b>	Cordless Version 2 systems always operate in fast hopping mode, i.e., all frequency - time slot pairs can be used. This provides for 120 duplex channels. In the case of base stations with slow hopping, only every second frequency - time slot pair can be used. This means than only 60 duplex channels are available. All cordless version 1 systems operate in slow hopping mode.
<b>BHO Count OK</b>	Number of successfully completed intracell handovers (bearer handovers BHO), i.e., successful transfer of the carrier frequency and/or the time slot within a radio cell. Not supported by Hicom cordless EM V2.1 and V2.2. Although the meter is not supported, the Bearer Handover feature is available.
<b>BHO Count not OK</b>	Number of intracell handovers that failed (bearer handovers BHO). Not supported by Hicom cordless EM V2.1 and V2.2. Although the meter is not supported, the Bearer Handover feature is available.



Parameters	Description
<b>Intra SLC Handover</b>	Number of handover procedures within the SLC16 card. This is counted in the new base station.
<b>Inter SLC handover</b>	Number of handover procedures between SLC16 cards. This is counted in the new base station.
<b>SLC16-wide</b>	
<b>Lost Calls</b>	Number of calls that could not be processed due to a lack of resources.
<b>SLMC Overload</b>	Number of overload situations on the SLC16 board. The number of free pool elements on the SLC16 board falls below a minimum value. All incoming connections will be rejected by the SLC16 IWU until the overload situation returns to normal.
<b>LR Roam</b>	LR Roam counts each connection for a mobile telephone with a default PMID and located at a different SLC. Number of locate request messages that reported roaming (i.e., the current location of the mobile telephone has changed). Each time the mobile phone is switched on, a locate request is executed. If the mobile phone is switched off and switched on again in another radio cell, this meter does not execute a count.
<b>LR Async</b>	LR Async counts each connection for a mobile telephone with a default PMID where the current location SLC is unchanged. This refers to the number of locate request messages which reported layer asynchronicity (i.e., the current location of the mobile phone is unchanged). The count is always performed for the home SLC, and only if a connection is actually set up or supports the CHO with the default PMID. In addition, the criteria for a location update must be met for each connection, i.e., a LOCATE request has been received or the security procedures, authentication (and coding) have been implemented for the link.
<b>HDLC Error</b>	Number of uncritical HDLC error messages that were not reported to the communication system (overflow, underrun, CRC error).
<b>CMI Version</b>	The current cordless version is displayed here.

Frequency (channel)	DECT	Europe 1880 – 1900 MHz	Latin America 1910 – 1930 MHz
10	9	1881,792 MHz	1911,16 MHz
9	8	1883,520 MHz	1912,896 MHz
8	7	1885,24 MHz	1914,624 MHz
7	6	1886,976 MHz	1916,352 MHz
6	5	1888,704 MHz	1918,080 MHz
5	4	1890,432 MHz	1919,80 MHz
4	3	1892,160 MHz	1921,536 MHz
3	2	1893,88 MHz	1923,264 MHz
2	1	1895,616 MHz	1924,992 MHz
1	0	1897,344 MHz	1926,720 MHz

## 27.2.4 Port/Board Status

The status of all boards can be displayed. In addition, the boards and their ports can be released and locked.

### 27.2.4.1 Port/Board Status > Board Status

Parameter Description of Tabs:

- **Board Status**

Parameters	Description
<b>Slot</b>	Physical slot number.
<b>Board</b>	Board designation.
<b>Not plugged</b>	Checked if the board is not inserted.
<b>Faulty</b>	Checked if the board is not defective (not charged). It is also possible that a defective or unconfigured board is not displayed.
<b>Is Locked</b>	Checked if at least one port of this board is locked.
<b>Free</b>	Checked if all ports of this board are free.
<b>Res.</b>	Checked if at least one station or line of this board has picked up a call, is being called or is currently being used for an active call.
<b>Clock ref.</b>	Checked if the board provides the reference clock.
<b>Buttons</b>	
<b>Start</b>	Starts the update of the display. The status is updated every 3 seconds.
<b>Stop</b>	Stops the update of the display.

### 27.2.4.2 Port / Board Status > Out of Service

Parameter Description of Tabs:

- **Port out of Service**
- **Board out of Service**

Parameters	Description
<b>Access</b>	Slot and port at which the station or line is connected.
<b>Call no.</b>	Call number assigned to the port.
<b>Name</b>	Name assigned to the station or line.

Parameters	Description
<b>Status</b>	Depending on whether or not an allowed station or allowed line is connected to the port, the ports may be <b>active</b> or <b>inactive</b> . Ports may also be in the <b>In Service</b> (default) or <b>Not in Service through Tool</b> status, i.e., if they were locked via <b>Lock card</b> .  The <b>In Service</b> status is not identical with <b>active</b> . The port status could be <b>active, In Service</b> , for example, or even <b>inactive, In Service</b> .
<b>Buttons</b>	
<b>Lock Selection</b>	The selected ports are locked.  On locking U <sub>P0/E</sub> ports, the associated physical port is always taken out of service. Consequently, on selecting a master port, the corresponding slave port is also taken out of service.
<b>Release selection</b>	The selected ports are released.
<b>Lock card</b>	The selected boards and their ports are locked.  On locking individual mobile phones of a Cordless board, the entire board and thus all mobile phones are always locked. The locking of individual mobile phones is achieved by changing the PIN of the mobile phones.
<b>Release card</b>	The selected boards and their ports are released.

## 27.2.5 Traces

Trace functions are grouped together under **Traces**. The administrator can start and stop traces and change the trace settings.

### 27.2.5.1 Traces > Trace Format Configuration

The Trace Format Configuration can be used to define which header data is to be included in the trace output and how the trace data is to be formatted.

Parameter Description of Tabs:

- **Edit Trace Configuration**

Parameters	Description
<b>Data Included in the Trace Header Output</b>	
<b>Global Trace Header Format Settings</b>	When this flag is activated, the options for the following header data can be activated or deactivated.  Default value: Enabled
<b>Subsystem ID</b>	When this flag is activated, the subsystem ID is included in the trace output.  Default value: Enabled
<b>Task Name</b>	When this flag is activated, the task name is included in the trace output.  Default value: Enabled

Parameters	Description
<b>Task ID</b>	When this flag is activated, the task ID is included in the trace output. Default value: Enabled
<b>Time</b>	When this flag is activated, the specified time is included in the trace output. Default value: Enabled
<b>Module Name</b>	When this flag is activated, the module name is included in the trace output. Default value: Enabled
<b>Line Number</b>	When this flag is activated, the line number is included in the trace output. Default value: Enabled
<b>Formatting of the Trace Data</b>	
<b>Full formatting with Parameter Expansion</b>	Standard output mode: All data types are expanded. Trace output: Normal (suitable for normal operation) Default value: Enabled
<b>Limited Formatting (Message types binary, special XTracer format)</b>	In this restricted output mode, the data types are shown in binary format, i.e., as present at the time of the trace. The binary format is intended for analysis with the X-Tracer tool. Trace output: Fast (suitable for medium to high load) Default value: Disabled
<b>Limited Formatting (only basic data types)</b>	In this output mode, only elementary data types (e.g., integer, short, long, string) will be expanded. Trace output: Very fast (suitable for high load) Default value: Disabled
<b>Performance optimized Trace without Parameter Expansion</b>	In this output mode, data type expansion is disabled. Thus, there is also no overhead for trace formatting. Trace output: Extremely fast (suitable for very high load) Default value: Disabled

### 27.2.5.2 Traces > Trace Output Interfaces

Parameter Description of Tabs:

- **Edit Trace Output Interfaces**

Parameters	Description
<b>File Trace</b>	
<b>Switch File Trace On</b>	When this flag is activated, trace messages in the communication system are written to a log file. Default value: Enabled
<b>Maximum Trace Quota (Kbytes)</b>	Displays the maximum size of the trace memory in kilobytes

Parameters	Description
<b>Policy to handle reach of max. quota</b>	Option to select what should occur on reaching the maximum trace quota.
<b>Policy to handle reach of max. quota: Wrap Around (remove oldest trace file)</b>	Whenever the maximum trace quota is reached, the oldest respective trace log file is overwritten. Default value: Enabled
<b>Policy to handle reach of max. quota: Stop temporarily the File Trace</b>	On reaching the maximum trace quota, the trace file output is stopped. Default value: Disabled
<b>Time between creation of new trace files (sec)</b>	Displays the time in seconds after which a new trace log file is created.
<b>Time range, for which trace files are available</b>	Displays the time range for which trace log files are available.
<b>Trace via LAN (XTracer)</b>	
<b>Switch Trace via LAN On (XTracer)</b>	Trace messages are transmitted via the LAN interface. Default value: Disabled
<b>Timer Value (sec)</b>	Displays the time in seconds after which trace data is transmitted.

### 27.2.5.3 Traces > Trace Log

Parameter Description of Tabs:

- **Load via HTTP**
- **Clear Trace Log**

---

**INFO:** The deletion of trace log data cannot be undone.

---

Parameters	Description
<b>Trace Log</b>	
<b>Complete Trace Log</b>	All existing trace log files are downloaded
<b>Log from Today</b>	The trace log files of the current day (as of 00:00 hours) are downloaded.
<b>Own Selection</b>	Trace log files of the selected time period are downloaded.

### 27.2.5.4 Traces > Digital Loopback

They can only be configured using E Manager.

Digital loopbacks are used to test the B channels of S<sub>0</sub>, S<sub>2M</sub> and T1 interfaces of any existing boards. Digital loopbacks should only be activated if requested by the service provider.

Parameter Description of Tabs:

- **Edit Digital Loopback**

### 27.2.5.5 Traces > Customer Trace Log

This function can be used to start the event display (customer trace). Message types include System, SIP, STUN and LDAP.

Parameter Description of Tabs:

- **Display**
- **Load via HTTP**
- **Clear Trace Log**

Parameters	Description
<b>auto refresh</b>	When this flag is activated, the display for the customer trace log is refreshed automatically. Default value: Enabled
<b>Seconds until next automatic refresh</b>	Time in seconds after which the customer trace log is refreshed automatically.

### 27.2.5.6 Traces > M5T Trace Components

This function is used to monitor the SIP stack.

Changes to the settings should only be made if requested by the responsible Service Support.

Parameter Description of Tabs:

- **Edit M5T Trace Components**
- **Start/Stop Trace Component**

Parameters	Description
<b>Package Name</b>	Name of the M5T trace component
<b>Trace level</b>	Level of detail for the recording of the MST trace component (trace level 0 = lowest level of detail to trace level 9 = maximum level of detail) Default value: 0
<b>Trace On</b>	When this flag is activated, the MST trace component data is recorded. Default value: Disabled
<b>Crotch</b>	Increment of the activation

### 27.2.5.7 Traces > Secure Trace

This function is used to record encrypted VoIP payload and signaling data streams.

The recording of encrypted connection data is subject to the mandatory approval of the customer and may only be performed in coordination with the responsible Service Support. For more detailed information on the procedure, see [Traces \(Secure Trace\)](#).

---

**NOTICE:** The live recording of calls and connection data is a criminal offence, unless the affected parties have been notified in advance.

---

Parameter Description of Tabs:

- **Change Secure Trace Passphrase**
- **Import X.509 file for Secure Trace**

Parameters	Description
<b>Change Secure Trace Activation Passphrase</b>	
<b>Current Passphrase</b>	Current password (passphrase) for starting and stopping the secure trace
<b>New Passphrase</b>	New password (passphrase) for starting and stopping the secure trace Value range: 5 to 12 characters
<b>Confirm New Passphrase</b>	Identical new password (passphrase) for starting and stopping the secure trace Value range: 5 to 12 characters
<b>Certificate file (PEM or binary)</b>	Selection of the X.509 file that contains the certificate to be imported into the communication system.  After selecting the X.509 file, the fingerprint of the certificate to be imported can be displayed before importing the certificate into the communication system.  <b>INFO:</b> The certificate should be imported only after the fingerprint has been verified.

### 27.2.5.8 Traces > Secure Trace > Secure Trace Certificate

This function is used to display the imported secure trace certificate.

Parameter Description of Tabs:

- **Show Secure Trace Certificate**

### 27.2.5.9 Traces > Secure Trace > Secure Trace Settings

This function is used to query the status of a secure trace and to start or stop the secure trace.

Parameter Description of Tabs:

- **Secure Trace State**
- **Start/Stop Secure Trace**

Parameters	Description
<b>Current Secure Trace State</b>	
<b>Secure Trace is active</b>	Status of the Secure Trace
<b>Automatic Deactivation Time</b>	Time at which the secure trace is automatically disabled.
<b>Secure Trace for these protocols</b>	Displays the protocols for which the secure trace is created.
<b>Start Parameters</b>	
<b>Secure Trace Activation Passphrase</b>	Password (passphrase) for starting and stopping the secure trace
<b>Duration of Secure Trace (Mins.)</b>	Time period, in minutes, during which the secure trace is to be active. <i>INFO:</i> Entering a value is mandatory.
<b>Secure Trace for these protocols</b>	
<b>TC (TLS)</b>	When this flag is activated, the secure trace takes into account the TC (TLS) protocol. Default value: Disabled
<b>H.323 Core/HSA (TLS)</b>	When this flag is activated, the secure trace takes into account the H.323 Core/HSA (TLS) protocol. Default value: Disabled
<b>MMX (PEP)</b>	When this flag is activated, the secure trace takes into account the MMX (PEP) protocol. Default value: Disabled
<b>SIP Core/SSA (TLS)</b>	When this flag is activated, the secure trace takes into account the SIP Core/SSA (TLS) protocol. Default value: Disabled
<b>MSC (SRTP)</b>	When this flag is activated, the secure trace takes into account the MSC (SRTP) protocol. Default value: Disabled

### 27.2.5.10 Traces > Call Monitoring

This function can be used to start and stop the monitoring of trunk and station interfaces (also called subscriber line interfaces).

Parameter Description of Tabs:

- **Start/Stop Protocol**
- **Display**
- **Load via HTTP**



Parameters	Description
<b>Selected Port</b>	Trunk or station interface for which the call monitoring is to be started or stopped.
<b>No.</b>	Sequential number.
<b>Time</b>	Time of the event.
<b>Call number / Access</b>	Call number and physical interface.
<b>State</b>	<p>State of the interface.</p> <p>The following interface states are possible:</p> <ul style="list-style-type: none"> <li>• Idle (interface is dormant)</li> <li>• Call Initiated (interface is ready)</li> <li>• Overlap Sending (external sending of digits)</li> <li>• Outgoing Call Proc (end of dialing)</li> <li>• Call Request (waiting for alert)</li> <li>• Call Present (interface is ringing)</li> <li>• Active (interface is in talk state)</li> <li>• Hold (interface is in the hold state)</li> <li>• Disconnect Indication (request to disconnect an active call)</li> <li>• Direct (interface is in speaker call mode)</li> <li>• Intrusion (intrusion is activated.)</li> <li>• Callback A (callback subscriber A)</li> <li>• Callback B (callback subscriber B)</li> <li>• Busy (interface is busy)</li> <li>• Error (error state)</li> <li>• Disconnect PI (waiting for PI (progress indicator) release)</li> <li>• Sensor (signal was sent by sensor.)</li> <li>• Conference Master</li> <li>• Paging</li> <li>• Help Dial (Associated Dialing is used.)</li> <li>• Remote (interface occupied through remote service or DISA)</li> <li>• ACD (call distribution)</li> <li>• Unknown State</li> </ul>

Parameters	Description
<b>Event</b>	<p>Event</p> <p>The following events are possible:</p> <ul style="list-style-type: none"> <li>• Setup (trunk interface: incoming or outgoing seizure)</li> <li>• Setup Ackn (trunk interface: seizure acknowledgment)</li> <li>• Info (trunk interface: Info (Number Digits))</li> <li>• Call Proc (trunk interface: unevaluated end-of dialing)</li> <li>• Progress (trunk interface: additional info for call setup)</li> <li>• Alert (trunk interface: evaluated end-of dialing)</li> <li>• Connect (trunk interface: connection of B channel)</li> <li>• Connect Ackn (trunk interface: acknowledgement of connecting B-channel)</li> <li>• Disconnect (trunk interface: request for disconnect)</li> <li>• Release (trunk interface: acknowledgement of disconnect)</li> <li>• Release Compl (trunk interface: connection released)</li> <li>• Monitor On (trunk/station interface: call monitoring started)</li> <li>• Monitor Off (trunk/station interface: call monitoring stopped)</li> <li>• Off Hook (station interface: handset lifted)</li> <li>• On Hook (station interface: handset cradled)</li> <li>• Digit (station interface: digits are dialed)</li> </ul>
<b>auto refresh</b>	<p>If the flag is enabled, the call monitoring display is automatically refreshed.</p> <p>Default value: Enabled</p>
<b>Seconds until next automatic refresh</b>	<p>Time in seconds after which the call monitoring is to be refreshed.</p>

### 27.2.5.11 Traces > H.323 Stack Trace

This function is used to track problems with components that use the H.323 protocol.

Changes to the settings should only be made if requested by the responsible Service Support.

Parameter Description of Tabs:

- **Edit H.323 Stack Trace Configuration**
- **Edit All H.323 Modules**
- **Load H.323 Trace Log via HTTP**
- **Clear H.323 Trace Log**

Parameters	Description
<b>General</b>	
<b>Trace level</b>	Level of detail for the trace (trace level 0 = lowest level of detail to trace level 4 = maximum level of detail) Default value: 2
<b>Console Trace</b>	
<b>Switch Console Trace On</b>	When this flag is activated, H.323 Stack Trace messages are output to the console. Default value: Disabled
<b>File Trace</b>	
<b>Switch File Trace On</b>	When this flag is activated, H.323 Stack Trace messages are written to a log file. Default value: Disabled
<b>Maximum Trace Buffer Size (byte)</b>	Maximum size of the trace buffer in bytes (amount of data stored in the buffer.)
<b>Maximum Trace File Size (byte)</b>	Maximum size of the trace log file in bytes
<b>Trace Timer (sec)</b>	Time, in seconds, after which trace data is written to the log file.
<b>Module Name</b>	Name of the H.323 Stack Trace Module
<b>Trace On</b>	When this flag is activated, the H.323 stack trace module is enabled.

### 27.2.5.12 Traces > License Component

This function is used to monitor the system-internal license agent (Customer License Agent, CLA).

Changes to the settings should only be made if requested by the responsible Service Support.

Parameter Description of Tabs:

- **Change the CLA trace component**

Parameters	Description
<b>Package Name</b>	Name of the license trace component.
<b>Trace level</b>	Defines the level of detail for the trace of the license trace component Default value: low
<b>Trace level: Low</b>	Low level of detail for the trace recording.
<b>Trace level: Standard</b>	Medium level of detail for the trace recording.
<b>Trace level: All</b>	High level of detail for the trace recording.
<b>Trace level: Off</b>	License trace component stopped.

### 27.2.5.13 Traces > Trace Profiles

Trace profiles contain predefined trace components for monitoring complete functional units of the communication system.

Parameter Description of Tabs:

- **Display all Trace Profiles**
- **Add Trace Profile (Empty Profile)**
- **Add Trace Profile (with Current Trace Settings)**
- **Stop all Trace Profiles**
- **Start/Stop Trace Profile**

Parameters	Description
<b>Profile Name</b>	Name of the trace profile
<b>Profile started</b>	Indicates whether a trace profile has been started.
<b>This trace profile is read-only</b>	Indicates whether a trace profile is read-only (all existing default trace profiles are read-only).
<b>Trace Component</b>	Name of the trace component
<b>Included</b>	When this flag is activated, the trace component is included in the new trace profile to be added.  Default value: Enabled
<b>Level</b>	Level of detail for the recording of the trace component (trace level 0 = lowest level of detail to trace level 9 = maximum level of detail)

### 27.2.5.14 Traces > Trace Components

Trace components can be used to record the process and status information of individual components of the communication system.

Parameter Description of Tabs:

- **Display All Trace Components**
- **Display Started Trace Components**
- **Display Stopped Trace Components**
- **Edit Trace Components**
- **Stop all Trace Components**
- **Start/Stop Trace Component**

Parameters	Description
<b>Subsystem Name</b>	Name of the trace component
<b>Trace Component Index</b>	Sequential number
<b>Trace level</b>	Level of detail for the trace (trace level 0 = lowest level of detail to trace level 9 = maximum level of detail)
<b>Trace On</b>	When this flag is activated, the trace component data is recorded.

### 27.2.5.15 Traces > TCP Dump

A TCP dump is used for monitoring and evaluating data traffic in an IP network. An appropriate application is required for the diagnosis of the TCP dump files.

Parameter Description of Tabs:

- **TCP Dump State**

Parameters	Description
<b>Start TCP Dump</b>	Starts the TCP dump
<b>Start Parameter</b>	
<b>Interface Name</b>	Interface for which the data traffic is evaluated. The available interfaces are displayed under <b>Interface Details</b> . If you select <b>any</b> , the data traffic will be evaluated for all available interfaces. Default value: any
<b>Packet Size</b>	Size of data packets to be recorded (in bytes). <b>0</b> means that each packet will be recorded in its entirety. Value range: 0 to 2000000000, default value: 0
<b>Criteria for Terminating</b>	
<b>Number of Packets</b>	Number of data packets after which the TCP dump will be stopped.
<b>Time until Stop (sec)</b>	Time in seconds after which the TCP dump will be stopped.
<b>Stop TCP Dump</b>	Stops the TCP dump
<b>Cleanup TCP Dump</b>	Deletes the TCP dump files stored in the communication system
<b>auto refresh</b>	When this flag is activated, the status display is refreshed automatically. Default value: Enabled

### 27.2.5.16 Traces > rpcap Daemon

An RPCAP (Remote Packet Capture) daemon is used for monitoring and evaluating data traffic in an IP network. The RPCAP daemon enables external applications to remotely access the TCP/IP packets on the LAN interfaces of the communication system. An RPCAP a daemon is often used for long-term traces, since the trace files are stored on a PC and not in the communication system.

---

**NOTICE:** The safety notes listed in the tab must be observed.

---

Parameter Description of Tabs:

- **rpcap**

Parameters	Description
<b>Address to Bind to</b>	
<b>IP Address (either numeric or literal)</b>	IP address of the HOST used for the recordings. Default value: 0.0.0.0
<b>Port (please choose a free one)</b>	Port of HOST used for the recordings.
<b>Trace Internal LAN</b>	When this flag is activated, the data traffic between two boards is recorded via the eth9 interface. Default value: Disabled
<b>Client identification to allow access</b>	
<b>IP Address (either numeric or literal)</b>	IP address of the remote client on which the trace is output. Default value: 0.0.0.0

### 27.2.5.17 Traces > Auto DSP Trace

Parameter Description of Tabs:

- **Auto DSP Trace**

Parameters	Description
<b>Start DSP Trace</b>	Starts the DSP trace
<b>Stop DSP Trace</b>	Stops the DSP trace
<b>Auto DSP Trace</b>	DSP trace starts automatically depending on the selected level
<b>Auto DSP Trace Level(1-9)</b>	The level of the the DSP trace when Auto DSP trace is selected. Values from 1 to 9 are allowed.

## 27.2.6 Events

The functions for displaying and controlling events are grouped together under **Events**. These include event configuration, for instance, and e-mail settings.

### 27.2.6.1 Events > Event Configuration

Parameter Description of Tabs:

- **Edit Event Configuration**

Parameters	Description
<b>Event File Settings</b>	
<b>Maximum Event Buffer Size (byte)</b>	Displays the maximum event buffer size in bytes
<b>Maximum Event File Size (byte)</b>	Displays the maximum size of the event log file in bytes
<b>Event Timer (sec)</b>	Displays the time in seconds after which a new event log file is created.
<b>Event via LAN (XTracer)</b>	
<b>Switch Event Logging via LAN On (XTracer)</b>	When this flag is activated, event log messages are transmitted via the LAN interface. Default value: Disabled
<b>Timer Value (sec)</b>	Displays the time in seconds after which event log data is transmitted via the LAN interface.

### 27.2.6.2 Events > Event Log

This function is used to download or delete the event log file.

Parameter Description of Tabs:

- **Load via HTTP**
- **Clear Event Log**

### 27.2.6.3 Events > E-mail

Parameter Description of Tabs:

- **Edit E-mail Settings**

Parameters	Description
<b>E-mail Settings</b>	
<b>Subject</b>	Text that appears in the Subject field of the e-mails.
<b>E-mail Address (Recipients)</b>	
<b>Recipient 1</b>	E-mail address to which an e-mail is sent when an event occurs.
<b>Recipient 2</b>	E-mail address to which an e-mail is sent when an event occurs.
<b>Recipient 3</b>	E-mail address to which an e-mail is sent when an event occurs.
<b>Recipient 4</b>	E-mail address to which an e-mail is sent when an event occurs.
<b>Recipient 5</b>	E-mail address to which an e-mail is sent when an event occurs.

## 27.2.6.4 Events > Reaction Table

For each possible event, the Reaction Table can be used to independently define what action is to be taken when that event occurs.

Parameter Description of Tabs:

- **Edit All Events**
- **Restore All Events to Default Settings**
- **Edit Event**
- **Start/Stop Associated Trace Profile**

Parameters	Description
<b>Event Name</b>	Name of the event
<b>Send an SNMP Trap</b>	When this flag is activated, an SNMP trap is sent when the event occurs.
<b>Send Email</b>	When this flag is activated, an e-mail is sent to the e-mail recipient specified under <b>Edit E-mail Settings</b> when the event occurs.
<b>Associated Trace Profile</b>	Trace profile which is started or stopped when the event occurs.
<b>Start Trace Profile</b>	When this flag is activated, the selected trace profile is started when the event occurs.
<b>Stop Trace Profile</b>	When this flag is activated, the selected trace profile is stopped when the event occurs.
<b>Reboot the Gateway</b>	Indicates whether the communication system is restarted when the event occurs.
<b>Reboot the Gateway: Yes</b>	The communication system is restarted when the event occurs.
<b>Reboot the Gateway: No</b>	The communication system is not restarted when the event occurs.
<b>Notify OpenScope</b>	Indicates whether a message is sent to the communication system when the event occurs.
<b>Notify OpenScope: Yes</b>	A message is sent to the communication system when the event occurs.
<b>Notify OpenScope: No</b>	No message is sent to the communication system when the event occurs.

## 27.2.6.5 Events > Diagnosis Logs

Displays the diagnosis logs (log files) that were created automatically during critical system conditions.

Parameter Description of Tabs:

- **Get Diagnosis Logs**
- **Clearing Diagnosis Logs**

Parameters	Description
<b>File name</b>	Name of the diagnosis log (log file) stored in the communication system



Parameters	Description
Size (in Byte)	Size of the diagnosis logs in bytes
Modified	Modification date of the diagnosis log
Permissions	Attributes of the diagnosis log: <ul style="list-style-type: none"> <li>• r = read access</li> <li>• w = write access</li> </ul>

### 27.2.6.6 Events > Alarm Signaling

The stations (system telephones with display, UP0 & HFA) to be notified when the system temperature exceeds 55 degrees Celsius. If the temperature exceeds 60 degrees Celsius, the boards responsible for the overheating (e.g., OCAB, SLAD60/16) are shut down in a controlled manner or switched off.

Parameter Description of Tabs:

- **Edit alarm signaling**

Parameters	Description
<b>Temperature alarm signaling port</b>	
Station 1	Target 1 (subscriber with system phone).
Station 2	Target 2 (subscriber with system phone).
Station 3	Target 3 (subscriber with system phone).

### 27.2.7 Restart / Reload

Can be used to initiate a restart or reload of OpenScape Business and for a controlled shutdown of OpenScape Business X. In addition, a restart (reboot) of the UC application (UC Smart or UC Suite) or the UC Booster Card (Application Board OCAB) is triggered. To enable the controlled shutdown of OpenScape Business X via a system telephone, a PIN can be defined. In the case of a network, the networked communication systems can be synchronized.

## 27.2.7.1 Restart / Reload > Restart / Reload

Parameters	Description
<b>System</b>	
<b>Maintain Server</b>	Controlled restart of OpenScape Business: <ul style="list-style-type: none"> <li>OpenScape Business S und OpenScape Business X: a controlled restart of the communication system occurs. If OpenScape Business X3/X5/X8 is equipped with a UC Booster Card (Application Board OCAB), a controlled restart (reboot) of the UC Application (UC Smart or UC Suite) also occurs.</li> <li>OpenScape Business UC Booster Server (Application Server): a controlled restart of the OpenScape Business portion and the UC Application (UC Suite) occurs.</li> </ul>
<b>Reload system</b>	Reload OpenScape Business: <ul style="list-style-type: none"> <li>OpenScape Business S and OpenScape Business X: the communication system is reloaded. After the subsequent startup, the communication system will be in its default state. All country and customer-specific settings were deleted (system country code = Germany). The communication system has the default IP address 192.168.1.2 and the internal IP range 192.168.3.xxx. The licensing is retained.</li> <li>OpenScape Business UC Booster Server: the OpenScape Business portion is reloaded. After the subsequent startup, the OpenScape Business portion will be in its default state. All custom (i.e., customer-specific) settings of the OpenScape Business portion (e.g., the User Directory) were deleted. The licensing is retained. The operating system will not be reset.</li> </ul>
<b>Shut down system</b>	Controlled shutdown of OpenScape Business X: <ul style="list-style-type: none"> <li>OpenScape Business X3/X5: The subsequent startup of the communication system is only possible by unplugging and then reinserting the power plug.</li> <li>OpenScape Business X8: the subsequent startup of the communication system is only possible by switching off all LUNA2 power supplies and then switching them back on again.</li> </ul>
<b>Enable/disable shutdown</b>	Define a PIN to activate the shutdown (the controlled shutdown of the communication system) at a system telephone
<b>Restart Application Board</b>	Controlled restart of the Application Board OCAB, including the UC application (UC Smart or UC Suite):  During a restart of the Application Board OCAB, all active applications such as myPortal for Desktop, myPortal Smart and myAttendant, for example, are disconnected. After the startup, all connections are automatically set up again.
<b>Applications</b>	
<b>Sync Network</b>	Synchronization of networked communication systems:  After any phone numbers, DID numbers or names have been changed, the data in all networked communication systems are updated through synchronization.
<b>Restart UC Application</b>	Controlled restart of the UC application (UC Smart or UC Suite):  During a restart of the UC Application, all active applications such as myPortal for Desktop, myPortal Smart and myAttendant, for example, are disconnected. After the startup, all connections are automatically set up again.

## 27.2.8 SNMP

The functions for configuring communities and traps are grouped together under **SNMP**. Communities are used to regulate SNMP data access authorizations. Traps are generated if system problems occur to inform administrators of errors and failures.

### 27.2.8.1 SNMP > Communities

Parameter Description of Tabs:

- **Display Communities**

Parameters	Description
<b>IP address</b>	IP address of the SNMP communication partner. At address 127.0.0.1, any communication with external IP addresses is blocked.
<b>Community</b>	Identification/Access password for the SNMP user. <b>INFO:</b> To increase security, it is recommended that the default value <b>public</b> not be used.
<b>Type</b>	Selection of the type.
<b>Type: Read Community</b>	Communication partner with SNMP read access.
<b>Type: Read Community</b>	Communication partner with SNMP read and write access.
<b>Type: Trap-Community</b>	Communication partner to which error messages (traps) are sent.

### 27.2.8.2 SNMP > Communities > Read Communities

Parameter Description of Tabs:

- **Display Read Communities**
- **Add Read Community**

Parameters	Description
<b>IP address</b>	IP address of the SNMP communication partner. At address 127.0.0.1, any communication with external IP addresses is blocked.
<b>Community</b>	Identification/Access password for the SNMP user. <b>INFO:</b> To increase security, it is recommended that the default value <b>public</b> not be used.

### 27.2.8.3 SNMP > Communities > Write Communities

Parameter Description of Tabs:

- **Display Write Communities**
- **Add Write Community**

Parameters	Description
<b>IP address</b>	IP address of the SNMP communication partner. At address 127.0.0.1, any communication with external IP addresses is blocked.
<b>Community</b>	Identification/Access password for the SNMP user. <b>INFO:</b> To increase security, it is recommended that the default value <b>public</b> not be used.

#### 27.2.8.4 SNMP > Communities > Traps Communities

Parameter Description of Tabs:

- **Display Trap Communities**
- **Add Trap Community**

Parameters	Description
<b>IP address</b>	IP address of the SNMP communication partner. At address 127.0.0.1, any communication with external IP addresses is blocked.
<b>Community</b>	Identification/Access password for the SNMP user. <b>INFO:</b> To increase security, it is recommended that the default value <b>public</b> not be used.

#### 27.2.8.5 SNMP > Traps

Parameter Description of Tabs:

- **Display All Traps**
- **Display All Critical Traps**

Parameters	Description
<b>VarBind1 (Severity)</b>	Trap classification: <ul style="list-style-type: none"> <li>• Critical: error message. This error causes problems.</li> <li>• Major: error message. This error could cause problems.</li> <li>• Minor: error message. The error has no problematic consequences.</li> <li>• Warning: report of a possibly problematic procedure or status.</li> <li>• Cleared: the cause of the error message was resolved (for example, the port is operating again)</li> <li>• Information: plain status messages, no error messages</li> </ul>
<b>VarBind2 (Name)</b>	Trap name
<b>Generic Name</b>	General Description such as Enterprise Specific, for example
<b>Specific Name</b>	Type of trap: <ul style="list-style-type: none"> <li>• 1 = Software</li> <li>• 2 = Hardware</li> </ul>

Parameters	Description
Enterprise	(not used)
Time	Time of error
Index	Sequential number

## 27.2.9 Admin Log (also called Admin Protocol)

The administrator can use **Admin Log** to change the configuration (e.g., the language) of the administration log.

### 27.2.9.1 Admin Protocol > Configuration

Parameter Description of the Tab:

- **Edit Configuration**

Parameters	Description
Admin Log Language	Setting of the preferred language for the Admin Log. The Admin Log provides an overview of the changes made at the communication system.  Possible languages: German, English, French, Spanish, Italian, Portuguese, Dutch

### 27.2.9.2 Admin Protocol > Admin Log Data

Parameter Description of the Tab:

- **Load via HTTP**

Parameters	Description
Load via HTTP	Saves the Admin log of the communication system. The Admin log enables you to track when and by whom changes were made to the communication system. All logins at the communication system are logged.

## 27.2.10 Actions

The functions that support the administrator with repetitive administration tasks such as deleting log data are grouped together under **Actions**.

### 27.2.10.1 Actions > Manual Actions > Diagnosis Logs

Parameter Description of Tabs:

- **Load data via HTTP**

Parameters	Description
<b>Trace Log</b>	<p>When this flag is activated, the system trace log files are downloaded. The following choices are available:</p> <ul style="list-style-type: none"> <li>• Complete Trace Log: The full set of existing system trace log files is downloaded.</li> <li>• Log from Today: The system trace log files of the current day (as of 00:00 hours) are downloaded.</li> <li>• Own Selection: From: XXX To: YYY: The system trace log files of the selected time period are downloaded.</li> </ul> <p>Default value: Enabled, Complete Trace Log</p>
<b>Event Log</b>	<p>When this flag is activated, log files with information about actions and events of the communication system (reset, power on/off, etc.) are downloaded.</p> <p>Default value: Enabled</p>
<b>Admin Log</b>	<p>When this flag is activated, log files with information about administration procedures (login attempts, etc.) are downloaded.</p> <p>Default value: Enabled</p>
<b>Licence Protocols</b>	<p>When this flag is activated, log files with messages about the communication system components that require licenses are downloaded.</p> <p>Default value: Enabled</p>
<b>Customer Trace</b>	<p>When this flag is activated, log files with messages for the customer (remote login, ITSP login, etc.) are downloaded. The messages for the customer trace are provided in a more detailed format than in the trace log, for example.</p> <p>Default value: Enabled</p>
<b>Framework Protocol</b>	<p>When this flag is activated, log files with WBM messages are downloaded.</p> <p>Default value: Enabled</p>
<b>Diagnosis Log</b>	<p>When this flag is activated, the diagnosis logs of the communication system are downloaded.</p> <p>Default value: Enabled</p>
<b>UC Suite Protocols</b>	<p>When this flag is activated, log files with UC Suite messages (UC Suite, SCP and MEB logs) are downloaded. The following choices are available:</p> <ul style="list-style-type: none"> <li>• Complete Trace Log: All existing UC Suite, CSP and MEB log files are downloaded.</li> <li>• Log from Today: The UC Suite, CSP and MEB log files of the current day (as of 00:00 hours) are downloaded.</li> <li>• Own Selection: From: XXX To: YYY: The UC Suite, CSP and MEB log files of the selected time period are downloaded.</li> </ul> <p>All log files are archived together in a compressed file. The following file naming conventions apply to the OpenScape Business logs: UC Suite log files = vs_yyyy_mm_dd.log, CSP log files = cspttrace_yyyy_mm_dd.log, MEB log files = mebtrace_yyyy_mm_dd.log</p> <p>Default value: Disabled</p>

Parameters	Description
<b>Application Protocols</b>	<p>When this flag is activated, log files with messages of the application side of the communication system (for example, CSP protocols) are downloaded.</p> <ul style="list-style-type: none"> <li>• Complete Trace Log: All existing log files are downloaded</li> <li>• Log from Today: The log files of the current day (as of 00:00 hours) are downloaded.</li> <li>• Own Selection: From: XXX To: YYY: The log files of the selected time period are downloaded.</li> </ul> <p>All log files are archived together in a compressed file.</p> <p>Default value: Disabled</p>
<b>System Diagnosis Logs</b>	<p>When this flag is activated, the diagnosis logs of the communication system are downloaded.</p> <p>Default value: Enabled</p>
<b>PPP Logs</b>	<p>When this flag is activated, log files with messages for the Point-to-Point Protocol are downloaded.</p> <p>Default value: Enabled</p>
<b>CoreLog Protocol</b>	<p>When this flag is activated, log files with information about the most recent state of the operating system are downloaded. CoreLogs are created during system restart, for example.</p> <p>Default value: Disabled</p>

### 27.2.10.2 Actions > Manual Actions > DLI Maintenance

Parameter Description of Tabs:

- **DLI Devices Maintenance**

Parameters	Description
<b>Delete Device</b>	Select the system telephone that is to be deleted. With this action, the system telephone is deleted from DLI database.
<b>Call no</b>	Phone number of the system telephone.
<b>Device type</b>	Type of the system telephone.
<b>IP Address</b>	IP address of the system telephone; direct link to the WBM of the system telephone.
<b>MAC Address</b>	MAC address of the system telephone.
<b>Current SW version</b>	Current software version of the system telephone.

### 27.2.10.3 Actions > Automatic Actions > Garbage Collection

Parameter Description of Tabs:

- **Edit Action**
- **Start/Stop Action**

Parameters	Description
<b>Action Activated</b>	When this flag is activated, automatic garbage collection will be performed on the communication system at regular intervals. After each garbage collection has been completed, the communication system performs a restart (reboot).  Default value: Disabled
<b>Start Time (after Midnight)</b>	Garbage collection is performed after midnight.  Example: Let us assume that the value entered in the <b>Hrs</b> field was 3 and in the <b>Mins</b> field was 30. This means the garbage collection action will be started at 3:30 a.m. every morning.  Default value: 3 hours, 00 min.
<b>Days on which to perform action</b>	Garbage collection is performed on the selected weekdays.  Default value: Enabled

#### 27.2.10.4 Actions > Automatic Actions > DLS Notification

Parameter Description of Tabs:

- **Edit Action**
- **Start/Stop Action**

Parameters	Description
<b>Action Activated</b>	When this flag is activated, the automatic login at an external DLS server is initiated on starting up the communication system.  Default value: Disabled
<b>IP address</b>	IP address of the external DLS server  Default value: 0.0.0.0
<b>Port</b>	Port of external DLS server  Default value: 10444
<b>User name</b>	User name for logging into the external DLS server
<b>Password</b>	Password for logging into the external DLS server

#### 27.2.11 Platform Diagnostics

Platform Diagnostics Option (only for Development).

#### 27.2.12 Application Diagnostics

Application Diagnostics Option (only for Development).



### **27.2.12.1 Application Diagnostics > Developer Settings > Trace Console Output**

Application Diagnostics Option (only for Development).

### **27.2.12.2 Application Diagnostics > Developer Settings > Take Over Write Token**

Application Diagnostics Option (only for Development).

### **27.2.12.3 Application Diagnostics > Mainboard**

Changes to the settings should only be made if requested by the responsible Service Support.

### **27.2.12.4 Application Diagnostics> Developer Settings> SIP Provider Profiles**

Parameter description of tags:

- Add SIP provider profiles
- Edit SIP provider profiles

This page is intended for use by well trained technicians during the certification of a new ITSP. Please read the documents available in the unify wiki: [http://wiki.unify.com/index.php/Collaboration\\_with\\_VoIP\\_Providers#How\\_to\\_get\\_a\\_new\\_VoIP\\_provider\\_released](http://wiki.unify.com/index.php/Collaboration_with_VoIP_Providers#How_to_get_a_new_VoIP_provider_released) for more information.

## **27.2.13 IP Diagnostics**

IP Diagnostics Option (Only for Development).

### **27.2.13.1 IP Diagnostics > Mainboard > Address Resolution Protocol**

This function is used to display the data of the Address Resolution Protocol ARP. The mapping table shows the assignment of network addresses to MAC addresses.

Parameter Description of Tabs:

- **Display Address Resolution Protocol**

Parameters	Description
<b>IP address</b>	Displays the network addresses that are currently connected to the mainboard of the communication system.
<b>MAC Address</b>	Displays the physical address of the connected network addresses
<b>Type</b>	Displays the address assignment type. Fixed (static) or dynamic assignment.
<b>Interface</b>	Internal designation of the existing LAN interfaces (e.g., eth0, eth1, eth2, eth3)

### 27.2.13.2 IP Diagnostics > Mainboard > ICMP Request > Ping

This function can be used to check the network connection between the communication system and a freely selectable target address with a ping command (echo request).

Parameter Description of Tabs:

- **Execute Ping**

Parameters	Description
<b>ICMP Parameter</b>	
<b>Target Address</b>	IP address of the target whose network connection to the communication system is checked using echo request packets. Default value: 127.0.0.1
<b>Number of Echo Requests to Send</b>	Number of echo request packets to be sent for checking the network connection Default value: 3

### 27.2.13.3 IP Diagnostics > Mainboard > ICMP Request > Traceroute

This function uses ICMP echo requests to determine via which routers data packets are transmitted to the requested target address.

Parameter Description of Tabs:

- **Trace route**

Parameters	Description
<b>ICMP Parameter</b>	
<b>Target Address</b>	IP address of the target whose traceroute to the communication system is checked using ICMP echo requests. Default value: 127.0.0.1
<b>TOS Byte</b>	Indicates whether TOS (Type of Service) bytes are sent. TOS bytes provide information on the quality of a service. Value range: 0 to 255, default value: 0

## 27.2.14 Online User

Web tool for remote control of OpenStage phones.

### 27.2.14.1 Online Users

The Online User opens the Java Husim Phone Tester (jHPT). This is a web-based tool to remotely control OpenStage telephones via the Internet. Using a web interface, an existing system telephone is controlled by transmitting real keystrokes and displays of the communication system. Separate documentation is available for the jHPT, which can be downloaded via the Help function of the tool (so no further description of the jHPT pages is provided here).

## 27.3 Telephony

The functions for configuring the telephony settings (such as subscriber configuration or Call Management (CM), for example) are grouped under **Telephony**.

### 27.3.1 Basic Settings

Functions for configuring system flags, directory settings and speed dials, DynDNS, Quality of Service, date and time, and call charges are grouped together under **Basic Settings**.

#### 27.3.1.1 Basic Settings > System > System Flags

Parameter Description of Tabs::

- **Edit System Flags**

Parameters	Description
<b>Through-connection for external FWD on</b>	<p>When this flag is activated, calls forwarded to an external destination are put through immediately. The forwarding occurs regardless of whether an internal or external (MSI/ISDN) call is involved. If the call forwarding occurs via an ISDN trunk, and the external forwarding destination is located in another network (such as a GSM network, for example), the call setup from the ISDN Central Office is reported with the progress indicator Leaving ISDN. As of this point in time, the caller incurs connection charges.</p> <p>Default value: Disabled</p>
<b>Call forwarding to main station interface permitted</b>	<p>When this flag is activated, calls over analog trunks (MSI) follow the external call forwarding.</p> <p>Default value: Enabled</p>
<b>Hunting to external call forwarding destination</b>	<p>When this flag is activated, the following applies: if the external call forwarding destination cannot be reached, the call is forwarded to the next destination entered in the call destination list.</p> <p>Default value: Disabled</p>
<b>Conference tone</b>	<p>When this flag is activated, the participants of a conference are reminded that they are currently in a conference call by a special tone at intervals of 20 seconds.</p> <p>Default value: Disabled</p>
<b>Warning signal for call pickup groups</b>	<p>When this flag is activated, a call for a member of a call pickup group is signaled to the other group members with an optical signal (via the display). If the call is not answered within four call cycles (4 x 5 seconds), the other group members also receive a warning tone.</p> <p>Default value: Enabled</p>
<b>Increase volume for optiPoint/ OpenStage terminals</b>	<p>When this flag is activated, optiPoint and OpenStage phones are switched to an alternative attenuation plan, which increases the volume.</p> <p>Default value: Disabled</p>
<b>Relocate allowed</b>	<p>When this flag is activated, system telephones can be physically relocated without changing the logical configuration (call number, name, key programming, etc).</p> <p>Default value: Disabled</p>
<b>More than 1 external conference member</b>	<p>When this flag is activated, multiple external subscribers can attend a conference.</p> <p>Default value: Enabled</p>
<b>Trunk reservation, automatic</b>	<p>When this flag is activated, a subscriber can reserve a trunk in advance if there are no free trunks available (busy signal). The subscriber receives a recall as soon as this trunk becomes free and can then set up the external connection.</p> <p>Default value: Disabled</p>
<b>No. redial with a/c code</b>	<p>When this flag is activated, on redialing, any account code that was entered is also repeated in addition to the station number.</p> <p>Default value: Disabled</p>

Parameters	Description
<b>Simplified dialing</b>	<p>When this flag is activated, dialing a single digit at a system telephone immediately triggers line seizure, and the required call number is dialed. It is not necessary to dial the access code. To dial an internal station, one of the following procedures must be used:</p> <ul style="list-style-type: none"> <li>• Press the Internal key (Mute will change to Internal, if simplified dialing is active) and dial the station number</li> <li>• or press the corresponding DSS key.</li> </ul> <p>This function is only available if only one route (see Routes) has been configured.</p> <p>If Entry, ISDN or a/b telephones are still connected in the communication system, LCR with automatic dialing is not possible.</p>
<b>Use only default number for MSN</b>	<p>When this flag is activated, on an S0 bus, MSNs (Multiple Subscriber Numbers) can only be created for already existing internal station numbers (to prevent any possible toll fraud).</p> <p>Default value: Disabled</p>
<b>Path optimization</b>	<p>When this flag is activated, path optimization is performed in networked communication systems. The flag must be enabled for all communication systems belonging to a network. Example for two networked systems (system 1 and system 2): For a call from subscriber A (system 1) to subscriber B (system 2) and subsequent call forwarding to subscriber C (system 1), two trunks are reserved. With path optimization, the connection from A to C is automatically switched over a single trunk.</p> <p>Default value: Enabled</p>
<b>DTMF automatic</b>	<p>When this flag is activated, it causes DTMF mode to be activated each time an outgoing call is set up. This enables answering machines to be checked remotely, for example.</p> <p>Default value: Enabled</p>
<b>Broadcast with connection</b>	<p>When this flag is activated, the Speaker call (Paging) function lets you set up an internal connection without the called subscriber lifting the handset. On lifting the handset, the call becomes a normal two-party call.</p> <p>Default value: Enabled</p>
<b>Tone from CO</b>	<p>When this flag is activated, a connection is switched through to the Central Office or to a networked communication system even if no tone is sent from the peer.</p> <p>Default value: Disabled</p>
<b>Ringback protection</b>	<p>When this flag is activated, collect calls are automatically released.</p> <p>Default value: Disabled</p>
<b>Euro-impedance</b>	<p>When this flag is activated, the following impedance values apply in Europe:</p> <p>a/b interfaces for the analog station connection: Input impedance = 270 Ohms + 750 Ohms    150 nF, Second ringer impedance = 270 Ohms + 750 Ohms    150 nF, Relative Level A/D = 0 dBr, Relative Level D/A = -7 - 7 dBr</p> <p>a/b interfaces for the analog trunk connection: Input impedance = 270 Ohms + 750 Ohms    150 nF, Second ringer impedance = 270 Ohms + 750 Ohms    150 nF, Relative Level A/D = -6 - 6 dBr, Relative Level D/A = -1 - 1 dBr</p> <p>Default value: Disabled</p>

Parameters	Description
<b>Different phonemail messages Day/Night</b>	<p>When this flag is activated (in a communication system with Voicemail), different Voicemail announcements can be activated for a station by transmitting different station numbers for that station to the Voicemail. As a prerequisite, different call forwarding destinations for day and night modes must be configured for that station.</p> <p>Default value: Disabled</p>
<b>Display international / national code number</b>	<p>When this flag is activated, you can define the display format for system speed dialing (SSD) numbers for incoming calls for which no name is stored in the SSD memory. The complete phone number (PABX number + Direct Inward Dialing (DID) number, including the local area code and country code, if available) is shown on the display of the phone. Example: The SSD number 06671234 was set up without a name. Local area code = 02302, PABX number = 667, DID number = 1234. In the case of an incoming call from 6671234, the number 023026671234 appears on the display.</p> <p>Default value: Disabled</p>
<b>Line change for direct call</b>	<p>This flag is used to define the behavior of a Direct Station Select (DSS) key during an active call on a MULAP trunk. Relevant for Team Configuration / Team Group, Executive/ Secretary / Top Group, Basic MULAP, Executive MULAP. On pressing a Direct Station Select (DSS) key, a line change is performed. The call is placed on hold and can only be resumed at this phone.</p> <p>Default value: Disabled (not for U.S. and Canada), Enabled (for U.S. and Canada only)</p>
<b>Automatic redial</b>	<p>Automatic redialing is performed when a called subscriber is busy. The time parameter Timer for automatic redial defines after how much time the redialing is activated.</p> <p>Default value: Disabled</p>
<b>Voice mail Node call number</b>	<p>When this flag is activated for networked communication systems, it defines whether or not the node number must be supplied for the identification of one central or multiple decentralized voicemail server(s). The node number must be supplied for the identification of the voicemail server or servers.</p> <p>Default value: Disabled</p>
<b>Call Pickup after automatic recall</b>	<p>When this flag is activated, recalls and callbacks are also signaled at other members of a call pickup group and can be accepted by them.</p> <p>Default value: Disabled</p>
<b>Configurable CLIP</b>	<p>When this flag is activated, instead of the actual station number, the number entered under Clip/Lin is transmitted to the called external connection and presented on the display. If the Clip/Lin entry is empty, the station number is transmitted.</p> <p>Default value: Enabled</p>
<b>Caller list at destination in case of Forward Line</b>	<p>When this flag is activated, in case of a Forward Line Key (MULAP), incoming calls are entered in the caller list of the destination station.</p> <p>Default value: Disabled</p>

Parameters	Description
<b>Call forwarding after deflect call / single step transfer</b>	<p>When this flag is activated, the following applies: if a subscriber has enabled call forwarding to an external destination (call deflection), the call is signaled at that destination. After the call forwarding time has expired, the call is signaled at the first destination entered in the call destination list and subsequently at the second destination, if any, and so on. Example: For station A, a deflect call to station B was executed. The first destination entered in the call destination list of station B is station C, and the second destination is station D. In this case, the call will be signaled at station C first and then at station D, after the call forwarding time has expired. The activation of this flag only makes sense if the flag Follow call management in case of deflect call / single step transfer is also activated.</p> <p>Default value: Enabled</p>
<b>Follow call management in case of deflect call / single step transfer</b>	<p>When this flag is activated, the following applies: if a subscriber has enabled call forwarding to an external destination (call deflection), the call is first signaled at that destination and subsequently at any further destination entered in the call destination list (after the call forwarding time has expired). Example: For station A, a deflect call to station B was executed. The first destination entered in the call destination list of station B is station C. After the call forwarding time has expired, the call is signaled at station C.</p> <p>Default value: Enabled</p>
<b>Warning tone during voice recording</b>	<p>If the flag is enabled, the following applies for OpenScape Business X: If voice recording (Live Call Record) is activated during a call, a corresponding advisory tone is output if the flag is set.</p> <p>Default value: Enabled</p>
<b>E.164 numbering scheme</b>	<p>This flag is used to activate or deactivate CDB networking of cross-location or worldwide customer systems. Stations can be reached via a public number (the E.164 call number) in national or international format (for example, internal calling party number in ISDN format), without dialing a node number first. Each station is represented by its E.164 call number, which can be displayed in an optimized format. If the flag is activated, the internal call number is transferred in E.164 format.</p> <p>If this flag is set, SIP stations are registered with the long version of the E.164 call number (location number + internal call number, for example, 4923026673665).</p> <p>Default value: Disabled</p>
<b>Extended Key Functionality</b>	<p>If the flag is enabled, once a key is defined as the "Shift key", only phone numbers without LED support can be saved at the second key level which is now available. Any key functions on the first key level can be programmed. LED signaling is associated with the first key level only.</p> <p>Default value: Disabled</p>
<b>Calling number in pick-up groups / ringing groups / CFN / RNA</b>	<p>When this flag is activated, the station number and name of a caller are displayed at all members of a call pickup group, all members included in a ringing group and at CFN (call forwarding) and CFNA (call forwarding on no answer) destinations. The station number and name are presented on the display.</p> <p>Default value: Enabled</p>
<b>SPE support</b>	<p>When this flag is activated, the Signaling and Payload Encryption (SPE) feature is supported. The VoIP payload and signaling data streams to and from the communication system and between OpenStage system telephones are encrypted.</p> <p>Default value: Disabled</p>

Parameters	Description
<b>SPE advisory tone</b>	<p>When this flag is activated, the following applies: when the system flag SPE Support is enabled, and an OpenStage 15, 20, 20 E or 20 G phone is used, subscribers are notified about an unencrypted connection by a beep tone in addition to the display. Enabling the station parameter Payload Security is a prerequisite for the usage of SPE by a subscriber. No beep tone is heard when using an OpenStage 40, 40 G, 60, 60 G, 80 or 80 G telephone. The status of the connection (encrypted/unencrypted) is permanently shown in the display.</p> <p>Default value: Disabled</p>
<b>SIP Prov. to SIP Prov. transit</b>	<p>When this flag is activated, transit line connections are allowed for ITSP connections. A connection is a transit connection when a single call occupies two lines in the same communication system. Example: An external is forwarded to an internal station via an ITSP. The internal station then transfers the call again to an external destination via an ITSP. This results in a transit line connection within the communication system. Two trunks are occupied for the duration of the call. The resulting transit line connections are allowed.</p> <p>Default value: Disabled</p>
<b>Transparent dialing of * and # on trunk interfaces</b>	<p>When this flag is activated, Centrex features can be enabled or disabled via IP trunks (ITSP) and ISDN trunks. Several providers offer Centrex (Central Office Exchange) features that can be enabled or disabled by using codes. The input of a code must occur in the dialing state (e.g., after entering the trunk code). The input always begins with * (asterisk) or # (pound). This must be followed by the actual code (digits 0 through 9) and terminated with # (pound). It is not possible to enable or disable Centrex features in the talk state. Centrex features can be enabled or disabled via IP trunks (ITSP) and ISDN trunks.</p> <p>Default value: Disabled</p>
<b>Add seizure code for MEX</b>	<p>Applies only to external calls that are initiated via the ITSP "Mobile Extension (MEX)" feature. If the flag is enabled, the system automatically adds the CO code to the phone number for external outgoing calls if the phone number consists of more than 7 digits, since the system then interprets it as an external phone number. If the phone number consists of less than 7 digits, the CO code is not added, since the system interprets the number as an internal call number. If the flag is disabled, then the service provider must add the CO code to the phone number for all external outgoing calls.</p> <p>Default value: Disabled</p>
<b>CMI MWI ringer</b>	<p>If this flag is enabled, the Message Waiting Indication (MWI) beep is activated for DECT phones (CMI: Cordless Multicell integration). In other words, when a new message is received in the voicemail box, an alert tone is sent.</p> <p>Default value: Disabled</p>
<b>Automatic Openstage TDM Phones Software Update</b>	<p>If this flag is enabled, when the software version of a TDM phone is older than the software version of the system then the software of the phone is automatically updated.</p> <p>Default value: Enabled</p>



Parameters	Description
<b>Restrict indirect trunk group connections according to CON Matrix</b>	<p>If a company has branches in several cities, then each branch can have a line to the national telecom provider. These branches can also be connected to one another via private tie trunks.</p> <p>For reasons of national regulations (e.g., in India) it can be illegal to make the following connection: A station uses the private tie trunk from their communications system to a private communications system in another city and then a national telecom provider trunk to reach a local external destination. Instead a national telecom provider trunk should be used directly for calls between cities. This requirement is implemented as follows:</p> <ul style="list-style-type: none"> <li>• Connections between private tie trunks can be restricted by configuring the CON matrix.</li> <li>• For private tie trunks which involve the features Call-forwarding, Transfer and Conference features, the flag "Restrict indirect trunk group connections according to CON Matrix" was introduced. Activating/deactivating this flag has the following effects: <ul style="list-style-type: none"> <li>– Activated: Calls between cities using private tie trunks are restricted.</li> <li>– Deactivated: Calls between cities using private tie trunks are permitted.</li> </ul> </li> </ul> <p>Default value: Disabled</p>
<b>Open numbering</b>	
<b>active</b>	<p>When open numbering is used, a station is identified by the node number, followed by the call number or the DID number. This makes it possible to assign the same call number to stations in different nodes. In a networked system, this flag is always set identically for all systems.</p> <p>Default value: Disabled</p>
<b>Node call number</b>	<p>If open numbering is set, the call number of the node must be entered here. A station can be reached from other nodes only by dialing this node call number, followed by the station number. If the total number of digits of the node call number and the station number exceeds 7, a corresponding warning is issued.</p> <p>Default value: Disabled</p>
<b>Transit permission</b>	
<b>Feature Transit</b>	<p>When this flag is activated, transit connections associated with specific features such as external call forwarding, call transfers and DISA applications, for example, are allowed. This applies regardless of whether tie trunk or trunk-to-trunk connections are involved.</p> <p>Default value: Enabled</p>
<b>Tie traffic transit</b>	<p>When this flag is activated, transit connections in direct inward dialing for tie trunk connections (networked communication systems) are allowed.</p> <p>Default value: Enabled</p>
<b>External traffic transit</b>	<p>When this flag is activated, transit connections in direct inward dialing for trunk-to-trunk connections are allowed.</p> <p>Default value: Disabled</p>
<b>Special switch</b>	
<b>CALL PROC no send</b>	<p>This flag must be enabled if the service provider should not receive any Call Proceeding Messages (ISDN message) from the communication system.</p> <p>Default value: Disabled</p>

Parameters	Description
<b>Automatic, cyclical line seizure</b>	If this flag is enabled, outgoing calls will cyclically seize new ISDN trunks when the connection setup fails (e.g., no ACK acknowledgement). Line numbers or route numbers are incremented.  Default value: Enabled
<b>Restriction for UC calls</b>	
<b>Restriction for UC calls</b>	When this flag is activated, for all UC calls initiated by the system (e.g., via the Call-Me service), a check is performed before dialing to determine whether the requesting UC user has the requisite class of service for that call. If the UC user does not have the required class of service, the call is not executed.  Default value: Disabled

### 27.3.1.2 Basic Settings > System > Time Parameters

All adjustable time parameters are listed in the table (**Description** column). The timer value for each time parameter can be set via the **Base** and **Factor** columns. The actual time = Base x Factor. If the value 255 is entered in the **Factor** column, this timer is inactive.

Parameter Description of Tabs::

- **Edit Time Parameters**

Parameters	Description
<b>P.O.T. suffix dialing time code / Receiver activation time</b>	Controls the duration of the connection of the code receiver with DTMF terminal units and therefore the ready-to-dial condition. After expiry of this timer the code receiver will be released.  Value range: 5 - 15 s
<b>Time for activation of P.O.T features</b>	Will be activated if the signal key is pressed. The signal key helps to distinguish whether a subscriber wants to resume a consultation hold or whether he wants to activate a feature such as conferencing.  Value range: 2 - 4 s
<b>Reseizure blocking time</b>	Is started after trunk release and bars an immediate outgoing seizure during this time.  Value range: 0 - 5 s
<b>Callback delay time</b>	Is started, if a subscriber changes into idle. Once this time has expired, a check is made to see whether automatic callback is to be implemented. This gives the user an opportunity to make further calls.  Value range: 0 - 60 s
<b>Length of call back</b>	In case an automatic callback is not answered within this time, the call is finished and the callback is postponed.  Value range: 15 - 60 s
<b>Intercept time for automatic recall</b>	If an automatic recall of a blind transfer is not answered within this time, it is intercepted to the attendant console, if this intercept criterion has been configured.  Value range: 20 - 600 s

Parameters	Description
<b>Dial time during transfer before answer</b>	If a blind transfer (to a busy station) is not answered within this time, the recall is forwarded to the extension that transferred the call.  Value range: 30 - 600 s
<b>End-of-selection for incomplete dialing (Austria)</b>	Supervisory timer for direct inward dialing. In case no selection occurs during this time, the direct inward dialing is recognized as incomplete or as no dialing. (Austria only)  Value range: 10 - 30 s
<b>End-of-selection time (no dialing)</b>	In case selection is not started within a certain time, an end-of-selection is automatically generated.  Value range: 5 - 15 s
<b>Time between 1st and 2nd announcement for FAX-DID</b>	Fax/DID, analog direct inward dialing, time after voice announcement.  Default value: 15 s
<b>Time for parking + change to hold</b>	Reactivation of a parked call must occur within a timeout. In case the parked call is not answered (resumed) within this time, the station, which has parked the call, will be recalled. With the automatic recall, the hold status reverts to an active status.  Value range: 60 - 255 s
<b>End-of-selection for incomplete dialing</b>	In case dialing is not continued within a certain time, an end-of-selection is automatically generated.  Value range: 10 - 20 s
<b>P.O.T. Minimum flash time</b>	Defines a minimum time for the recognition of a flash within which the loop must be broken.  Default value: 0 s
<b>P.O.T Maximum flash time</b>	Defines a maximum time for the recognition of a flash within which the loop may be broken.  Default value: 0 s
<b>Time for activation of automatic recall at attendant console</b>	In case an automatic recall at the attendant console is not answered during this time, the call will be released.  Value range: 30 - 180 s
<b>MSI NSA Lead time</b>	Lead time for the rotary dial normally open contact (NSA); is used to prevent dialing noise in the handset for pulse dialing equipment (before the pulse).  Default value: 0 s
<b>MSI NSA Follow time</b>	Follow time for the rotary dial normally open contact (NSA); is used to prevent dialing noise in the handset for pulse dialing equipment (after the pulse).  Default value: 0 s
<b>Fault extraction time for ring</b>	Time to hide line faults for pulse dialing.  Default value: 0 s
<b>End-of-dialing for 1A dialing</b>	Indicates the time after which the last digit will be dialed out for the 1A procedure. The outdialing of a digit occurs after input of the next digit. The last digit is dialed after expiry of the timer or if it is marked with the end of dialing indication (#) by the station.  Value range: 4 - 4.5 s

Parameters	Description
<b>Additional charge time</b>	When a trunk is released, incoming call charge information (call charge pulses) on analog trunks can be analyzed by the communication system during this time. The trunk is blocked for outgoing connections during this time. Default value: 0 s
<b>Interdigit time for pulse dialing</b>	Allowed delay between each digit for pulse dialing Default value: 10 s
<b>Dial tone monitoring time</b>	This is the waiting time for dialing tone. In case this timer expires, the system assumes a failure of the trunk. The trunk will be marked as "failed". Default value: 10 s
<b>Pause duration for pulse dialing</b>	Pulse dialing occurs through pulse-pause sequences and the detection of pauses on pulse-dialing lines. Default value: 0 s
<b>Pulse time for pulse dialing</b>	Pulse dialing occurs through pulse-pause sequences. Detection of pulses on pulse dialing lines. Default value: 0 s
<b>Flash time for PBXs</b>	Break time for station loop to trigger control functions (e.g., consultation) in the system. Default value: 0 s
<b>Flash time for trunks</b>	Break time for station loop to trigger control functions (e.g., consultation) on the MSI line. Default value: 0 s
<b>Minimum pulse time for pulse dialing-P.O.T.</b>	Pulse dialing occurs through pulse-pause sequences. Detection of pulses from the pulse dialing phone. Default value: 0 s
<b>Maximum pulse time for pulse dialing-P.O.T.</b>	Pulse dialing occurs through pulse-pause sequences. Detection of pulses from the pulse dialing phone. Default value: 80 ms
<b>Transmission time for DTMF signals</b>	Country-specific duration of DTMF dial characters. Default value: 80 ms
<b>Pause between DTMF signals</b>	Country-specific pause between DTMF dial characters. Default value: 80 ms
<b>MOH delay timer</b>	In case a connection is held, music on hold is applied, if configured. However, MOH is only activated after this time has expired, in order to make sure that activation of features such as conferencing is not hindered by MOH. Value range: 0 - 5 s
<b>Pause before dial (only for Development)</b>	If dial tone detection is not possible or desired for analog trunks, dialing can be automatically initiated after this time period. Default value: 3 s
<b>Minimum charge pause</b>	Time between call charge pulses. Default value: 0 min.

Parameters	Description
<b>Minimum charge impulse</b>	Duration of call charge pulses. Default value: 0 min.
<b>NSA Answer pulse time</b>	Rotary dial normally open contact (MSI lines) Default value: 0 s
<b>NSA Seizure pulse time</b>	Rotary dial normally open contact (MSI lines) Default value: 0 s
<b>Release if no dialing</b>	In case of a trunk seizure and no dialing within a certain time, the connection is released. The subscriber will get busy tone. Value range: 5 - 30 s
<b>DP P.O.T. Minimum interdigit time</b>	Time between dialed digits for pulse dialing telephones. Default value: 0 ms
<b>DTMF P.O.T. flash debounce time</b>	Prevents multiple detection of Flash button. Default value: 0 ms
<b>DTMF Settling time</b>	Waiting time to avoid disruption of DTMF signals on outgoing lines. Default value 100 ms
<b>Flash settling time (see help)</b>	Waiting time after flash on analog lines. Default value: 1 s
<b>Cycle length for recovery</b>	Time for restart of analog lines, after no dial tone was detected. Default value: 120 s
<b>Dial pause length</b>	Indicates the length of the pause to be implemented between two digits, if a pause mark is detected. Value range: 1 - 5 s
<b>Fault extraction time for calls in PABX operation ( see help)</b>	Time to hide line faults. Default value: 0 s
<b>Artificial end-of-selection</b>	With external dialing, received digits after artificial end-of-selection are interpreted as consultation hold. Value range: 5 - 15 s
<b>Timer for automatic redial</b>	If the station is busy, the relevant number is automatically redialed when the timer elapses. This feature does not work unless the option Automatic redial is selected under Flags. Value range: 10 - 650 s
<b>Fault extraction time for the first polarity change (France/ Spain)(see help)</b>	Time to hide line faults. Default value: 0 ms
<b>Delay for announcement prior to answer</b>	Adjusts the delay time, after which the announcement device answers. Value range: 1.5 - 30 s

Parameters	Description
<b>Time between HAT analysis and dialing of trunk main station interface</b>	Determines the time between the audible tone recognition and the dialing of the first digit via analog trunks. Value range: 0 - 2 s
<b>Pause length after dialing 2nd discrim. digit</b>	Determines the length of the pause to be implemented after dialing the 2nd route seizure code or the international code number. Transfer to the next switching node Value range: 1 - 5 s
<b>Time until warning tone in main station interface transit connection</b>	Transit connections are monitored depending on the type of protocols. This is to avoid, that a connection remains endlessly. If at least one trunk in this transit connection has release recognition, the time is not monitored (see the exceptions in the table below). There is no release recognition for analog trunks. However, there is a hardware option for silent reversal. This makes release recognition possible for analog trunks.  The Table for transit monitoring (the following is valid for the trunk types specific to the US:) shows the trunk types where a monitoring timer is implemented. The length of the monitoring can be configured. However, when using an analog trunk with silent reversal, note that there are call numbers where it's possible that there is no answer and therefore where no release can be recognized. As a rule, these call numbers are for announcement services. This must be explicitly pointed out to the operator of the communication system.  Value range: 120 s - 42 min
<b>Time from warning tone until release...</b>	In the case of monitoring the time for transit connections, a warning tone occurs after the monitoring timer expires. So that the call can be ended, the connection is only cleared down after this timer has expired, and not immediately.  Value range: 10 - 650
<b>Release time for MSI</b>	A call to an MSI line via direct inward dialing (DID) is released after this time if no call was connected.  Value range: 30 s - 254 min
<b>After holding, a warning tone is switched (Italy)</b>	After expiry of this time, camp-on occurs with the held connection at the subscriber who held the call (ITL).  Value range: 30 - 180 s
<b>LCR: Artificial end-of-selection</b>	Waiting time after the last digit until end of dialing is assumed (block dialing LCR).  Default value: 5 s
<b>Monitoring a UCD call to an analog line</b>	Time for activation of an MSI call to a UCD group when no connection has been set up.  Value range: 10 - 3810 s
<b>Monitoring transfer to a UCD group prior to answer (only for Development)</b>	If a transfer to a UCD group occurs prior to an answer, the timer is started. If the transferred call is not answered, an automatic recall occurs following the timeout.  Value range: 10 - 3810 s
<b>Delay timer for attendant console</b>	Time until update message is sent to the PC Attendant Console (Business Attendant).  Value range: 300 ms
<b>USBS timer interval</b>	For access via S0 port, TA-S0, TA-RS232 and TA-API the User Signaling Bearer Service (USBS) based on ETS 300 716 is used.  Value range: 1 - 60 s

Parameters	Description
<b>Timer for Toll Fraud Monitoring</b>	When this timer expires, an active transit connection is signaled at the display of the attendant console. The attendant will be able to release the transit call. This enables the monitoring of transit traffic. Value range: 0 - 650 s
<b>Special busy tone, if destination doesn't answer the call</b>	After expiry of this timer, the calling subscriber gets the special busy tone. Value range: 30 - 120 s
<b>Special busy tone, if trunk is seized without dialing</b>	In case a subscriber seizes an outgoing trunk without dialing, he will get a special busy tone after expiry of the timer. Value range: 20 - 60 s
<b>Calling time transfer before answer on busy station</b>	After expiry of this timer, subscriber A, which has been transferred from subscriber B to a busy subscriber C, is transferred back to subscriber B. Value range: 15 - 180 s
<b>Error signaling interval</b>	The error signaling time defines an interval in the value range 1 to 15 minutes. Decimal places are rounded up to full minutes, values under 1 min. or above 15 min. are evaluated as 15 min. The current Class B error entered in the event log is transferred cyclically to the remote center when the interval has elapsed. Value range: 60 - 900 s

### 27.3.1.3 Basic Settings > System > Display

Parameter Description of Tabs::

- **Edit Display**

Parameters	Description
<b>Display name / call number</b>	<p>It is possible to configure which of the following data is displayed for calls on the screens of all connected telephones: Calling ID only, Name (if present), or both Name and calling ID at the same time. If a telephone does not support one of these settings, instead of displaying the name and the calling ID at the same time, only the calling ID may be shown, for example. OpenStage telephones support the simultaneous display of the name and calling ID.</p> <p>Default value: Name and calling ID</p>
<b>Display name / algorithm</b>	<p>Full name support is done with three fields, one for the first name, one for the last name and a third for the display name. Display name field can store up to 16 characters, name and last name fields can store up to 32 characters.</p> <p>One of the following options of the display name algorithm can be used:</p> <ul style="list-style-type: none"> <li>• &lt;last name&gt;, &lt;first name&gt;</li> <li>• &lt;last name&gt;, &lt;first name initial.&gt;</li> <li>• &lt;first name&gt; &lt;last name&gt;</li> <li>• &lt;first name initial.&gt; &lt;last name&gt;</li> <li>• &lt;last name&gt;</li> </ul> <p>Default value: &lt;last name&gt;, &lt;first name&gt;</p>
<b>Transfer before answer</b>	<p>If a call is transferred before it has been answered, either the number of the party transferring the call or the number of the party placing the call can be displayed at the receiving station. A call which was switched by "Transfer before answer" cannot be rejected by the called party. If Transferred by is selected, the display will show the transferring party before the connection is established and after the call is released. If Transferred to is selected, the display will show the transferring party as long as the transferring party is connected to the receiving station. After the transferring party releases the call and there is a connection, the display will change from the transferring party to the transferred party.</p> <p>Default value: Transferred to</p>
<b>Automatic recall</b>	<p>If a call is transferred and then recalled, either the number of the party transferring the call or the number of the party recalling the call can be displayed at the receiving station. An internal B station displays the call transfer. C receives a ring tone until either B answers or A recalls. This item can be used to configure what is to be shown on the display of transfer destination B: either station A (caller) or C (transferred destination). If an automatic recall is started from station A, both stations receive the display no reply.</p> <p>Default value: Transferred destination</p>
<b>Date/Time format</b>	<p>The date can be displayed in various formats.</p> <p>Default value: Europe - 24 hour format</p>



Parameters	Description
<b>Caller list, mode</b>	<p>If Internal and external calls or Only external calls is activated, all calls that were not accepted are saved in a list whose contents can then later be retrieved using a system procedure. If All external calls whether answered or not is activated, then calls that have been accepted are also saved in the caller list. No call numbers are removed from the caller list, either for incoming or outgoing calls. If all of the memory locations in the caller list have already been used, the oldest entry is overwritten when an additional call number is saved. Calls that have not been accepted are displayed in the manner already described in the Missed Calls List feature. Calls that have been accepted are displayed in the same manner as for the "Save call number" functionality of the caller list. If an external incoming call is routed via the AutoAttendant to an internal station and the station is currently busy or has call forwarding activated, no entry is made to the missed calls list.</p> <p>Default value: External calls only</p>
<b>Call number suppression</b>	<p>When this flag is activated, the calling number is not displayed in ISDN, i.e., the called party does not see the calling number (this feature also needs to be activated at the telephone company). There are call scenarios in which a caller may have been set to "presentation restricted" by the Central Office. If this flag is enabled, the caller's number is displayed to the called party. If this flag is disabled, the text "Number unknown" appears. The flag always depends on the CO settings of each provider.</p> <p>Default value: disabled</p>
<b>Internal Phonebook</b>	<p>Users can access a system-wide online directory (phone book) that includes names and call numbers for all internal extensions. System-specific display terminals allow users to scroll through the directory, to display all available internal stations with their names and call numbers, and then dial any of the stored numbers. Terminal devices with alphanumeric keypads can use this to search for a specific number. Select the appropriate option from the list: no: No access to the directory is possible; internal: Access to the internal directory (stations, groups and speed-dial destinations) is possible; LDAP: Access to the directory information of the LDAP server. LDAP access must be configured via LDAP for this purpose; all: Users can choose between accessing the internal directory or the LDAP directory.</p> <p>Default value: Internal</p>
<b>Internal Phonebook via Unified Directory</b>	<p>When this flag is activated, the user can search contacts in all directories. The search/lookup requests are handled as requests to the Unified directory. When the flag is not activated, the search/lookup requests are handled locally from the system.</p> <p>Default value: Enabled</p>
<b>Switches</b>	
<b>Call timer display</b>	<p>No call charge information is displayed for outgoing external calls. For UP0/E devices with a display, the current call duration is displayed. For analog lines, time recording is started by a timer (five seconds after the end-of-dialing) and for digital trunks with CONNECT. The communication system does not support call duration display for S0 devices.</p> <p>Default value: disabled</p>
<b>DTMF closed display</b>	<p>When PIN codes are entered on system telephones with a display, only asterisks (*) are shown on the display.</p> <p>Default value: enabled</p>

Parameters	Description
<b>Display for info message</b>	Info messages are shown on the display of system telephones. Default value: enabled
<b>Outreach call number transparent</b>	If a call is forwarded to an external station, the number of the calling station is displayed at the called station. In a networked system, the option must be set in the node at which a trunk connection is activated. This feature is contingent on the explicit release of the chargeable function Clip No Screening in the CO. This flag works as a toggle with the flag Suppress station number under Routes. Default value: disabled
<b>SST with transfer option (transfer caller's number)</b>	With the flag activated, when the user selects the "Start Transfer?" menu option (while on an active call) the transfer will be executed as Single Step Transfer (no consultation call). If the user selects to make first a consultation call (e.g. "Enquiry?" option) and then transfer the new call to the held party, then the transfer will be executed as normal blind transfer (or transfer after answer). In case of Single Step Transfer the calling number is displayed at the external destination when the mobile device rings, i.e. the called party sees the calling number and not the number of the transferring party when the call is transferred by a system device. The flag "Outreach call number transparent" must be also activated. Default value: disabled IMPORTANT: If the transferred party is an external device, then the function CLIP no screening must be supported by the Network Provider and activated. Otherwise, the default DID of the system will be used from CO, or the call will be rejected from CO.

### 27.3.1.4 Basic Settings > System > DISA

Parameter Description of Tabs::

- **Edit DISA**

Parameters	Description
<b>DISA</b>	
<b>Direct inward dialing</b>	Phone number under which the DISA function can be reached from external locations. The call number may be different for external and internal use.
<b>Security mode</b>	In order to be able to use the DISA functions, the user must enter a password. With the Security mode options, one can establish whether the user must wait after entering the password or whether he/she must enter the pound symbol (#). Default value: After Timeout
<b>DISA internal</b>	
<b>Phone number</b>	DISA internal refers to usage at some other IP-networked node.
<b>Mobility Callback</b>	
<b>Direct inward dialing</b>	The authentication via password is not required if a call recognized as a mobility number is made externally to a Mobility Callback DID number. In this case, the internal dial tone is switched on directly. This requires the device of the external subscriber to transmit its phone number. This phone number is then checked against the Mobility list.

### 27.3.1.5 Basic Settings > System > Intercept/Attendant/Hotline

Parameter Description of Tabs:

- **Edit Intercept/Attendant/Hotline**

Parameters	Description
<b>Intercept Position</b>	
<b>Day/night</b>	Call number of intercept position. The intercept position can be defined separately for Day and Night. In addition, it is also possible to enter any destination when activating the night service (variable night service).
<b>Central intercept position</b>	
<b>Route</b>	Route index for the central intercept position in networked communication systems
<b>Call number</b>	Call number of the central intercept position in networked communication systems
<b>Intercept to intercept position</b>	
<b>On RNA</b>	The call follows the defined procedure for incoming calls. If the end of the table is reached and does not answer, the system checks to see whether or not intercept after timeout applies. In this case, the intercept position is called after the number of rings specified under Call Forwarding. Intercepts cannot extend beyond a hunt group. The call is forwarded to the first hunt group station and remains permanently in the hunt group.  Default value: enabled
<b>on Busy</b>	If a line is busy, the system first checks to see whether or not a waiting call can be signaled. If it is not possible to signal a waiting call (call waiting rejection or intercept criterion), then the call follows the Call Management/Call Routing procedure. If the call cannot be signaled at any station, the system checks to see whether intercept or clear-down applies (B signal to CO). If an analog telephone with call waiting rejection is busy, the call is cleared down, regardless of trunk type. In the case of DTMF direct inward dial and MSI, the call is always intercepted.  Default value: disabled
<b>On Invalid</b>	When a wrong number is dialed, the system checks to see whether intercept applies. In the case of DTMF direct dial, the call is always intercepted.  Default value: enabled
<b>On Incomplete</b>	If the dialed station number is incomplete, the intercept position is called after the preset time has elapsed. The time can be set under the Time Parameters in the "End-of-selection for incomplete dialing" field.  Default value: enabled
<b>On unanswered recall</b>	If an external call is not picked up by the B subscriber after the A subscriber implements Transfer before answering to the B subscriber, and the call is still not picked up after a recall to the A subscriber is implemented, the intercept position is called after a defined period. The time can be set under the Time Parameters in the "End-of-selection for incomplete dialing" field. If this flag is not activated, the call is cleared down after the defined period.  Default value: disabled

Parameters	Description
<b>On rejection</b>	If an internal subscriber rejects a call with "Reject incoming call", the call follows the call management / call routing. If the call cannot be signaled at any station, the system checks to see whether intercept or clear-down applies (B signal to CO).  Default value: enabled
<b>Telephone lock intercept</b>	
<b>Call number</b>	If the telephone lock for a station is active and a trunk group code is dialed from that station, the call is immediately forwarded to the intercept destination entered here. This means that if a user dials a number that is not authorized, the call will be signaled on the station number assigned here. The Codelock intercept function is set individually for each station via station flags.
<b>Attendant code</b>	
<b>Internal call number</b>	This is the call number used by internal devices to reach the Intercept position. After changing the internal call number of the attendant, a download to the IVM is triggered automatically.  Value range: Free input of any digit, provided it is not already used in the dial plan
<b>Call Number External</b>	This is the call number used by DID calls or calls from the network (CorNet-N or CorNet-NQ) to reach the Intercept position.
<b>Hotline</b>	
<b>Off-hook alarm time</b>	If a subscriber lifts the receiver, the hotline is automatically called once the off-hook alarm time has expired. However, this only happens if the subscriber does not enter any digits during this time. The off-hook alarm time is specified in seconds.
<b>Destination call number 1-6</b>	Six hotline destinations can be entered system-wide; the selection occurs per station (see Stations / Edit station parameters)
<b>Attendant Console</b>	
<b>Queued calls</b>	In the Queued Calls field, you define the maximum number of calls that can wait in the Attendant queue. If the number of stations waiting in the queue of the attendant reaches this numerical value, the calls are forwarded to a configurable overflow destination.  Value range: 1-15
<b>Wait time</b>	Here you enter the number of seconds that a call can wait in the queue. After this time has expired, the call is routed according to the call forwarding defined via the Call Management.
<b>Speed extending</b>	If this flag is set, the attendant can transfer the call to another party by entering the station number for that party. This speed call transfer can only be used when the system-wide flag <b>DTMF automatic</b> has been disabled.  Default value: disabled

Parameters	Description
<b>Extend Undialed Lines</b>	An authorized subscriber (attendant console AC) can transfer an undialed trunk to an internal subscriber who does not have sufficient direct trunk access so that this subscriber can conduct exactly one external call. After the trunk is transferred to the subscriber without sufficient direct trunk access, toll restriction takes place based on an additional direct trunk access for transferred trunks. The outgoing external call is allowed only if this additional direct trunk access is sufficient, for example, if the subscriber dials a valid number according to the denied or allowed list for transferred trunks. The subscriber must dial the seizure code on a transferred trunk. A CO call privilege can be configured in the communication system for each trunk group via a reference subscriber. The default reference subscriber is the first logical subscriber port or the attendant console. The default setting is set to unrestricted trunk access for all trunk groups.  Default value: disabled
<b>Other criteria</b>	
<b>Call waiting on Busy</b>	If this flag is activated, the "Call Waiting" feature is enabled for all stations in the communication system.  Default value: enabled
<b>Immediately camp on for attendant calls</b>	Only relevant in CorNet networked systems. If the flag is set, call waiting is only allowed when an attendant console (system A) calls station B (system B). All other stations of system A cannot reach system B via call waiting. For the stations in System B, the condition for call waiting rejection (see Station view: Flags) applies to the respective stations. If the flag is not set, all calls to busy stations in another system are switched through via call waiting, provided the station has not turned on the call waiting rejection option. This flag must be set if you want to place the calling intercept on hold immediately and enable call waiting when a station is busy. If this flag is not set, the intercept receives the busy signal and is only placed on hold after a few seconds.  Default value: disabled
<b>Override by AC</b>	If this flag is enabled, the intercept position is authorized for the "Override" feature. This enables the Attendant to override (i.e., intrude into) a call of an internal subscriber.  Default value: enabled

### 27.3.1.6 Basic Settings > System > LDAP

Parameter Description of Tabs::

- **Edit LDAP**

Parameters	Description
<b>LDAP access</b>	
<b>IP address of the LDAP server</b>	IP address of the LDAP server from which the directory information is to be retrieved.
<b>Port number for LDAP access</b>	Port number for LDAP access.  Default value: 389
<b>User name/password</b>	Under Windows Server ADS, anonymous access is not supported. In this case, enter your user name and password for the LDAP connection here.  Value range: max. 48 characters

Parameters	Description
<b>LDAP server parameters</b>	
<b>Basic DN</b>	DN = Distinguished Name, search base for the search query to the LDAP server (ASCII, 100 characters), e.g., ou=com, cn=unify, cn=de
<b>Search query</b>	Pattern for the search query to the LDAP server. The \$ character must be entered as a placeholder for the names to be found. Value range: ASCII, 50 characters Default value: cn=\$*
<b>Result attribute, Name</b>	The result attribute name supports characters from the ISO-8859-1 character set with code values in the range from 0x20 to 0x80 (ASCII characters), as well as the characters Æ, Æ, Ñ, Ñ, Ö, Ö, Ø, Ü, ß, ä, ö, ö, ü. The display of characters depends on the language setting of the station and the phone being used. Value range: ASCII, 24 characters Default value: cn
<b>Result attribute, Station number</b>	Up to 25 dialed digits (0..9, *, #) and 6 characters for formatting (+,(), spaces, -) may be returned in the result attribute Station Number. The station number must be in the canonical call number format (e.g., +49 (89) 70070) Value range: ASCII, 25 characters Default value: telephoneNumber
<b>Sort search results</b>	The search results are sorted alphabetically by name. Default value: enabled
<b>LDAP Call Number Evaluation</b>	
<b>LDAP seizure code</b>	The seizure code matches the dialed routing code. Default value: 0 (default routing code of the first route)
<b>LDAP station number prefix</b>	The prefix specified here is placed before the found call number. Value range: ASCII, 5 characters

### 27.3.1.7 Basic Settings > System > Texts

Parameter Description of Tabs::

- **Edit System Texts**

Parameters	Description
<b>Reset to default values</b>	Resets the messages and answer texts to the predefined values for a given language. A reset occurs by selecting a language from the drop-down list.
<b>Info texts</b>	Information texts are short messages that one station can send to another. The communication system supplies ten standard Info texts. Each of these standard texts can be overwritten. There are only ten possible messages available at any time. Users access this information texts via the Send Message? menu item on their system telephones. Stations with which have an alphanumeric keypad also have the option of creating their own messages; however, they can not change these default messages.  Value range: max. 24 alphanumeric characters
<b>Answer texts</b>	Short messages that are sent to callers when users are absent. Ten standard texts are available. Each of these standard texts can be overwritten. Stations with which have an alphanumeric keypad also have the option of creating their own messages; however, they can not change these default messages. For many situations, users will only need to add individual information to the existing messages. Texts with a colon give the station the opportunity to complete the message by adding a number or a date. Users access these answer texts via the Advisory Message On? menu item on their system telephones.  Value range: max. 24 alphanumeric characters

### 27.3.1.8 Basic Settings > System > Flexible Menus

Flexible menus allow you to customize the menu items shown in the service menu of system telephones. If the check box is selected in the **Masking list**, the menu item is not displayed. This setting applies system-wide to all system telephones. Hidden functions can still be activated with a code.

### 27.3.1.9 Basic Settings > System > Speed Dials

Up to 8000 directory entries can be manually created or modified. The speed dial destinations are central system speed dial numbers (SPDC). The entries in a column can be sorted by clicking on the corresponding column name.

Parameter Description of Tabs:

- **Change Speed Dial**

Parameters	Description
<b>Speed dial</b>	Number that is selected by the subscriber. Speed dial numbers must have four digits (0000–7999; use leading zeros).
<b>Phone number</b>	Dialable call number of the desired destination, i.e., a seizure code or trunk code (e.g., 0, 9, 81 or 801). Value range: max. 31 digits
<b>Name</b>	Name for the speed dial destination, as stored in the internal directory and displayed when dialing the corresponding speed dial destination. Incoming calls (with CLIP are compared to the stored speed-dialing destinations and displayed as the name of the speed-dialing destination, as long as the display parameter name or the name and calling ID is activated. Value range: max. 16 characters
<b>Search</b>	Entering a search term in the <b>Speed dial</b> , <b>Call number</b> or <b>Name</b> search fields and then pressing the return key causes all hits containing the specified search term to be displayed. For example, entering the call number 521 would display the matches +495213535 and +498967521, and entering the term co as the name would display Collins, Mcoin and Branco. Pressing the return key with nothing entered in any of the search fields causes all entries to be displayed.
<b>Buttons</b>	
<b>Apply</b>	Add new entries or edit existing entries.
<b>Undo</b>	Undo changes to existing entries (before Apply).

Parameter Description of Tabs:

- **Import/Export CSV/XML file via HTTP**

Parameters	Description
<b>Import CSV/XML file via HTTP</b>	Speed dial destinations can be imported via an XML or CSV file in UTF-8 format. Existing speed dial numbers are deleted before the import. An XML template for importing speed-dial numbers can be found under <b>Service Center &gt; Documents &gt; CSV Templates</b> .
<b>Export XML file via HTTP</b>	Speed dial destinations can be exported as an XML file in UTF-8 format. The export always includes all the records.

### 27.3.1.10 Basic Settings > System > Service Codes

Features can be enabled or disabled via the phone by using service codes. The standard service codes can be changed, provided the assignment of the codes is consistent.

In addition the two codes used on Dial Pulse telephones and ISDN devices to replace the \* (star, default: 75) and the # (pound, default: 76) keys can also be changed (substitutions).



## 27.3.1.11 Basic Settings > Gateway

Parameter Description of Tabs::

- **Edit Gateway Properties**

Parameters	Description
<b>General</b>	
<b>Customer name</b>	Freely definable name for the customer; only for informational purposes (optional) Value range: max. 15 characters
<b>Contract number</b>	Freely definable string for informational purposes only (optional) Value range: unlimited
<b>System name</b>	Freely definable name for the communication system. This string appears on the display of all system telephones. Value range: max. 24 characters
<b>Gateway Location</b>	Freely definable string to specify the physical location of the communication system. This information helps a service technician to find the communication system when physical access to the communication system is required. (optional) Value range: unlimited
<b>Contact Address</b>	Freely definable string to specify the person to be contacted if problems arise with the communication system. (optional) Value range: unlimited
<b>System Country Code</b>	Selection of the country in which the communication system is operated; changing the system country code requires a reboot, which is carried out automatically.
<b>Gateway IP address</b>	Displays the IP address of the communication system, e.g., 192.168.1.2.
<b>Gateway Subnet Mask</b>	Displays the subnet mask of the communication system, e.g., 255.255.255.0.
<b>International Prefix</b>	Entry of the prefix for international calls, e.g., 00 in Germany or 011 in the U.S.
<b>National Prefix</b>	Entry of the prefix for national calls, e.g., 0.
<b>Brand</b>	Selection of the purchased product (OpenScape Business or Octopus or FX)
<b>Gateway Location</b>	
<b>Country code</b>	Enter the country code prefix, e.g., 49 for Germany or 1 for the U.S.
<b>Local area code</b>	Enter the local area code (e.g., 89 for Munich)
<b>PABX number</b>	Specifies the PABX number (central number without station DID), e.g., 7007
<b>Network Parameters</b>	

Parameters	Description
<b>Node ID</b>	Each node in a networked system must be assigned a unique node ID. This enables the individual nodes in a networked system to be uniquely identified.  Value range: 1 to 100
<b>Internal dial tone</b>	
<b>Continuous tone</b>	If this flag is set, the internal dial tone is not a tone sequence, but a continuous tone. The internal dial tone is heard immediately on picking up the handset and before any digit has been dialed.  Default: disabled

### 27.3.1.12 Basic Settings > DynDNS > DynDNS Service

Parameter Description of Tabs::

- **Display DynDNS Configuration**
- **Edit DynDNS Configuration**

Parameters	Description
<b>Activate DynDNS</b>	The DynDNS service can be used to access the gateway from different locations without knowing the current IP address of the gateway. The DynDNS service can be enabled here.
<b>User-defined Domain</b>	Select this check box if you cannot find the DynDNS provider in the <b>Domain name</b> list.
<b>User name</b>	User name of the DynDNS account at a DynDNS provider. A new DynDNS account can be created at the Internet address <a href="http://www.dyndns.org/account/create.html">http://www.dyndns.org/account/create.html</a> , for example.
<b>Password</b>	Password of the DynDNS account at a DynDNS provider. For security reasons, only wildcards are displayed when typing the password in this field.
<b>Retype Password</b>	Repeat password of the user account with the DynDNS Service. For security reasons, only wildcards are displayed when typing the password in this field.
<b>Hostname</b>	Entry of the host name registered with the DynDNS provider without the domain name, e.g., myhost. The complete subdomain name is composed of the host name and the domain name, e.g., myhost.dyndns.org.
<b>Domain name</b>	Selection of the DynDNS provider from a list (e.g., dyndns.org) or through manual entry of the DynDNS provider (if <b>User defined Domain</b> has been enabled).

Parameters	Description
<b>Update URL</b>	<p>Here you can enter the update URL of a provider which does not appear on the list of DynDNS providers. The syntax of this URL depends on the DynDNS provider. In addition, customer-specific parameters (shown in <i>italics</i> in the example) must be supplemented.</p> <p>Example of an update URL:</p> <pre>http://www.anydns.info/ update.php?user=&lt;username&gt;&amp;password=&lt;pass&gt;&amp;host=&lt;domain&gt;&amp;ip=&lt;ip addr&gt;</pre> <p>Example of an update URL with base64-encoded authentication:</p> <pre>https://&lt;b64&gt;&lt;username&gt;:&lt;pass&gt;&lt;/b64&gt;@members.dyndns.org/nic/ update?hostname=&lt;domain&gt;&amp;myip=&lt;ipaddr&gt;&amp;wildcard=NOCHG&amp;mx=NOCHG&amp;b ackmx=NOCHG</pre> <p>&lt;b64&gt;...&lt;/b64&gt; for Base64-encoded parameters</p>
<b>Last Update</b>	Time when the DynDNS service was updated last.
<b>IP Address at DynDNS</b>	IP address at the DynDNS provider to which requests for your configured DynDNS subdomain are routed.
<b>Own dynamic IP Address</b>	Displays the current IP address of the communication system, which was assigned by the Internet Service Provider.
<b>Enable Wildcard</b>	If you enable this option, any queries to subdomains such as any.myhost.dyndns.org will be routed to myhost.dyndns.org.
<b>Mail Exchanger</b>	The Mail Exchanger (MX record) indicates in the Domain Name Service to which IP address or to which domain name E-mails for the configured DynDNS subdomain are to be sent. The specified destination address must be the address of a mail server.
<b>Backup MX</b>	If you enable this option, E-mails which are not delivered to the specified Mail Exchanger because it is temporarily not available, will be buffered by the DynDNS service and will finally be delivered once your Mail Exchanger is available again.
<b>Use HTTPS for Update</b>	If this option is enabled, the secure encrypted HTTPS connection is selected for updating.

### 27.3.1.13 Basic Settings > DynDNS > Update Timer DNS Names

Parameter Description of Tabs::

- **Edit Update Timer**

Parameters	Description
<b>Update DNS Names</b>	This option applies only to VPN. After the time interval set under "Update Timer value for DNS Names" expires, the VPN component checks whether any DNS names in the VPN configuration are resolved into new IP addresses (VPN with dynamic IP addresses). If this is the case, the VPN will be reconfigured with the new IP addresses.
<b>Update Timer value for DNS names (sec)</b>	<p>Number of seconds for the interval between two updates.</p> <p>Value range: 60 to 1800, default value: 180</p>

### 27.3.1.14 Basic Settings > Quality of Service

In the case of IP data traffic, the IP packets generated by the communication system are split into five groups. You can set which codepoint is to be used for marking the packets for four of these groups. The remaining data traffic is not prioritized (that is 00).

Priority class	ToS value, binary	ToS value, hexadecimal
<b>AF (Assured Forwarding)</b>		
AF11	001-010-00	28
AF12	001-100-00	30
AF13	001-110-00	38
AF21	010-010-00	48
AF22	010-100-00	50
AF23	010-110-00	58
AF31	011-010-00	68
AF32	011-100-00	70
AF33	011-110-00	78
AF41	100-010-00	88
AF42	100-100-00	90
AF43	100-110-00	98
<b>EF (Expedited Forwarding)</b>		
EF	101-110-00	B8
<b>Best Effort (BE)</b>		
BE	000-000-00	00
<b>CS (Class Selector)</b>		
CS3	011-000-00	60
CS4	100-000-00	80
CS5	101-000-00	A0
CS6	110-000-00	C0
CS7	111-000-00	E0
<b>Manual entry</b>	xxx-xxx-00	0-63 (decimal)

Parameter Description of Tabs:

- **Edit Quality of Service Settings**

Parameters	Description
<b>Priority Class for Signaling Data</b>	Call signaling for connection setup with H.323/SIP Default value: AF31
<b>Priority Class for Fax/Modem Payload</b>	Data Payload, for example, for IP networking with fax or modem Default value: EF
<b>Priority Class for Network Control</b>	Network Control, for example, SNMP traps Default value: CS7
<b>Priority Class for Voice Payload</b>	Voice Payload for IP telephony (Voice over IP) Default value: EF

### 27.3.1.15 Basic Settings > Date and Time > Date and Time

Parameter Description of Tabs::

- **Set Date and Time**

Parameters	Description
<b>Date and Time</b>	
<b>Day</b>	Selection of the day.
<b>Month</b>	Selection of the month.
<b>Year</b>	Entry of the year.
<b>hh:mm:ss</b>	Entry in the time in 24-hour format

### 27.3.1.16 Basic Settings > Date and Time > Timezone Settings

Parameter Description of Tabs::

- **Edit Timezone Settings**

Parameters	Description
<b>Time zone</b>	Local time zone in which the system is located

### 27.3.1.17 Basic Settings > Date and Time > SNTP Settings

Parameter Description of Tabs:

- **Edit Settings**

Parameters	Description
<b>SNTP Client</b>	
Input of access data for an external time server (SNTP) for network-wide synchronization of the system clock.	
<b>Administration Mode of the SNTP Client</b>	Enable or disable connection of the communication system to the SNTP server Default value: down
<b>IP address/DNS name of External Time Server</b>	IP address or DNS name of the SNTP server Default value: 0.de.pool.ntp.org
<b>Poll Interval for External Time Server</b>	Interval for the synchronization of the date and time with the SNTP server. Default value: 4 hours.

### 27.3.1.18 Basic Settings > Port Management

The displayed ports are used to identify the network protocols and appropriate network services. Some of the ports used by the communication system itself can be changed here. This enables the network communication to be customized for each customer network if the ports are already being used elsewhere. If changes are to be made at the port administration, these changes must generally be made in all components (phones, systems, etc.) simultaneously in order to retain functionality.

Parameter Description of Tabs::

- **Edit Global Port Management Settings**

Parameters	Description
<b>Protocol Name</b>	Service.
<b>Port Number</b>	Port number of the service (configurable).
<b>Port type</b>	The port type is displayed for information purposes; Single: a single port; Min: lower limit for a port range.
<b>Services</b>	
<b>CSP</b>	CSTA Service Provider, IP port for all applications that want to connect to the CSP. Default value: 8800
<b>HFA</b>	Control of HFA clients (CorNet-TC server port). Default value: 4060
<b>HFA_EXT</b>	Control of HFA clients (CorNet-TC server port) for System Device@Home. Default value: 4062
<b>HFA_TLS</b>	CorNet-TC via TLS. Default value: 4061
<b>HFA_TLS_EXT</b>	CorNet-TC via TLS for System Device@Home. Default value: 4063

Parameters	Description
<b>MEB_SIP</b>	MediaExtensionBridge, call signaling for SIPQ trunking. Default value: 15060
<b>RTP_MIN</b>	RTP/RTCP and T.38 ports (MediaBasePort). Default value: 29100
<b>SIP</b>	Call signaling for SIP telephones and SIP-based trunking. Default value: 5060
<b>SIP_EXT</b>	Call signaling for SIP telephones and ITSP trunking for SIP Device@Home. Default value: 5070
<b>SIPS</b>	Secure call signaling for SIPQ trunking. Default value: 5061
<b>SIP_TLS_SUB</b>	Secure call signaling for SIP stations. Default value: 5062
<b>SIP_TLS_SUB_EXT</b>	Secure call signaling for SIP stations for SIP Device@Home. Default value: 5071
<b>VSL_MULTISITE</b>	Multi-site connections. Default value: 8778

### 27.3.1.19 Basic Settings > Call Charges > Call Charges - Output Format

Parameter Description of Tabs::

- **Edit Output Format**

Parameters	Description
<b>Format of Call Records</b>	
<b>Compressed Output Format</b>	Default value: enabled
<b>Last 4 digits suppressed</b>	Replace the last 4 digits of the phone number field by question marks for privacy protection. Default value: disabled
<b>Log incoming calls</b>	Default value: disabled
<b>Call Duration</b>	Logging of call duration in hours, minutes, and seconds. Default value: enabled
<b>On Ringing</b>	For incoming calls, a call record is created immediately after the start of the call so that additional information on the caller can be transmitted for a caller list, for example or via a PC-based evaluation of the record. Default value: disabled
<b>Output MSN</b>	Logging of the used MSN (only IDSN) Default value: disabled

Parameters	Description
<b>Decimal format</b>	(Not in the USA) Format of the Advice of Charges; to be configured individually for each country. In Germany, the decimal format is always used. This decimal format also means that the multiplier is shown in hundredths. The multiplier specifies the amount by which the call charge unit is multiplied in order to obtain the currency value (e.g., 0.06 euro instead of 6 cents).  Default value: enabled
<b>Display amounts instead of units</b>	Currency amounts are output instead of call charge units (e.g., 4.50 EUR instead of 75 units).  Default value: enabled
<b>Outgoing without connection</b>	Logging of outgoing calls that were not answered.  Default value: disabled
<b>Outgoing LCR number outgoing or dialed number incoming</b>	If this flag is activated, an additional phone number field is added to the call data record. It contains: <ul style="list-style-type: none"> <li>• for an outgoing call: the LCR phone number that was actually sent to the exchange following conversion by LCR or</li> <li>• for an incoming call: the internal phone number of the station required, that is, the first station dialed.</li> </ul> A call record is then output, even if a call is made for a busy station. This call record has the same format as the data record created for a free station except that the ring/call duration is set to "0".  Default value: disabled
<b>Call Detail Recording Central (CDRC)</b>	
<b>Output : none</b>	No transmission of connection data  Default value: HTTP
<b>Output: HTTPS</b>	Transmission of connection data to the supplied Call Charge Manager (Accounting Manager) or some other accounting software  Default value: HTTP
<b>Output : LAN TCP Client</b>	Transmission of connection data to external server via TCP/IP  Default value: HTTP
<b>TCP client</b>	Set IP address and port number of an external call charge server. If call charges have been incurred, a TCP/IP connection to the external call charge server (external application) is initiated by the communication system. When the connection has been set up, the call charge data is transmitted. The connection remains permanently open, and any other charges that occur are transmitted. transmitting each data record separately.

### 27.3.1.20 Basic Settings > Call Charges > Call Charges - Factors

Parameter Description of Tabs::

- **Edit Factors**



Parameters	Description
<b>Call charge factor per direction</b>	The call charge information can be offered in the form of call charge units (pulse counts) or currency units (cash amounts). Both forms are supported, but only currency units are displayed. If the information is received in the form of call charge units, a conversion factor is used. These call charge factors are set fees per direction and apply to both trunk calls (outside calls) as well as incoming and outgoing calls in the internetwork.
<b>Routes</b>	Displays the existing routes in the system
<b>Multiplier</b>	This multiplier is used for the conversion of tariff units to currency amounts. Value range: 0 to 65534, default value: 6
<b>Multi-ISDN</b>	Factor for converting currency amounts received or of Originals-based unit, and vice versa. Only for routes with the QSIG protocol. Value range: 1 to 65535, default value: 6
<b>Currency</b>	Abbreviation of the currency, e.g., EUR. This must be adjusted in line with the connected communication system. Currency string configuration is independent of the currency string shown on the telephone display. Note: This parameter is only significant for routes that use the QSIG protocol. This parameter is not applied for other protocols. The preset default setting must be retained in such cases. Value range: max. 3 characters
<b>charges</b>	You can use the charges column to define whether currency charges or call charge units are exchanged on the trunk. If this option is activated, the currency amount is sent and received (see the column Multi-ISDN). Otherwise, call charge units are sent and received. This must be adjusted in line with the connected communication system. If call charge pulses are to be exchanged on the route, an empty string should be configured as the currency. Note: This parameter is only significant for routes that use the QSIG protocol. This parameter is not applied for other protocols. The preset default setting must be retained in such cases.
<b>Advice of charge: No charges</b>	No charges are received via the route (e.g., US CO trunks). The parameter is not relevant for routes with the QSIG protocol.
<b>Advice of charge: Interim</b>	Charges are only received while the connection is active, and not during cleardown.
<b>Advice of charge: Final</b>	Charges are only received after the connection has been cleared down.
<b>Advice of charge: Interim/Final</b>	Charges are received while a connection is active and during connection cleardown.
<b>Currency</b>	Currency code for the call charge display on telephones.
<b>Computing accuracy</b>	The computing accuracy of the communication system should be set to at least match that of the currency amounts transmitted by the CO. If the maximum of three decimal places is insufficient, the system automatically rounds up the number to the next unit. "Via call charge pulse" must be selected for routes with the QSIG protocol.

### 27.3.1.21 Basic Settings > Call Charges > Call Charges - Account Codes

Parameter Description of Tabs::

- **Change Account Codes**

Parameters	Description
<b>Checking procedure</b>	
<b>Checking procedure: No check</b>	The entered account codes are not checked. This option is not possible if there are routes with a mandatory entry procedure.
<b>Checking procedure : List check</b>	The entered account codes are checked for validity based on account code lists.
<b>Checking procedure : Check number of characters</b>	The entered account codes are checked for the number of characters.
<b>Characters to be checked</b>	Valid number of characters for the account code. Value range: 1 to 11, default value: 5
<b>Account code lists</b>	
<b>List</b>	A maximum of 1000 account codes can be entered for the list check.
<b>Account code</b>	Value range: max. 11 digits

### 27.3.1.22 Basic Settings > Announcement Player for Voicemails/Announcements

Parameter Description of Tabs:

- **Change announcement player for voicemails/announcements**

Parameters	Description
<b>Voicemail</b>	
<b>Prefix</b>	Call number for the voicemail box.
<b>Announcement Player</b>	
<b>Call number</b>	Call number of the announcement player.

### 27.3.1.23 Basic Settings > Phone Parameter Deployment

Parameter Description of Tabs:

- **Change phone parameter settings**

Parameters	Description
<b>Phone Parameter Deployment</b>	
<p>The following prerequisites must be satisfied for this parameter to be effective: the system telephones must use the DLI of the system, and the DLI must be able to supply the system telephones with the required parameters. The parameters of the system telephones are updated as soon as a system phone reconnects to the system or is restarted, or whenever the system is rebooted.</p> <p>The individual parameters can be configured directly at the system telephone or with the WBM of the system telephone. The settings for the PC Ethernet port and for the codec prioritization are not overwritten by the DLI if they were configured directly at the system telephone or with the WBM of the system telephone.</p>	
<b>PC port mode</b>	<p>If this flag is enabled, the PC Ethernet port is switched on at all active system telephones.</p> <p>Default: disabled</p>
<b>Codec setting is "low bandwidth preferred"</b>	<p>If this flag is enabled, the following codec prioritization applies to all system telephones: G.729 - G.711 - G.722</p> <p>If this flag is disabled, the following codec prioritization applies: G.722 - G.711 - G.729</p> <p>Default: disabled</p>
<b>Display calling party images</b>	<p>If this flag is enabled, the caller's image appears on system telephones with a large color display on receiving an incoming call, provided the image was loaded into the system via UC Smart or UC Suite.</p> <p>Default: disabled</p>
<b>Apply phone parameter settings to all phones</b>	<p>If this flag is enabled, all local administered settings are overwritten.</p> <p>Default: disabled</p>

### 27.3.1.24 Basic Settings > Power Management

Parameter Description of Tabs:

- **Power management on/off**

Parameters	Description
<b>Power Management</b>	
<p>Power management can be enabled only if is the LAN interfaces of the system are in the Ethernet Link Mode <b>Auto</b>. In the low power mode, the LAN interfaces of the system automatically switch to the 100 Mbit/s full-duplex mode. The LAN interfaces of the connected infrastructure should also be in the autosense mode.</p>	
<b>Power management on/off</b>	Switches the system to the low power mode.
<b>Beginning of the low power mode</b>	Start time of the low power mode
<b>End of the low power mode</b>	End time of the low power mode.
<b>The IP bandwidth is reduced to 100 Mbit/s FDX</b>	Displays the data rate in low power mode

### 27.3.1.25 Basic setting > Mass Data

- Parameter Description of Tabs:

Parameter	Description
<b>Port</b>	Port number. Not editable field.
<b>Validity</b>	There are two types of validation, the Front End Consistency Check and the Back End Consistency Check: a. The <b>Front End Consistency Check</b> validates data presented in the fields of Mass data wizard window by checking for inconsistencies and conflicts. An instant red indication is displayed in the Validity field under the respective numbers. On mouse over a pop up window indicates which is the exact conflict. b. The <b>Back End Consistency Check</b> validates data presented in the Mass Data wizard comparing them to data that are not viewable but exist in the database of the system. These include Group, MULAP, Voicemail, National and International Access, VSL numbers, Seizure Codes and Line Codes (i.e. trunk access).
<b>Callno</b>	Internal call number of the station.
<b>DID</b>	DID number of the station.
<b>Display</b>	Freely selectable name for the station.  By default, it is created using the First Name and Last Name parameters depending on display name algorithm.
<b>First Name</b>	Freely selectable first name for the station.
<b>Last Name</b>	Freely selectable last name for the station.
<b>Device Type</b>	The device type assigned to the user. Not editable field.
<b>Type</b>	Type of the station.
<b>Type: No Port</b>	Call number is not yet assigned to any station.
<b>Type: System Client</b>	A system client is an IP station that can use all the features of the communication system via CorNet-IP (formerly called HFA system client).
<b>Type: SIP Client</b>	A SIP client is an IP station that uses the SIP protocol. It can access only limited functionality of the communication system via SIP.
<b>Type: Deskshare User</b>	A Deskshare User is an IP user who can log in at another IP system telephone (mobile login) and then use this phone as his or her own phone (including the call number).
<b>Fax Callno</b>	If a fax box has been set up (e.g., with the UC clients myPortal for Desktop or myPortal for Outlook), the fax number at which fax messages from internal locations can be received by the subscriber should be entered here.
<b>Fax DID</b>	If a fax box has been set up (e.g., with the UC clients myPortal for Desktop or myPortal for Outlook), the fax number at which fax messages from external locations can be received by the subscriber should be entered here.
<b>Access</b>	Displays the physical interface at which the device is connected.
<b>Clip/Lin</b>	Sequence of digits to be displayed at the called party instead of the actual number for outgoing external calls (e.g., for E911 emergency services in the USA)
<b>Status</b>	Displays the status of the device. Active or inactive.

## 27.3.2 Security

Security settings are grouped together under **Security**. These include settings for firewalls, filters, VPN, and SSL.

### 27.3.2.1 Security > Application Firewall

Parameter Description of Tabs:

- **Display Services**
- **Add Service**
- **Delete all Services**

Parameters	Description
<b>Application Firewall</b>	<p>The Application Firewall is used to restrict access to specific services such as FTP or LDAP. It is disabled by default and can be enabled by defining appropriate rules. The following services can either be blocked or restricted to specific IP addresses or IP address ranges by the Application Firewall:</p> <p><b>Service / Ports</b></p> <p>HTTPS / 443</p> <p>Postgres / 5432</p> <p>OpenScope Observer / 8808</p> <p>LDAP / 389</p> <p>Manager E / 7000</p> <p>ssh (locked by default) / 22</p> <p>FTP / 21, 40000 - 40040</p> <p>Only the listed services can be blocked via a selection menu in Expert mode. Telephone features such as SIP, HFA, etc. cannot be blocked using the Application Firewall. A service can be selected multiple times; each time, different IP restrictions can be specified.</p>
<b>Rule Name</b>	Given name for the rule
<b>Rule activated</b>	The rule is activated.
<b>Lower Limit of Source IP Address Range</b>	The lower limit of the blocked IP addresses.
<b>Upper Limit of Source IP Address Range</b>	The upper limit of the blocked IP addresses.

### 27.3.2.2 Security > Deployment and Licensing Client (DLSC)

To use DLS functions, for example, the communication system must allow the external DLS to access the configuration data. The communication system is then operated as Deployment and Licensing Client. The external DLS server is set up under > Mainboard > DHCP Mode > DHCP Server > Global Settings.

Parameter Description of Tabs::

- **DLSC Basic Configuration**
- **Contact DLSC**
- **Reset DLSC Bootstrapping**

Parameters	Description
<b>Status</b>	
<b>Secure Communication with DLS Client</b>	Indicates whether (and to what extent) secure communication with the DLS client is enabled or disabled (0).
<b>DLS Client</b>	
<b>Time interval for ContactMe Response</b>	Default value: 0
<b>PIN required for DLS Bootstrapping</b>	Enhanced level of security via PIN entry on both sides
<b>Bootstrap PIN</b>	Value range: min. 8 to max. 32 characters
<b>DLS Server</b>	
<b>IP address of DLS server</b>	Input of the IP address of the external DLS server.
<b>Port of DLS Server</b>	Port of the external DLS Server Default value: 18443
<b>Secure Port of DLS Server</b>	Display the port number for a secure connection

### 27.3.2.3 Security > Deployment and Licensing Client (DLSC) > DLSC Client Certificate

Parameter Description of Tabs:

- **Certificate Information**

Parameters	Description
<b>Certificate Type</b>	Used to ensure secure initial contact between the communication system and the DLS
<b>Serial Number of Certificate</b>	Displays the specified serial number.
<b>Serial Number of Certificate (hex)</b>	Displays the specified serial number in hexadecimal form.
<b>Type of Signature Algorithm</b>	Displays the signature algorithm used Value range: sha256RSA, sha512RSA
<b>Start Time of Validity Period (GMT)</b>	Displays the start of the certificate validity period. The time specified is interpreted as Greenwich Mean Time (GMT).
<b>End Time of Validity Period (GMT)</b>	Displays the end of the certificate validity period. The time specified is interpreted as Greenwich Mean Time (GMT).
<b>CRL distribution point</b>	Displays the optional URL from where the Certificate Revocation Lists (CRL) will be distributed

Parameters	Description
<b>Issued by CA</b>	The Certification Authority that has signed the certificate
<b>Country (C)</b>	Two-digit country code
<b>Organization (O)</b>	The full legal company name
<b>Organization Unit (OU)</b>	The Organizational Unit is whichever branch of the company is ordering the certificate
<b>Common Name (CN)</b>	Fully Qualified Domain Name (FQDN)
<b>Subject Name</b>	Displays the name of the subject who requested the certificate according to the conventions of the X.509 standard (for example, enter DE for Germany in the Country (C) field)
<b>Country (C)</b>	Two-digit country code
<b>Organization (O)</b>	The full legal company name
<b>Organization Unit (OU)</b>	The Organizational Unit is whichever branch of the company is ordering the certificate
<b>Common Name (CN)</b>	Fully Qualified Domain Name (FQDN)
<b>Alternative Subject Name</b>	This optional information distinguishes between the Distinguished Name Format (such as the data under Subject Name) and Other Format (for example, the IP address entry). The input mask depends on the selected format
<b>Public Key Encryption Data</b>	Public key data of certificate used for encryption
<b>Public Key Length</b>	Value range: 1024, 1536, 2048
<b>Public Key</b>	Encryption using public keys that are confirmed by a third party in accordance with the X.509 standard. The high level of security is guaranteed by the fact that the decryption key must be individually redefined and is only saved at the user's facility.
<b>Fingerprint</b>	The public key used and the fingerprint are displayed in hexadecimal format.

### 27.3.2.4 Security > Deployment and Licensing Client (DLSC) > DLSC CA Certificate

Parameter Description of Tabs:

- **Certificate Information**

Parameters	Description
<b>Certificate Type</b>	Used to ensure secure initial contact between the communication system and the DLS.
<b>Serial Number of Certificate</b>	Displays the specified serial number.
<b>Serial Number of Certificate (hex)</b>	Displays the specified serial number in hexadecimal form.
<b>Type of Signature Algorithm</b>	Displays the signature algorithm used. Value range: sha256RSA, sha512RSA
<b>Start Time of Validity Period (GMT)</b>	Displays the start of the certificate validity period. The time specified is interpreted as Greenwich Mean Time (GMT).
<b>End Time of Validity Period (GMT)</b>	Displays the end of the certificate validity period. The time specified is interpreted as Greenwich Mean Time (GMT).

Parameters	Description
<b>CRL distribution point</b>	Displays the optional URL from where the Certificate Revocation Lists (CRL) will be distributed.
<b>Issued by CA</b>	The Certification Authority that has signed the certificate
<b>Country (C)</b>	Two-digit country code
<b>Organization (O)</b>	The full legal company name
<b>Organization Unit (OU)</b>	The Organizational Unit is whichever branch of the company is ordering the certificate
<b>Common Name (CN)</b>	Fully Qualified Domain Name (FQDN)
<b>Subject Name</b>	Displays the name of the subject who requested the certificate according to the conventions of the X.509 standard (for example, enter DE for Germany in the Country (C) field).
<b>Country (C)</b>	Two-digit country code
<b>Organization (O)</b>	The full legal company name
<b>Organization Unit (OU)</b>	The Organizational Unit is whichever branch of the company is ordering the certificate
<b>Common Name (CN)</b>	Fully Qualified Domain Name (FQDN)
<b>Alternative Subject Name</b>	This optional information distinguishes between the Distinguished Name Format (such as the data under Subject Name) and Other Format (for example, the IP address entry). The input mask depends on the selected format.
<b>Public Key Encryption Data</b>	Public key data of certificate used for encryption
<b>Public Key Length</b>	Value range: 1024, 1536, 2048
<b>Public Key</b>	Encryption using public keys that are confirmed by a third party in accordance with the X.509 standard. The high level of security is guaranteed by the fact that the decryption key must be individually redefined and is only saved at the user's facility.
<b>Fingerprint</b>	The public key used and the fingerprint are displayed in hexadecimal format.
<b>Certificate Type</b>	Used to ensure secure initial contact between the communication system and the DLS.

### 27.3.2.5 Security > Signaling and Payload Encryption

Parameter Description of Tabs:

- **Edit Security Configuration**



Parameters	Description
<b>Minimum length of the RSA key:</b>	Minimum length of the RSA key in the certificates. The higher the value, the more secure the key  Value range: 512, 1024, 2048 Default: 1024
<b>Certificate validation</b>	Switches the certificate validation on or off completely. We recommend that you do not switch off the certificate validation.  Default: on
<b>Subject name check</b>	By checking the subject name in the certificate of a gateway, its identity can be checked. The subject name contains the IP address or the DNS name (DNS: Domain Name System) of the respective gateway  Default: disabled
<b>CRL verification</b>	Using a Certificate Revocation List (CRL), it is possible to determine whether a certificate was blocked/revoked and why. When a Certification Authority (CA) declares a certificate to be invalid, it enters the serial number of that certificate in its list. During certificate validation, this list can be checked at the Certification Authority via the Internet.  Default: disabled
<b>Enforce Secure Renegotiation (RFC 5746)</b>	This procedure improves security during the renegotiation of the encryption parameters for TLS connections. It can only be used provided it is supported on all connected servers. (OpenScape Business, OpenScape 4000 and OpenScape Voice support this improved procedure; HiPath 3000 does not).  Default: disabled
<b>Maximum Re-Keying interval (hours)</b>	This interval determines how long a specific key is to be used for the encryption of signaling and user data. After this period expires, a new key is defined.  Value range: 6 to 48 Default: 24

### 27.3.2.6 Security > Signaling Encryption/Payload Encryption > SPE Certificate

Parameter Description of the Tab:

- **Import SPE certificate plus private key (PKCS#12 file)**

Parameters	Description
<b>Passphrase for decryption</b>	Input of the passphrase that was used when creating the PKCS#12 file.
<b>File with certificate and private Key (PEM or PKCS#12 format)</b>	Selection of the file containing the certificate data to be imported.

### 27.3.2.7 Security > Signaling Encryption/Payload Encryption > SPE CA Certificates

Up to 16 trusted CA certificates can be imported individually from a client PKI certificate authority (RA/CA), for example.

Parameter Description of the Tab:

- **Import trusted CA Certificate (X.509 file) for SPE**

Parameters	Description
<b>File with certificate (PEM or binary)</b>	Selection of the PEM or binary file to be imported.
<b>CRL Distribution Point (CDP) Protocol</b>	Protocol selection for the CRLs (certificate revocation lists) Value range: LDAP or HTTP
<b>CDP (e.g., without ldap://)</b>	A CDP is an optional certificate extension. An imported certificate is only checked against the CRLs for which the CDP was configured.

### 27.3.2.8 Security > VPN

Parameter Description of Tabs:

- **Display General Information**
- **Activate the Configured VPN Tables**
- **IPsec on / off**

Parameters	Description
<b>Encryption Algorithms</b>	Used encryption algorithms Value range: AES, 3DES
<b>Hash Algorithms</b>	Standardized cryptographic hash function used to compute a unique check value (digital signature) Value range: MD5, SHA1, SHA2
<b>Public Key Algorithms</b>	Asymmetric encryption method Value range: RSA
<b>Diffie-Hellman Groups</b>	A method for exchanging keys Value range: DH Group 2, DH Group 5
<b>Buttons</b>	
<b>Activate Now</b>	The VPN tables can be activated. Observe the warnings!
<b>Activate/Deactivate IPsec</b>	IPSec can be enabled or disabled. Observe the warnings!

### 27.3.2.9 Security > VPN > Lightweight CA

Parameter Description of Tabs:

- **Generate CA Certificate**

Parameters	Description
<b>Name of the Certificate</b>	Freely definable flat name for the generated certificate
<b>Serial Number of Certificate</b>	Input of a serial number that you specify. This number must be a positive integer.
<b>Type of Signature Algorithm</b>	Selection of the signature algorithm to be used for this certificate Value range: sha25RSA, sha512RSA
<b>Public key length</b>	Selection of a key length used for this certificate Value range: 2048
<b>Start Time of Validity Period (GMT)</b>	
Point of time as of which the certificate should be valid. The time specified is interpreted as Greenwich Mean Time (GMT).	
<b>End Time of Validity Period (GMT)</b>	
Point of time until which the certificate should be valid. The time specified is interpreted as Greenwich Mean Time (GMT).	
<b>Subject Name</b>	
Input of the subject name data of the certificate applicant according to the conventions of the X.509 standard (e.g., DE for Germany in the Country (C) field).	
<b>Alternative Subject Name</b>	
This optional information distinguishes between the Distinguished Name Format (such as the data under Subject Name) and some other format (for example, the IP address entry). The input mask depends on the selected format. If other format is selected, more than one SAN entries is possible to be configured..	
<b>Distinguished Name Format</b>	This is usually also provided as the Common Name RDN within the Subject field of the main certificate
<b>Other Format</b>	Other names, given as a General Name
<b>Subject Alternative Name Extension</b>	Value range: DNS Name, IP Address, E-mail Address, Uniform Resource Indicator, Other
<b>Alternative Subject Name</b>	This optional information distinguishes between the Distinguished Name Format (such as the data under Subject Name) and Other Format (for example, the IP address entry). The input mask depends on the selected format. If other format is selected, more than one SAN entries is possible to be configured..
<b>CRL Distribution Point Type</b>	Value range: DNS Name, IP Address, E-mail Address, Uniform Resource Indicator, Other
<b>CRL Distribution Point</b>	Specification of a URL from where the Certificate Revocation Lists (CRL) will be distributed.
<b>Generate Certificate</b>	

### 27.3.2.10 Security > VPN > Certificate Management

Parameter Description of Tabs::

- **View Certificate From File**

Parameters	Description
<b>PKCS#12 Format</b>	You must activate this field if the certificate is saved in a PKCS#12 file.
<b>Passphrase for decryption</b>	If you activate the PKCS#12 Format field, you must enter the same password in this field as used for file creation.
<b>File with Certificate</b>	Enter the path and the file name of the certificate in this field. Click on Browse if you are unsure of the storage location. A search dialog is displayed.

### 27.3.2.11 Security > VPN > Certificate Management > Trusted CA Certificates > Active Certificates

Parameter Description of the Tab:

- **Import Trusted CA Certificate (X.509)**

Parameters	Description
<b>Certificate Type</b>	Used to ensure secure initial contact between the communication system and the DLS
<b>Serial Number of Certificate</b>	Displays the specified serial number.
<b>Serial Number of Certificate (hex)</b>	Displays the specified serial number in hexademical form.
<b>Type of Signature Algorithm</b>	Displays the signature algorithm used Value range: sha256RSA, sha512RSA
<b>Start Time of Validity Period (GMT)</b>	Displays the start of the certificate validity period. The time specified is interpreted as Greenwich Mean Time (GMT).
<b>End Time of Validity Period (GMT)</b>	Displays the end of the certificate validity period. The time specified is interpreted as Greenwich Mean Time (GMT).
<b>CRL distribution point</b>	Displays the optional URL from where the Certificate Revocation Lists (CRL) will be distributed
<b>Issued by CA</b>	
<b>Country (C)</b>	
<b>Organization (O)</b>	
<b>Organization Unit (OU)</b>	
<b>Common Name (CN)</b>	
<b>Subject Name</b>	Displays the name of the subject who requested the certificate according to the conventions of the X.509 standard (for example, enter DE for Germany in the Country (C) field)
<b>Country (C)</b>	
<b>Organization (O)</b>	
<b>Organization Unit (OU)</b>	

Parameters	Description
<b>Common Name (CN)</b>	
<b>Alternative Subject Name</b>	This optional information distinguishes between the Distinguished Name Format (such as the data under Subject Name) and Other Format (for example, the IP address entry). The input mask depends on the selected format
<b>Public Key Encryption Data</b>	
<b>Public Key Length</b>	Value range: 1024, 1536, 2048
<b>Public Key</b>	Encryption using public keys that are confirmed by a third party in accordance with the X.509 standard. The high level of security is guaranteed by the fact that the decryption key must be individually redefined and is only saved at the user's facility.
<b>Fingerprint</b>	The public key used and the fingerprint are displayed in hexadecimal format.

### 27.3.2.12 Security > VPN > Certificate Management > Trusted CA Certificates > Configured Certificates

Parameter Description of the Tab:

- **Import Trusted CA Certificate (X.509)**

Parameters	Description
<b>Name of the Certificate</b>	Enter the name to be assigned to the certificate.
<b>File with Certificate</b>	Path and file name of the certificate. When you click Browse, a search dialog is displayed to find the storage location of the file.

### 27.3.2.13 Security > VPN > Peer Certificates

Parameter Description of Tabs:

- **Generate Certificate Signing Request (CSR)**
- **Import Peer Certificate (PKCS#12)**

Parameters	Description
<b>Certificate Request Name</b>	A CA-signed peer certificate based on a CA certificate can be generated. This requires at least one CA certificate to have already been generated. The certificate generated is saved in a PKCS#12 file. PKCS#12 files (Personal Information Exchange Syntax Standard) save certificates with the private key. A PKCS#12 file therefore contains the necessary data for personal encryption and decryption.
<b>Type of Signature Algorithm</b>	Select the signature algorithm to be used for this certificate. Value range: sha25RSA, sha512RSA
<b>Public key length</b>	Value range: 2048
<b>Subject Name</b>	Subject name data of the certificate applicant according to the conventions of the X.509 standard (e.g., DE for Germany in the Country (C) field).
<b>Country (C)</b>	Two-digit country code
<b>Organization (O)</b>	The full legal company name
<b>Organization Unit (OU)</b>	The Organizational Unit is whichever branch of the company is ordering the certificate
<b>Common Name (CN)</b>	Fully Qualified Domain Name (FQDN)
<b>Alternative Subject Name</b>	This optional information distinguishes between the Distinguished Name Format (such as the data under Subject Name) and Other Format (for example, the IP address entry). The input mask depends on the selected format. If other format is selected, more than one SAN entries is possible to be configured..
<b>Distinguished Name Format</b>	This is usually also provided as the Common Name RDN within the Subject field of the main certificate
<b>Country (C)</b>	Two-digit country code
<b>Organization (O)</b>	The full legal company name
<b>Organization Unit (OU)</b>	The Organizational Unit is whichever branch of the company is ordering the certificate
<b>Common Name (CN)</b>	Fully Qualified Domain Name (FQDN)
<b>Other Format</b>	Other names, given as a General Name
<b>Subject Alternative Name Extension</b>	Value range: DNS Name, IP Address, E-mail Address, Uniform Resource Indicator, Other
<b>Subject Alternative Name</b>	This optional information distinguishes between the Distinguished Name Format (such as the data under Subject Name) and Other Format (for example, the IP address entry). The input mask depends on the selected format.
<b>Import Peer Certificate [PKCS#12]</b>	
<b>Name of the Certificate</b>	Enter the name to be assigned to the certificate.
<b>Passphrase for decryption</b>	Password to decrypt the peer certificate Value range: min. 7 and max. 32 characters
<b>File with Certificate</b>	Click on Browse. A search dialog is displayed.
<b>View Fingerprint of Certificate</b>	Click on this button to check the integrity of the certificate.
<b>Import Certificate from File</b>	Click on this button to import a certificate.

### 27.3.2.14 Security > VPN > Services > Active Services

Parameter Description of the Tab:

- **Display IPsec Services**

Parameters	Description
<b>Name of the Service</b>	This field contains the name of the configured services.
<b>State in IP Stack</b>	
<b>Source Port</b>	Displays the source port number. If "0" is displayed as the port, this corresponds to any (unknown) port.
<b>Destination Port</b>	Displays the destination port number. If "0" is displayed as the port, this corresponds to any (unknown) port.
<b>IP protocol</b>	Displays the IP protocol used for the transmission.
<b>Associated 'pass' Rule</b>	Displays the associated "Pass" rule. The assignment of rules and services is performed under Rules.
<b>Associated 'deny' Rule</b>	Displays the associated "Deny" rule. The assignment of rules and services is performed under Rules.

### 27.3.2.15 Security > VPN > Services > Configured Services

Parameter Description of Tabs::

- **Display IPsec Services**
- **Add IPsec Services**
- **Edit IPsec Services**
- **Rename IPsec Services**
- **Delete IPsec Services**

Parameters	Description
<b>Name of the Service</b>	Input field for the name of the newly configured service. Enter a character string in this field.
<b>Source Port</b>	Number of the port to be used for the transmission of data on the transmit side. In this field, "0" indicates any (unknown) port.
<b>Destination Port</b>	Number of the port to be used for the transmission of data on the receive side. In this field, "0" indicates any (unknown) port.
<b>IP protocol</b>	IP protocol to be used for the transmission Value range: ICMP, TCP, UDP
<b>Name of the Service</b>	Input field for the name of the service to be configured.
<b>Source Port</b>	Number of the port to be used for the transmission of data on the transmit side. In this field, "0" indicates any (unknown) port.

Parameters	Description
<b>Destination Port</b>	Number of the port to be used for the transmission of data on the receive side. In this field, "0" indicates any (unknown) port.
<b>IP protocol</b>	Select the IP protocol used for the transmission Value range: ICMP, TCP, UDP
<b>Name of the Service</b>	Input field for the name of the service to be configured.
	Deletion is only possible if no rule is assigned to the service.

### 27.3.2.16 Security > VPN > Tunnels > Active Tunnels

Parameter Description of Tabs::

- **Display General Tunnel Data**
- **Display Rules for all Tunnels**

Parameters	Description
<b>Name of the Tunnel</b>	This field contains the name of the configured tunnel.
<b>State in IP Stack</b>	Status indicator in the IP stack. Value range: active / not active
<b>Type of the Local Tunnel Endpoint</b>	Displays the endpoint address at the sending end of the tunnel; you can specify a host name or a DNS name).
<b>Local Tunnel Endpoint Address</b>	Displays the endpoint address in the local tunnel.
<b>Type of the Remote Tunnel Endpoint</b>	Displays the endpoint type of the remote tunnel.
<b>Remote Tunnel Endpoint Address</b>	Displays the recipient address of the remote tunnel. If the address of 0.0.0.0 is displayed, this means that the tunnel endpoint is unknown. In this case, the tunnel must be configured by the peer (e.g. teleworker).
<b>Suggested Lifetime of the Session Keys</b>	Displays the accepted validity period for the session keys which will be used. When this period expires, no more data is exchanged within this session. New session keys are automatically negotiated to replace invalid session keys.
<b>Suggested Lifetime of the Key Exchange Session</b>	Displays the accepted validity period for the key exchange session. Once the key exchange session has expired, new keys are automatically negotiated for it using the IKE protocol (encryption protocol).
<b>Associated Rules: Associated Transmit Rule</b>	Setup of Send Rules under VPN > Rules
<b>Associated Rules: Associated Receive Rule</b>	Setup of Receive Rules under VPN > Rules
<b>Tunnel Data</b>	
<b>Name of the Tunnel</b>	This field contains the name of the configured tunnel.
<b>State in IP Stack</b>	Status indicator in the IP stack. Value range: active / not active



Parameters	Description
<b>Type of the Local Tunnel Endpoint</b>	Displays the endpoint address at the sending end of the tunnel; you can specify a host name or a DNS name).
<b>Local Tunnel Endpoint Address</b>	Displays the endpoint address in the local tunnel.
<b>Type of the Remote Tunnel Endpoint</b>	Displays the endpoint type of the remote tunnel.
<b>Remote Tunnel Endpoint Address</b>	Displays the recipient address of the remote tunnel. If the address of 0.0.0.0 is displayed, this means that the tunnel endpoint is unknown. In this case, the tunnel must be configured by the peer (e.g. teleworker).
<b>Rule Data</b>	
<b>Destination</b>	Status indicator in the Destination. Value range: send/ receive
<b>Priority</b>	Displays the priority for the processing sequence. The highest priority is specified with 1. Each rule associated with a direction must be assigned its own priority. A rule and the associated opposite-direction rule must always have the same priority. The rule for the opposite direction can only be created with the corresponding menu item.
<b>Rule-Based Action</b>	Displays how the IP packets are to be handled by the rule: "pass" means that IP packets are forwarded; "deny" means that no IP packets are forwarded.
<b>Encryption Required</b>	Displays an encryption for this rule. The encryption procedure is defined by the assigned tunnel.
<b>Rule State</b>	Status indicator in the rule. Value range: enabled/ disabled
<b>State in IP Stack</b>	Status indicator in the IP stack. Value range: active / not active
<b>Source Address</b>	
Displays the source and destination address in a format suitable for the selected type. The display depends on the selected address type. If any IP address is to be used, 0.0.0.0 is displayed. NAT must be deactivated at the interface to the destination network if 0.0.0.0 is specified as the destination IP address for transmitting packets in a tunnel. Alternatively, you can specify an IP address between 0.0.0.1 and 255.255.255.254 to transmit packets in a tunnel.	
<b>Type</b>	Displays the type of the source address and destination address (possible values are: host, subnet, IP address range and DNS name).
<b>Address (Lowest in Range)</b>	Displays the source and destination address in a format suitable for the selected type. The input mask depends on the address type selected. If any IP address is to be used, 0.0.0.0 is displayed. NAT must be deactivated at the interface to the destination network if 0.0.0.0 is specified as the destination IP address for transmitting packets in a tunnel. Alternatively, you can specify an IP address between 0.0.0.1 and 255.255.255.254 to transmit packets in a tunnel.
<b>Subnet Mask / Highest Addr. in Range</b>	It is set in case that a range of source/destination addresses need to be set for transmission
<b>Destination Address</b>	
<b>Type</b>	Displays the type of the source address and destination address (possible values are: host, subnet, IP address range and DNS name).

Parameters	Description
<b>Address (Lowest in Range)</b>	Displays the source and destination address in a format suitable for the selected type. The input mask depends on the address type selected. If any IP address is to be used, 0.0.0.0 is displayed. NAT must be deactivated at the interface to the destination network if 0.0.0.0 is specified as the destination IP address for transmitting packets in a tunnel. Alternatively, you can specify an IP address between 0.0.0.1 and 255.255.255.254 to transmit packets in a tunnel.
<b>Subnet Mask / Highest Addr. in Range</b>	It is set in case that a range of source/destination addresses need to be set for transmission
<b>Service Data</b>	
Displays the service to which the encryption is restricted. If the encryption is not to be restricted to one service, select "Any Service"	
<b>Name of the Service</b>	Input field for the name of the service to be configured.
<b>Source Port</b>	Displays the tunnel in the receive direction, to which this rule applies. IP packets received by the network are retrieved from this tunnel. Select No Tunnel Assignment if no tunnel is to be assigned in the receive direction.
<b>Destination Port</b>	Displays the tunnel in the send direction, to which this rule applies. IP packets destined for the network are sent through this tunnel. Select No Tunnel Assignment if no tunnel is to be assigned in the send direction.
<b>IP protocol</b>	Select the IP protocol used for the transmission Value range: ICMP, TCP, UDP

### 27.3.2.17 Security > VPN > Tunnels > Configured Tunnels

Parameter Description of Tabs::

- **Display General Tunnel Data**
- **Display Rules for all Tunnels**
- **Add Tunnel / Edit Tunnel Data**
- **Key exchange data**

Parameters	Description
	Tunnel is the term used to describe the transportation of encrypted data packets to a defined endpoint. Active tunnels become configured tunnels when the configuration is enabled. A maximum of 256 tunnels can be set up per gateway.
<b>Name of the Tunnel</b>	This field contains the name of the configured tunnel.
<b>State in IP Stack</b>	Status indicator in the IP stack. Value range: active / not active
<b>Type of the Local Tunnel Endpoint</b>	Displays the endpoint address at the sending end of the tunnel; you can specify a host name or a DNS name).
<b>Local Tunnel Endpoint Address</b>	Displays the endpoint address in the local tunnel.
<b>Type of the Remote Tunnel Endpoint</b>	Displays the endpoint type of the remote tunnel.

Parameters	Description
<b>Remote Tunnel Endpoint Address</b>	Displays the recipient address of the remote tunnel. If the address of 0.0.0.0 is displayed, this means that the tunnel endpoint is unknown. In this case, the tunnel must be configured by the peer (e.g. teleworker).
<b>Suggested Lifetime of the Session Keys</b>	Displays the accepted validity period for the session keys which will be used. When this period expires, no more data is exchanged within this session. New session keys are automatically negotiated to replace invalid session keys.
<b>Suggested Lifetime of the Key Exchange Session</b>	Displays the accepted validity period for the key exchange session. Once the key exchange session has expired, new keys are automatically negotiated for it using the IKE protocol (encryption protocol).
<b>Associated Rules: Associated Transmit Rule</b>	Setup of Send Rules under VPN > Rules
<b>Associated Rules: Associated Receive Rule</b>	Setup of Receive Rules under VPN > Rules
<b>Tunnel Data</b>	
<b>Name of the Tunnel</b>	This field contains the name of the configured tunnel.
<b>State in IP Stack</b>	Status indicator in the IP stack. Value range: active / not active
<b>Type of the Local Tunnel Endpoint</b>	Displays the endpoint address at the sending end of the tunnel; you can specify a host name or a DNS name).
<b>Local Tunnel Endpoint Address</b>	Displays the endpoint address in the local tunnel.
<b>Type of the Remote Tunnel Endpoint</b>	Displays the endpoint type of the remote tunnel.
<b>Remote Tunnel Endpoint Address</b>	Displays the recipient address of the remote tunnel. If the address of 0.0.0.0 is displayed, this means that the tunnel endpoint is unknown. In this case, the tunnel must be configured by the peer (e.g. teleworker).
<b>Rule Data</b>	
<b>Destination</b>	Status indicator in the Destination. Value range: send/ receive
<b>Priority</b>	Displays the priority for the processing sequence. The highest priority is specified with 1. Each rule associated with a direction must be assigned its own priority. A rule and the associated opposite-direction rule must always have the same priority. The rule for the opposite direction can only be created with the corresponding menu item.
<b>Rule-Based Action</b>	Displays how the IP packets are to be handled by the rule: "pass" means that IP packets are forwarded; "deny" means that no IP packets are forwarded.
<b>Encryption Required</b>	Displays an encryption for this rule. The encryption procedure is defined by the assigned tunnel.
<b>Rule State</b>	Status indicator in the rule. Value range: enabled/ disabled
<b>State in IP Stack</b>	Status indicator in the IP stack. Value range: active / not active

Parameters	Description
<b>Source Address</b>	
Displays the source and destination address in a format suitable for the selected type. The display depends on the selected address type. If any IP address is to be used, 0.0.0.0 is displayed. NAT must be deactivated at the interface to the destination network if 0.0.0.0 is specified as the destination IP address for transmitting packets in a tunnel. Alternatively, you can specify an IP address between 0.0.0.1 and 255.255.255.254 to transmit packets in a tunnel.	
<b>Type</b>	Displays the type of the source address and destination address (possible values are: host, subnet, IP address range and DNS name).
<b>Address (Lowest in Range)</b>	Displays the source and destination address in a format suitable for the selected type. The input mask depends on the address type selected. If any IP address is to be used, 0.0.0.0 is displayed. NAT must be deactivated at the interface to the destination network if 0.0.0.0 is specified as the destination IP address for transmitting packets in a tunnel. Alternatively, you can specify an IP address between 0.0.0.1 and 255.255.255.254 to transmit packets in a tunnel.
<b>Subnet Mask / Highest Addr. in Range</b>	It is set in case that a range of source/destination addresses need to be set for transmission
<b>Destination Address</b>	
<b>Type</b>	Displays the type of the source address and destination address (possible values are: host, subnet, IP address range and DNS name).
<b>Address (Lowest in Range)</b>	Displays the source and destination address in a format suitable for the selected type. The input mask depends on the address type selected. If any IP address is to be used, 0.0.0.0 is displayed. NAT must be deactivated at the interface to the destination network if 0.0.0.0 is specified as the destination IP address for transmitting packets in a tunnel. Alternatively, you can specify an IP address between 0.0.0.1 and 255.255.255.254 to transmit packets in a tunnel.
<b>Subnet Mask / Highest Addr. in Range</b>	It is set in case that a range of source/destination addresses need to be set for transmission
<b>Service Data</b>	
Displays the service to which the encryption is restricted. If the encryption is not to be restricted to one service, select "Any Service"	
<b>Name of the Service</b>	Input field for the name of the service to be configured.
<b>Source Port</b>	Displays the tunnel in the receive direction, to which this rule applies. IP packets received by the network are retrieved from this tunnel. Select No Tunnel Assignment if no tunnel is to be assigned in the receive direction.
<b>Destination Port</b>	Displays the tunnel in the send direction, to which this rule applies. IP packets destined for the network are sent through this tunnel. Select No Tunnel Assignment if no tunnel is to be assigned in the send direction.
<b>IP protocol</b>	IP protocol to be used for the transmission Value range: ICMP, TCP, UDP
<b>Name of the Tunnel</b>	This field contains the name of the newly configured tunnel.
<b>Enable Remote Service via VPN : (can be activated via the service code)</b>	Check this box if the VPN tunnel is to be used for remote administration.
<b>Type of the Local Tunnel Endpoint</b>	Select the endpoint address type at the sending end of the tunnel; you can specify a host name or a DNS name.

Parameters	Description
<b>Local Tunnel Endpoint Address</b>	Enter the sender's address in a format suitable for the endpoint type.
<b>Type of the Remote Tunnel Endpoint</b>	Type of endpoint address on the tunnel receive side (specification of IP address is supported).
<b>Remote Tunnel Endpoint Address</b>	Receive address in a format suitable for the endpoint type. In this field, 0.0.0.0 indicates that the tunnel endpoint is unknown. In this case, the tunnel must be configured by the peer (e.g. teleworker).
<b>Session Key Handling</b>	Under Session Key Handling, specify the procedure for the key exchange (Automatically, using IKE protocol).
<b>Suggested Encryption Algorithms</b>	Which algorithms may be used Value range: AES, 3DES
<b>Suggested Hash Algorithms</b>	Which hash algorithms (testing algorithms) may be used. The selected algorithms are offered by the initiator of IKE negotiation. Value range: MD5, SHA1, SHA2
<b>Suggested Lifetime of the Session Keys</b>	Validity period for the session keys that are used. When this period expires, no more data is exchanged within this session. New session keys are automatically negotiated to replace invalid session keys
<b>Suggested Lifetime of the Key Exchange Session</b>	Validity period for the key exchange session. Once the key exchange session has expired, new keys are automatically negotiated for it using the IKE protocol
<b>Suggested Data Volume of the Session Keys</b>	Maximum data volume for the session keys. If the data volume is exceeded, new session keys are automatically negotiated using the IKE protocol. If "unlimited" is selected, the amount of data is unrestricted
<b>Activate Perfect Forward Secrecy</b>	It is recommended to always select this option, since it activates improved security mechanisms for data transfer via the tunnel
<b>VPN Peer Authentication Method</b>	VPN subscriber authentication method. The possible options include Digital Signatures (authentication using certificates) and Pre-Shared Keys (authentication using self-defined manual keys)
<b>Pre-Shared Key</b>	This field is only available if the authentication method is set to Pre-Shared keys. The password to be used by the VPN subscribers at both endpoints of the tunnel must be entered here. At least 12 characters should be used
<b>Reenter Pre-Shared Key</b>	This field is only available if the authentication method is set to Pre-Shared keys.
<b>List of CA Certificates</b>	These options are only available if the authentication method is set to Digital signatures. For authentication, VPN subscribers can use any certificate that has been issued (signed) by one of the selected CA certificates
<b>Suggested Diffie-Hellman Groups</b>	VPN subscribers can exchange keys by any of the selected methods

---

**INFO:** The addition/deletion of a VPN tunnel must subsequently be enabled under "VPN> Activate the Configured VPN Tables".

---

### 27.3.2.18 Security > VPN > Rules > Active Rules

Parameter Description of the Tab:

- **Display Rules**

Parameters	Description
<b>Priority</b>	Displays the priority for the processing sequence as a digit. The highest priority is specified with 1. Each rule associated with a direction must be assigned its own priority. A rule and the associated opposite-direction rule must always have the same priority.
<b>Service</b>	Displays the service to which the encryption is restricted. If the encryption is not restricted to one service, "Any Service" is displayed.
<b>Rule-Based Action</b>	Displays how the IP packets are to be handled by this rule: "pass" means that IP packets are forwarded; "deny" means that no IP packets are forwarded.
<b>Encryption Required</b>	Displays the encryption. The encryption procedure is defined by the assigned tunnel.
<b>Rule State</b>	Status indicator in rule. Value range: Enabled / Disabled
<b>State in IP Stack</b>	Status indicator in the IP stack. Value range: Enabled / Disabled
<b>Source Address</b>	
<b>Type</b>	Displays the type of the source address. Value range: Host, Subnet, IP Address Range, DNS Name
<b>Address (Lowest in Range)</b>	Displays the source and destination address in a format suitable for the selected type. The input mask depends on the address type selected. If any IP address is to be used, 0.0.0.0 is displayed. NAT must be deactivated at the interface to the destination network if 0.0.0.0 is specified as the destination IP address for transmitting packets in a tunnel. Alternatively, you can specify an IP address between 0.0.0.1 and 255.255.255.254 to transmit packets in a tunnel.
<b>Subnet Mask / Highest Addr. in Range</b>	It is set in case that a range of source/destination addresses need to be set for transmission
<b>Destination Address</b>	
<b>Type</b>	Displays the type of the destination address. Value range: Host, Subnet, IP Address Range, DNS Name
<b>Address (Highest in Range)</b>	
<b>Subnet Mask / Highest Addr. in Range</b>	It is set in case that a range of source/destination addresses need to be set for transmission
<b>Tunnels for Encryption</b>	
<b>Tunnel on Receive Side</b>	Displays the tunnel in the receive direction, to which this rule applies. IP packets received by the network are retrieved from this tunnel. Display: No Tunnel Assignment (if no tunnel was assigned in the receive direction).
<b>Tunnel on Transmit Side</b>	Displays the tunnel in the send direction, to which this rule applies. IP packets received by the network are retrieved from this tunnel. Display: No Tunnel Assignment (if no tunnel was assigned on the transmit side).

### 27.3.2.19 Security > VPN > Rules > Configured Rules

Rules define how IP packets are to be handled. The rule action Pass means that the IP packet is to be transported further (passed through). The rule action Deny means that the IP packet will not be transported further (i.e., will be ignored). You can also select whether or not the IP packet will use an encrypted VPN tunnel. The communication system can manage 640 rules, of which 6 rules are preset (default rules) and 634 are free for allocation.

Parameter Description of Tabs::

- **Display Rules**
- **Add Rule**
- **Edit Rule**
- **Add Rule for Opposite Direction**
- **Delete Rule**

Parameters	Description
<b>Priority</b>	Displays the priority for the processing sequence as a digit. The highest priority is specified with 1. Each rule associated with a direction must be assigned its own priority. A rule and the associated opposite-direction rule must always have the same priority.
<b>Service</b>	Displays the service to which the encryption is restricted. If the encryption is not restricted to one service, "Any Service" is displayed.
<b>Rule-Based Action</b>	Displays how the IP packets are to be handled by this rule: "pass" means that IP packets are forwarded; "deny" means that no IP packets are forwarded.
<b>Encryption Required</b>	Displays the encryption. The encryption procedure is defined by the assigned tunnel.
<b>Rule State</b>	Status indicator in the rule. Value range: enabled/ disabled
<b>State in IP Stack</b>	Status indicator in the IP stack. Value range: Enabled / Disabled
<b>Source Address</b>	
<b>Type</b>	Displays the type of the source address. Value range: Host, Subnet, IP Address Range, DNS Name
<b>Address (Lowest in Range)</b>	Displays the source and destination address in a format suitable for the selected type. The input mask depends on the address type selected. If any IP address is to be used, 0.0.0.0 is displayed. NAT must be deactivated at the interface to the destination network if 0.0.0.0 is specified as the destination IP address for transmitting packets in a tunnel. Alternatively, you can specify an IP address between 0.0.0.1 and 255.255.255.254 to transmit packets in a tunnel.
<b>Subnet Mask / Highest Addr. in Range</b>	It is set in case that a range of source/destination addresses need to be set for transmission
<b>Destination Address</b>	
<b>Type</b>	Displays the type of the destination address. Value range: Host, Subnet, IP Address Range, DNS Name
<b>Address (Highest in Range)</b>	

Parameters	Description
<b>Subnet Mask / Highest Addr. in Range</b>	It is set in case that a range of source/destination addresses need to be set for transmission
<b>Tunnels for Encryption</b>	
<b>Tunnel on Receive Side</b>	Displays the tunnel in the receive direction, to which this rule applies. IP packets received by the network are retrieved from this tunnel. Display: No Tunnel Assignment (if no tunnel was assigned in the receive direction).
<b>Tunnel on Transmit Side</b>	Displays the tunnel in the send direction, to which this rule applies. IP packets received by the network are retrieved from this tunnel. Display: No Tunnel Assignment (if no tunnel was assigned on the transmit side).

### 27.3.2.20 Security > VPN > Public Key Infrastructure (PKI)

The PKI server designates a server that can issue, distribute and verify digital certificates. The certificates issued within a PKI (Public Key Infrastructure) are used to protect communications. When using certificates (digital signatures), an attempt is made to download the CRL via the PKI URL configured by the PKI server.

Parameter Description of Tabs::

- **Display PKI Servers**
- **Add PKI Server**

Parameters	Description
<b>Name of the PKI Server</b>	Enter an easily recognizable name for the server.
<b>PKI Server Type</b>	Select the task of the server (you can choose between LDAP and Enrollment).
<b>URL of the PKI Server</b>	Enter the URL of the server (for example: LDAP://139.21.92.144:389).

### 27.3.2.21 Security > SSL > Certificate Generation

Administrative access is encrypted over HTTPS using the TLS 1.2 protocol. Certificates are used to authenticate the connection. By default, a self-signed certificate is used. A customer-specific certificate issued by a certificate authority (CA) can be used to enhance security. The communication system uses the certificates generated or imported by the WBM for authentication at the admin client. Such certificates can be imported into the browser as trusted certificates to avoid warning messages in the browser when connecting to the SSL server.

Parameter Description of Tabs:

- **Generate CA Certificate**
- **Generate Self-Signed Certificate**



Parameters	Description
<b>Name of the Certificate</b>	Name of the certificate to be generated.
<b>Serial Number of Certificate</b>	Serial number for the certificate. This number must be a positive integer
<b>Type of Signature Algorithm</b>	Signature algorithm to be used Value range: sha256RSA, sha512RSA
<b>Public Key Length</b>	Value range, default value: 2048
<b>Start Time of Validity Period (GMT)</b>	
Point of time as of which the certificate should be valid. The time specified is interpreted as Greenwich Mean Time (GMT).	
<b>Day, Month, Year, Hrs, Mins, Sec.</b>	Time specification units for the certificate validity period
<b>End Time of Validity Period (GMT)</b>	
Point of time until which the certificate should be valid. The time specified is interpreted as Greenwich Mean Time (GMT)	
<b>Day, Month, Year, Hrs, Mins, Sec.</b>	Time specification units for the certificate validity period
<b>Subject Name</b>	
Subject name data of the certificate applicant according to the conventions of the X.509 standard (e.g., DE for Germany in the Country (C) field). All four fields must be filled.	
<b>Country (C)</b>	Two-digit country code
<b>Organization (O)</b>	The full legal company name
<b>Organization Unit (OU)</b>	The Organizational Unit is whichever branch of the company is ordering the certificate
<b>Common Name (CN)</b>	Fully Qualified Domain Name (FQDN)
<b>Alternative Subject Name</b>	
This optional information distinguishes between the Distinguished Name Format (such as the data under Subject Name) and Other Format (for example, the IP address entry). The input mask depends on the selected format. If other format is selected, more than one SAN entries is possible to be configured..	
<b>Distinguished Name Format</b>	This is usually also provided as the Common Name RDN within the Subject field of the main certificate
<b>Other Format</b>	Other names, given as a General Name
<b>Subject Alternative Name Extension</b>	(optional)Value range, default value: DNS Name, IP Address, E-mail Address, Uniform ResourceIndicator, Other
<b>Subject Alternative Name</b>	
<b>CRL Distribution Point Type</b>	Value range: DNS Name, IP Address, E-mail Address, Uniform Resource Indicator, Other
<b>CRL Distribution Point</b>	The location from which certificate revocation lists (CRL) are to be distributed can be optionally specified here (with a URL)

### 27.3.2.22 Security > SSL > Certificate Management

Parameter Description of the Tab:

- **View Certificate From File**

Parameters	Description
<b>PKCS#12 Format</b>	This field must be activated if the certificate is saved in a PKCS#12 file.
<b>Passphrase for decryption</b>	If the PKCS#12 Format field was activated, the same password that was used when creating the file must be entered in this field.
<b>File with Certificate</b>	Enter the path and file name of the certificate. If necessary, click Browse to specify the location.

### 27.3.2.23 Security > SSL > Certificate Management > Server Certificates

Parameter Description of Tabs:

- **Generate Certificate Signing Request (CSR)**
- **Import Server Certificate (PKCS#12)**
- **View a Certificate**
- **Remove Certificate**
- **Export Certificate (X.509)**
- **Import Updated Certificate (X.509)**
- **Activate Certificate**

Parameters	Description
<b>Certificate Request Name</b>	Name of the certificate to be generated.
<b>Type of Signature Algorithm</b>	Signature algorithm to be used for this certificate Value range: sha256RSA, sha512RSA
<b>Public Key Length</b>	Value range: 2048
<b>Subject Name</b>	Subject name data of the certificate applicant according to the conventions of the X.509 standard (e.g., DE for Germany in the Country (C) field). All four fields must be filled.
<b>Country (C)</b>	Two-digit country code
<b>Organization (O)</b>	The full legal company name
<b>Organization Unit (OU)</b>	The Organizational Unit is whichever branch of the company is ordering the certificate
<b>Common Name (CN)</b>	Fully Qualified Domain Name (FQDN)
<b>Alternative Subject Name</b>	This optional information distinguishes between the Distinguished Name Format (such as the data under Subject Name) and Other Format (for example, the IP address entry). The input mask depends on the selected format. If other format is selected, more than one SAN entries is possible to be configured..
<b>Distinguished Name Format</b>	This is usually also provided as the Common Name RDN within the Subject field of the main certificate
<b>Other Format</b>	Other names, given as a General Name

Parameters	Description
<b>Subject Alternative Name Extension</b>	(optional) Value range, default value: DNS Name, IP Address, E-mail Address, Uniform Resource Indicator, Other
<b>Subject Alternative Name</b>	(optional)
<b>Name of the Certificate</b>	Name of the certificate to be imported.
<b>Passphrase for decryption</b>	Password that was used when the file was created. Value range: 7 to 32 characters
<b>File with Certificate</b>	Enter the required certificate in the <b>File with Certificate</b> field or select it using Browse. The <b>Fingerprint</b> of the certificate must displayed first and can then be imported.

### 27.3.2.24 Security > Web Security

Parameter Description of the Tab:

- **Web Access Filter**

Parameters	Description
<b>Web Clients</b>	Only in conjunction with UC Suite: Enabling and disabling web access from mobile phones and mobile applications (myPortal for Mobile/Tablet, myPortal to go, myPortal for OpenStage, Application Launcher and 3rd party applications via a Web Service)  Info: Use of web clients in conjunction with UC Smart via Expert mode > Applications > UC Smart > Basic Settings
<b>Access via HTTPS</b>	Only encrypted connections allowed.
<b>Access via HTTP</b>	Unencrypted connections are allowed.
<b>Save login data for devices</b>	When enabled, login credentials do not need to be entered whenever the application is started

### 27.3.2.25 Security > SQL Security

Parameter Description of the Tab:

- **SQL Access Password**

Parameters	Description
<b>Generate New</b>	An encrypted SQL password, not known to the user, is generated.
<b>Activate default</b>	The default SQL password is activated.

## 27.3.3 Network Interfaces

Functions such as the configuration of the individual interfaces are grouped together under **Network Interfaces**. The interfaces can be configured separately.

### 27.3.3.1 Network Interfaces > Mainboard > Host Name

Parameter Description of Tabs::

- **Editing the Host Name**

Parameters	Description
<b>Host Name</b>	Host name of the communication system - optional. Example: <code>commsystem</code>  If the name and IP address of the communication system are stored on a DNS server, name resolution can occur. The name of the communication system is composed of the host name and the domain name. Example: <code>commsystem.mynet.home</code>

### 27.3.3.2 Network Interfaces > Mainboard > LAN 1 (WAN)

Parameter Description of Tabs:

- **Show LAN 1 Mode**
- **Edit LAN 1 Interface**
- **Edit ACD**

Parameters	Description
<b>Internet Service Provider Selection</b>	Selection to determine how access to an ISP (Internet Service Provider) via the WAN interface occurs.
<b>Internet Service Provider Selection: Not configured or disabled</b>	The WAN interface is not used.
<b>Internet Service Provider Selection: LAN Connection Type TCP/IP</b>	The WAN interface is used for access to an ISP, which is already configured in an external Internet router. The communication system and Internet router do not need to be on the same LAN segment, but the WAN interface must be connected to the LAN segment of the Internet router.
<b>Internet Service Provider Selection: T-Online, T-DSL Business, ...</b>	The communication system functions as an Internet router. The WAN interface is used for access to a preconfigured ISP.
<b>Internet Service Provider Selection: Provider PPPoE</b>	The communication system functions as an Internet router. The WAN interface is used for access to an ISP using PPPoE. PPPoE is the protocol most commonly used by DSL modems.
<b>Internet Service Provider Selection: Provider PPTP</b>	The communication system functions as an Internet router. The WAN interface is used for access to an ISP using PPTP. This variant is common in Austria, for example.
<b>Internet access via an external Router</b>	Access to the Internet occurs via an external router.
<b>Automatic Address Configuration (via DHCP)</b>	An external DHCP server (possibly the DHCP server of the Internet router) assigns an IP address to the communication system.
<b>Accept IP Address of the Default Router</b>	The external DHCP server communicates the IP address of the default router (e.g., the Internet router) to the communication system.

Parameters	Description
<b>Accept IP Address of the DNS Server</b>	The external DHCP server communicates the IP address of the DNS server to the communication system.
<b>Accept IP Address of the SNTP Server</b>	The external DHCP server communicates the IP address of the SNTP server to the communication system.
<b>IP address</b>	IP address of the LAN interface.
<b>Subnet Mask:</b>	Netmask of the LAN segment.
<b>MAC Address</b>	Displays the MAC address of the LAN interface.
<b>Ethernet Link Mode</b>	WAN interface mode.
<b>Ethernet Link Mode: Auto</b>	Automatic switching between 100 and 1000 Mbps and half duplex and full duplex mode.
<b>Ethernet Link Mode: 100HDX</b>	100 Mbps, half duplex.
<b>Ethernet Link Mode: 100FDX</b>	100 Mbps, full duplex.
<b>Ethernet Link Mode: 1000FDX</b>	1000 Mbps, full duplex.
<b>NAT</b>	NAT (Network Address Translation) is turned on. This task is usually already assumed by the external router.
<b>Bandwidth Control for Voice Connections</b>	This field enables bandwidth control for voice connections.
<b>Bandwidth for Downloads</b>	Value of the full download bandwidth in Kbps provided by the ISP.
<b>Bandwidth for Uploads</b>	Value of the full upload bandwidth in Kbps provided by the ISP.
<b>Bandwidth Used for Voice/Fax (%)</b>	Percentage of bandwidth available for voice/fax connections. Value range, default value: 0 - 100, 80
<b>IEEE802.1p/q Tagging</b>	If this check box is selected, a "type of service" is included in the Ethernet packets (Layer 2) for prioritization purposes. The option is deactivated by default.
<b>IEEE802.1p/q VLAN ID</b>	Enter the VLAN's ID number if the used switch has problems with the default value "0".
<b>Layer 2 QoS Class</b>	
<b>Signaling Data</b>	Priority class for the connection setup. 0 = lowest priority / 7 = highest priority. Value range, default value: 0 - 7, 3
<b>Fax/Modem Payload</b>	Priority class for the fax and modem data of the IP connection. 0 = lowest priority / 7 = highest priority. Value range, default value: 0 - 7, 5
<b>Network Control</b>	Priority class for the network control data (transfer of SNMP traps, for example). 0 = lowest priority / 7 = highest priority. Value range, default value: 0 - 7, 0
<b>Voice Payload</b>	Priority class for the voice data of the IP connection. 0 = lowest priority / 7 = highest priority. Value range, default value: 0 - 7, 5
<b>Internet Access Data for ...</b>	

Parameters	Description
<b>Connection ID / User Name / T-Online number / Subuser Number/Suffix / Internet Access Account / DSL-Login ...</b>	Access data of the Internet Service Provider.
<b>CHAP Password</b>	Password for access to the Internet Service Provider.
<b>Reenter Password</b>	Password for access to the Internet Service Provider.
<b>IP parameters</b>	
<b>Remote IP Address of the PPP Connection</b>	IP address of the ISP server, if the ISP uses a static IP address.
<b>Local IP Address of the PPP Connection</b>	IP address that was assigned by your ISP for Internet access.
<b>IP Address Negotiation</b>	Selection to determine how the connection partners should negotiate the IP address at connection setup.
<b>IP Address Negotiation: configured IP address</b>	Only the configured IP address is possible.
<b>IP Address Negotiation: accept any IP address</b>	Any address proposed by the partner is accepted.
<b>IP Address Negotiation: request new IP address</b>	A new IP address is requested at each connection.
<b>DNS Request</b>	
<b>Internet Access with DNS Request</b>	The DNS server is determined automatically.
<b>IP Address of primary DNS Server</b>	A special DNS server is selected.
<b>General PPP Parameters</b>	
<b>Default Router</b>	The PPP connection created here is used as the routing destination.
<b>IP Header Compression</b>	The TCP header is compressed. UDP and RTP headers are always compressed.
<b>Send LCP Echo Request</b>	An LCP echo request is sent. This function is used to check if the connection is still active.
<b>Automatic PPP Reconnection</b>	The PPP connection is automatically reestablished after a connection clear-down (for example, in the case of ISP access with a flat rate and a forced disconnect after 24 hours).
<b>PPTP Parameter</b>	
<b>Local IP Address of the Control Connection</b>	IP address that was assigned by your ISP for the PPTP connection.
<b>Remote IP Address of the Control Connection</b>	IP address of your ISP's server for the PPTP connection.
<b>Remote subnet mask for the control connection</b>	Subnet mask that was assigned by your ISP for the PPTP connection.
<b>Short Hold</b>	
<b>Short Hold</b>	The "short hold" operating mode is turned on for the PPP connection. The following entry is only possible when short-hold mode is enabled.

Parameters	Description
<b>Short Hold Time (sec)</b>	Length of time without data transmissions after which the PPP connection should be cleared. The short hold timer is only triggered by outgoing packets.  Value range, default value: 10 - 9999, 60
<b>Authentication</b>	
<b>PPP Authentication</b>	PPP authentication is enabled. The setting must be made in accordance with the specifications of the ISP.
<b>PPP User Name</b>	Freely selectable user name to be used for authentication via PAP or CHAP.
<b>PAP Authentication Mode</b>	Activation and type of PAP authentication for the PPP connection: Not used, PAP Client, PAP Host.
<b>PAP Password</b>	Password for PAP authentication.
<b>CHAP Authentication Mode</b>	Activation and type of CHAP authentication for the PPP connection: Not used, CHAP Client, CHAP Host, CHAP Client and Host.
<b>CHAP Password</b>	Password for CHAP authentication.
<b>Data Compression</b>	
<b>DEFLATE Data Compression</b>	For the compression of PPP data packets with the compression algorithm DEFLATE.
<b>COMPRESS Data Compression</b>	For the compression of PPP data packets with the compression algorithm COMPRESS.
<b>Address Translation</b>	
<b>NAT</b>	NAT (Network Address Translation) is turned on. The following protocols are supported: TCP, UDP and ICMP (only in passive mode).
<b>Address Mapping</b>	will be dropped according to Mr. Naendorf
<b>Router Settings</b>	
<b>Full-Time Circuit</b>	Depending on the tariff model, the full-time circuit (permanent connection) to the ISP can be enabled or disabled. The full-time circuit should be disabled for a time-based tariff model and enabled for a flat rate tariff model.
<b>Short Hold Time (sec)</b>	If Full-Time Circuit is disabled (time-based tariff model), enter the duration of inactivity after which the connection is to be dropped (e.g., 60 seconds).  Value range, default value: 10 - 9999, 60
<b>Forced Disconnect at (hour:min)</b>	If Full-Time Circuit is enabled (flat-rate tariff model), enter the time at which the Internet connection is to be deactivated (e.g., 04:59).
<b>Connection Time</b>	Displays the elapsed connection time in days-hours-minutes-seconds.
<b>QoS Parameters of Interface</b>	
<b>Bandwidth for Downloads</b>	Value of the full download bandwidth in Kbps provided by the ISP.
<b>Bandwidth for Uploads</b>	Value of the full upload bandwidth in Kbps provided by the ISP.
<b>Bandwidth Control for Voice Connections</b>	Bandwidth control prevents the transmission rates available from being overbooked with voice connections within a multi-link connection. In other words, when header compression is active, a maximum of 5 voice connections are permitted over a B channel. This field enables bandwidth control for voice connections. Only voice connections with routes configured in the voice gateway are considered here.
<b>Bandwidth Used for Voice/Fax (%)</b>	Percentage of bandwidth available for voice/fax connections.  Value range, default value: 0 - 100, 80

Parameter Description of Tabs:

- **Edit ACD**

Parameters	Description
<b>Connection Time</b>	Displays the elapsed connection time in days-hours-minutes-seconds.
<b>Force Reconnect at</b>	Time at which the connection is to be cleared and reestablished.
<b>Enable ACD</b>	Enable automatic clear-down to pre-empt disconnection by the ISP at an inopportune time.

### 27.3.3.3 Network Interfaces > Mainboard > LAN 2

Parameter Description of Tabs::

- **Edit LAN 2 Interface**

Parameters	Description
<b>Internet access via an external Router</b>	Access to the Internet occurs via an external router.
<b>Interface Is Active</b>	The LAN interface is enabled.
<b>IP address</b>	IP address of the communication system.
<b>Subnet Mask:</b>	Subnet mask of the LAN segment in which the communication system is located.
<b>MAC Address</b>	Displays the MAC address of the communication system.
<b>Ethernet Link Mode</b>	LAN interface mode.
<b>Ethernet Link Mode: Auto</b>	Automatic switching between 100 and 1000 Mbps and half duplex and full duplex mode. In this mode, you can enable the power management.  After migration to V2R3 or later Apply on top must be pressed for the desired ethernet link through the network interface page in order the value to be set to Auto.  Otherwise, the systems must be set to Auto or 100 before migration.
<b>Ethernet Link Mode: 100HDX</b>	100 Mbps, half duplex. Power management cannot be enabled in this mode.
<b>Ethernet Link Mode: 100FDX</b>	100 Mbps, full duplex. Power management cannot be enabled in this mode.
<b>Ethernet Link Mode: 1000FDX</b>	1000 Mbps, full duplex. Power management cannot be enabled in this mode.
<b>IEEE802.1p/q Tagging</b>	If this check box is selected, a "type of service" is included in the Ethernet packets (Layer 2) for prioritization purposes. The option is deactivated by default.
<b>IEEE802.1p/q VLAN ID</b>	Enter the VLAN's ID number only if the used switch has problems with the default value "0".
<b>Layer 2 QoS Class</b>	
<b>Signaling Data</b>	Priority class for the connection setup. 0 = lowest priority / 7 = highest priority.  Value range, default value: 0 - 7, 3



Parameters	Description
<b>Fax/Modem Payload</b>	Priority class for the fax and modem data of the IP connection. 0 = lowest priority / 7 = highest priority. Value range, default value: 0 - 7, 5
<b>Network Control</b>	Priority class for the network control data (transfer of SNMP traps, for example). 0 = lowest priority / 7 = highest priority. Value range, default value: 0 - 7, 0
<b>Voice Payload</b>	Priority class for the voice data. 0 = lowest priority / 7 = highest priority. Value range, default value: 0 - 7, 5

### 27.3.3.4 Network Interfaces > Mainboard > LAN 3 (Admin)

Parameter Description of Tabs::

- **Edit LAN 3 Interface**

Parameters	Description
<b>Interface Is Active</b>	The LAN interface is enabled.
<b>Automatic Address Configuration (via DHCP)</b>	An external DHCP server assigns an IP address to the communication system.
<b>Accept IP Address of the Default Router</b>	The external DHCP server communicates the IP address of the default router (e.g., the Internet router) to the communication system.
<b>Accept IP Address of the DNS Server</b>	The external DHCP server communicates the IP address of the DNS server to the communication system.
<b>Accept IP Address of the SNTP Server</b>	The external DHCP server communicates the IP address of the SNTP server to the communication system.
<b>IP address</b>	IP address of the LAN interface.
<b>Subnet Mask:</b>	Netmask of the LAN segment.
<b>MAC Address</b>	Displays the MAC address of the LAN interface.
<b>Ethernet Link Mode</b>	LAN interface mode.
<b>Ethernet Link Mode: Auto</b>	Automatic switching between 100 and 1000 Mbps and half duplex and full duplex mode.
<b>Ethernet Link Mode: 100HDX</b>	100 Mbps, half duplex.
<b>Ethernet Link Mode: 100FDX</b>	100 Mbps, full duplex.
<b>Ethernet Link Mode: 1000FDX</b>	1000 Mbps, full duplex.

### 27.3.3.5 Network Interfaces > Mainboard > FTP Server

Parameter Description of Tabs::

- **Edit FTP Server Parameters**

Parameters	Description
<b>Enable FTP Server</b>	If this check box is selected, the internal FTP server is released.
<b>Download User 'Phone'</b>	
<b>Name</b>	Name for the access of IP phones to the FTP server to download the latest software updates. The name cannot be changed.
<b>New password</b>	Password for the access of IP phones to the FTP server. If the predefined password is changed, the password must also be changed at the IP phones.
<b>Confirm Password</b>	Password for the access of IP phones to the FTP server.
<b>Download User 'ftpadmin'</b>	
<b>Name</b>	Name of administrator access to the FTP server. The name cannot be changed.
<b>New password</b>	Password for administrator access to the FTP server.
<b>Confirm Password</b>	Password for administrator access to the FTP server.

### 27.3.3.6 Network Interfaces > Mainboard > DHCP Mode

Parameter Description of Tabs::

- **Edit DHCP Mode**

Parameters	Description
<b>No DHCP</b>	Enabling this radio button disables the internal DHCP server.
<b>DHCP Server</b>	Enabling this radio button enables the internal DHCP server.
<b>DHCP Relay Agent</b>	Enabling this radio button causes the communication system to act as a DHCP relay agent. The DHCP requests of the IP stations are forwarded from the communication system to the actual DHCP server. The DHCP server and the IP stations do not have to be in the same network segment.

### 27.3.3.7 Network Interfaces > Mainboard > DHCP Mode > DHCP Server > Global Parameters

The network-specific data is transmitted from the DHCP server to the IP stations.

Parameter Description of Tabs::

- **Edit Global Parameters**

Parameters	Description
<b>Enable DHCP Server</b>	Indicates that the internal DHCP server is enabled and that its global parameters can be configured. Cannot be changed.
<b>Subnet Mask:</b>	The subnet mask defines the size of the subnet. Example: 255.255.255.0.
<b>Broadcast Address</b>	With the broadcast address, all IP stations of a network or subnet can be addressed by the DHCP server (optional). Example: 0.0.0.0.

Parameters	Description
<b>Default Gateway</b>	
<b>Gateway 1</b>	IP address under which the default gateway can be reached.  If an Internet router is used in the network, the Internet router is the default gateway. Example: 192.168.1.1.  If the communication system is directly connected to an Internet modem, the communication system is the default gateway. Example: 192.168.1.2.
<b>Gateway 2</b>	IP address under which a second default gateway (router) can be reached (optional).
<b>Gateway 3</b>	IP address under which a third default gateway (router) can be reached (optional).
<b>DNS Server</b>	
<b>Domain Name</b>	Domain name of the internal network, max. 80 characters, e.g., mynet.home (optional).
<b>Server 1</b>	IP address under which the DNS server can be reached.  If the communication system is directly connected to an Internet modem, the default value 0.0.0.0 must not be changed. The communication system uses it to automatically connect to a DNS server from the Internet.  An external DNS server can also be entered. Example: the DNS server of the Internet router (192.168.1.1) or a DNS server from the Internet (google-public-dns-a.google.com).
<b>Server 2</b>	IP address under which a second DNS server can be reached (optional).
<b>Server 3</b>	IP address under which a third DNS server can be reached (optional).
<b>Lease time in hours (0 infinite)</b>	Maximum validity period in hours, 0 = infinite lifetime (default: 1 hour).
<b>Enable Dynamic DNS Update</b>	If this check box is enabled, the DNS server may be dynamically updated. Default: not enabled.  <b>IMPORTANT:</b> If Dynamic DNS Update option is enabled, it is mandatory to configure <b>Domain Name</b> in IP Address Pool respective Domain name field.
<b>Use Internal DLI</b>	If this check box is selected, the internal DLI is used. If is check box is cleared, the parameters for an external DLS server appear. Default: enabled.
<b>External DLS Server</b>	
<b>IP address</b>	IP address under which the external DLS server can be reached.
<b>Port</b>	Port through which the external DLS server can be reached.

### 27.3.3.8 Network Interfaces > Mainboard > DHCP Mode > DHCP Server > IP Address Pools

Parameter Description of Tabs::

- **Display IP Address Pools**
- **Add IP Address Pool**
- **Edit IP Address Pool**
- **Delete IP Address Pool**

Parameters	Description
<b>Subnet address</b>	The subnet address defines the maximum IP address range. Example: 192.168.1.0.
<b>Subnet Mask:</b>	The subnet mask defines the size of the subnet. Default setting: 255.255.255.0.
<b>address range</b>	
<b>Address range 1</b>	Lower and upper limits of the IP address range of the subnet. Example: from 192.168.1.50 to 192.168.1.254.
<b>Address range 2</b>	Lower and upper limits of a second IP address range within the same subnet (optional).
<b>Address range 3</b>	Lower and upper limits of a third IP address range within the same subnet (optional).
<b>Default Gateway</b>	
<b>Gateway 1</b>	IP address under which the default gateway can be reached.  If an Internet router is used in the network, the Internet router is the default gateway. Example: 192.168.1.1.  If the communication system is directly connected to an Internet modem, the communication system is the default gateway. Example: 192.168.1.2.
<b>Gateway 2</b>	IP address under which a second default gateway (router) can be reached (optional).
<b>Gateway 3</b>	IP address under which a third default gateway (router) can be reached (optional).
<b>Broadcast Address</b>	With the broadcast address, all IP stations of a network or subnet can be addressed by the DHCP server (optional). Default: 0.0.0.0.
<b>Domain Name</b>	Domain name of the internal network, max. 80 characters, e.g., mynet.home (optional).
<b>DNS Server</b>	
<b>Server 1</b>	IP address under which the DNS server can be reached.  If the communication system is directly connected to an Internet modem, the default value 0.0.0.0 must not be changed. The communication system uses it to automatically connect to a DNS server from the Internet.  An external DNS server can also be entered. Example: the DNS server of the Internet router (192.168.1.1) or a DNS server from the Internet (google-public-dns-a.google.com).
<b>Server 2</b>	IP address under which a second DNS server can be reached (optional).
<b>Server 3</b>	IP address under which a third DNS server can be reached (optional).
<b>Lease time in hours (0 infinite)</b>	Maximum validity period in hours, 0 = infinite lifetime (default: 1 hour).

### 27.3.3.9 Network Interfaces > Mainboard > DHCP Mode > DHCP Server > Static IP Addresses

Parameter Description of Tabs::

- **Display Static IP Address**
- **Add Static IP Address**
- **Edit Static IP Address**
- **Delete Static IP Address**

Parameters	Description
<b>Hostname</b>	Name or description of the IP station (e.g., PC or server) that is to receive a fixed IP address. Example: <code>Print Server</code> .
<b>IP address</b>	Desired fixed IP address. Example: <code>192.168.1.10</code> .
<b>Client Identifier</b>	MAC address of the IP station.
<b>Subnet Mask:</b>	Netmask of the subnet. Example: <code>255.255.255.0</code> .
<b>Default Gateway</b>	
<b>Gateway 1</b>	IP address under which the default gateway can be reached.  If an Internet router is used in the network, the Internet router is the default gateway. Example: <code>192.168.1.1</code> .  If the communication system is directly connected to an Internet modem, the communication system is the default gateway. Example: <code>192.168.1.2</code> .
<b>Default Gateway 1</b>	IP address under which a second default gateway (router) can be reached (optional).
<b>Default Gateway 1</b>	IP address under which a third default gateway (router) can be reached (optional).
<b>Broadcast Address</b>	With the broadcast address, all IP stations of a network or subnet can be addressed by the DHCP server (optional). Example: <code>0.0.0.0</code> .
<b>Domain Name</b>	Domain name of the internal network, max. 80 characters, e.g., <code>mynet.home</code> (optional).
<b>DNS Server</b>	
<b>Server 1</b>	IP address under which the DNS server can be reached.  If the communication system is directly connected to an Internet modem, the default value <code>0.0.0.0</code> must not be changed. The communication system uses it to automatically connect to a DNS server from the Internet.  An external DNS server can also be entered. Example: the DNS server of the Internet router ( <code>192.168.1.1</code> ) or a DNS server from the Internet ( <code>google-public-dns-a.google.com</code> ).
<b>Server 2</b>	IP address under which a second DNS server can be reached (optional).
<b>Server 3</b>	IP address under which a third DNS server can be reached (optional).
<b>Lease time in hours (0 infinite)</b>	Maximum validity period in hours, 0 = infinite lifetime (default: 1 hour).

### 27.3.3.10 Network Interfaces > Mainboard > DHCP Mode > DHCP Server > Last active Leases

The IP address assigned by a DHCP server remains valid for an IP station until the "lease period" expires, even if the IP station is turned off during that time. The last active assignments are displayed here.

Parameter Description of Tabs::

- **Display Lease**
- **Delete Lease**

Parameters	Description
<b>IP address</b>	IP address assigned to the IP station by the DHCP server.
<b>MAC Address</b>	MAC address of the IP station to which an IP address was assigned.
<b>Client ID</b>	Client ID of the IP station. If the client ID is not available, the MAC address of the IP station is displayed.
<b>Hostname</b>	Name or call number of the IP station to which an IP address was assigned.
<b>Start of lease</b>	Start time of the assignment. The IP station is assigned an IP address as of this point in time.
<b>End of lease</b>	Ending time of the assignment. After this period, the IP station needs to send a new request for an IP address.

### 27.3.3.11 Network Interfaces > Mainboard > DHCP Mode > DHCP Server > All Leases

The IP address assigned by a DHCP server remains valid for an IP station until the "lease period" expires, even if the IP station is turned off during that time. All assignments are displayed here.

Parameter Description of Tabs::

- **Display Lease**
- **Delete Lease**

Parameters	Description
<b>IP address</b>	IP address assigned to the IP station by the DHCP server.
<b>MAC Address</b>	MAC address of the IP station to which an IP address was assigned.
<b>Client ID</b>	Client ID of the IP station. If the client ID is not available, the MAC address of the IP station is displayed.
<b>Hostname</b>	Name or call number of the IP station to which an IP address was assigned.
<b>Start of lease</b>	Start time of the assignment. The IP station is assigned an IP address as of this point in time.
<b>End of lease</b>	Ending time of the assignment. After this period, the IP station needs to send a new request for an IP address.

### 27.3.3.12 Network Interfaces > Application Board > Host Name

Parameter Description of Tabs::

- **Editing the Host Name**

Parameters	Description
<b>Host Name</b>	Host name of the Application Board - freely selectable. Example: <code>applboard</code>  If the name and IP address of the Application Board are stored on a DNS server, name resolution can occur. The name of the Application Board is composed of the host name and the domain name. Example: <code>applboard.mynet.home</code>

### 27.3.3.13 Network Interfaces > Application Board > LAN 1

Parameter Description of Tabs::

- **Edit Lan 1 Interface**

Parameters	Description
<b>Interface Is Active</b>	If this check box is selected, the LAN 1 interface of the Application Board is active.
<b>Automatic Address Configuration (via DHCP)</b>	If this check box is selected, the IP address and subnet mask are automatically assigned by the DHCP server for the LAN 1 interface. In addition, it is also possible to select whether further network-specific parameters are to be transferred from the DHCP server.
<b>Accept IP Address of the Default Router</b>	If this check box is selected, the IP address of the default router is taken over by the DHCP server.
<b>Accept IP Address of the DNS Server</b>	If this check box is selected, the IP address of the DNS server is taken over by the DHCP server.
<b>Accept IP Address of the SNTP Server</b>	If this check box is selected, the IP address of the SNTP server is taken over by the DHCP server.
<b>IP address</b>	IP address under which the Application Board can be reached.
<b>Subnet Mask:</b>	Subnet mask under which the Application Board can be reached.
<b>MAC Address</b>	MAC address of the Application Board (not editable).
<b>Ethernet Link Mode</b>	Mode of the LAN 1 interface.
<b>Ethernet Link Mode: Auto</b>	Automatic switching between 100 and 1000 Mbps and half duplex and full duplex mode. In this mode, you can enable the power management.
<b>Ethernet Link Mode: 100HDX</b>	100 Mbps, half duplex. Power management cannot be enabled in this mode.
<b>Ethernet Link Mode: 100FDX</b>	100 Mbps, full duplex. Power management cannot be enabled in this mode.
<b>Ethernet Link Mode: 1000FDX</b>	1000 Mbps, full duplex. Power management cannot be enabled in this mode.

### 27.3.3.14 Network Interfaces > Application Board > LAN 2

Parameter Description of Tabs:

- **Edit Lan 2 Interface**

Parameters	Description
<b>Interface Is Active</b>	If this check box is selected, the LAN 2 interface of the Application Board is active.
<b>IP address</b>	IP address under which the Application Board can be reached.
<b>Subnet Mask:</b>	Subnet mask under which the Application Board can be reached.
<b>MAC Address</b>	MAC address of the Application Board (not editable).
<b>Max. Data Packet Size (Bytes)</b>	Maximum packet length in bytes applicable for the IP protocol. Values between 576 and 1500 are permitted.
<b>Ethernet Link Mode</b>	Mode of the LAN 2 interface.
<b>Ethernet Link Mode: Auto</b>	Automatic switching between 100 and 1000 Mbps and half duplex and full duplex mode. In this mode, you can enable the power management.
<b>Ethernet Link Mode: 100HDX</b>	100 Mbps, half duplex. Power management cannot be enabled in this mode.
<b>Ethernet Link Mode: 100FDX</b>	100 Mbps, full duplex. Power management cannot be enabled in this mode.
<b>Ethernet Link Mode: 1000FDX</b>	1000 Mbps, full duplex. Power management cannot be enabled in this mode.
<b>IEEE802.1p/q Tagging</b>	If this check box is selected, the Ethernet format used by the Application Board is set. The option is deactivated by default.
<b>IEEE802.1p/q VLAN ID</b>	Enter a value that differs from the default value "0" as the VLAN's ID number if the switch used has problems with the default value "0".
<b>Layer 2 QoS Class</b>	
<b>Signaling data</b>	Priority class for the connection setup. 0 = lowest priority / 7 = highest priority.
<b>Fax/Modem Payload</b>	Priority class for the fax and modem data of the IP connection. 0 = lowest priority / 7 = highest priority.
<b>Network Control</b>	Priority class for the network control data (transfer of SNMP traps, for example). 0 = lowest priority / 7 = highest priority.
<b>Voice Payload</b>	Priority class for the voice data of the IP connection. 0 = lowest priority / 7 = highest priority.

## 27.3.4 Routing

Routing tables are managed under **Routing**. In small networks, a routing table can be set up manually on every router by the administrator. In larger networks, this task is automated with the help of a protocol that distributes routing information in the network.

### 27.3.4.1 Routing > IP Routing > Mainboard > Static Routes

The communication system supports static routes only. Static routes connect two IP devices with each other. They are created manually.



Depending on the application, it may be necessary to set a different routes for the system (mainboard) and the UC Booster Card (Application Board).

Parameter Description of Tabs::

- **Display Static Route Table**
- **Add Static Route**
- **Edit Static Route**
- **Delete Static Route**

Parameters	Description
<b>Route Index:</b>	The route index is automatically assigned and only displayed for information purposes. It cannot be modified.
<b>Route Name:</b>	Name or description of the static route; freely selectable.
<b>Destination Network/Host:</b>	IP address of the destination network.
<b>Subnet Mask:</b>	Subnet mask of the destination network.
<b>Route Gateway:</b>	IP address of the next router on this route or IP address of the local or remote interface of a PSTN peer.

#### 27.3.4.2 Routing > IP Routing > Mainboard > Default Router

Depending on the application, it may be necessary to set a different default routing for the system (mainboard) and the UC Booster Card (Application Board).

Parameter Description of Tabs::

- **Edit Default Router**

Parameters	Description
<b>Default Routing via</b>	Enable or disable IP routing via a default router.
<b>No interface</b>	Disable IP routing via a default router.
<b>LAN</b>	Enable IP routing via a default router.
<b>IP Address of Default Router</b>	IP address of the default router, provided <b>LAN</b> is selected as the interface in the <b>Default Routing via</b> field. Example: IP address of the Internet router, 192.168.1.1.

#### 27.3.4.3 Routing > IP Routing > Mainboard > DNS Server

You can display, and where applicable, edit the IP address of the DNS server. The setting is necessary for trunking with dynamic IP addresses.

Parameter Description of Tabs::

- **Edit DNS Settings**

Parameters	Description
<b>IP Address of DNS Server</b>	<p>IP address under which the DNS server can be reached.</p> <p>If the communication system is directly connected to an Internet modem, the default value 0.0.0.0 must not be changed. The communication system uses it to automatically connect to a DNS server from the Internet.</p> <p>An external DNS server can also be entered. Example: the DNS server of the Internet router (192.168.1.1) or a DNS server from the Internet (google-public-dns-a.google.com).</p> <p>In case of an OpenScape Business S system, a system reboot is necessary in order the changes to be applicable.</p>

#### 27.3.4.4 Routing > IP Routing > Application Board > Static Routes

Depending on the application, it may be necessary to set a different routes for the system (mainboard) and the UC Booster Card (Application Board).

Parameter Description of Tabs:

- **Display Static Route Table**
- **Add Static Route**
- **Edit Static Route**
- **Delete Static Route**

Parameters	Description
<b>Route Index:</b>	The route index is automatically assigned and only displayed for information purposes. It cannot be modified.
<b>Route Name:</b>	Name or description of the static route; freely selectable (optional) Value range: max. 35 characters
<b>Destination Network/Host:</b>	IP address of the destination network.
<b>Subnet Mask:</b>	Subnet mask of the destination network.
<b>Route Gateway:</b>	IP address of the next router on this route or IP address of the local or remote interface of a PSTN peer.

#### 27.3.4.5 Routing > IP Routing > Application Board > Default Router

Depending on the application, it may be necessary to set a different default routing for the system (mainboard) and the UC Booster Card (Application Board).

Parameter Description of Tabs::

- **Change Default Router**

Parameters	Description
<b>Default Routing via</b>	Enable or disable IP routing via a default router.
<b>No interface</b>	Disable IP routing via a default router.
<b>LAN</b>	Enable IP routing via a default router.
<b>IP Address of Default Router</b>	IP address of the default router, provided LAN is selected as the interface in the "Default Routing via" field.

### 27.3.4.6 Routing > NAT

NAT rules for network address translation can be displayed, added, edited and deleted. The NAT Table Editor allows you to edit all existing and new NAT entries at once for network address translation.

Parameter Description of Tabs::

- **Add NAT**
- **NAT Table Editor**

Parameters	Description
<b>NAT Rule Active</b>	
<b>Description</b>	
<b>Local IP Address</b>	Local destination address on the LAN.
<b>Local port</b>	Enter the port number of the active LAN protocol.
<b>Global Port</b>	Port number of the active protocol.
<b>Protocol</b>	Transport protocol to be used. The set transport protocol applies both for local and global addresses.
<b>Protocol: TCP</b>	TCP (Transmission Control Protocol)  TCP is a reliable, connection-oriented protocol for the transmission of IP packets. Before transfer starts, a virtual channel is set up between the two terminal points. Data can be transmitted in both directions on this channel. TCP is mainly used in the WorldWideWeb and in e-mail and peer-to-peer networks. It is also used for call signaling in IP telephony because it can detect and automatically rectify data losses during transmission.
<b>Protocol: UDP</b>	UDP (User Datagram Protocol)  UDP is a reliable, connectionless protocol for the transmission of IP packets. In contrast to TCP/peer scenarios, a virtual channel is not set up before transfer starts so that the PCs can start transferring data without delay. In UDP, the port number of the service that should receive the data is included when addressing voice packets. It is mainly used in the DNS sector and for voice transmission in IP telephony. However, since a connectionless protocol does not check if the peer actually received the data, this option can result in voice transfer losses.

### 27.3.4.7 Routing > PSTN

These parameters are used to set up an IP remote connection (dial-up) via the traditional telephone network.

Parameter Description of Tabs::

- **Edit Global PSTN Data**

Parameters	Description
<b>Router Call Number(Internal Call Number)</b>	Used to select the DID number of the system. All applications that use the router function can be reached from an external location via this DID number. External routing partners that do not transfer a station number must each use different call numbers. These station numbers are configured as MSNs.
<b>Redialing</b>	
<b>Number of Redial Attempts</b>	Number of redial attempts that should be made by the system to set up a connection Value range: 0 to 255
<b>Pause between Redial Attempts (sec)</b>	Interval between redial attempts in seconds. Value range: 1 - 1,000
<b>Scripting</b>	
<b>Identification of User 1 for Scripting</b>	First part of account credentials to log in at Internet providers. The Internet provider requires host, user identification and password entries, for example, Host=ERT005, User=KJUMBERT, Password=123456. The entries are therefore as follows: Identification of User 1 for Scripting: HOST:ERT005 - Identification of User 2 for Scripting: USER:KJUMBERT - New Password for Scripting: PASSWORD:123456.
<b>Identification of User 2 for Scripting</b>	Second part of account credentials to log in at Internet providers.
<b>New Password for Scripting</b>	Password to log in at Internet Providers.

### 27.3.4.8 Routing > PSTN > PPP Log

Parameter Description of Tabs:

- **Load via HTTP**

Parameters	Description
<b>Load</b>	The PPP log file can be loaded via HTTP. Depending on your browser settings, you will be prompted to select whether the downloaded log file should be saved or opened in the default editor.

### 27.3.4.9 Routing > PSTN > PSTN Partner

Parameter Description of Tabs::

- **Add PSTN Peer**

- **Display PSTN Peer**
- **Edit PSTN Peer**

Parameters	Description
<b>Peer Name</b>	PSTN Peer Name. The following PSTN peers are available: <ul style="list-style-type: none"> <li>• Default PSTN - not configurable</li> <li>• PSTN Peer 1: default for CLA, reconfigurable function</li> <li>• PSTN Peer 2: default for ISDN, reconfigurable function</li> <li>• PSTN Peer 3: name and function freely configurable</li> <li>• PSTN Peer 4: name and function freely configurable</li> </ul> Value range: 1 to 14 characters
<b>PSTN Connection Type</b>	Setup of the PSTN Connection: (Default selection: Enabled).
<b>PSTN Connection Type: Not configured</b>	PSTN peers can be preconfigured. However, this setting prevents a connection being set up over this PSTN peer.
<b>PSTN Connection Type: Active</b>	PSTN peer is enabled. This setting allows a connection to be set up via this PSTN peer.
<b>PSTN Connection Type: DSL Fallback</b>	Use of the DSL access for the PSTN connection (the default router is the DSL access)
<b>IP parameters</b>	
<b>IP Address of PSTN Peer</b>	IP address of the host PC on the peer side, to which the PSTN connection is established.
<b>IP Address of Local PSTN Interface</b>	IP address of the local communication system, which is used for the PSTN connection.
<b>IP Address Negotiation</b>	Negotiation of the IP address between the connection partners when setting up the connection.
<b>IP Address Negotiation: configured IP address</b>	Only the configured IP address of the PSTN peer is accepted.
<b>IP Address Negotiation: accept any IP address</b>	No IP address negotiation
<b>IP Address Negotiation: request new IP address</b>	The IP address is negotiated
<b>General PPP Parameters</b>	
<b>Default Router</b>	The PSTN peer set up here should not only be preconfigured, but also used as a routing destination. There can only be one default router. This is either the DSL access or the PSTN peer set up here.
<b>Internet Access with DNS Request</b>	The access is to be used for Internet access. Only one Internet access per system may be activated (either a PSTN partner or a DSL connection).
<b>Service Entry</b>	The Call no. test function should be disabled when calling the MSN of the PSTN peer. The Service Entry function can only be activated if the PSTN peer has an MSN number and a PAP or CHAP authentication has been activated.
<b>MSN/DID Number(Internal Call Number)</b>	Configuration of the MSN number. A station number transferred by the partner must be configured, as otherwise the call is rejected. If, on the other hand, the partner has configured call numbers but does not transfer any, a connection will be set up anyway.

Parameters	Description
<b>B channels</b>	Number of used B channels. Value range: 1 or 2
<b>Callback</b>	A call is rejected, and the peer is then called back immediately. This prevents unauthorized peers from dialing in. The calling station must use the ISDN connection's D channel to transfer the station number and must permit dial-in via the system. This station number must be configured for the outgoing direction at the PSTN peer. If callback is enabled, only outgoing connections from this peer are accepted. A connection cannot be set up if the peer is also a gateway and if callback is also enabled for this connection, since neither of the peers accepts an incoming connection setup. In the case of such a faulty configuration where only "callback without redial" is enabled, this can be detected, and a continuous connection setup can be suppressed. However, the problem is not detected if redial is enabled.
<b>V.34 Peer</b>	Accept a V.34 Peer (e.g., a modem).
<b>Automatic PPP Reconnection</b>	The PPP connection is automatically reestablished after a connection cleardown (for example, in the case of ISP access with flat rate and a forced disconnect after 24 hours).
<b>Send LCP Echo Request</b>	An LCP echo request is sent. This function is used to check if the connection is still active.
<b>Short Hold</b>	
<b>Short Hold</b>	The "short hold" operating mode is turned on for the PPP connection. The following entries are only possible when short-hold mode is active.
<b>Short Hold Time (sec)</b>	Length of time without data transmissions after which the PPP connection should be cleared. The Short Hold Timer is only triggered by outgoing packets. Value range: 10 to 9999
<b>Short Hold Charge Pulse Analysis</b>	Optimization of the short-hold mode, taking the charge pulse into account. Charge pulse analysis is performed for calls over PPP (evaluation of facility messages with AoC info elements). If the Internet service provider does not supply call charge information, then the default timeout value is set to 0 seconds.
<b>Authentication</b>	
<b>PPP Authentication</b>	PPP authentication is enabled.
<b>PPP User Name</b>	Freely selectable user name to be used for authentication via PAP or CHAP.
<b>PAP Authentication Mode</b>	Activation and type of PAP authentication for the PPP connection: Not used, PAP Client, PAP Host.
<b>PAP Password</b>	Password for PAP authentication.
<b>CHAP Authentication Mode</b>	Activation and type of CHAP authentication for the PPP connection: Not used, CHAP Client, CHAP Host, CHAP Client and Host.
<b>CHAP Password</b>	Password for CHAP authentication.
<b>Header Compression</b>	
<b>IP Header Compression</b>	The compression of the IP/TCP or IP/UDP/RTP header is enabled. Header compression improves data transmission in Voice-over-PPP scenarios. All voice packets with UPD port numbers in the set range are compressed.
<b>Data Compression</b>	
<b>DEFLATE Data Compression</b>	Compression using the DEFLATE algorithm

Parameters	Description
<b>COMPRESS Data Compression</b>	Compression with the COMPRESS algorithm
<b>Address Translation</b>	
<b>NAT</b>	NAT (Network Address Translation) is turned on. The following protocols are supported: TCP, UDP and ICMP (only in passive mode).
<b>Address Mapping</b>	Address mapping is enabled.
<b>QoS Parameters of Interface</b>	
<b>Bandwidth Control for Voice Connections</b>	Bandwidth control prevents the transmission rates available from being overbooked with voice connections within a multi-link connection. In other words, when header compression is active, a maximum of 5 voice connections (G.729 / 60 msec or G.723/60 msec) are permitted over a B channel. This field enables bandwidth control for voice connections. Only voice connections with routes configured in the voice gateway are considered here.
<b>Bandwidth Used for Voice/Fax (%)</b>	Percentage of bandwidth available for voice/fax connections. Value range, default value: 0 - 95, 80

Parameter Description of Tabs::

- **Reset to Factory Default**

Parameters	Description
<b>Apply</b>	The values for the selected PSTN partners are reset to the factory default values.

Parameter Description of Tabs::

- **Add Call Number**
- **Change station number**
- **Delete Call Number**

Parameters	Description
<b>Call number</b>	The call number at which the PSTN peer can be reached. It must be unique within the entire configuration and can comprise up to 22 decimal digits (0 to 9). Hyphens are permitted. Up to five call numbers can be configured for each PSTN peer. A station number is checked as it is being transferred, and calls are only accepted if a PSTN peer is assigned appropriate call authorization for the incoming station number.
<b>Call direc.</b>	The connection occurs under the phone number entered above.
<b>Call direc.: Blocked</b>	The number cannot be used.
<b>Call direc. : incoming</b>	The peer may make calls but may not be called.
<b>Call Direction: outgoing</b>	The peer may be called but may not make calls.
<b>Call direc. : Incoming and Outgoing</b>	The peer may be called and can also make calls.
<b>Delete</b>	The dialed station number will be deleted.

## 27.3.5 LCR

The Least Cost Routing features such as classes of service, dial plans, routing tables, and dial rules are grouped under **LCR**.

### 27.3.5.1 LCR > LCR flags

Parameter Description of the Tab:

- **Edit LCR Flags**

Parameters	Description
<b>LCR Flags</b>	
<b>Activate LCR</b>	LCR is activated and thus enables least cost routing.
<b>Reset LCR data</b>	
<b>Delete the configured LCR data and initialize the LCR with default data</b>	If this radio button is selected, the configured LCR entries (dial plans, routing tables, dial rules) are deleted and replaced by the default entries.

---

**INFO:** An invalid configuration in the LCR could potentially prevent or restrict outgoing connections.

---

### 27.3.5.2 LCR > Classes Of Service

Parameter Description of the Tab:

- **Edit LCR Classes of Service**

Parameters	Description
<b>Index</b>	Hierarchical index list
<b>Phone number</b>	Station number
<b>Name</b>	Name of the station
<b>Access groups</b>	Every subscriber is assigned to an LCR class of service (COS) group. By default, all subscribers are entered with the maximum LCR Class of Service (15) Value range: 1 to 15

---

**INFO:** A subscriber can only seize a route if his or her COS is greater than or equal to the LCR COS in the routing table.

---



### 27.3.5.3 LCR > Dial Plan

Parameter Description of Tabs::

- **Change Dial Plan**
- **Display Dial Plan**

Parameters	Description
<b>Dial Plan</b>	The dial plan is searched for patterns that match the dialed digits. The result is used as a criterion for selecting the route table. At the same time, the system checks if the subscriber's class of service matches for this route. For external connections, each call number including the code (up to a maximum of 24 characters incl. field separators) is checked in the dial plan. The dial plan then determines a route table for the station; the station is assigned this table for the connection setup. Up to 16 routes are created via a single route table. The Dialing rules table defines how the digits selected by the station are converted and dialed by the communication system.
<b>Name</b>	The Name column can be used to assign a name to each profile, e.g., local call, long-distance call, international, etc. Depending on the version of the communication system, the Name column may or may not be displayed. A meaningful name should be selected when assigning names. Multiple instances of the same name may be used. Appropriate names are automatically assigned via the Dial Rule wizard.
<b>Dialed digits</b>	Using this scheme, the call number is evaluated in order to branch to the appropriate route table. The field delimiters C and - as well as the placeholders X, N and Z can be used. Fixed digits 0...9 - Field delimiters (evaluation through the dial rule); X - placeholder for a digit from 0...9; N - placeholder for a digit from 2..9; Z - placeholder for one or more digits until end of dialing; C - simulated dial tone (can be entered a maximum of 3 times)
<b>Route table</b>	The Route table column is used to specify which route table is to be used for the profile. The arrow links to the definition of the respective route table.  Value range: 1 to 254, of which 1 to 15 preset
<b>Acc. code</b>	The checkbox for this column is selected/cleared to determine whether or not an account code entry is mandatory after the seizure code (in the U.S.: after end-of-dialing). When the checkbox is cleared, the account code is not required until the dial plan has been dialed completely if it has been configured for the route.
<b>Toll restriction</b>	When selected, the dialed digits are subject to toll restriction (class of service). This applies to networking, as well as to standalone communication systems. With this, individual call numbers can be removed from the toll restriction. If the toll restriction should be applied, the known rules for Allowed/Denied Lists apply.
<b>Emergency</b>	If a number that was configured as an emergency number (emergency column checkbox selected) is dialed, and no free line is available, then a line that is being used for a non-emergency number (emergency column checkbox cleared) is disconnected and then made available automatically for the emergency number.

### 27.3.5.4 LCR > Routing Table

Parameter Description of Tabs:

- **Change Routing Table**

Parameters	Description
<b>Route tables</b>	Call numbers defined in the dial plan are assigned an action (choice) here via the route tables.  Value range: 254 route tables
<b>Index</b>	The route table is searched from top to bottom in hierarchical order. The system checks to determine whether the route is free and the station has the requisite LCR class of service. If this is the case, dialing occurs in accordance the outdial rule and schedule entered in the route table.  Value range: 1 to 16
<b>Dedicated Route</b>	The fixed route that was assigned to the subscriber (e.g., via the route assignment of the multisite management) is used.
<b>Route</b>	For details on the route to be assigned, see "Trunks/Routing > Routes"  Default value: Route name configured in the system
<b>Dial Rule</b>	LCR outdial rules can be used to convert the phone numbers entered into random new digit strings for additional processing. Access to different carriers is enabled via digit translation. Definition under "Dial Rule".  Value range: 254 dial rules
<b>min. COS</b>	COS describes the minimum LCR class-of-service needed by a station in order to use the associated route. It is thus possible to stipulate, for example, that one station is only permitted to place calls via a specific carrier or during certain times, while other stations have the option of using alternative routes. The value for the maximum class of service is 15.  Value range: 1 to 15
<b>Warning</b>	If the first route selection in the route table is busy, the LCR function advances to the next (possibly more expensive) route configured in the route group table. The system can notify the user of this with an audible signal, an optical signal, or both.  Value range: None, Tone, Display, Display + Tone
<b>Dedicated Gateway</b>	This parameter defines the way in which the destination partner node is identified in an IP internetwork.  Value range: No, Forced, Multi-location
<b>Dedicated Gateway: No</b>	The partner node is identified by the destination call number.
<b>Dedicated Gateway: Forced</b>	Routed is forced via the gateway that is defined by its node ID in the <b>GW Node ID</b> column.
<b>Dedicated Gateway: Multi-location</b>	Caller-based determination of the partner node: Routing occurs via the gateway that was assigned to the respective caller via the Multigateway wizard or in the <b>Stations &gt; Edit workpoint client data &gt; Secondary system ID</b> input mask. For callers without a related entry, routing occurs via the gateway that is defined by its node ID in the <b>GW node ID</b> column (default).
<b>GW Node ID</b>	Specifies the gateway node ID for the <b>Forced</b> or <b>Multi-location</b> options of the <b>Dedicated Gateway</b> parameter.
<b>Buttons</b>	
Blue arrow in the <b>Dial Rule</b> column	Displays the page with the <b>Dial Rule</b> parameters.

### 27.3.5.5 LCR > Dial Rule

Parameter Description of the Tab:

- **Edit Outdial Rule**

Parameters	Description
	LCR outdial rules can be used to convert the phone numbers entered into random new digit strings for additional processing. Access to different carriers is enabled via digit translation. The dial rule used is defined by the route table entry.
<b>Rule Name</b>	Freely definable name of the dial rule; some dial rules are predefined Value range: max. 16 characters
<b>Dial rule format</b>	Program for the digits to be dialed. The individual program steps are processed from left to right. The characters for the program code represent the following functions:
<b>A</b>	Repeat remaining fields (transmit). The letter "A" causes all subsequent digit fields to be retransmitted. The point of reference is the last field delimiter in the field of dialed digits in the dial plan. If "A" is entered without an explicit reference, it designates all digits after the access code, i.e., "A" is then equivalent to "E2A"
<b>B</b>	It is used for the multi-gateway network when a station number of type TON (Type Of Number) that was called from outside is "unknown" and must be routed to the multi-gateway node. To ensure that this station number is unique, it is extended to national or international in accordance with the TON in the LCR. This is required when the DID numbers are not unique and need to be configured in the national or international format.
<b>D (n)</b>	Dial digit sequence (1 to 25 digits). "D" may occur multiple times and at any position in the string.
<b>E (n)</b>	Transmit field contents (1 to 10). "E" may occur multiple times and at any position in the string. "E" can also appear in any order with relation to (n). A specific field can be addressed multiple times, including in sequence. With the exception of "E1" (access code), this letter may be surrounded by any other parameters. With digit-by-digit dialing (as opposed to en-bloc dialing), the last element in the outdial rule must not be E(n), but E(n)A.
<b>M (n)</b>	Authorization code (1 to 16). This letter must not be in the final position.
<b>P (n)</b>	P (n) can occur more than once in the string and can be placed in any position. P (n) can be surrounded by any other parameters.(1 to 60 times the system-wide pause unit).
<b>S</b>	Switch, changes signaling methods from DP to DTMF (with CONNECT, PROGRESS or CALL PROC with PI). The letter "S" may occur in the string only once and must not be in the final position. The "C" parameter cannot be used after "S".
<b>C</b>	Carrier "C" can be inserted in the string only once. The subsequent characters are transmitted without a dial pause and are used for single stage, two-stage, DICS (not for U.S.), BRI, and PRI carrier access.
<b>U</b>	Use subaddress signaling method. The letter "U" may occur in the string only once and must not be in the final position. The "S", "P", "M", and "C" parameters cannot be used after "U".
<b>N (n) (only for the U.S.!)</b>	Network SFG (1 to 5) or Band Number (1).
<b>L (for U.S. only!):</b>	"L" must only occur at the end of a string of characters. "L" causes the call to be handled as an emergency call.

Parameters	Description
<b>Network provider's method of access</b>	Selection of the respective network provider
<b>Unknown</b>	No explicit specification about a network carrier.
<b>Main network supplier</b>	When seizing a trunk using the main network supplier, simplified dialing into the public network is performed by en-bloc dialing or by dialing individual digits.
<b>MCL Single Stage</b>	With MCL Single Stage, a prefix is used to dial the desired network carrier, and the station number is then dialed. Dialing occurs in the D channel for ISDN or as normal dialing for MSI.
<b>MCL Two-Stage</b>	With MCL Two Stage, a prefix is used to dial the desired network carrier. After a synchronization phase, a configurable authorization code is initially sent, followed by the destination call number as DTMF digits. With synchronization during timeout, you must program a pause of 2 to 12 seconds.
<b>Corporate Network</b>	A corporate network is directly connected to OpenScape Business. The LCR function determines the appropriate trunk group based on the station number dialed and then routes the call either via the trunk group in the public exchange or via the trunk group in the corporate network.
<b>Dial-In Control Server</b>	With this type of LCR, the desired network carrier is dialed with a prefix via a dial-in control server, and the call number and configurable authorization code are transmitted in the subaddress. Dialing occurs in the D channel.
<b>Primary Rate Interface (PRI) (U.S. only)</b>	In the case of the Primary Rate Interface, the selection of the network carrier or of a calling service is encoded in SETUP message using following information elements: Network Specific Facility, Operator System Access and Transit Network Selection.
<b>Type</b>	Type Of Number [TON];fFor each dial rule, the following types of number from "Called Party Number" can be selected from the drop-down list: PABX number, local area code, country code. "Unknown" is the default entry. The type of number is only set in E.164. In a network, parameters are set to "Unknown".

### 27.3.5.6 LCR > Multisite

Parameter Description of the Tab:

- **Change area**

Parameters	Description
<b>Area Code</b>	Enter the area code for a site (incl. a leading zero, e.g., 069 for Frankfurt and 030 for Berlin). Different area codes or even the same area code may be entered.
<b>Area</b>	Entry of the name for a site (e.g., the cities matching the area codes, i.e., Frankfurt and Berlin, for example, or department designations such as Service and Sales if the area code is the same).
<b>Dedicated Route</b>	Selection of the route or ITSP registration for this site.
<b>Delete</b>	Deletes the selected site entries.
<b>Buttons</b>	
<b>Save</b>	Saves the changes.

Parameter Description of the Tab:

- **Edit stations/groups**

Parameters	Description
<b>Area</b>	Selection of the site for the station or group.
<b>Dedicated Route</b>	Selection of the route or ITSP registration for the station or group.
<b>Search</b>	Search for stations and groups by entering the search term in the search fields <b>Call no</b> , <b>DID</b> or <b>Name</b> and then pressing the Return key. All stations and groups are listed if all search fields are left empty, and the Return key is pressed.  The <b>Type</b> option can be used to display all station types (e.g., <b>SIP Clients</b> or <b>System Clients</b> ).

## 27.3.6 Voice Gateway

The functions for IP telephony are grouped together under **Voice Gateway**.

### 27.3.6.1 Voice Gateway > SIP Parameters

Parameter Description of Tabs::

- **Edit SIP Parameters**

Parameters	Description
<b>SIP Transport Protocol</b>	
<b>SIP via TCP</b>	Abbreviation for "Transmission Control Protocol". Alongside IP, this is the most important Internet protocol. It provides a connection-based, reliable, full-duplex service in the form of a data channel. It is used, among other things, for networking.
<b>SIP via UDP</b>	Abbreviation for "User Datagram Protocol". This protocol can be used as an alternative to TCP if reliability is not important. UDP does not guarantee packet delivery nor does it ensure that packets are received in a specific sequence. It is used, among other things, for client protocols via ITSP.
<b>SIP via TLS</b>	Abbreviation for "Transport Layer Security". It is used for encrypted data transmission.
<b>SIP registrar</b>	
<b>Period of registration (sec)</b>	Interval (in seconds) at which the registration is repeated. The value of the interval must not be set too high because on repeating the registration, a dropped connection can also be detected, and an alternate route (via ISDN or an alternate Provider) may be selected if required.  Value range, default value: 10 - 86400, 120
<b>RFC 3261 Timer Values</b>	
<b>Transaction Timeout (msec)</b>	Specifies the wait time, in milliseconds, before a retransmission of the invite response for timer D for the RFC 3261 specification. This setting is relevant for the invite client transaction.  Value range, default value: 2000 - 64000, 32000
<b>SIP Session Timer</b>	

Parameters	Description
<b>RFC 4028 support</b>	RFC 4028 defines an expansion of the Session Initiation Protocol (SIP). This expansion allows a periodic refresh of SIP sessions. The user agents and the proxies can use the refresh to determine, whether the SIP session is still active.
<b>Session Expires (sec)</b>	Defines the longest duration of an SIP session. The recommended value is "1800". If possible the figure should not be below this value Value range, default value: 90 - 65535, 1800
<b>Minimal SE (sec)</b>	Defines the shortest duration of an SIP session that is allowed. Value range, default value: 90 - 65535, 90
<b>Provider Calls</b>	
<b>Maximum possible Provider Calls</b>	Number of simultaneous calls via all activated providers. The maximum number depends on the data rate to the Internet and the codec used. Scenario: A number of trunks, e.g., 2, has been created for each activated provider. This would mean a total of 8 trunks for 4 activated providers. If however the bandwidth is only available for 4 calls, then these parameters prevent a 5th call being set up and thereby a disruption to the payload.

### 27.3.6.2 Voice Gateway > ITSP Loc-ID Settings

Parameter Description of Tabs:

- Add ITSP Location Info  
The ITSP location Info is used in the SIP protocol to inform the receiver of an emergency call about the geographical origin of the call. In the SIP protocol the format of location-ID info is defined RFC4119 & RFC5139 (XML coded Location object in the MIME body). The ITSP Loc-ID allows for defining all fields defined in the relevant RFCs whereas in your specific deployment only a subset of these data needs to be configured. (e.g. in Switzerland only the NAM field is used to define a location). The data required to define a location are provided by your ITSP.

Parameters	Description
<b>Loc-ID Name</b>	The name of the Location ID.
<b>Country</b>	The country is identified by the two-letter ISO 3166 code.
<b>A1</b>	National subdivisions (state, region, province, prefecture)
<b>A2</b>	County, parish, gun, district
<b>A3</b>	City, township, shi
<b>A4</b>	City division, borough, city district, ward, chou
<b>A5</b>	Neighborhood, block
<b>A6</b>	Street
<b>PRD</b>	Leading street direction
<b>POD</b>	Trailing street suffix
<b>STS</b>	Street suffix

Parameters	Description
<b>HNO</b>	House number, numeric part only
<b>HNS</b>	House number suffix
<b>LMK</b>	Landmark or vanity address
<b>LOC</b>	Additional location information
<b>FLR</b>	Floor
<b>NAM</b>	Name (residence, business or office occupant).
<b>PC</b>	Postal code
<b>ROOM</b>	Room
<b>PLC</b>	Place - type
<b>PCN</b>	Postal community name
<b>POBOX</b>	Post office box
<b>ADDCODE</b>	Additional Code
<b>SEAT</b>	Seat (desk, cubicle, workstation)
<b>RD</b>	Primary road or street
<b>RDSEC</b>	Road section
<b>RDBR</b>	Road branch
<b>RDSUBBR</b>	Road sub-branch
<b>PRM</b>	Road pre-modifier
<b>POM</b>	Road post-modifier
<b>Activate Advanced Settings</b>	When activated the advanced parameter fields can be configured.
<b>BLD</b>	Building (structure)
<b>UNIT</b>	Unit (apartment, suite)

### 27.3.6.3 Voice Gateway > Codec Parameters

Parameter Description of Tabs:

- **Edit Codec Parameters**

Parameters	Description
<b>Codec</b>	The parameters for the G.711 A-law, G.711 $\mu$ -law, G.729A and G.729AB codecs can be edited.
<b>Codec: G.711 A-law</b>	G.711 (A-law and $\mu$ -law): voice encoding at 56 or 64 Kbps - very high voice quality. G.711 is also used in fixed networks (ISDN). The A-law method is a digitization technique that is used primarily in Europe for analog audio signals in the telecommunications sector.
<b>Codec: G.711 <math>\mu</math>-law</b>	G.711 (A-law and $\mu$ -law): voice encoding at 56 or 64 Kbps - very high voice quality. G.711 is also used in fixed networks (ISDN). In North America and Japan, the $\mu$ -law method, which is similar to the A-law, but not compatible, is used. In order to communicate, e.g., during a telephone conversation between Europe and the United States, the digital data must be translated through appropriate converters.
<b>Codec: G.729A</b>	Voice encoding at 8 Kbps.
<b>Codec: G.729AB</b>	Voice encoding at 8 Kbps. Speech pauses filled in with comfort noise.
<b>Priority</b>	The audio codecs can be assigned priorities between 1 (high) and 4 (low). The communication automatically tries to use the audio codec with the highest priority available for every connection. Using an audio codec with low voice compression (good voice quality) increases network load. In the case of intensive IP telephony, this can lead to diminished voice quality in a network already overloaded by data transfers.
<b>Voice Activity Detection</b>	Enable Voice Activity Detection (VAD). This can reduce network load during long voice pauses.
<b>Frame Size</b>	You can specify a frame size (IP packet size) of 10 to 90 msec for every codec. This specifies the sampling rate at which the audio codec splits the voice signal into IP packets. While a higher value (90 msec, for instance) results in a better relationship between payload and the IP packet overhead, it also increases the transfer delay. The adjustable values depend on the codecs. For networking of OpenScape Business with OpenScape Voice via SIP-Q V2: Cordless IP and OpenScape Mobile Connect only support a frame size of 20 ms for the G.711 codec. If one of these two products is present in the internetwork, the frame size must be to 20 ms here.  Value range, default value: 10 - max. 90, 20
<b>Enhanced DSP Channels</b>	
<b>Use G.711 only</b>	Only the G.711 A-law and G.711 $\mu$ -law protocols are used. With G.711, fewer DSP resources are required, so more simultaneous calls are possible.
<b>T.38 Fax</b>	
<b>T.38 Fax</b>	Defines whether or not the T.38 Fax protocol is to be used.
<b>Use FillBitRemoval</b>	Defines whether or not fill bits should be deleted on sending and restored on receiving when using the T.38 Fax protocol. This makes it possible to save bandwidth.
<b>Max. UDP Datagram Size for T.38 Fax (bytes)</b>	Shows the maximum size of a T.38 UDP datagram in bytes.  Value range, default value: 1 - 1472, 1472
<b>Error Correction Used for T.38 Fax (UDP)</b>	Defines which method is to be used for error correction.  Value range, default value: t38UDPFEC, t38UDPRedundancy
<b>General</b>	
<b>ClearChannel</b>	A ClearChannel is an open channel in which the endpoints are responsible for the protocol in the channel. The parameter defines whether or not the ClearChannel interface functionality is to be enabled.



Parameters	Description
<b>Frame Size</b>	You can set the sampling rate in this field. Possible settings are 10, 20, 30, 40, 50, and 60 milliseconds (msec).  Value range, default value: 10 - 60, 20
<b>RFC2833</b> RFC2833 defines how the tone signals are transmitted.	
<b>Transmission of Fax/Modem Tones according to RFC2833</b>	Outband transmission (via SIP signaling); recommended operating mode to transmit tones securely
<b>Transmission of DTMF Tones according to RFC2833</b>	Outband transmission (via SIP signaling); recommended operating mode to transmit tones securely
<b>Payload Type for RFC2833</b>	Adaptation may be required, depending on the communication partner  Value range, default value: 96 - 126, 98
<b>Redundant Transmission of RFC2833 Tones according to RFC2198</b>	Serves to increase the transmission reliability

#### 27.3.6.4 Voice Gateway > Destination Codec Parameters

Priorities for the use of audio codecs can be defined for specific communication partners.

Parameter Description of Tabs::

- **Add Destination Codec Parameters**

Parameters	Description
<b>Codec: G.711 A-law</b>	G.711 (A-law and $\mu$ -law): voice encoding at 56 or 64 Kbps - very high voice quality. G.711 is also used in fixed networks (ISDN). The A-law method is a digitization technique that is used primarily in Europe for analog audio signals in the telecommunications sector.
<b>Codec: G.711 <math>\mu</math>-law</b>	G.711 (A-law and $\mu$ -law): voice encoding at 56 or 64 Kbps - very high voice quality. G.711 is also used in fixed networks (ISDN). In North America and Japan, the $\mu$ -law method, which is similar to the A-law, but not compatible, is used. In order to communicate, e.g., during a telephone conversation between Europe and the United States, the digital data must be translated through appropriate converters.
<b>Codec: G.729A</b>	Voice encoding at 8 Kbps.
<b>Codec: G.729AB</b>	Voice encoding at 8 Kbps. Speech pauses filled in with comfort noise.
<b>Priority</b>	The audio codecs can be assigned priorities between 1 (high) and 4 (low). The communication automatically tries to use the audio codec with the highest priority available for every connection. Using an audio codec with low voice compression (good voice quality) increases network load. In the case of intensive IP telephony, this can lead to diminished voice quality in a network already overloaded by data transfers.

Parameters	Description
<b>Destination</b>	
<b>Destination Address Type</b>	Displays the type of destination to which the set priorities of the audio codecs are to be assigned.
<b>IP address</b>	IP address of the destination to which the set priorities of the audio codecs apply (e.g., networked node, SIP server)

### 27.3.6.5 Voice Gateway > Internet Telephony Service Provider

Parameter Description of Tabs:

- **Add Internet Telephony Service Provider**
- **Edit Internet Telephony Service Provider**
- **Delete Internet Telephony Service Provider**

Parameters	Description
<b>Base Template</b>	Selection of an empty template (default) or a predefined sample configuration for a particular service provider. This can be adapted to meet individual requirements and saved as a new ITSP.
<b>Provider Name</b>	Desired name of the ITSP. The configured ITSP will appear in the list of ITSPs under this name.
<b>Activate Provider</b>	The ITSP is activated.
<b>Provider Identifier in System</b>	Assignment of a unique designation in the system. A maximum of 8 ITSPs may be active simultaneously. Value range: Providers 1-8
<b>Gateway Domain Name</b>	Gateway Domain Name of the ITSP Often not identical with the web domain name.
<b>Transport protocol</b>	Desired transport protocol. udp or tcp can be selected.
<b>Transport security</b>	The possible values are <b>traditional (udp or tcp)</b> for traditional call using udp/tcp or <b>secure (tls)</b> for secure call using TLS. Default value: traditional (udp or tcp)
<b>Media security</b>	The possible values are <b>RTP only</b> (only AVP profile is supported) or <b>SDES only</b> (only SAVP profile is supported). Default value: RTP only
<b>Provider Registrar</b>	
<b>Use Provider Registrar</b>	Must be selected if the ITSP works with registration.
<b>IP Address / Host name</b>	Domain name or IP address of the Registrar server (e.g., sip-voice.de).
<b>Port</b>	Port number of the Registrar server, e.g., 5060. Enter port 00 if the ITSP uses multiple servers and DNSSRV.

Parameters	Description
<b>Reregistration Interval at Provider (sec)</b>	Interval (in seconds) at which ITSP registration is repeated. The value of the interval must not be 0 and must not be set too high because on repeating the registration at the ITSP, a dropped connection can also be detected, and an alternate route (via ISDN or an alternate Provider) may be selected if required.  Default value: 120 seconds
<b>Provider Proxy</b>	
<b>IP Address / Host name</b>	Domain name or IP address of the proxy server (e.g., sip-voice.de). The entry is mandatory and is usually identical to the provider registrar entry.
<b>Port</b>	Port number of the proxy server (e.g., 5060). As a rule, this is identical with the Provider port number. Enter port 0 if the ITSP uses multiple servers and DNSSRV.
<b>Provider Outbound Proxy</b>	
<b>Use Provider Outbound Proxy</b>	Only set if the ITSP uses an outbound proxy that is different from the provider proxy.
<b>IP Address / Host name</b>	Domain name or IP address of the outbound proxy.
<b>Port</b>	Port number of the outbound proxy. Enter port 0 if the ITSP uses multiple servers and DNSSRV.
<b>Provider Inbound Proxy</b>	
<b>Use Provider Inbound Proxy</b>	Only set if the ITSP optionally sends requests from a second server.
<b>IP Address / Host name</b>	Domain name or IP address of the second ITSP server
<b>Port</b>	Port number of the second ITSP server. Enter port 0 if the ITSP uses multiple servers and DNSSRV.
<b>Provider STUN</b>	
<b>Use STUN</b>	Only set if the ITSP uses a STUN server. The system-wide setting under the STUN configuration applies as the STUN mode for all ITSPs.
<b>IP Address / Host name</b>	STUN IP address if the ITSP is using a STUN server.
<b>Port</b>	STUN port number if the ITSP is using a STUN server.
<b>Extended SIP Provider Data</b>	
<b>Show Extended SIP Provider Data</b>	An adaptation of this data is usually only necessary within the scope of tests with new ITSPs. Details are described in the VoIP Provider Data Collection Document at <a href="http://wiki.unify.com">wiki.unify.com</a> .
<b>Buttons</b>	
<b>Restart ITSP</b>	Initiates a new registration with the ITSP (only possible with an activated ITSP).

Parameter Description of Tabs:

- **Edit STUN Configuration**

Parameters	Description
<b>STUN Mode</b>	This setting applies globally to all ITSPs, provided STUN is enabled for them. Whether STUN is needed or not depends on the ITSP infrastructure and the Internet router used. STUN is not required if the ITSP resolves NAT traversal on its own network. STUN ensures that the publicly accessible IP address is used in SIP messages instead of the internal IP address.
<b>STUN Mode: Always</b>	STUN is always active.
<b>STUN Mode: Automatic</b>	The NAT type of the router to the Internet is checked automatically. If STUN is required, it is enabled. If no STUN is required or possible, STUN is disabled. This is the recommended default setting.
<b>STUN Mode: Use static IP</b>	If the ITSP requires static IP authentication, a static IP address (public IP address) is required in the DSL modem or Internet router. The static IP address and port must be specified in addition.
<b>STUN Mode: Use static IP, Public IP Address</b>	Static IP address of the DSL modem or the Internet router.
<b>STUN Mode: Use static IP, Public SIP Port</b>	Port of the DSL modem or the Internet router.
<b>STUN Mode: Port Preserving router</b>	If none of the STUN modes mentioned above work, this mode should be tried. Some modems and Internet routers do not change the RTP port for NAT and need this mode for proper operation.
<b>Detected Nat-Type</b>	If an ITSP is active, the NAT type will be shown here.
<b>Default STUN Server</b>	
<b>IP address / Host name</b>	IP address or host name of the STUN server (e.g., <code>stun.serviceprovider.com</code> ). This STUN server is used for SIP@Home when no ITSP is being used or if the used ITSP does not offer any STUN server.
<b>Port</b>	Port of the STUN server (e.g., <code>3478</code> )

Parameter Description of Tabs:

- **NAT Type Detection**

Parameters	Description
<b>Automatic activation</b>	Enables automatic detection of the NAT type.
<b>Start NAT type detection</b>	Starts the NAT type detection manually.

Parameter Description of Tabs:

- **Add Internet Telephony Station**
- **Edit Internet Telephony Station**
- **Delete Internet Telephony Station**

Parameters	Description
<b>Internet Telephony Station</b>	Access data of the account assigned by the ITSP. Depending on the ITSP, different designations are used for this, for example: SIP User, SIP ID, etc. You may also need to enter the ITSP customer number here. If static IP authentication is used, the PABX number must be entered here.
<b>Authorization name</b>	Authorization name assigned by the ITSP. This is often identical to the Internet telephony subscriber.
<b>Password</b>	Password assigned by the ITSP. Depending on the ITSP, different designations are used for this, for example: Password, SIP Password, etc.
<b>Confirm Password</b>	Password assigned by the ITSP. Depending on the ITSP, different designations are used for this, for example: Password, SIP Password, etc.

Parameter Description of Tabs:

- **Add MSN Entry**
- **Edit MSN Entry**
- **Delete MSN Entry**
- **Delete All MSN Entries**

Parameters	Description
<b>Internet Telephony Phone Number / Internet Telephony Phone Number / Internet Telephony Phone Number</b>	(Single) Call number assigned by the ITSP.
<b>DID / Internal call number</b>	Assigned internal call number.
<b>Default Entry</b>	Activation as a default entry allows users who do not have their own Internet telephony phone number to make calls via this number. The option can be selected only for an MSN. (only for voice call support, not fax)
<b>Internet Telephony Station / Internet telephony station</b>	Displays the Internet telephony station

Parameter Description of Tabs:

- **Add DID Range**
- **Edit DID Range**
- **Delete DID Range**

Parameters	Description
<b>PABX number</b>	Head number assigned by the ITSP (without the DID number)
<b>Direct inward dialing band from ... to</b>	Range of DID numbers assigned by the ITSP
<b>Begin of internal Call Number range</b>	First internal number as of which an automatic assignment of call numbers is desired.
<b>Assign direct inward dialing band automatically to stations</b>	If selected, the DID numbers are assigned automatically in ascending order to the internal call numbers, and the corresponding MSN entries are generated.

### 27.3.6.6 Voice Gateway > Networking > Nodes

Parameter Description of Tabs::

- **Add Networking Node**
- **Edit Networking Node**
- **Delete Networking Node**

Parameters	Description
<b>Node ID</b>	Only for manual configuration without a wizard, e.g., for open numbering: entry of a node number that is unique in the network.
<b>IP address</b>	Only for manual configuration without a wizard, e.g., for open numbering: IP address of the node
<b>Node Monitoring</b>	The selection of node monitoring causes a periodic review of the communication with the node. As a prerequisite, node monitoring must also be enabled in the other node.
<b>Security Level of Node Encryption</b>	Encryption for voice communication with the node is enabled by selecting "secure". To do this, "Signaling and Payload Encryption" must be additionally configured in the system. Value range: traditional, secure

### 27.3.6.7 Voice Gateway > Networking > Routing

Parameter Description of Tabs::

- **Add Call Number**
- **Delete all station numbers**

Parameters	Description
<b>Node ID</b>	Selects the node number
<b>Phone number</b>	Only for manual configuration without a wizard, e.g., for open numbering: entry of the code via which the node is reachable.

### 27.3.6.8 Voice Gateway > SIPQ-Interconnection

SIP-Q Interconnection is used to define the parameters for two possible external SIP-Q routes. Any external SIP server such as OpenScape 4000 or OpenScape Voice can be connected via these routes. Relevant examples are included in the existing templates.

Parameter Description of Tabs:

- **Add SIPQ-Interconnection**
- **Edit SIPQ-Interconnection**
- **Delete SIPQ-Interconnection**

Parameters	Description
<b>Base Template</b>	Template to be used as a base.
<b>Name</b>	Name of the external SIP server (template name).
<b>Enable Trunk</b>	The connection to the external SIP server is activated. Default value: disabled
<b>Trunk Identifier in System</b>	Selection between two external SIPQ-Interconnections. If present, one of the two SIPQ-Interconnections is always occupied by the UC Booster Card or UC Booster Server.
<b>Remote Domain Name</b>	Host name or IP address of the external SIP server. The value is typically identical to the value at <b>IP Address / Host name</b> .
<b>SIP Server</b>	
<b>IP Address / Host name</b>	Host name or IP address of the external SIP server.
<b>Port</b>	SIP port of the external SIP server. Value range: 0 or 1024 to 65535, default value: 5060
<b>Secure Transport</b>	When connected to OpenScape 4000 or OpenScape Voice, encrypted SIP signaling can be activated (Signaling and Payload Encryption feature). Default value: disabled
<b>SIP Registrar</b>	
<b>Use Provider Registrar</b>	The external SIP server requires registration. Default value: disabled
<b>IP Address / Host name</b>	Host name or IP address of the Registrar server.
<b>Port</b>	Port number of the Registrar server. Value range: 0 or 1024 to 65535, default value: 5060
<b>Reregistration Interval (sec)</b>	Interval (in seconds) at which the registration is repeated. Value range: 30 to 86400, default value: 300
<b>Outbound Proxy/Inbound Proxy</b>	
<b>Use Provider Outbound/Inbound Proxy</b>	Activation of the outbound proxy: Some redundancy scenarios (e.g., with OpenScape Branch Proxy) require the handling of SIP signaling via an outbound proxy. Activation of the inbound proxy: In some redundancy scenarios (e.g., with OpenScape Voice), the incoming signaling occurs from a separate SIP server (inbound proxy). Default values: disabled in both cases
<b>IP Address / Host name</b>	Host name or IP address of the outbound or inbound proxy.
<b>Port</b>	Port number of the outbound or inbound proxy. Value ranges: 0 or 1024-65535

Parameter Description of Tabs:

- **Add SIPQ-Interconnection User**
- **Edit SIPQ-Interconnection User**
- **Delete SIPQ-Interconnection User**

Parameters	Description
UserId	Entry of the user ID for access to the SIP server.
Authorization name / Realm	Entry of the authorization name or realm for access to the SIP server.
Password	Entry of the password for access to the SIP server.
Confirm Password	Repetition of the password for access to the SIP server.

### 27.3.6.9 Voice Gateway > Native SIP Server Trunk

The parameters for the 10 possible external Native SIP routes are defined here. Any external SIP server can be connected via these routes.

Parameter Description of Tabs:

- **Add Native SIP Server Trunk**
- **Edit Native SIP Server Trunk**
- **Delete Native SIP Server Trunk**

Parameters	Description
Base Template	Template to be used as a base.
Trunk Name	Name of the external SIP server (template name).
Enable Trunk	The connection to the external SIP server is activated. Default value: disabled
Trunk Identifier in System	Choice of 10 external Native SIP connections. Grayed out items are occupied by already configured ITSPs (max 8 ITSPs possible - in this case, there are 2 Native SIP connections left).
Remote Domain Name	Host name or IP address of the external SIP server. The value is typically identical to the value at <b>IP Address / Host name</b> .
Transport protocol	Selection of the UDP or TCP protocol.
<b>SIP Server</b>	
IP Address / Host name	Host name or IP address of the external SIP server.
Port	SIP port of the external SIP server. Value range: 0 or 1024 to 65535, default value: 5060

Parameter Description of Tabs:

- **Add Native SIP Server Trunk User**
- **Edit Native SIP Server Trunk User**
- **Delete Native SIP Server Trunk User**



Parameters	Description
<b>Userld</b>	Entry of the user ID for access to the SIP server.
<b>Authorization name</b>	Entry of the authorization name for access to the SIP server.
<b>Password</b>	Entry of the password for access to the SIP server.
<b>Confirm Password</b>	Repetition of the password for access to the SIP server.

## 27.3.7 Station

Functions for all stations are grouped together under **Subscriber**. These include the name and phone number of the subscriber, for instance, as well as key programming information.

### 27.3.7.1 Station > Station > UP0 Stations

Parameter Description of Tabs:

- **Change Station**

Parameters	Description
<b>Call no</b>	Internal call number of the station.
<b>DID</b>	DID number of the station.
<b>First Name</b>	Freely selectable first name for the station. Value range: max. 16 characters, no umlauts or special characters
<b>Last Name</b>	Freely selectable last name for the station. Value range: max. 16 characters, no umlauts or special characters
<b>Display</b>	Freely selectable name for the station. By default, it is created using the First Name and Last Name parameters depending on display name algorithm. Value range: max. 16 characters, no umlauts or special characters
<b>Name</b>	Freely selectable name for the station. Value range: max. 16 characters, no umlauts or special characters
<b>Clip/Lin</b>	Sequence of digits to be displayed at the called party instead of the actual number for outgoing external calls (e.g., for E911 emergency services in the USA) Value range: max. 16 digits
<b>Active</b>	Indicates whether the station is operational.
<b>Device type</b>	Displays the device associated with the subscriber.
<b>Fax Call no.</b>	If a fax box has been set up (e.g., with the UC clients myPortal for Desktop or myPortal for Outlook), the fax number at which fax messages from internal locations can be received by the subscriber should be entered here.

Parameters	Description
<b>Fax DID</b>	If a fax box has been set up (e.g., with the UC clients myPortal for Desktop or myPortal for Outlook), the fax number at which fax messages from external locations can be received by the subscriber should be entered here.
<b>Access</b>	Displays the physical interface at which the device is connected.
<b>ITSP Loc-ID</b>	The ITSP Location ID of a station.
<b>Search</b>	You can also have selected subscribers displayed by entering a search term in the <b>Search</b> fields and pressing the Return key. The subscribers who match the search term are displayed. If you leave all the <b>Search</b> fields empty and press the Enter key, all subscribers will be listed again.
<b>Items per page</b>	Selection to determine whether 10, 25, 50 or 100 items are to be displayed per page.
<b>Buttons</b>	
Blue arrow in the <b>Call no</b> column	Brings up the page with the <b>Edit station parameters, Edit station flags, Edit workpoint client data</b> and <b>Edit Group/CFW</b> tabs.
>	Moves one page forward.
<	Moves one page back.
>	Moves to the end of the list.
<	Moves to the beginning of the list.

Parameter Description of Tabs:

- **UP0 Master/Slave**

This tab appears only for OpenScape Business X8, since the slave ports are managed dynamically in this system. For OpenScape Business X1/X3/X5, the slave ports are assigned statically (i.e., are fixed)

Parameters	Description
<b>Call no</b>	Internal call number of the station.
<b>DID</b>	DID number of the station.
<b>Name</b>	Freely selectable name for the station. Value range: max. 16 characters, no umlauts or special characters
<b>Access</b>	Displays the physical interface at which the device is connected.
<b>Add Slave Zone</b>	If this check box is selected, a slave port is preassigned to the selected master port. After saving the selection with <b>Apply</b> the call number, DID number and name of the slave system telephone can be configured in advance.  When the slave system telephone is then connected to the slave adapter of the master system telephone, it is assigned the previously selected slave port. If the slave system telephone is connected without a predefined slave port, the next available port (as of port 384) is automatically used.
<b>Delete Slave Zone</b>	If this check box is selected, the preconfiguration of the slave system telephone is deleted.  If a slave system telephone is already connected to the slave adapter of the master system telephone, the check box is grayed out, and the preconfiguration cannot be deleted.

Parameters	Description
<b>Search</b>	You can also have selected subscribers displayed by entering a search term in the <b>Search</b> fields and pressing the Return key. The subscribers who match the search term are displayed. If you leave all the <b>Search</b> fields empty and press the Enter key, all subscribers will be listed again.
<b>Items per page</b>	Selection to determine whether 10, 25, 50 or 100 items are to be displayed per page.
<b>Buttons</b>	
>	Moves one page forward.
<	Moves one page back.
>	Moves to the end of the list.
<	Moves to the beginning of the list.

Parameter Description of Tabs:

- **Device Info**

Parameters	Description
<b>Call no</b>	Internal call number of the station.
<b>Name</b>	Station name.
<b>Device type</b>	Displays the device type associated with the station.
<b>Current SW version</b>	Software version of the associated device (if available).
<b>HW version</b>	Hardware version of the associated device (if available).
<b>Items per page</b>	Selection to determine whether 10, 25, 50 or 100 items are to be displayed per page.
<b>Buttons</b>	
>	Moves one page forward.
<	Moves one page back.
>	Moves to the end of the list.
<	Moves to the beginning of the list.

### 27.3.7.2 Station > Station > IP Clients

Parameter Description of Tabs:

- **Change Station**

Parameters	Description
<b>Call no</b>	Internal call number of the station.
<b>DID</b>	DID number of the station.
<b>First Name</b>	Freely selectable first name for the station. Value range: max. 16 characters, no umlauts or special characters

Parameters	Description
<b>Last Name</b>	Freely selectable last name for the station. Value range: max. 16 characters, no umlauts or special characters
<b>Display</b>	Freely selectable name for the station. By default, it is created using the First Name and Last Name parameters depending on display name algorithm. Value range: max. 16 characters, no umlauts or special characters
<b>Type</b>	Type of the station.
<b>Type: No Port</b>	This call number is not yet assigned to any station.
<b>Type: System Client</b>	A system client is an IP station that can use all the features of the communication system via CorNet-IP (formerly called HFA system client)
<b>Type: RAS User</b>	A RAS user (Remote Access Service user) is granted Internet access to the IP network via the ISDN connection. This allows the communication system to be remotely serviced and licensed.
<b>Type: SIP Client</b>	A SIP client is an IP station that uses the SIP protocol. It can access only limited functionality of the communication system via SIP.
<b>Type: Deskshare User</b>	A Deskshare User is an IP user who can log in at another IP system telephone (mobile login) and then use this phone as his or her own phone (including the call number).
<b>Clip/Lin</b>	Sequence of digits to be displayed at the called party instead of the actual number for outgoing external calls (e.g., for E911 emergency services in the USA)
<b>Active</b>	Indicates whether the station is operational.
<b>Fax Call no.</b>	If a fax box has been set up (e.g., with the UC clients myPortal for Desktop or myPortal for Outlook), the fax number at which fax messages from internal locations can be received by the subscriber should be entered here.
<b>Fax DID</b>	If a fax box has been set up (e.g., with the UC clients myPortal for Desktop or myPortal for Outlook), the fax number at which fax messages from external locations can be received by the subscriber should be entered here.
<b>ITSP Loc-ID</b>	The ITSP Location ID of a station.
<b>Search</b>	You can also have selected subscribers displayed by entering a search term in the <b>Search</b> fields and pressing the Enter key. The subscribers who match the search term are displayed. If you leave all the <b>Search</b> fields empty and press the Enter key, all subscribers will be listed again.
<b>Items per page</b>	Selection to determine whether 10, 25, 50 or 100 items are to be displayed per page.
<b>Buttons</b>	
Blue arrow in the <b>Call no</b> column	Brings up the page with the <b>Edit station parameters</b> , <b>Edit station flags</b> , <b>Edit workpoint client data</b> and <b>Edit Group/CFW</b> tabs.
>	Moves one page forward.
<	Moves one page back.
>	Moves to the end of the list.
<	Moves to the beginning of the list.

Parameter Description of Tabs:

- **Device Info**

Parameters	Description
<b>Call no</b>	Internal call number of the station.
<b>Display</b>	Station name.
<b>Device type</b>	Displays the device type associated with the station.
<b>IP Address</b>	IP address of the associated device; direct link to the WBM of the IP telephone
<b>MAC Address</b>	MAC address of the associated telephone
<b>Current SW version</b>	Software version of the associated device (if available).
<b>HW version</b>	Hardware version of the associated device (if available).
<b>Items per page</b>	Selection to determine whether 10, 25, 50 or 100 items are to be displayed per page.
<b>Buttons</b>	
>	Moves one page forward.
<	Moves one page back.
>	Moves to the end of the list.
<	Moves to the beginning of the list.

### 27.3.7.3 Station > Station > Analog Stations

Parameter Description of Tabs:

- **Change Station**

Parameters	Description
<b>Call no</b>	Internal call number of the station.
<b>DID</b>	DID number of the station.
<b>First Name</b>	Freely selectable first name for the station. Value range: max. 16 characters, no umlauts or special characters
<b>Last Name</b>	Freely selectable last name for the station. Value range: max. 16 characters, no umlauts or special characters
<b>Display</b>	Freely selectable name for the station. By default, it is created using the First Name and Last Name parameters depending on display name algorithm. Value range: max. 16 characters, no umlauts or special characters
<b>Clip/Lin</b>	Sequence of digits to be displayed at the called party instead of the actual number for outgoing external calls (e.g., for E911 emergency services in the USA) Value range: max. 16 digits
<b>Active</b>	Indicates whether the station is operational.
<b>Device type</b>	Displays the device associated with the subscriber.

Parameters	Description
<b>Fax Call no.</b>	If a fax box has been set up (e.g., with the UC clients myPortal for Desktop or myPortal for Outlook), the fax number at which fax messages from internal locations can be received by the subscriber should be entered here.
<b>Fax DID</b>	If a fax box has been set up (e.g., with the UC clients myPortal for Desktop or myPortal for Outlook), the fax number at which fax messages from external locations can be received by the subscriber should be entered here.
<b>Access</b>	Displays the physical interface at which the device is connected.
<b>ITSP Loc-ID</b>	The ITSP Location ID of a station.
<b>Search</b>	You can also have selected subscribers displayed by entering a search term in the <b>Search</b> fields and pressing the Return key. The subscribers who match the search term are displayed. If you leave all the <b>Search</b> fields empty and press the Enter key, all subscribers will be listed again.
<b>Items per page</b>	Selection to determine whether 10, 25, 50 or 100 items are to be displayed per page.
<b>Buttons</b>	
Blue arrow in the <b>Call no</b> column	Brings up the page with the <b>Edit station parameters, Edit station flags, Edit workpoint client data</b> and <b>Edit Group/CFW</b> tabs.
>	Moves one page forward.
<	Moves one page back.
>	Moves to the end of the list.
<	Moves to the beginning of the list.

#### 27.3.7.4 Station > Station > ISDN Stations

Parameter Description of Tabs:

- **Change Station**

Parameters	Description
<b>Call no</b>	Internal call number of the station.
<b>DID</b>	DID number of the station.
<b>First Name</b>	Freely selectable first name for the station. Value range: max. 16 characters, no umlauts or special characters
<b>Last Name</b>	Freely selectable last name for the station. Value range: max. 16 characters, no umlauts or special characters
<b>Display</b>	Freely selectable name for the station. By default, it is created using the First Name and Last Name parameters depending on display name algorithm. Value range: max. 16 characters, no umlauts or special characters

Parameters	Description
<b>Clip/Lin</b>	Sequence of digits to be displayed at the called party instead of the actual number for outgoing external calls (e.g., for E911 emergency services in the USA) Value range: max. 16 digits
<b>Active</b>	Indicates whether the station is operational.
<b>Device type</b>	Displays the device associated with the subscriber.
<b>Fax Call no.</b>	If a fax box has been set up (e.g., with the UC clients myPortal for Desktop or myPortal for Outlook), the fax number at which fax messages from internal locations can be received by the subscriber should be entered here.
<b>Fax DID</b>	If a fax box has been set up (e.g., with the UC clients myPortal for Desktop or myPortal for Outlook), the fax number at which fax messages from external locations can be received by the subscriber should be entered here.
<b>Access</b>	Displays the physical interface at which the device is connected.
<b>ITSP Loc-ID</b>	The ITSP Location ID of a station.
<b>Search</b>	You can also have selected subscribers displayed by entering a search term in the <b>Search</b> fields and pressing the Return key. The subscribers who match the search term are displayed. If you leave all the <b>Search</b> fields empty and press the Enter key, all subscribers will be listed again.
<b>Items per page</b>	Selection to determine whether 10, 25, 50 or 100 items are to be displayed per page.
<b>Buttons</b>	
Blue arrow in the <b>Call no</b> column	Brings up the page with the <b>Edit station parameters</b> , <b>Edit station flags</b> , <b>Edit workpoint client data</b> and <b>Edit Group/CFW</b> tabs.
>	Moves one page forward.
<	Moves one page back.
>	Moves to the end of the list.
<	Moves to the beginning of the list.

### 27.3.7.5 Station > Station > DECT Stations > SLC Call number

Parameter Description of Tabs:

- **Change Station**

Parameters	Description
<b>Call no</b>	Internal call number of the station.
<b>DID</b>	DID number of the station.
<b>First Name</b>	Freely selectable first name for the station. Value range: max. 16 characters, no umlauts or special characters
<b>Last Name</b>	Freely selectable last name for the station. Value range: max. 16 characters, no umlauts or special characters

Parameters	Description
<b>Display</b>	Freely selectable name for the station. By default, it is created using the First Name and Last Name parameters depending on display name algorithm. Value range: max. 16 characters, no umlauts or special characters
<b>Clip/Lin</b>	Sequence of digits to be displayed at the called party instead of the actual number for outgoing external calls (e.g., for E911 emergency services in the USA) Value range: max. 16 digits
<b>Active</b>	Indicates whether the station is operational.
<b>Device type</b>	Displays the device associated with the subscriber. Base stations are shown as S0 stations.
<b>Access</b>	Displays the physical interface at which the device is connected.
<b>ITSP Loc-ID</b>	The ITSP Location ID of a station.
<b>Parameters</b>	Default view for all stations; do not change the settings
<b>Search</b>	You can also have selected subscribers displayed by entering a search term in the <b>Search</b> fields and pressing the Return key. The subscribers who match the search term are displayed. If you leave all the <b>Search</b> fields empty and press the Enter key, all subscribers will be listed again.
<b>Items per page</b>	Selection to determine whether 10, 25, 50 or 100 items are to be displayed per page.
<b>Buttons</b>	
Blue arrow in the <b>Call no</b> column	Brings up the page with the <b>Edit station parameters, Edit station flags, Edit workpoint client data</b> and <b>Edit Group/CFW</b> tabs.
>	Moves one page forward.
<	Moves one page back.
>	Moves to the end of the list.
<	Moves to the beginning of the list.

### 27.3.7.6 Station > Station > DECT Stations > DECT Stations

Parameter Description of Tabs:

- **Change Station**

Parameters	Description
<b>Call no</b>	Internal call number of the station.
<b>DID</b>	DID number of the station.
<b>First Name</b>	Freely selectable first name for the station. Value range: max. 16 characters, no umlauts or special characters
<b>Last Name</b>	Freely selectable last name for the station. Value range: max. 16 characters, no umlauts or special characters



Parameters	Description
<b>Display</b>	Freely selectable name for the station.  By default, it is created using the First Name and Last Name parameters depending on display name algorithm.  Value range: max. 16 characters, no umlauts or special characters
<b>Clip/Lin</b>	Sequence of digits to be displayed at the called party instead of the actual number for outgoing external calls (e.g., for E911 emergency services in the USA)  Value range: max. 16 digits
<b>Active</b>	Indicates whether the station is operational.
<b>Device type</b>	Displays the device associated with the subscriber.. DECT stations are shown as Comfort-PP.
<b>Fax Call no.</b>	If a fax box has been set up (e.g., with the UC clients myPortal for Desktop or myPortal for Outlook), the fax number at which fax messages from internal locations can be received by the subscriber should be entered here.
<b>Fax DID</b>	If a fax box has been set up (e.g., with the UC clients myPortal for Desktop or myPortal for Outlook), the fax number at which fax messages from external locations can be received by the subscriber should be entered here.
<b>Access</b>	Displays the physical interface at which the device is connected.
<b>ITSP Loc-ID</b>	The ITSP Location ID of a station.
<b>Search</b>	You can also have selected subscribers displayed by entering a search term in the <b>Search</b> fields and pressing the Return key. The subscribers who match the search term are displayed. If you leave all the <b>Search</b> fields empty and press the Enter key, all subscribers will be listed again.
<b>Items per page</b>	Selection to determine whether 10, 25, 50 or 100 items are to be displayed per page.
<b>Buttons</b>	
Blue arrow in the <b>Call no</b> column	Brings up the page with the <b>Edit station parameters</b> , <b>Edit station flags</b> , <b>Edit workpoint client data</b> and <b>Edit Group/CFW</b> tabs.
>	Moves one page forward.
<	Moves one page back.
>	Moves to the end of the list.
<	Moves to the beginning of the list.

### 27.3.7.7 Station > Station > IVM/EVM Ports > IVM

Parameter Description of Tabs:

- **Change Station**

Parameters	Description
<b>Call no</b>	Internal call number of the IVM port.
<b>DID</b>	DID number of the IVM port, if present.
<b>First Name</b>	Freely selectable first name for the station. Value range: max. 16 characters, no umlauts or special characters
<b>Last Name</b>	Freely selectable last name for the station. Value range: max. 16 characters, no umlauts or special characters
<b>Display</b>	Freely selectable name for the station. By default, it is created using the First Name and Last Name parameters depending on display name algorithm. Value range: max. 16 characters, no umlauts or special characters
<b>Clip/Lin</b>	Sequence of digits to be displayed at the called party instead of the actual number for outgoing external calls (e.g., for E911 emergency services in the USA).
<b>Active</b>	Indicates whether the IVM port is operational.
<b>Device type</b>	For IVM, S0 stations are displayed.
<b>Access</b>	Displays the internal port for the IVM.
<b>ITSP Loc-ID</b>	The ITSP Location ID of a station.
<b>Station type</b>	"PhoneMail" must be selected for IVM; "Standard" should be set for the announcement function.
<b>Parameters</b>	Default view for all stations; do not change the settings (e.g., the "language" is not the language of voicemail announcements).
<b>Search</b>	You can also have selected IVM ports displayed by entering a search term in the <b>Search</b> fields and pressing the Return key. The IVM ports that match the search term are displayed. If you leave all the <b>Search</b> fields empty and press the Return key, all IVM ports will be listed again.
<b>Items per page</b>	Selection to determine whether 10, 25, 50 or 100 items are to be displayed per page.
<b>Buttons</b>	
Blue arrow in the <b>Call no</b> column	Brings up the page with the <b>Edit station parameters, Edit station flags, Edit workpoint client data</b> and <b>Edit Group/CFW</b> tabs.
>	Moves one page forward.
<	Moves one page back.
>	Moves to the end of the list.
<	Moves to the beginning of the list.

### 27.3.7.8 Station > Station > IVM/EVM Ports > EVM

Parameter Description of Tabs:

- **Change Station**

Parameters	Description
<b>Call no</b>	Internal call number of the voicemail port.
<b>DID</b>	DID number of the voicemail port, if present.
<b>First Name</b>	Freely selectable first name for the voicemail port. Value range: max. 16 characters, no umlauts or special characters
<b>Last Name</b>	Freely selectable last name for the voicemail port. Value range: max. 16 characters, no umlauts or special characters
<b>Display</b>	Freely selectable name for the voicemail port. By default, it is created using the First Name and Last Name parameters depending on display name algorithm. Value range: max. 16 characters, no umlauts or special characters
<b>Clip/Lin</b>	Sequence of digits to be displayed at the called party instead of the actual number for outgoing external calls (e.g., for E911 emergency services in the USA).
<b>Active</b>	Indicates whether the voicemail port is operational.
<b>Device type</b>	For EVM, S0 stations are displayed.
<b>Access</b>	Displays the internal port for the voicemail.
ITSP Loc-ID	The ITSP Location ID of a station.
<b>Station type</b>	"PhoneMail" must be selected for EVM; "Standard" should be set for the Company AutoAttendant.
<b>Parameters</b>	Default view for all voicemail ports; do not change the settings (e.g., the "language" is not the language of voicemail announcements).
<b>Search</b>	You can also have selected voicemail ports displayed by entering a search term in the <b>Search</b> fields and pressing the Return key. The voicemail ports that match the search term are displayed. If you leave all the <b>Search</b> fields empty and press the Return key, all voicemail ports will be listed again.
<b>Items per page</b>	Selection to determine whether 10, 25, 50 or 100 items are to be displayed per page.
<b>Buttons</b>	
Blue arrow in the <b>Call no</b> column	Brings up the page with the <b>Edit station parameters</b> , <b>Edit station flags</b> , <b>Edit workpoint client data</b> and <b>Edit Group/CFW</b> tabs.
>	Moves one page forward.
<	Moves one page back.
>	Moves to the end of the list.
<	Moves to the beginning of the list.

### 27.3.7.9 Station > Station > Virtual Stations

Parameter Description of Tabs:

- **Change Station**

Parameters	Description
<b>Call no</b>	Internal call number of the virtual station.
<b>DID</b>	DID number of the virtual station.
<b>First Name</b>	Freely selectable first name for the station. Value range: max. 16 characters, no umlauts or special characters
<b>Last Name</b>	Freely selectable last name for the station. Value range: max. 16 characters, no umlauts or special characters
<b>Display</b>	Freely selectable name for the station. By default, it is created using the First Name and Last Name parameters depending on display name algorithm. Value range: max. 16 characters, no umlauts or special characters
<b>Type</b>	Empty or virtual station (fixed display for Mobility Entry)
<b>Clip/Lin</b>	Sequence of digits to be displayed at the called party instead of the actual number for outgoing external calls (e.g., for E911 emergency services in the USA)
<b>Active</b>	Indicates whether the virtual station is operational.
ITSP Loc-ID	The ITSP Location ID of a station.
<b>Search</b>	You can also have selected subscribers displayed by entering a search term in the <b>Search</b> fields and pressing the Return key. The subscribers who match the search term are displayed. If you leave all the <b>Search</b> fields empty and press the Enter key, all subscribers will be listed again.
<b>Items per page</b>	Selection to determine whether 10, 25, 50 or 100 items are to be displayed per page.
<b>Buttons</b>	
Blue arrow in the <b>Call no</b> column	Brings up the page with the <b>Edit station parameters</b> , <b>Edit station flags</b> , <b>Edit workpoint client data</b> and <b>Edit Group/CFW</b> tabs.
>	Moves one page forward.
<	Moves one page back.
>	Moves to the end of the list.
<	Moves to the beginning of the list.

### 27.3.7.10 Station > Station > Station Parameters

Parameter Description of Tabs:

- **Edit station parameters**

Parameters	Description
<b>Stations - ...</b>	
<b>Type</b>	Type of the station.
<b>Call number</b>	Internal call number of the station.

Parameters	Description
<b>First Name</b>	Freely selectable first name for the station. Value range: max. 16 characters, no umlauts or special characters
<b>Last Name</b>	Freely selectable last name for the station. Value range: max. 16 characters, no umlauts or special characters
<b>Display</b>	Freely selectable name for the station. By default, it is created using the First Name and Last Name parameters depending on display name algorithm. Value range: max. 16 characters, no umlauts or special characters
<b>Direct inward dialing</b>	DID number of the station.
<b>Device type</b>	Displays the device associated with the subscriber.
<b>Clip/Lin</b>	Sequence of digits to be displayed at the called party instead of the actual number for outgoing external calls (e.g., for E911 emergency services in the USA) Value range: max. 16 digits
<b>Access</b>	Displays the physical interface at which the device is connected.
<b>Fax</b>	
<b>Call number</b>	If a fax box has been set up (e.g., with the UC clients myPortal for Desktop or myPortal for Outlook), the fax number at which fax messages from internal locations can be received by the subscriber should be entered here.
<b>Direct inward dialing</b>	If a fax box has been set up (e.g., with the UC clients myPortal for Desktop or myPortal for Outlook), the fax number at which fax messages from external locations can be received by the subscriber should be entered here.
<b>Mobility/Circuit/SFB</b>	
Type	Type of the station (drop-down list)
<b>Mobile/Circuit/Sfb call number</b>	Only for SIP clients and mobile users: For the One Number Service, this number is used for the authentication of DISA access via the mobile service. Enter the mobile phone number associated with the subscriber together with the dialout prefix (i.e., the CO code), e.g., 0017312345678).
<b>Web Feature ID</b>	The Web Feature ID defines how the subscriber should log in at the mobile web client or circuit user (user name). Choice between "no" (Mobility Entry only) and "automatic" (internal call number of the subscriber) or selection of the station number of the client or phone from the drop-down list.
<b>Parameters</b>	
<b>Station type</b>	Type of the connected device (drop-down list)
<b>Station type: Standard</b>	System telephones or analog telephones
<b>Station type: Fax</b>	Fax machine, e.g., no override possible
<b>Station type: Loudspeaker</b>	For paging via the a/b port

Parameters	Description
<b>Station type: Answering Machine</b>	<p>Only for analog: if an answering machine is connected to this interface, this setting enables a call to be taken over from the answering machine from any device even though the answering machine has already accepted the call. To do this, the terminal must be programmed with the internal call number of the analog station.</p> <p>Besides being selected for answering machines, this entry should also be selected for virtual ports where no physical equipment has been set up. This prevents the communication system from checking the operating status of the port.</p> <p>Only for virtual ports: If a station without access was configured as a type of answering machine in Manager E, the port must be additionally configured as a virtual port. Otherwise, it will not be visible as a station in the WBM.</p>
<b>Station type: P.O.T. MW LED</b>	<p>For standard analog telephones (P.O.T = Plain Old Telephone) with a message-waiting LED</p> <p>Not for U.S.</p>
<b>Station type: Door station with pulsed loop</b>	When using a pulsed loop device with the door opener function
<b>Station type: Modem</b>	Call override is not possible with this setting. It is intended for modems.
	When a fax or modem station is deleted (i.e., the call number and DID are deleted), the extension type must also be reset to the default (standard).
<b>Language</b>	Language for the menu control of the device (system telephone).
<b>Call signaling internal</b>	<p>Every station can be assigned one of a total of eight possible internal ringing tones here. This means that in addition to the external ringing tone, an internal ringing tone is assigned here and subsequently transmitted for internal calls.</p> <p>Default value: Ring type 1</p>
<b>Call signaling external</b>	<p>Three different ring types for signaling external calls can be selected here: – System Phones: Ring type 1 = External call (e.g., double ring), Ring type 2 = External call CO 2 (e.g., triple ring), Ring type 3 = External call CO 3 (e.g., short/long/short) – Analog telephones for Germany: Ring type 1 = External call, Ring type 2 = Automatic recall, Ring type 3 = Door bell ring – Analog telephones for other countries: Ring type 1 = External call, Ring type 2 = External call, Ring type 3 = External call</p> <p>Default value: Ring type 1</p>
<b>Class of Service (LCR)</b>	<p>A subscriber can only seize a route if his or her COS is greater than or equal to the LCR COS in the route table, i.e., a subscriber with a COS 7 cannot seize a route with COS 8. By default, all subscribers are entered with the maximum LCR Class of Service (15).</p> <p>Default value: 15</p>
<b>Hotline Mode</b>	Selection of the hotline options
<b>Hotline Mode: off</b>	Disables the hotline feature.
<b>Hotline Mode: Off-hook alarm after timeout</b>	The call to the hotline takes place after a predefined delay (off-hook alarm time), see Telephony/Basic Settings/System/Intercept-Attendant-Hotline
<b>Hotline, Mode: Hotline</b>	Enables the hotline feature. On lifting the handset, the connection to the hotline destination is established immediately, see Telephony/Basic Settings/System/Intercept-Attendant-Hotline
<b>Hotline</b>	For details on selecting hotline destinations, see Telephony/ Basic Settings/System/ Intercept-Attendant-Hotline

Parameters	Description
<b>Hotline: none</b>	No destination defined
<b>Hotline: Digits 1 to 6</b>	For details on hotline destinations, see Telephony/ Basic Settings/System/Intercept-Attendant-Hotline
<b>Payload Security</b>	Only for IP system clients: enable or disable the encryption of phone conversations (SPE). To do this, all stations involved must have SPE enabled.
<b>MWI protocol</b>	Selection of MWI protocol for analog stations. Available only for SLMAVx (OpenScape Business X8), 4SLAV onboard and SLAVx OpenScape Business X3,X5.
<b>MWI protocol: Comtel3</b>	Comtel 3 protocol selected. Default value.
<b>MWI protocol: High Voltage</b>	High Voltage protocol selected.
<b>Buttons</b>	
>	Moves to the next station. If the stations matching the search term entered in the <b>Search</b> fields were previously filtered, it is possible to move between only those specific stations.
<	Skips back one station.

Parameter Description of Tabs:

- **Edit station flags**

Parameters	Description
<b>Stations - ...</b>	
<b>Type</b>	Type of the station.
<b>Call number</b>	Internal call number of the station.
<b>Name</b>	Station name.
<b>Station flags</b>	
<b>Override class of service on</b>	When this flag is activated, the subscriber can intrude into (i.e., override) an internal subscriber's ongoing connection. The subscribers involved are notified of the busy override by a warning tone and a display message.  Default value: Disabled
<b>Override Do Not Disturb</b>	When this flag is activated, the following applies: when the subscriber calls a station for which Do Not Disturb has been activated, he or she can override Do Not Disturb. After five seconds, the call is signaled at the called station. If the flag is disabled, the Do Not Disturb function cannot be overridden. Subscribers who call a station for which Do Not Disturb has been activated receive the busy tone.  Default value: Disabled
<b>FWD external permitted</b>	When this flag is activated, the subscriber can activate call forwarding to an external destination. Charges incurred for the execution of an external call forwarding are allocated to the subscriber who activated the call forwarding.  Default value: Enabled
<b>Prevention of voice calling off</b>	When this flag is activated, the station can be called directly. This enables an internal call to be set up without lifting the handset. The loudspeaker on the called station is activated automatically in the process.  Default value: Enabled

Parameters	Description
<b>DISA class of service</b>	<p>When this flag is activated, external subscribers can activate or deactivate functions of the communication system via DISA (Direct Inward System Access) and set up outbound external connections just like any other internal subscribers. This also includes activating and deactivating call forwarding, the Do Not Disturb feature and the lock code, for example.</p> <p>Default value: Disabled</p>
<b>Transit allowed via Hook-on</b>	<p>When this flag is activated, the subscriber can transfer an external call to another external subscriber by hanging up. Example: The subscriber is the conference controller and hangs up: if there are other internal subscribers still in the conference, the longest participating internal subscriber automatically becomes the conference controller. If there are only external participants remaining in the conference, the conference is terminated, and all connections are cleared.</p> <p>Default value: Disabled</p>
<b>System telephone lock reset</b>	<p>When this flag is activated, the subscriber can reset the individual lock code of other internal subscribers to the default code.</p> <p>Default value: Disabled</p>
<b>CLIP analog</b> (only for analog devices)	<p>When this flag is activated, the caller's phone number is shown on the phone display of the analog station. As a prerequisite, the analog phone of the subscriber must support CLIP (Calling Line Identification Presentation).</p> <p>Default value: Enabled</p>
<b>MCID access</b>	<p>When this flag is activated, the subscriber can have malicious external callers identified via the ISDN Central Office. As a prerequisite, the "Trace call" (Malicious Call Identification, MCID) feature must have been applied for and activated by the network provider. After the "Trace call" feature has been activated by the network provider, the following must be noted: for each incoming call from the ISDN CO, the release of the connection to the called station is delayed for a specific timeout period after the caller hangs up. This timeout enables the called station to activate the "Trace call" feature. The ISDN trunk availability is somewhat reduced as a result.</p> <p>Default value: Disabled</p>
<b>Entry in telephone directory</b>	<p>When this flag is activated, the name and number of the subscriber will be displayed in the system directory (including ODS).</p> <p>Default value: Enabled</p>
<b>Editing the Telephone Number</b>	<p>When this flag is activated, the subscriber can edit the digits of the call number entered via the keypad before the digit transmission. This requires a system phone with a display.</p> <p>Default value: Disabled</p>
<b>No group ringing on busy</b>	<p>When this flag is enabled, the following applies: The status of the station with group ringing programmed (i.e., the primary station) determines whether or not group ringing occurs. If the primary station is free, all stations included in the group are called immediately. If call waiting is enabled at the primary station: all stations included in the group are called after a delay of 5 seconds. If the primary station cannot receive a call or if call waiting is inactive: group ringing does not take place.</p> <p>Default value: Disabled</p>



Parameters	Description
<b>Associated dialing/services</b>	<p>Associated dialing: when this flag is activated, the subscriber can dial a number on behalf of another internal subscriber as if that station itself were dialing. Associated services: When this flag is activated, the subscriber can control features on behalf of another internal subscriber as if that station itself were controlling these features. This includes activating and deactivating call forwarding, group ringing and the lock code, for example.</p> <p>Default value: Disabled</p>
<b>Call waiting rejection on</b>	<p>When this flag is activated, subscribers who are conducting a call are not informed about other incoming calls via a call waiting tone or a display message.</p> <p>Default value: Enabled</p>
<b>Discreet call</b>	<p>When this flag is activated, the subscriber can discreetly join an existing voice call of another internal subscriber. He or she can silently monitor the call and speak with the internal subscriber without the other party hearing this conversation. This is only possible in the case of a two-party call. Discreet calling is not possible with consultation calls or conferences.</p> <p>Default value: Disabled</p>
<b>Discreet Call Lock</b>	<p>When this flag is activated, the station cannot be called discreetly.</p> <p>Default value: Disabled</p>
<b>DTMF-based feature activation</b>	<p>Only relevant for Mobility Entry stations: This flag must be set in order to be able to activate features during a call (i.e., in the talk state). The code receiver remains active. (Attention: limited resources)</p> <p>Default value: Disabled</p>
<b>Headset</b>	<p>When this flag is activated, the station can be equipped with a headset that plugs into the handset connection. Setting the flag enables the user to accept a call by pressing a headset button on the system telephone without lifting the handset. When a headset is connected to the system telephone connection, it is recognized automatically by the communication system; an authorization enable is not necessary in this case. When this flag is set, calls cannot be released by pressing the speaker key; a disconnect key must be programmed so that calls can be released.</p> <p>Default value: Disabled</p>
<b>Last destination mailbox active</b>	<p>If this flag is activated and the called party is not available, the call is forwarded to the substitute mailbox, and the caller's number is displayed on the substitute telephone.</p> <p>Default value: Disabled</p>
<b>Call prio./immed. tone call wait.</b>	<p>When this flag is activated (Call priority/immediate tone call waiting), calls through this station are signaled with a higher priority to partners. The priority is set to be the same as the priority of external calls. In other words, the prioritized calls are thus queued before existing internal calls, but after existing external calls. Note that existing first calls (not waiting calls) are usually never displaced, regardless of their ring type. If the same priority is also to be set for an internal call in another node, then the station flag "Call prio./immed. tone call wait." (Area: Circuit flags, Call prio./immed. tone call wait.) must be likewise set for the corresponding trunk. If this flag is set, the caller receives a ring tone immediately instead of a busy tone. This has no impact on the acoustic signaling. The prioritized calls are still signaled like an internal call. This feature is important for phonemail connections.</p> <p>Default value: Disabled</p>

Parameters	Description
<b>Voice recording</b>	<p>If the flag is activated, the subscriber can activate voice recording during a call. In addition, the "Warning tone during voice recording" switch under Flags can be used to specify whether or not a warning tone should be output on starting the voice recording. Furthermore, a suitable Live Recording device must be configured under PhoneMail. If the IVM is to be used for voice recording, then the maximum length of the voice recording can be set via "IVM   Additional Settings/General", and the appropriate signaling method to be used before starting a voice recording (if any) can be defined.</p> <p>Default value: Disabled</p>
<b>Compress display data</b>	<p>When this flag is enabled, the display outputs are compressed for improved performance. If the display on a UP0/E terminal changes, the communication system only updates the data that differs from the previous display. If an application (e.g., Smartset/TAPI) is connected via an RS 232 adapter (data or control adapter), this feature must be deactivated. The flag must be deactivated for applications that obtain the call number information from the telephone's display, (i.e., uncompressed output with call number instead of compressed output with name). Names are generally displayed only when the flag "Calling ID only" under "Display name/call number" is deactivated.</p> <p>Default value: Enabled</p>
<b>Door release DTMF</b>	<p>If this flag is enabled, the station can open a door with the DTMF/MFV code signaling when a door relay is connected to the relevant port.</p> <p>Default value: Disabled</p>
<b>Autom. connection, CSTA</b> (only for OpenStage SIP telephones)	<p>When the flag is enabled, the following applies: speakerphone mode is activated on the associated SIP telephone when dialing or answering calls via myPortal or myAttendant. The information contained in the documentation of the SIP telephone must be observed, since additional settings on the SIP phone may be required for the proper use of the feature. When the flag disabled, the call setup occurs only after lifting the handset.</p> <p>Default value: Enabled</p>
<b>Disable handsfree microphone</b>	<p>If this flag is activated, the handsfree microphone cannot be used. This flag is only supported by OpenStage phones.</p> <p>Default value: Disabled</p>
<b>Forced Number Presentation</b>	<p>If this flag is activated, the caller's phone number appears on the display of the called party instead of his or her name.</p> <p>Default value: Disabled</p>
<b>Usage</b> (for specific countries only)	<p>This drop-down list can be used to configure the output current of the interfaces of an analog board (in mA, e.g., 27 mA for China).</p>
<b>Operating Mode</b>	<p>In this drop-down list, an operating mode can be selected for the subscriber line.</p>
<b>Payload Security</b> (only for TDM system telephones)	<p>If this flag and the <b>SPE Support</b> system flag are activated, the Signaling &amp; Payload Encryption (SPE) feature is supported for the selected subscriber(s). The signaling and payload data for this/these subscriber/s is encrypted. An option can be set to indicate in the display whether or not a part of a connection path to an IP station is encrypted (off = no information is displayed). The payload security setting does not work for any other telephones.</p> <p>Default value: Disabled</p>

Parameters	Description
<b>Missed Calls List</b>	When this flag is activated, the missed calls list is activated for the subscriber at his or her telephone (only for phones with a display).  Calls that were not answered by the subscriber are provided with a time stamp (time and date) and added to a chronologically sorted list. Only the calls which also contain a phone number or name are recorded. If a subscriber calls more than once, only the time stamp for the entry is updated, and a call counter for that caller is incremented.
<b>Central busy signaling</b>	This flag must be set (see also QSIG features) for subscribers who have busy signaling on a centralized communication system. Does not apply to the USA. The implementation of central busy signaling is contingent on a maximum number of 100 stations per node.
<b>Display of Emergency text</b>	If this flag is activated, a configurable Emergency text is shown on the phone's display in emergency mode.
<b>Call Supervision</b>	When this flag is activated, the subscriber can silently monitor (i.e., listen in on) the conversation of any internal subscriber. The microphone of the party listening in is automatically muted. The monitored subscriber is not notified via a signal tone or display message. When you start and end call monitoring, you may encounter a lapse of up to two seconds of the conversation. Default value: Disabled
<b>Buttons</b>	
>	Moves to the next station. If the stations matching the search term entered in the <b>Search</b> fields were previously filtered, it is possible to move between only those specific stations.
<	Skips back one station.

Parameter Description of Tabs:

- **Edit workpoint client data**

Parameters	Description
<b>Stations - ...</b>	
<b>Type</b>	Type of the station.
<b>Call number</b>	Internal call number of the station.
<b>Name</b>	Station name.
<b>Parameters</b>	
<b>Status message</b>	For system clients only: this flag activates the "keep-alive" mechanism for system telephones. If a system phone fails, for example, it is flagged as inactive after four minutes. The flag must not be enabled when setting up a system telephone as a home client or when using the "Short-Hold" feature. Disabling this flag reduces the message traffic between the communication system and the system telephones.
<b>Authentication active</b>	If you want the IP client to be able to identify himself/herself at the communication system with a password, authentication must be activated and a password set. This is an advantage especially for clients that are not connected to the internal LAN, but that dial in from outside. After speed upgrade or system restart, Authentication active checkbox will be activated for all SIP endpoints and will be greyed-out so the user cannot disable it, if at least one SIP station has the Internet Registration with internal SBC flag activated.
<b>New password</b>	Password for authentication.
<b>Confirm password</b>	Password to repeat the authentication.
<b>SIP User ID / Username</b>	Only for SIP clients: freely selectable user name for authentication of the SIP subscriber, e.g., "SIP-120". The value defined here must also be entered at the SIP telephone.

Parameters	Description
<b>Realm</b>	Only for SIP clients: freely selectable names for the associated zone, e.g., "OSBIZ-SIP". This value must be the same for all SIP clients. The value defined here must also be entered at the SIP telephone.
<b>Fixed IP address</b>	For SIP clients only: entering a fixed IP address ensures that only one SIP client can log on to the system with this IP address. If this flag is activated, the IP address and the call number are verified. If this flag is not activated, only the call number is verified.
<b>IP Address</b>	Only for SIP clients: IP address of the SIP client (e.g., the IP address of the SIP telephone)
<b>Type</b>	Only for system clients: A mobile IP client (Mobile option) is not permanently assigned to any IP phone. The call no. of a mobile IP client can be used by a subscriber to log on to any IP terminal (that permits this) via the logon procedure (*9419) (provided the option Mobile blocked is not activated).
<b>Type: Mobile</b>	Only for system clients: No IP device is permanently assigned to the subscriber. The feature is only supported from the third station port onwards.
<b>Type: Non-mobile</b>	Only for system clients: The call number is permanently assigned to the IP device of the subscriber. When using a WLx phone, the option Non mobile must be set before registering the WLx phone with the communication system.
<b>Type: Non-mobile and blocked</b>	Only for system clients: A subscriber cannot log into this IP device with a mobile system client.
<b>Blocked for Deskshare User</b>	Only for system clients: This system phone can be shared by multiple subscribers (Desksharing).
<b>Secondary system ID</b>	This parameter has two different functions: 1. For all stations: defines the multi-location gateway assigned to the station. 2. Only for system clients: If the "Emergency" flag has been set (under the "Stations/ IP Clients/Secondary Gateway") for networked systems, the node ID of the failover system for system clients can be entered here.
<b>Internet registration with internal SBC</b>	Enables the SIP@Home feature. This makes it possible for an external STUN-enabled SIP phone to register at OpenScape Business over the Internet and thus be used as an internal telephone.
<b>Buttons</b>	
>	Moves to the next station. If the stations matching the search term entered in the <b>Search</b> fields were previously filtered, it is possible to move between only those specific stations.
<	Skips back one station.

Parameter Description of Tabs:

- **Edit Group/CFW**

Parameters	Description
<b>Stations - ...</b>	
<b>Type</b>	Type of the station.
<b>Call number</b>	Internal call number of the station.
<b>Name</b>	Station name.
<b>Call forwarding</b>	

Parameters	Description
<b>Day destination</b>	Displays the call forwarding destinations for incoming external calls during the day (see the wizard User Telephony/Call Forwarding)
<b>Night destination</b>	Displays the call forwarding destinations for incoming external calls during the night (see the wizard User Telephony/Call Forwarding).
<b>Internal destination</b>	Displays the call forwarding destinations for incoming internal calls (see the wizard User Telephony/Call Forwarding).
<b>Class of Service</b>	
<b>Day</b>	Every subscriber can be assigned a class of service for day. There are 15 classes of service to choose from (see Telephony/Classes of Service).
<b>Night</b>	Every subscriber can be assigned one class of service for night. There are 15 classes of service to choose from (see Telephony/Classes of Service).
<b>Call Pickup</b>	
<b>Group</b>	Every station can be assigned to a call pickup group. You can choose between 32 call pickup groups (120 with OpenScape Business S; see also Incoming Calls / Call Pickup).
<b>Buttons</b>	
>	Moves to the next station. If the stations matching the search term entered in the <b>Search</b> fields were previously filtered, it is possible to move between only those specific stations.
<	Skips back one station.

### 27.3.7.11 Station > Station > UC Applications

The functions of the UC solutions UC Smart and UC Suite are shown here. It is recommended that the basic settings be configured under "Setup > Basic Installation> Basic Installation> Change preconfigured call and functional numbers".

Depending on the UC solution being used, different functions are displayed.

Parameter Description of Tabs:

- **Change Station**

Parameters	Description
<b>Call no</b>	Call number of the service
<b>DID</b>	DID number of the service
<b>First Name</b>	Freely selectable first name for the service. Value range: max. 16 characters, no umlauts or special characters
<b>Last Name</b>	Freely selectable last name for the service. Value range: max. 16 characters, no umlauts or special characters

Parameters	Description
<b>Display</b>	Freely selectable name for the service. By default, it is created using the First Name and Last Name parameters depending on display name algorithm. Value range: max. 16 characters, no umlauts or special characters
<b>Type</b>	Depending on the UC solution: UC Smart: MeetMe / Conference UC Suite: Auto-Attendant / Fax / Contact Center Fax / Park / MeetMe / Conference / Fax Group
<b>Clip/Lin</b>	Sequence of digits to be displayed at the called party instead of the actual number for outgoing external calls (e.g., for E911 emergency services in the USA) IMPORTANT: CLIP is not supported for UC fax. It is only supported for analog fax.
<b>Active</b>	Indicates whether the service is operational.
<b>ITSP Loc-ID</b>	The ITSP Location ID of a station.
<b>Search</b>	You can also have selected services displayed by entering a search term in the <b>Search</b> fields and pressing the Return key. The services that match the search term are displayed. If you leave all the <b>Search</b> fields empty and press the Return key, all services will be listed again.
<b>Items per page</b>	Selection to determine whether 10, 25, 50 or 100 items are to be displayed per page.
<b>Buttons</b>	
Blue arrow in the <b>Call no</b> column	Brings up the page with the <b>Edit station parameters, Edit station flags, Edit workpoint client data</b> and <b>Edit Group/CFW</b> tabs.
>	Moves one page forward.
<	Moves one page back.
>	Moves to the end of the list.
<	Moves to the beginning of the list.

### 27.3.7.12 Station > Station > Profiles/Templates

User profiles (with user parameters, station flags, Groups/RNA, etc.) can be set up here as an way to create default settings for multiple users simultaneously.

Parameter Description of Tabs:

- **Edit All Profiles**

Parameters	Description
<b>Profiles</b>	Displays the profile number.
<b>Name</b>	Input of any profile name.

Parameter Description of Tabs:

- **Display All Profile Users**

Parameters	Description
<b>Profiles</b>	Displays the profile number.
<b>Name</b>	Displays the profile name.
<b>Member Call no</b>	Displays the internal call number of the profile member.
<b>Member Name</b>	Displays the name of the profile member.

Parameter Description of Tabs:

- **Add/Delete Profile member**

Parameters	Description
<b>Profiles - ...</b>	Displays the profile number.
<b>Name</b>	Displays the assigned profile name.
<b>Profile Members</b>	
<b>Selection</b>	List of subscribers available in the system.
<b>Members</b>	List of subscribers assigned to the profile.
<b>Buttons</b>	
<b>Add</b>	Add selected subscribers from the selection list to the list of profile members.
<b>Delete</b>	Delete selected member from the list of profile members.

Parameter Description of Tabs:

- **Import/Export Profile**

Parameters	Description
<b>Load Profile via HTTP</b>	
<b>Remote File Name (PC File System)</b>	Load an existing profile file in XML format
<b>Export Profile via HTTP</b>	
<b>File name</b>	Display the file name under which the profile is output (XML format)
<b>Action</b>	Download the profile
<b>Buttons</b>	
<b>Reset Default Values</b>	The profile values for all subscribers assigned to this profile are reset to the default values.

Parameter Description of Tabs:

- **Import/Export All Profiles**

Parameters	Description
<b>Load All Profiles via HTTP</b>	
<b>Remote File Name (PC File System)</b>	Load an existing profile file. Multiple profiles may be stored in this file.
<b>Export All Profiles via HTTP</b>	

Parameters	Description
<b>File name</b>	Display the file name under which the profiles are stored.
<b>Action</b>	Download the profile in a profile file.
<b>Buttons</b>	
<b>Reset Default Values</b>	The profile values for all profiles and assigned subscribers are reset to the default values.

Parameter Description of Tabs:

- **Edit station parameters:** see > Station > Stations > Station Parameters
- **Edit station flags:** see > Station > Stations > Station Parameters
- **Edit Group/CFW:** see > Station > Stations > Station Parameters

### 27.3.7.13 Station > Station > DID Extensions

Displays an overview of the configured DID numbers with the associated subscribers.

Parameter Description of Tabs:

- **Display DDI Extensions**

Parameters	Description
<b>Call no</b>	Displays the call number of the station.
<b>Name</b>	Displays the name of the station.
<b>DID</b>	Displays the DID number of the station.
<b>(additional fields can be displayed)</b>	

### 27.3.7.14 Station > Station > Mobility Entry

It is recommended to set up mobile users via the "User Telephony > Mobile Phone Integration" wizard.

Parameter Description of Tabs:

- **Change Station**

Parameters	Description
<b>Call no</b>	Input of the internal extension number of the Mobility user (e.g., 777). This internal call number must not have already been assigned.
<b>DID</b>	Input of the internal DID number of the Mobility user. This internal DID number must not have already been assigned.
<b>First Name</b>	Freely selectable first name for the Mobility user. Value range: max. 16 characters, no umlauts or special characters



Parameters	Description
<b>Last Name</b>	Freely selectable last name for the Mobility user. Value range: max. 16 characters, no umlauts or special characters
<b>Display</b>	Freely selectable name for the Mobility user. By default, it is created using the First Name and Last Name parameters depending on display name algorithm. Value range: max. 16 characters, no umlauts or special characters
<b>Type</b>	Displays the type of Mobility user.
Device Type	Displays the system telephone type associated with the image file.
Clip/Lin	Sequence of digits to be displayed at the called party instead of the actual number for outgoing external calls (e.g., for E911 emergency services in the USA) Value range: max. 16 digits
Access	Displays the physical interface at which the device is connected.
<b>Mobile Callno</b>	Input of the mobile phone number. The entry must include the leading dialout prefix (i.e., the CO code), e.g., 0016012345678.
<b>Web Feature ID</b>	The Web Feature ID defines how the subscriber should log in at the mobile web client (user name). Choice between "no" (Mobility Entry user without myPortal to go) and "automatic" (internal call number of the subscriber or Mulap) or selection of the station number of the client or phone from the drop-down list.
<b>Search</b>	You can also have selected subscribers displayed by entering a search term in the <b>Search</b> fields and pressing the Return key. The subscribers who match the search term are displayed. If you leave all the <b>Search</b> fields empty and press the Enter key, all subscribers will be listed again.
<b>Items per page</b>	Selection to determine whether 10, 25, 50 or 100 items are to be displayed per page.
<b>Buttons</b>	
Blue arrow in the <b>Call no</b> column	Brings up the page with the <b>Edit station parameters</b> , <b>Edit station flags</b> , <b>Edit workpoint client data</b> and <b>Edit Group/CFW</b> tabs.
>	Moves one page forward.
<	Moves one page back.
>	Moves to the end of the list.
<	Moves to the beginning of the list.

Parameter Description of Tabs:

- **Secondary Gateway**  
Only for networked systems (multi-location)

Parameters	Description
<b>Call number</b>	Internal call number of the Mobility User.
<b>Name</b>	Name of the Mobility User.
<b>Node ID</b>	Input of the node ID via which the mobile subscriber is externally accessible.

### 27.3.7.15 Station > Station > Circuit User

Circuit users can be added only via the **Setup > Wizards > Circuit: Edit - Circuit user instance**

Parameter Description of Tabs:

- **Edit Subscriber**

Parameters	Description
<b>Callno</b>	Input of the internal extension number of the Circuit User (e.g., 777). This internal call number must not have already been assigned.
<b>DID</b>	Direct inward dialing number of the Circuit User.
<b>First Name</b>	Freely selectable first name for the station. Value range: max. 16 characters, no umlauts or special characters.
<b>Last Name</b>	Freely selectable last name for the station. Value range: max. 16 characters, no umlauts or special characters.
<b>Display</b>	Freely selectable name for the station. By default, is created using the First Name and Last Name parameters depending on display name algorithm. Value range: max. 16 characters, no umlauts or special characters.
<b>Type</b>	Displays the type of Circuit User.
<b>Circuit Call Number</b>	The Circuit User call number.
<b>Search</b>	You can also have selected subscribers displayed by entering a search term in the <b>Search</b> fields and pressing the Return key. The subscribers who match the search term are displayed. If you leave all the <b>Search</b> fields empty and press the Enter key, all subscribers will be listed again.
<b>Items per page</b>	Selection to determine whether 10, 25, 50 or 100 items are to be displayed per page.
<b>Buttons</b>	
Blue arrow in the <b>Call no</b> column	Brings up the page with the <b>Edit station parameters, Edit station flags, Edit workpoint client data</b> and <b>Edit Group/CFW</b> tabs.
>	Moves one page forward.
<	Moves one page back.
>	Moves to the end of the list.
<	Moves to the beginning of the list.

### 27.3.7.16 Station > Station > SfB User

Parameter Description of Tabs:

- **Edit Subscriber**

Parameters	Description
<b>Callno</b>	Input of the internal extension number of the Skype for Business Client Mobility User (e.g., 777). This internal call number must not have already been assigned.
<b>DID</b>	Direct inward dialing number of the Circuit User.
<b>First Name</b>	Freely selectable first name for the station. Value range: max. 16 characters, no umlauts or special characters.
<b>Last Name</b>	Freely selectable last name for the station. Value range: max. 16 characters, no umlauts or special characters.
<b>Display</b>	Freely selectable name for the station. By default, is created using the First Name and Last Name parameters depending on display name algorithm. Value range: max. 16 characters, no umlauts or special characters.
<b>Type</b>	Displays the type of Mobility User.
<b>SfB Call Number</b>	The Skype for Business Client call number.
<b>Search</b>	You can also have selected subscribers displayed by entering a search term in the <b>Search</b> fields and pressing the Return key. The subscribers who match the search term are displayed. If you leave all the <b>Search</b> fields empty and press the Enter key, all subscribers will be listed again.
<b>Items per page</b>	Selection to determine whether 10, 25, 50 or 100 items are to be displayed per page.
<b>Buttons</b>	
Blue arrow in the <b>Call no</b> column	Brings up the page with the <b>Edit station parameters</b> , <b>Edit station flags</b> , <b>Edit workpoint client data</b> and <b>Edit Group/CFW</b> tabs.
>	Moves one page forward.
<	Moves one page back.
>	Moves to the end of the list.
<	Moves to the beginning of the list.

### 27.3.7.17 Station > Station > Overview of Stations

Lists all stations of the communication system sorted by call number (default). Clicking on a different column heading sorts the list by the selected column in ascending order; a second click sorts it in descending order.

Parameter Description of Tabs:

- **Change Station**

Parameters	Description
<b>Call no</b>	Internal call number of the station.
<b>DID</b>	DID number of the station.
<b>First Name</b>	Freely selectable first name for the station. Value range: max. 16 characters, no umlauts or special characters
<b>Last Name</b>	Freely selectable last name for the station. Value range: max. 16 characters, no umlauts or special characters
<b>Display</b>	Freely selectable name for the station. By default, it is created using the First Name and Last Name parameters depending on display name algorithm. Value range: max. 16 characters, no umlauts or special characters
<b>Device type</b>	Displays the type of station.
<b>Active</b>	Indicates whether the station is operational.
<b>Access</b>	Displays the physical interface at which the device is connected.
<b>Search</b>	You can also have selected subscribers displayed by entering a search term in the <b>Search</b> fields and pressing the Return key. The subscribers who match the search term are displayed. If you leave all the <b>Search</b> fields empty and press the Enter key, all subscribers will be listed again.
<b>Items per page</b>	Selection to determine whether 10, 25, 50 or 100 items are to be displayed per page.
<b>Buttons</b>	
Blue arrow in the <b>Call no</b> column	Brings up the page with the <b>Edit station parameters</b> , <b>Edit station flags</b> , <b>Edit workpoint client data</b> and <b>Edit Group/CFW</b> tabs.
>	Moves one page forward.
<	Moves one page back.
>	Moves to the end of the list.
<	Moves to the beginning of the list.

### 27.3.7.18 Station > Key Programming

Parameter Description of Tabs:

- **Program Keys**

Key programming is supported only for UP0 phones and HFA clients. Search function (by Callno, DID, First Name, Last Name, Display and Device Type fields) is available.

Parameters	Description
<b>Selection list</b>	Selection of subscriber's telephone.
<b>Shift Layer</b>	If a key has been set up with the "Shift Layer" function, the second level can be programmed here
<b>telephone</b>	Clicking on the key area of the phone opens the current key assignment.
<b>Keypad</b>	Displays the key function (function key label)
<b>Key button</b>	Selection of the desired function

Parameter Description of Tabs::

- **Copy keypad for other stations**

Parameters	Description
<b>Copies the key layout from the station</b>	Selection of the station whose key layout is to be copied for the selected stations
<b>All stations</b>	Copy the key layout to all stations.
<b>Selection field</b>	Copy the key layout to the selected stations
<b>Station</b>	Displays the internal call number and the name of the station.
<b>Device Type</b>	Displays the phone type of the subscriber. Device type cannot be changed for already Active stations.
<b>Copy the device type from station</b>	Selection of the station whose device type is to be copied for the selected stations
<b>to the following station(s)</b>	Selection of the station(s) in which the device type will be copied. Filtering by the device type of the stations is available.

## 27.3.8 Cordless

Functions for the integrated cordless solution for the operation of cordless telephones (DECT phones) via the communication system are grouped together under **Cordless**. The base stations and DECT phones (internal stations with HFA features) are configured here.

### 27.3.8.1 Cordless > System-wide

Parameter Description of Tabs:

- **Edit system-wide data**

Parameters	Description
<b>CMI data</b>	
<b>System ID</b>	<p>Entry of the 8-digit, hexadecimal DECT system ID. This is supplied on purchasing the DECT system. It is composed as follows:</p> <p>1st. digit: E/ARC (Access Right Class)</p> <p>2nd.-5th. digit: EIC (Equipment Installer's Code)</p> <p>6th.-7th. digit: (FPN Fixed Part Number)</p> <p>8th digit (Fixed Part Subscriber, FPS)</p>
<b>Freq. band</b>	Selection of country-specific frequency band. By default, the frequency band assigned to the entered country code is displayed.
<b>Speech coding</b>	Displays the system-wide voice codec (a-law, $\mu$ -law).
<b>Encryption</b>	<p>Encryption is the encoding of the data at the air interface and can be activated or deactivated.</p> <p>Default: active</p>
<b>Login window</b>	<p>Opening time of the login window for the registration of DECT phones.</p> <p>The login window is opened by entering the code *94 2 19970707 and the password at a system telephone. The call numbers of the DECT phones to be registered are then entered in the Login window.</p> <p>Default: 10 minutes</p>
<b>Echo Handling</b>	
<p>These parameters can be used to disable the echo handling set under <b>Trunks &gt; Parameters/General Flags</b> for mobile stations on a node-wide basis. The settings are made in accordance with the line settings of the calls. Potential improvements by general deactivation or line-specific activation must be tested in individual cases.</p>	
<b>Echo Suppressor</b>	<p>The Echo Suppressor (ES) inserts an attenuator in the receive direction of the DECT phone, depending on its transmit level. If the echo suppressor is turned on in cases where there is loud extraneous noise, it is conceivable that the receive signal may be further dampened. This could adversely affect the clarity of the call. In the "<b>not active</b>" mode, the receive direction of the DECT phone is not attenuated when the DECT phone has a high transmit level. In the case of analog trunk switching and loud environments, this setting can offer improved clarity of the trunk station at the DECT phone.</p> <p>Default: Automatic</p>
<b>Echo Canceller</b>	<p>The Echo Canceller (EC) eliminates unwanted signal echoes caused by a 4/2-wire conversion (fork) on the land line. If the Echo Canceller is activated without an echo, errors may occur, since the Echo Canceller attempts to adapt to a non-existent echo. In the "<b>not active</b>" mode, the activation of this parameter is prevented, and the Echo Canceller is always off.</p> <p>Default: Automatic</p>
<b>Artificial Echo</b>	<p>The Artificial Echo Path (AE) echoes back an attenuated voice signal (24dB) from the land line to the remote subscriber. This may be needed in the case of an international connection, for example, to provide an inserted echo canceller with a certain preload. In the "<b>not active</b>" mode, the activation of this parameter is prevented, and the Artificial Echo is always off.</p> <p>Default: Automatic</p>

Parameters	Description
<b>PP Deviation Control</b>	Echoes often occur when VoIP calls are made using DECT phones. The "PP Deviation Control" function can be activated to suppress/minimize these echoes. This function affects all DECT handsets connected to the communication system. The activation or deactivation only takes affect for a handset when it is turned off and turned back on. In the " <b>not active</b> " mode, echo suppression does not work, and echoes can occur when VoIP connections are made using DECT handsets.  Default: not active
<b>Economic Mode</b>	
<b>Economic Mode</b>	The ECO mode can be enabled system-wide for all DECT phones. In ECO mode, the transmit power of DECT phones is either reduced by a fixed value (static) or every DECT phone adjusts its transmit power independently to the received signal strength (adaptive).  Default: not active
<b>Economic Mode: Off</b>	The ECO Mode is disabled system-wide.
<b>Economic Mode: On</b>	The ECO mode (static) is enabled system-wide. The transmit power of the DECT phones is reduced by a fixed value.
<b>Economic Mode: Adaptive</b>	The ECO mode (adaptive) is enabled system-wide. Every individual DECT phone adjusts its transmit power independently to the received signal strength. During a handover, the system first switches to the high transmit power and then reduces the transmit power, depending on the reception.

### 27.3.8.2 Cordless > SLC

Parameter Description of Tabs:

- **Change DECT Station**

Parameters	Description
<b>Call no</b>	Call number of the DECT phone.
<b>DID</b>	Direct inward dialing number of the DECT phone.
<b>Name</b>	Name of the DECT phone.
<b>Active</b>	Logon status of the DECT phone:  Green: The DECT phone is active.  Red: The board lockout switch was set for a logged-on DECT phone.  Yellow: The DECT phone was automatically logged off on changing the PIN.  Gray: No DECT phone has ever been logged on at this port.
<b>Mobile code</b>	PIN code to log on the DECT phone. The mobile code must be unique throughout the system.
<b>Access</b>	Name, number and slot of the S <sub>0</sub> extension cable.

Parameters	Description
Slot	Displays the slot of the plugged in SLC board.
<b>Buttons</b>	
Delete	The DECT phone is removed from the system. In other words, the call number, DID number and name are deleted, and the associated TDM user license is released.

Parameter Description of Tabs:

- **Add DECT Station**

Parameters	Description
System ID	If the communication system is not part of an internetwork (node ID = 0), the system identifier is preset to 1.  If the communication system belongs to an internetwork (node ID > 0), the system ID must match the node ID ( <b>Cordless &gt; Multi SLC &gt; System ID</b> ).
Slot	Slot of the plugged SLC board.
SLC No.	Unique system-wide ID number of the SLC board. Range of values: 1-15,17-31,33-47,....,127. Multiples of 16 are not allowed.
Number of DECT phones	Number of already configured DECT phones of this SLC board.
SLC Call number	Unique system-wide call number of the S <sub>0</sub> extension line.
Access	Name, number and slot of the S <sub>0</sub> extension cable.
<b>Add DECT Station</b>	
Number of DECT phones	If the number of DECT phones is less than the size allowed in the system (which depends on the version), an additional number of DECT phones can be added for this SLC board here.  The newly added DECT phones are displayed under the <b>Edit DECT Stations</b> .

### 27.3.8.3 Cordless > Multi-SLC

Parameter Description of Tabs:

- **Edit Multi-SLC**

Parameters	Description
SLC No.	Unique system-wide ID number of the SLC board. Range of values: 1-15,17-31,33-47,....,127. Multiples of 16 are not allowed.
Node ID	Displays the node ID (if configured). If the communication system is part of an internetwork, all configured SLC boards of the internetwork are displayed here.
SLC Call number	Unique system-wide call number of the S <sub>0</sub> extension line of the SLC board.



### 27.3.8.4 Cordless > Base Stations

Parameter Description of Tabs:

- **Edit base station**

Parameters	Description
<b>Slot</b>	Displays the slot in which the SLC board of base station is inserted. Slot 2 is displayed for the mainboard (SLUC).
<b>Type</b>	Type of base station. In the case of an SLC board, the type is only displayed; for SLUC, the type can be selected. If the type is changed from <b>No Port</b> to <b>Base station</b> , 16 DECT phones are automatically preconfigured, and an SLC networking line is set up.
<b>Type: Base station</b>	Base station connected.
<b>Type: No Port</b>	No base station connected.
<b>Name</b>	Name of the base station.
<b>Level</b>	Level of the base station. Range of values: 50% and 100%; default value: 100%
<b>Status</b>	Status of the base station.
<b>Master port</b>	For an SLC board, the ports to which the base station is connected are displayed. For an SLUC board, all ports with the connected terminal devices are displayed.

### 27.3.9 Incoming calls

Call Management (CM) functions are grouped together under **Incoming calls**. These include settings for groups, for instance, and call forwarding-no answer.

#### 27.3.9.1 Incoming Calls > Groups/Hunt groups

For the initial configuration of group calls and hunt groups, it is recommended that the **Group Call / Hunt Group** wizard be used.

Parameter Description of Tabs:

- **Edit Group Call Numbers**
- **Display Used Groups**
- **Display all group members**
- **Add group**
- **Delete group**
- **Edit group parameters**
- **Display members**
- **Add member**
- **Edit member order**

- **Check Basic MULAPs**
- **Check MULAP Preference**

Parameters	Description
<b>Index</b>	Consecutive number that is assigned by the communication system.
<b>Call no.</b>	Phone number of the group call, hunt group, basic MULAP, executive MULAP or voicemail group
<b>DID</b>	DID number of the group call, hunt group, basic MULAP, executive MULAP or voicemail group
<b>First Name</b>	Freely selectable first name for the group call, hunt group, basic MULAP, executive MULAP or voicemail group. Value range: max. 16 characters, no umlauts or special characters
<b>Last Name</b>	Freely selectable last name for the group call, hunt group, basic MULAP, executive MULAP or voicemail group. Value range: max. 16 characters, no umlauts or special characters
<b>Display</b>	Name of the group call, hunt group, basic MULAP, executive MULAP or voicemail group By default, it is created using the First Name and Last Name parameters depending on display name algorithm.
<b>Type</b>	Definition of the group type Default value: Group
<b>Type: Linear hunt group</b>	An inbound call is always signaled first at the first member of a hunt group. Further signaling is performed on the basis of the sequence in which the members are entered in the group table.
<b>Type: Cyclical hunt group</b>	An inbound call is always signaled first at the member that follows the subscriber who answered the last call. Further signaling is performed on the basis of the sequence in which the members are entered in the group table.
<b>Type: Group</b>	Group call of type Group: Incoming calls are simultaneously signaled at all available group members. Available group members are subscribers who are not busy. If all group members are busy, a call is signaled by a camp-on tone. Call signaling continues at all group members (camp-on tone at busy group members) even if the subscriber hangs up.
<b>Type: RNA</b>	Group call of type RNA: Incoming calls are simultaneously signaled at all group members. If a group member is busy, the entire group call is marked as busy (only the busy members are signaled for the incoming call). Callers of the group receive the busy signal.
<b>Type: Basic MULAP</b>	Incoming calls are indicated visually at all phones associated with the basic MULAP (Multiple Line Appearance). The subscriber can also set whether or not incoming calls should also be acoustically signaled for each individual member. The status of the Basic MULAP changes to busy and other callers hear the busy signal when a call is answered. The Basic MULAP phone number is shown on the called party's display for outgoing calls via the Basic MULAP trunk.
<b>Type: Executive MULAP</b>	You can configure Executive MULAPs if you want to use restricted executive and secretary functions. If a caller rings the Executive MULAP phone number, the call is visually signaled at all phones belonging to the Executive MULAP. Incoming calls are also signaled acoustically for members with secretary functions.

Parameters	Description
<b>Type: Call waiting</b>	Group call of type Call Waiting: Incoming calls are simultaneously signaled at all available group members. Available group members are subscribers who are not busy. A call is signaled by a camp-on tone for busy group members.
<b>Type: Voicemail</b>	Voicemail group: A voicemail group enables a specific group of subscribers to access voicemails. When a call is placed to the call number of a voicemail group, the call is sent directly to the voicemail box (i.e., the voicemail) of the group and not to the group members. After a voicemail is left in the voicemail box of the group, it is forwarded to the voicemail boxes of all members. All members receive the voicemail simultaneously. Whenever a member deletes a voicemail, this voicemail is also deleted from the voicemail boxes of all members and the voicemail box of the group. The personal voicemails of all members are not affected by this.
<b>Ring type</b>	Defines the acoustic signaling of incoming external calls to the group Default value: 1 Only the default setting is possible for analog phones. Changes have no effect.
<b>Ring type: 1</b>	Two rings
<b>Ring type: 2</b>	Three rings
<b>Ring type 3</b>	short-long-short ring
<b>Tel. directory</b>	When this flag is activated (Display Yes), the call number of the group appears in the internal directory. Default value: Enabled
<b>Group member</b>	
<b>Group</b>	Number (index) of the group
<b>Member</b>	Number (index) of the member within the group
<b>Call number</b>	Call number of the group member
<b>Name</b>	Name of the group member
<b>Parameters</b>	Enabled parameters of the group member
<b>Parameter: M</b>	Master (M): Basic MULAP: The member is master of the basic MULAP. Executive MULAP: The member has Executive functions.
<b>Parameter: R</b>	Acoustic call (R): Basic MULAP and Executive MULAP: Incoming calls are signaled acoustically.
<b>Parameter: A</b>	Automatic seizure outgoing (A): Basic MULAP: The Basic MULAP trunk is automatically selected for a call when you lift the handset. Executive MULAP: The Executive MULAP trunk is automatically selected for a call when you lift the handset.
<b>Parameter: K</b>	No automatic incoming call acceptance (K): Basic MULAP and Executive MULAP: An incoming call must be accepted by pressing the MULAP key.

Parameters	Description
<b>Parameter: P</b>	Automatic privacy release (P): Basic MULAP and Executive MULAP: You can release the seized MULAP line for a conference by pressing the MULAP key.
<b>MULAP key set up</b>	Indicates whether or not a MULAP key has been configured the group member.
<b>Route</b>	For an external member of the group, the route is displayed.
<b>Group</b>	
<b>Consistency Check</b>	Possible collisions due to the overlapping of masters of basic MULAPs or in the automatic outgoing seizure of basic MULAPs are displayed.

### 27.3.9.2 Incoming Calls > Group Members

Parameter Description of Tabs::

- **Edit member**
- **Delete member**

Parameters	Description
<b>Group</b>	Number (index) of the group
<b>Group member</b>	Number (index) of the group member
<b>Phone number</b>	Call number of the group member
<b>First Name</b>	Freely selectable first name for the group member. Value range: max. 16 characters, no umlauts or special characters
<b>Last Name</b>	Freely selectable last name for the group member. Value range: max. 16 characters, no umlauts or special characters
<b>Name</b>	Name of the group member By default, it is created using the First Name and Last Name parameters depending on display name algorithm.
<b>MULAP name</b>	MULAP (Multiple Line Appearance) group
<b>MULAP call no.</b>	MULAP group number
<b>Master (M)</b>	Basic MULAP: Activating this flag changes a member into a master of the Basic MULAP. If a master activates call forwarding, this feature applies to all members (phones) in the Basic MULAP.  Executive MULAP: Activating this flag assigns executive functions to a member. The Executive MULAP trunk is automatically selected for a call when you lift the handset. Incoming calls via the Executive MULAP phone number are only signaled visually.
<b>Acoustic call (R)</b>	Basic MULAP and Executive MULAP: When this flag is activated, incoming calls are signaled acoustically.  Default value: Enabled for all masters of a Basic MULAP. Activated for all members with the Secretary function of an Executive MULAP.

Parameters	Description
<b>Automatic seizure outgoing (A)</b>	<p>Basic MULAP: When this flag is activated, the Basic MULAP trunk is automatically called when the subscriber lifts the handset.</p> <p>Executive MULAP: When this flag is activated, the Executive MULAP trunk is automatically called when you lift the handset.</p> <p>Default value: Enabled for all masters of a Basic MULAP. Activated for all members with the Secretary function of an Executive MULAP.</p>
<b>No automatic incoming call acceptance (K)</b>	<p>Basic MULAP and Executive MULAP: When this flag is activated, you cannot answer an incoming call by lifting the handset. Answering an incoming call is possible only by pressing the MULAP key.</p> <p>Default value: Disabled</p>
<b>Automatic privacy release (P)</b>	<p>Basic MULAP and Executive MULAP: When this flag is activated, you can release the seized MULAP line for a conference by pressing the MULAP key. The release of this line is signaled to all other members by the flashing MULAP key. They can join the conference by pressing the MULAP key.</p> <p>Default value: Disabled</p>
<b>MULAP key set up</b>	<p>Basic MULAP: When this flag is activated, a MULAP key is programmed on the associated phone. You can press the key to set up an outgoing call via the Basic MULAP trunk. The Basic MULAP number appears on the called party's display.</p> <p>Executive MULAP: When this flag is activated, a MULAP key is programmed on the associated phone. You can press the key to set up an outgoing call via the Executive MULAP trunk. The Executive MULAP phone number appears on the called party's display.</p> <p>Default value: Enabled</p>
<b>Route</b>	For an external member of the group, the route is displayed.
<b>Type</b>	Definition of the group type

### 27.3.9.3 Incoming Calls > Team/top

For the initial configuration of Team and Top groups, it is recommended that the **Team Configuration** and **Executive / Secretary** wizards be used.

Parameter Description of Tabs::

- **Display All Team/top**
- **Display Used Team/top**
- **Add Team/top Group**
- **Edit Team/top Group**
- **Delete Team/top Group**
- **Edit Team/top Group**
- **Display Team/top Members**
- **Add Team/top Member**
- **Edit Team/top Member**
- **Delete Team/top Member**

- **Display Fax Boxes**
- **Add Fax Box**

Parameters	Description
<b>Index</b>	Consecutive number that is assigned by the communication system.
<b>First Name</b>	Freely selectable first name for the Team/Top group. Value range: max. 16 characters, no umlauts or special characters
<b>Last Name</b>	Freely selectable last name for the Team/Top group. Value range: max. 16 characters, no umlauts or special characters
<b>Name</b>	Name of th Team/Top group By default, it is created using the First Name and Last Name parameters depending on display name algorithm.
<b>Type</b>	Definition of the group type
<b>Type: Team</b>	A Team Group offers several convenient team functions. The station numbers of all team members are programmed on MULAP keys (trunk keys). Every team member can thus access all trunks (for instance, for call pickup) and can also conduct calls simultaneously via multiple trunks.
<b>Type: Top</b>	A Top Group offers convenient Executive and Secretary functions (Top function) for up to three executives and up to three secretaries.
<b>Key assignment to team</b>	Definition for the setup of MULAP keys of Team Group members
<b>Key assignment to team: to first/second console</b>	When this flag is activated, an automatic setup of MULAP keys occurs on the first or second add-on device (key module or BLF) of the Team telephone.
<b>Key assignment to team: to first free key</b>	When this flag is activated, an automatic setup of MULAP keys occurs on the first free key of the Team telephone.
<b>Key assignment to top</b>	Definition for the setup of MULAP keys of Top Group members
<b>Key assignment to top: to first/second console</b>	When this flag is activated, an automatic setup of MULAP keys occurs on the first or second add-on device (key module or BLF) of the Top telephone.
<b>Key assignment to top: to first free key</b>	When this flag is activated, an automatic setup of MULAP keys occurs on the first free key of the Top telephone.
<b>Group member</b>	
<b>Group</b>	Number (index) of the group
<b>Members</b>	Number (index) of the member within the group
<b>Type</b>	Definition of the member type
<b>Call no.</b>	Call number of the group member (changes in a MULAP group to ** Call no and is internally accessible under this ** Call no.)
<b>Name</b>	Name of the group member
<b>MULAP call no.</b>	MULAP group number
<b>MULAP DID</b>	DID number of the MULAP group
<b>MULAP name</b>	MULAP group name

Parameters	Description
<b>Ring type</b>	Defines the acoustic signaling of incoming external calls to the group Default value: 1 Only the default setting is possible for analog phones. Changes have no effect.
<b>Ring type: 1</b>	Two rings
<b>Ring type: 2</b>	Three rings
<b>Ring type 3</b>	short-long-short ring
<b>Tel. directory</b>	When this flag is activated (Display Yes), the call number of the group appears in the internal directory. Default value: Enabled
<b>Master (M)</b>	Team group: Activating this parameter turns a member of the Team group into a master of the group. If a master activates call forwarding, this feature applies to all members (phones) in the Team group. Top group: Enabling this flag assigns Executive functions to a member. The Executive MULAP trunk is automatically selected for a call on lifting the handset. Incoming calls via the associated Executive MULAP phone number are only signaled visually by default.
<b>Acoustic call (R)</b>	Team group and Top group: When this flag is activated, incoming calls are signaled acoustically. Default value: Enabled for all members of a Team group. Activated for all members with the Secretary function of a Top group.
<b>Automatic seizure outgoing (A)</b>	Team group and Top group: When this flag is activated, a call is automatically made via the MULAP trunk of this member on lifting the handset. Default value: Enabled
<b>No automatic incoming call acceptance (K)</b>	Team group and Top group: When this flag is activated, you cannot answer an incoming call by lifting the handset. Answering an incoming call is possible only by pressing the MULAP key. Default value: Disabled
<b>Automatic privacy release (P)</b>	Team group and Top group: When this flag is activated, you can release the seized MULAP line for a conference by pressing the MULAP key. The release of this line is signaled to all other members by the flashing MULAP key. They can join the conference by pressing the MULAP key. Default value: Disabled
<b>MULAP key set up</b>	Team group: When this flag is activated, a MULAP key is programmed on the associated phone. Pressing the key sets up an outgoing call via the MULAP trunk of the master. The MULAP station number of the master appears on the called party's display. Top group: When this flag is activated, a MULAP key is programmed on the associated phone. You can press the key to set up an outgoing call via the Executive MULAP trunk. The Executive MULAP phone number appears on the called party's display. Default value: Disabled for all members of a Team group. Enabled for all members of a Top group.
<b>MULAP type</b>	Definition of the MULAP type

Parameters	Description
<b>MULAP Type: Basic MULAP</b>	Incoming calls are indicated visually at all phones associated with the basic MULAP. The subscriber can also set whether or not incoming calls should also be acoustically signaled for each individual member. The status of the Basic MULAP changes to busy and other callers hear the busy signal when a call is answered. The Basic MULAP phone number is shown on the called party's display for outgoing calls via the Basic MULAP trunk.
<b>MULAP type: Executive MULAP</b>	All members of an Executive MULAP can be reached at the Executive MULAP phone number as well as at their personal station numbers.
<b>Fax Call no.</b>	Call number of the group member's fax box
<b>Fax DID</b>	Direct inward dialing number of the group member's fax box

#### 27.3.9.4 Incoming Calls > Call Pickup

Parameter Description of Tabs::

- **Edit names of call pickup groups**
- **Display Selected Group**
- **Edit Selected Group**

Parameters	Description
<b>Group</b>	
<b>Group</b>	Number (index) of the call pickup group Value range: 1 to 32 (120 for OpenScape Business S)
<b>Name</b>	Name of the call pickup group
<b>Station</b>	
<b>Call no.</b>	Call number of the internal station
<b>Name</b>	Name of the internal station
<b>Allocation Group X</b>	If the flag is activated, the station is assigned to the call pickup group X.
<b>Group</b>	Call pickup group to which this station is assigned.

#### 27.3.9.5 Incoming Calls > UCD

Parameter Description of the Tab:

- **Edit UCD Parameters**



Parameters	Description
<b>UCD flags</b>	
<b>Allow UCD applications</b>	When this flag is activated, the Uniform Call Distribution (UCD) feature is released throughout the system Default value: Enabled
<b>Agents permanently available</b>	When this flag is activated, all UCD agents are permanently available agents. A permanently available agent will then remain available for calls, faxes and e-mails even when he or she does not accept a call, fax or e-mail. Default value: Disabled
<b>Automatic wrap-up time</b>	
<b>Wrap-up time (cycles)</b>	The automatic wrap-up time for all UCD agents is defined on a system-wide basis in ring cycles, that is, in increments of five seconds. During the wrap-up time, an agent is temporarily removed from the call distribution in order to allow the agent some time to wrap up the call just completed. Default value: 0
<b>Priorities for internal calls</b>	
<b>Priorities, internal</b>	System-wide definition of priority for internal calls based on 10 priority levels (1 = high, 10 = low). Default value: 10
<b>Priorities for external calls</b>	
<b>Slot / line</b>	Displays the board, the slot and the number of the line (B channel). Priorities are assigned on the basis of trunks for external calls (per B channel), regardless of whether IP or TDM lines are involved.
<b>Priority</b>	Defines the priority for external calls received on the relevant line (B channel). The definition is based on 10 priority levels (1 = high, 10 = low). Default value: 1

Parameter Description of Tabs:

- **Display UCD Groups**
- **Edit UCD Group**

Parameters	Description
<b>Call number</b>	Call number of the UCD group
<b>MSN</b>	DID number of the UCD group
<b>Name</b>	Name of the UCD group
<b>Prim. ring cycles</b>	Definition of the primary ring cycle: This is defined in ring cycles, that is, in increments of five seconds. This setting specifies how long a call remains in the queue if not accepted by the agent longest in "available" state. The call is then forwarded to the next available agent. Default value: 3 Cycles

Parameters	Description
<b>sec. ring cycles</b>	Definition of the secondary ring cycle: This is defined in ring cycles, that is, in increments of five seconds. This setting specifies how long a call remains in the queue if not accepted by the next available agent.  Default value: 3 Cycles
<b>Queued Calls</b>	Definition of the maximum number of queued calls: When the maximum number of queued calls is reached, further calls can be forwarded to an overflow destination (which may be an external destination, another UCD group, an internal station or a group).  Default value: 10 (Default value of the last UCD group: 72)
<b>AICC</b>	Definition of the Automatic Incoming Call Connection (AICC). This setting applies to all agents in a UCD group, irrespective of whether or not the agent's phone features a headset.  Default value: No
<b>AICC: yes</b>	The agents in this UCD group can accept calls without any additional operating steps. An audible tone notifies the agent via the headset about an incoming call that is then automatically put through.
<b>AICC: no</b>	The agents in this UCD group can accept incoming calls only when using conventional operations (for example, by lifting the handset).
<b>Ann. change</b>	Definition of possible announcement changes  Default value: once
<b>Ann. change : single</b>	The queued caller will receive a one-time announcement.
<b>Ann. change : cyclical</b>	The last announcement and the second to last announcement in the configuration are repeated cyclically.
<b>Overflow time</b>	Definition of the overflow time in seconds: If a queued call is not accepted by the UCD application within the overflow time, the call is processed further by the communication system in accordance with the Call Management specifications.  This setting is relevant only when an external UCD application is connected.  Default value: 600
<b>Announcement Delay Time</b>	Definition of the announcement delay in seconds: after this time has elapsed, a queued caller receives an announcement.  Default value: 0

Parameter Description of the Tab:

- **Edit UCD Group Parameters**

Parameters	Description
<b>Dest. index</b>	For each UCD group, up to seven destinations (index 1 to 7) for announcements can be defined. The announcements of the destinations are played to the queued caller sequentially.
<b>Announcement equipment</b>	Announcement for the relevant destination index.
<b>Wait time</b>	The announcement can be played either cyclically (max 9 cycles with 5 sec each = 45 sec) or in an continuous loop. After this time, the announcement of the next index is played to the caller in the queue (not in the case of a <b>continuous</b> loop). Default value: endless

Parameter Description of the Tab:

- **Add-Delete UCD Group Members**

Parameters	Description
<b>Selection</b>	List of all UCD agent IDs. The UCD agent IDs do not correspond to the call numbers in the communication system.
<b>Members</b>	List of UCD agent IDs of the selected UCD group
<b>Buttons</b>	
<b>Add</b>	Adds the selected UCD agent IDs of the UCD group.
<b>Delete</b>	Deletes the selected UCD agent IDs from the UCD group.

Parameter Description of the Tab:

- **Assign Stations**

Parameters	Description
<b>Agent ID</b>	List of UCD agent IDs of the selected UCD group.
<b>Stations</b>	List of stations that can be assigned to the UCD agent IDs of the UCD group.

### 27.3.9.6 Incoming Calls > Call Forwarding

Parameter Description of Tabs::

- **Call dest. list - Definition**

Parameters	Description
<b>Call dest. list</b>	Selection of the call destination list to be processed. Value range: 1 to 740
<b>Edit Call Forwarding</b>	
To find a call destination faster, you can also enter one or more digits in the <b>Target 1 - Target 4</b> fields. This takes you directly to the list item that starts with the specified string of digits. It is also possible to enter a character string.	
<b>Target 1 - 4: No entry</b>	The call destination is skipped.

Parameters	Description
<b>Target 1 - 4: External destination</b>	Route and external phone number with CO access code.
<b>Target 1 - 4: * Dialed station</b>	Called subscriber.
<b>Target 1 - 4: ** User-defined</b>	Destination of call forwarding after timeout (if configured).
<b>Target 1 - 4: #9 System search</b>	Next available station (except for Executive extensions).
<b>Target 1 - 4: #201 - #260</b>	Call Distribution (UCD Group).
<b>Target 1 - 4: #801 - #817</b>	Ann. device.
<b>Target 1 - 4: 100, 101, ...</b>	Call number of a subscriber or a group (e.g., voicemail box)
<b>Call forwarding starts after</b>	Time after which a call is forwarded to the next call destination. For UCD groups, call forwarding is based on the mechanisms of the primary and secondary call cycles (see UCD groups).  Range of values: 5/10/15/...75 s; default value: 15 s
<b>Call Forwarding</b>	The call is immediately forwarded to the next call destination "on busy".  Default value: enabled
<b>Secondary bell</b>	
<b>Second ringer destination</b>	Additional internal station at which the call is also signaled or an actuator (relay) of an actuator/sensor assembly for a common ringer (night bell).
<b>Second ringer type</b>	The call can be signaled at the station immediately or after the entire call forwarding time has expired.  Default value: Immediately

Parameter Description of Tabs::

- **Call dest. list - Assignment**

Parameters	Description
<b>Call no</b>	Call number of the subscriber or group.
<b>Name</b>	Name of the subscriber or group.
<b>Type</b>	Subscriber Type, e.g., U <sub>P0</sub> , system client, AB, ISDN, SIP.
<b>Day</b>	Call destination list number to be used for incoming external calls during business hours (day service)  Default value: 14

Parameters	Description
<b>Night</b>	Call destination list number to be used for incoming external calls during night service Default value: 15
<b>Internal</b>	Number of the call destination list for incoming internal calls Default value: 16
<b>Search</b>	Entering a search term in the <b>Call no</b> or <b>Name</b> search fields and then pressing the return key causes all hits containing the specified search term to be displayed. For example, entering the call number 521 would display the matches +495213535 and +498967521, and entering the term co as the name would display Collins, Mcoin and Branco.  Pressing the return key with nothing entered in any of the search fields causes all entries to be displayed.

Parameter Description of Tabs:

- **Members of dest. list**

Parameters	Description
<b>Show all members with call destination list</b>	Displays all subscribers or groups that are using the selected call destination list.

Parameter Description of Tabs:

- **Assign call destination lists**

Parameters	Description
<b>Call dest. list</b>	Selects the call destination list to which subscribers are to be assigned. Value range: 1 to 740
<b>Day</b>	Call destination list to be used for incoming external calls during business hours (day service)
<b>Night</b>	Call destination list to be used for incoming external calls during night service
<b>Internal</b>	Call destination list for incoming internal calls
<b>Call dest. lists</b>	
<b>Selection</b>	List of all subscribers.
<b>Members</b>	List of subscribers to whom the call destination list is assigned.
<b>Buttons</b>	
<b>Add</b>	Transfers the selected subscribers from the Selection window to the Members window.
<b>Delete</b>	Deletes the selected subscribers from the Members window.

## 27.3.10 Trunks/Routing

The functions for trunks and routes are grouped together under **Trunks/Routing**.

## 27.3.10.1 Trunks/Routing > Trunks

Parameter Description of Tabs:

- **Display all lines**
- **Change Route**

Parameters	Description
<b>Trunk</b>	Display of the physical CO trunk connected to the communication system.
<b>Box-SI-Pt-Li or Box/Slot/Port/Line</b>	Displays the card type and the slot and port number (physical port) where a specific trunk is connected to the communication system.
<b>Code</b>	Display or setup of the seizure code. On entering this number, the communication system seizes the trunk assigned to it. It is used to test the trunk or to program a line key.
<b>Route</b>	Display or selection of the route that is assigned to the trunk (none or Trk. Grp 1 to Trk. Grp 12). If "none" is set in this column for an active trunk, system behavior will not be stable. Also, the system can receive a call on this trunk but the call cannot be forwarded.
<b>Status</b>	Displays the line status. Inactive lines are flagged with an asterisk.
<b>Type</b>	Displays the line type. Inactive lines are designated as "No Port".

Parameter Description of Tabs:

- **display ringing assignment all lines**

Parameters	Description
<b>Trunk</b>	Display of the physical CO trunk connected to the communication system.
<b>Box-SI-Pt-Li or Box/Slot/Port/Line</b>	Displays the card type and the slot and port number (physical port) where a specific trunk is connected to the communication system.
<b>Day call no.</b>	Displays the call number assigned for day service
<b>Day name</b>	Displays the name of the assigned call number for day service
<b>Night call no.</b>	Displays the call number assigned for night service
<b>Night name</b>	Displays the name of the assigned call number for night service

Parameter Description of Tabs:

- **Add line**

Parameters	Description
<b>Number</b>	Number of trunks to be added.

Parameter Description of Tabs:

- **Change direction**

Parameters	Description
<b>Line</b>	Displays the number of the line.
<b>outgoing</b>	Outgoing calls may be made on the line. IMPORTANT: Emergency calls can be made even if the flag is deactivated.
<b>incoming</b>	Incoming calls may be received on the line.

Parameter Description of Tabs:

- **change line**
- **delete line**

Parameters	Description
<b>Trunk</b>	Displays the lines number.
<b>Box/Slot/Port/Line</b>	Displays the physical port of the line (Box/Slot/Port/Line).
<b>Code</b>	Display or entry of the seizure code
<b>Route</b>	Display or selection of the route that is assigned to the trunk (none or Trk. Grp 1 to Trk. Grp 12).
<b>Ringing assignment per line</b>	
<b>Day call no.</b>	Day service call number for incoming connections that are not DID-capable
<b>Night call no.</b>	Night service call number for incoming connections that are not DID-capable

Parameter Description of Tabs:

- **Change ISDN Flags**

Parameters	Description
<b>Protocol: Description</b>	Each protocol template entry comprises the items Interface, Protocol and Additional info: S0 Basic access 2B+D via S0 interface, BRI Basic access 2B+D via U2B1Q interface (USA), S2 Primary multiplex access 30B+D, T1 Primary multiplex access 23B+D (USA)
<b>Logical/Physical</b>	Logical or physical numbering of the channels
<b>Slave B-channel neg: Master</b>	Setting of master/slave within Layer 3. For connections, one side must be set as the slave and the other side as the master.
<b>Up B-channel alloc: Down</b>	Definition of B-channel numbering (must be the same in both systems)
<b>S0 CHI format: S2M</b>	Protocol format CHI, to be defined as S0 (short format) or S2M (long format)
<b>Unsymmetric/Symmetric</b>	Symmetrical or non-symmetrical use of L3 protocol elements
<b>Automatic/Fixed</b>	Auto-negotiation or fixed assignment of symmetry
<b>1 CR length: 2</b>	Protocol format call reference length
<b>Alarm signaling</b>	Use of alarm signaling in the layer 3 protocol
<b>Protocol timers</b>	Use of the layer 3 timer
<b>PRI quickstart</b>	Use of the PRI QuickStart procedure
<b>IE_TNS</b>	Use of the information element Transit Network Selection
<b>IE_OSA</b>	Use of the information element Open Service Access
<b>CIDL</b>	Use of call and link ID signaling in the network
<b>Userside/Networkside</b>	Layer 2 protocol setting. Mirrored setting required on the opposite side
<b>Network/Subscriber</b>	Layer 2 protocol setting. Mirrored setting required on the opposite side
<b>PP/PMP</b>	Point-to-point or point-to-multipoint setting, only relevant for S0
<b>Permanent active</b>	Layer 2 permanently active
<b>Active TEI verify</b>	Enables TEI check

Parameters	Description
<b>Userside/Networkside</b>	Layer 1 protocol setting. Mirrored setting required on the opposite side
<b>PP/PMP</b>	Layer 1 protocol setting. Same settings required on both sides
<b>S Bus type: L</b>	Short/long bus (ranges)
<b>Permanent active</b>	Layer 1 protocol setting. Same settings required on both sides
<b>CRC4 check</b>	Layer 1 protocol setting, only relevant for S2M, same setting required on both sides
<b>CRC4 reporting</b>	Layer 1 protocol setting, only relevant for S2M, same setting required on both sides

Parameter Description of Tabs:

- **Change B-Channel**

Parameters	Description
<b>B channel</b>	Displays the B channel number.
<b>Outbound</b>	Outgoing calls may be made on the B-channel.
<b>Incoming</b>	Incoming calls may be received on the B-channel.

Parameter Description of Tabs:

- **Change Direction**

Parameters	Description
<b>Line</b>	Displays the line number.
<b>Outgoing</b>	Outgoing calls may be made on the line.
<b>Incoming</b>	Incoming calls may be received on the line.

### 27.3.10.2 Trunks/Routing > Trunk group

Parameter Description of Tabs:

- **Change Route**

Parameters	Description
<b>Route Name</b>	Route name. The entered name replaces the default route number in the Routes list.
<b>Seizure codes</b>	The assignment codes for each route are entered here. The routing codes entered must be collision free, both mutually and within the communication system's entire call number plan. Use the Check button to test for collisions. The seizure code is the code that causes the switching system to provide a line to the station that dialed the code. Seizure codes only work if LCR has not been activated.
<b>CO code (2nd. trunk code)</b>	A second trunk code (CO code) is defined if the communication system is a subsystem of another communication system or is networked with several other communication systems. It is only relevant for networking routes (route type = PABX). In this case, the second trunk code is the seizure code for the main system. Within a network, the codes for the trunk seizure, the route seizure code(s) and the second CO code must be configured uniformly. The default in Germany is 0.
<b>Gateway Location</b>	



Parameters	Description
<b>Country code</b>	Displays the country code of the own gateway location. Set via Basic Settings/Gateway/Gateway Locations
<b>Local area code</b>	Displays the local area code of the own gateway location. Set via Basic Settings/Gateway/Gateway Locations
<b>PABX number</b>	Displays the PABX number of the own gateway location. Set via Basic Settings/Gateway/Gateway Locations
<b>System station number - incoming</b>	
<b>Country code</b>	Used for digit analysis for incoming calls. Country code without leading zeros (e.g., 1 in the U.S., 49 in Germany)
<b>Local area code</b>	Used for digit analysis for incoming calls. Local area code without leading zeros (e.g., 89 for Munich)
<b>PABX number</b>	Used for digit analysis for incoming calls. PABX number (central company phone number, e.g., 777)
<b>Location number</b>	Used for digit analysis of public telephone numbers for outgoing connections. Checks the dialing information to determine whether the called destination number is located in the own system.
<b>System station number - outgoing</b>	
Info: Changes to outgoing PABX numbers must be coordinated with the network providers. (Clip no screening)	
<b>Country code</b>	Used for caller identification in outgoing calls. The country code without leading zeros (e.g., 1 in the U.S., 49 in Germany) is transmitted to the network. If no "PABX number outgoing" is entered, the "PABX number incoming" is automatically used.
<b>Local area code</b>	Used for caller identification in outgoing calls. The local area code specified here (without leading zeros, e.g., 89 for Munich) is transmitted to the network. If no "PABX number outgoing" is entered, the "PABX number incoming" is automatically used.
<b>PABX number</b>	Used for caller identification in outgoing calls. The PABX number specified here (central company phone number, e.g., 777) is transmitted to the network. If no "PABX number outgoing" is entered, the "PABX number incoming" is automatically used.
<b>Suppress Stn. Call No.</b>	Activating this flag suppresses the DID number in the caller ID.
<b>Overflow route</b>	
<b>Overflow route</b>	If all lines of the configured route are seized, an overflow to another route can be set. The overflow route applies only when LCR is disabled.
<b>Digit transmission</b>	
<b>Digit transmission</b>	The type of digit transmission is determined here for the selected route and is displayed as static (e.g., route table 6: en-bloc sending) text under Settings   Least Cost Routing   Dial plan after selecting the route table (see Route table drop-down list).
<b>Digit transmission: Digit-by-digit</b>	The digits are transmitted in sync with dialing.

Parameters	Description
<b>Digit transmission: en-bloc sending</b>	During en-block digit transmission (block dialing per route), the dialed digits are buffered by the communication system. Dialing only takes place when a timer has elapsed after the last digit has been dialed, when the end-of-dial code # has been entered or if an exact match in the dial rule is found. In the case of PRI in the USA block dialing to the central office is mandatory. LCR must be activated to be able to select en-bloc digit transmission. The type of digit transmission is automatically set to en-bloc digit transmission in the route table if at least one route of the LCR route table is configured with en-bloc digit transmission.
<b>Mobile Extension Number (MEX)</b>	
<b>MEX Number</b>	<p>If the ITSP being used supports the "Mobile Extension (MEX)" feature, the MEX number (8 positions, with only digits) provided by the ITSP must be entered here. This feature can only be used only with an Internet telephony DID connection (SIP like ISDN).</p> <p>It is used integrate mobile phones/smartphones into the communication system. The user of the mobile phone can be reached via the One Number Service under a single phone number, which is also communicated to the other party. When a subscriber is conducting a call with his or her mobile phone, the office number of the subscriber is displayed to the other party, so the number of the subscriber's mobile phone remains unknown. In addition, other internal subscribers can check the presence status of such subscribers even if they are currently talking on their mobile phones.</p>

Parameter Description of Tabs:

- **Change Routing Parameters**

Parameters	Description
<b>Routing flags</b>	
<b>Digit repetition on</b>	When an outgoing route is seized with digit repetition activated, the routing code is sent before the call number. This only applies if LCR is deactivated (see Settings   Least Cost Routing).
<b>Analysis of second dial tone / Trunk monitoring</b>	Analysis of Second Dial Tone alerts the communication system to detect an additional dial tone. This feature is used with tandem communication system applications. This evaluation is country-dependent, e.g., in Belgium after 00 and in France after 16 or 19. This is not relevant in Germany. This only applies to network providers who send a second dial tone for international calls.
<b>Intercept per direction</b>	This flag is necessary for QSIG networking. When this flag is set, the communication system checks whether a diversion request has been received by the remote station, or whether the communication system has implemented forward switching to the central intercept position. The remote station receives a message which advises whether or not a diversion should be implemented for this call. If intercept is activated for a route, all calls forwarded to this route are intercepted at this intercept position. To implement this feature, day and night numbers must be configured for each route (see Ringing assignment per line). Furthermore, an intercept position should not be entered for the day/night service (see Intercept/Attendant).

Parameters	Description
<b>Over. service 3.1 kHz audio</b>	<p>For all outgoing calls on ISDN, Over. service 3.1 kHz audio is the default setting. This is the standard transmission type for outgoing calls on an Integrated Services Digital Network (ISDN) line). A connection from the communication system to a digital CO with an analog modem must be identified as a data service. This flag should be set to avoid problems during FAX operation.</p> <p>In some cases, a network operator may not support the 3.1 kHz audio bearer service. This can cause the fax transmission to certain external telephone numbers to fail. One possible solution is to disable the <b>Over. service 3.1 kHz audio</b> flag.</p>
<b>Add direction prefix incoming</b>	When this option is activated on system telephones with incoming seizure, the call number display is supplemented by the route code.
<b>Add direction prefix outgoing</b>	<p>When this option is activated with outgoing seizure, the call number display is supplemented with the access code.</p> <p>Info: changing this parameter affects the caller identification and must therefore be coordinated with the network providers. (Clip no screening)</p>
<b>Call No. with international / national prefix</b>	<p>If this flag is enabled, the national or international code for the phone number (e.g., 02302....., 00492302...) must be added as a prefix for the ITSP.</p> <p>Default: enabled</p>
<b>Ring-back-tone to CO</b>	If this flag is set, a 'Ring-back tone' will be sent to the ISDN central office on an incoming call. This is a special protocol handling required for the provider Global One and Sovintel.
<b>Segmentation</b>	This area defines the system behavior when sending ISDN messages in which the maximum Layer 2 user data length (260 bytes) is exceeded.
<b>Segmentation: yes</b>	The message to be sent is split into 260-byte segments and sent individually. The receiving communication system must support the segmentation and collect and arrange the individual segments into a message.
<b>Segmentation: no</b>	Segmentation is not needed, since the underlying Layer 2 can transport messages of any length.
<b>Segmentation: Truncate Message</b>	The message to be sent is truncated to less than 260 bytes by eliminating the less important portions (such as names, for example) and then sent.
<b>Deactivate UUS per route</b>	User-to-User Signaling (UUS) can be deactivated with this flag. This suppresses the transmission of the name and phone number of the A station in the UUI element (user-to-user information, UUI) for external call forwarding (FWD ext.). This flag must be manually deactivated for Telefonica.
<b>Always use DSP</b>	If this flag is set, a connection to the Internet telephony service provider is only possible via a DSP (digital signal processor). If this flag is not set, then there is a Direct Payload connection to the Internet telephony service provider. This flag must be set for the route of the OpenScape Voice network. This flag may not be set in the case of fax transmissions (T.38) via an external device (e.g., Mediatrix 4102).
<b>Name in CO</b>	This flag is configured for CO that support calling party name.

Parameters	Description
<b>Analog trunk seizure</b>	Here various times can be selected which determine when dialing begins when using analog dial-up lines (MSI). If no pause is set, the communication system waits until it recognizes a dial tone. Note for Brazil: When using DTMF signaling from analog terminals in conjunction with analog trunks and digit outputting after dial tone detection, there might be problems with the toll restriction when the country code is set to Brazil. In this case, the DTMF signals from the analog terminals go directly to the analog trunks ("1A procedure" is not used). Because of this, the DTMF signals which are dialed before the dial tone is received are lost. Consequently, for such cases, least cost routing (LCR) must be enabled for the dialing method and toll restriction to operate properly at the device.
<b>Trunk call pause</b>	The CO call pause determines the period of time that elapses before a call is recognized as being completed once the user has hung up. This option applies only to MSI lines. For a trunk call with, for example, 1 second on and 4 seconds off, a trunk call pause of 6 seconds should be configured. In some COs, however, a 10-second ring pause applies. In such cases, a trunk call pause of 13 seconds must be programmed. Otherwise, no call diversion can be implemented. In the United States, this cycle is two seconds on, two seconds off, for a total of six seconds. The six-second option is the default, so you will not need to make any changes here. Setting range: 2 to 13 seconds.
<b>Type of Seizure</b>	This field specifies the criteria that apply if the communication system needs to seize an outgoing line.
<b>Type of seizure: cyclical</b>	The communication system starts its cyclical search for a free line with the next line number based on the last outgoing line seized in this route.
<b>Type of seizure: linear</b>	The communication system always begins its search with the lowest line number assigned to this route.
<b>Route type</b>	There are two options for Route type. The type of route can be set either as CO (Central Office) or as PABX (Private Automatic Branch Exchange).
<b>Route type: CO</b>	Lines assigned to this route are subject to toll restriction. When LCR is active, the toll restriction is regulated by the Dial plan (COS column).
<b>Route type: PABX</b>	Toll restriction is only performed if there is a second CO code assigned to this route. When LCR is active, the toll restriction is regulated by the Dial plan (COS column). The route type also has a bearing on the default text of the route name (see Routes) as well as on the procedure used for recognizing the dial tone on MSI lines.
<b>No. and type, outgoing</b>	The administrator can configure the "PABX number, incoming" and "PABX number, outgoing" separately, divided into portions for the country code, local area code and PABX number (= connection number in the local network). This is needed for the implementation of the "CLIP no screening" feature. If no "PABX number outgoing" has been configured, the communication system will always use the data of the "PABX number incoming" setting. In the case of an incoming seizure on an ISDN line, the communication system truncates the PABX number (left-aligned) from the received phone number and interprets remaining portion as the Direct Inward Dialing number. For call number information to the PSTN, the communication system automatically inserts the PABX number (or the portion defined in the configuration) as the leading portion of the call number. This does not apply to dialing information (destination address). The call numbers of internal stations that are sent to the remote station can be composed as follows:
<b>No. and type, outgoing: Unknown</b>	only DID number (default setting)
<b>No. and type, outgoing: PABX number</b>	PABX number + DID number

Parameters	Description
<b>No. and type, outgoing: Local area code</b>	+ Local area code + PABX number + DID number
<b>No. and type, outgoing: Country code</b>	Country code + Local area code + PABX number + DID number
<b>No. and type, outgoing: Internal</b>	Only for networked systems: number prefixes may not be added for closed numbering plans. Call number prefixes are suppressed here.
<b>Call number type</b>	The settings in the "No. and type, outgoing" area also affect calls coming from an extension in a partner system (a networked node). Due to this setting, the caller's number that is received from the networked node and forwarded to the Central Office is extended for the outgoing route.
<b>Call number type: Internal</b>	In this case, only the internal call number is transmitted. If the destination is an external station, either no number is transmitted or only that of the Attendant Console. The internal call number can be displayed when the destination is an internal station on another node.
<b>Call number type: Direct inward dialing</b>	In this case, only the DID number is transmitted. The internal call number is not provided for display at internal destinations in other nodes. The call number information is sufficient for external destinations.
<b>Call number type: Internal / DID</b>	This setting is useful for networking purposes. Both the internal call number and the DID call number are transmitted to the destination station. If an internal station is called within the network, the internal call number of the caller can be displayed for this station. If the internal destination station has activated call forwarding to an external destination, for example, a DID number can also be transmitted in this case.
<b>Rerouting</b>	
<b>Change route</b>	When this flag is turned on, it is also possible to route D-channel information via other routes. This option enables alternative routing via other routes. The option may be activated only when the call number plan is unambiguous. (Closed numbering or unique seizure codes in a network. The system making the request must also support this.). If rerouting is implemented, rerouting with change route active must also be set for the corresponding route. This option is only available for CorNet NQ networking, and must be activated in the same way in both networked communication systems.
<b>Route optimize active</b>	To optimize use of the B-channel, call forwarding can be performed on the basis of the protocol in accordance with the specification "Call Forwarding/Partial Rerouting". If partial rerouting is rejected, forward switching is used.
<b>Route optimize active: No</b>	When you select this option, Rerouting is deactivated. For call forwarding, the connection is always set up via two B-channels.
<b>Rerouting active: If route is known</b>	When you select this option, rerouting is only active if the route is known and a successful "handshake" procedure takes place between the two networked communication systems.
<b>Route optimize active: Always</b>	If the setup for the incoming call is coming in on the same route as the call forwarding destination route, the call will be rejected (call deflection feature is used) by the communication system if this option is activated. In case of networked systems this option Always must be activated in the same way in both networked communication systems.

Parameter Description of Tabs:

- **Special Parameter change**

Parameters	Description
<b>Numbering plan</b> Defines the Numbering Plan parameter in outgoing messages	
<b>Called Party Number</b>	System check = defined by the system; ISDN numbering plan, Private numbering plan, Unknown numbering plan = preset manually
<b>All others</b>	e.g., Calling Party No., Redirecting No, etc. System check = defined by the system. ISDN numbering plan, Private numbering plan, Unknown numbering plan = preset manually
<b>Site</b>	The Site (location) parameter determines how the Location parameter is set in the Q931 info element CAUSE and Progress Indicator. System check = defined by the system; alternatively, the setting "Private network and station" or "Always station" can be made manually.
<b>COLP</b>	If this flag is set, the number of the called party will be shown to the caller in the case of an external incoming CO connection. The calling party can see if the call has been forwarded or picked up by somebody else. This feature needs to be turned on by the central office as well. This feature is only available on digital Lines (BRI or PRI). If the flag is set and an external incoming call is forwarded or intercepted, the updated call number is signaled to the CO in the connect message output by the communication system. If the COLP feature is activated in the CO, the updated call number is also displayed for the caller.  Info: This flag does not affect the call number display for external outgoing connections.
<b>Notify send</b>	This message is used for the transmission of status information about the current connection. The message can be sent from the network as well as the subscriber side to notify the other party (network or subscriber) about an interrupted connection, for example, or that call forwarding is active. If the notify feature is not supported by the CO, the notify message can be suppressed by resetting this flag. If this option is activated, a "Notify" message is transmitted if a call is on hold or parked, for example. Notify send is only evaluated in the DSS1, NI1 and MCI protocols. In the SIP-Q, CorNet-NQ and QSIG the notification is always sent.
<b>without CLIP</b>	If this flag is set, the calling party information to the public network will be suppressed for outgoing calls on a BRI or PRI line. This flag can be activated or deactivated on a per route basis. In addition, the station has the option to suppress the called party information on a per call basis via an access code or the system telephone menu.
<b>No SETUP ACK.</b>	If this flag is set, the setup acknowledgment message from the communication system to the Central Office is suppressed. Relevant for special COs. Example: Fujitsu's Fetex150 COs.
<b>no DIV.LEG-Info</b>	If this flag is set, the standard diverting LEG information signal (call number of the redirecting party) is not sent to the CO. The DIV. LEG info should be suppressed if problems occur in the case of external call forwarding (CF ext.).

Parameters	Description
<b>With sending complete</b>	If this flag is set, the optional information "All digits sent" is output by the system once all dialed digits have been transmitted.
<b>Internal call like external</b>	If this flag is set, network-internal calls are acoustically signaled in the same way as external calls.
<b>Without CCNR</b>	If this flag is set, an incoming ISDN call with CCNR (Call Completion on No Reply) is signaled so that the system can accept a callback request. This means the caller can initiate a callback if the station does not reply. In some cases the message is not supported by the ISDN provider. In this case the switch must be activated to prevent the system from sending CCNR.

### 27.3.10.3 Trunks/Routing > QSIG Features

In a network consisting of several communication systems, any connection information that occurs (CDRC data) in the PBX satellite systems is sent to a fixed communication system in the network. For this purpose, the call number of the destination system (call number of central recording system) to which the connection data is sent is configured in each communication system.

Parameter Description of Tabs::

- **Edit QSIG Features**

Parameters	Description
<b>Own system data</b>	
<b>System number</b>	This data identifies your own communication system in the network. This data applies to both central busy signaling and connection data routing.  In a network consisting of several communication systems, each communication system has its own system number. If the communication system is networked with such communication systems, and you wish to use the QSIG features, the system numbers must also be administered here for compatibility reasons.  Value range: 1 to 255
<b>Group number</b>	In the communication systems, subscribers can be classified into groups, which then receive a unique group number. This type of grouping does not exist in the communication system. However, for compatibility reasons, the group number must also be administered here.  Value range: 1 to 40
<b>Inter-system busy signaling</b>	
<b>System no. target system</b>	This data defines a communication system where centralized busy signaling is used. This can be either the PABX or a PABX satellite system.  System number of the communication system that is configured for central busy signaling.  Value range: 1 to 255

Parameters	Description
Call no. target system	Call number of the communication system that is configured for central busy signaling. Enter the PABX number and not the station number in this field. The fact that no extension is entered for this PABX number must be taken into account in the LCR dial plan!  Example: If the call number of the destination system is 999 the dial plan entry must be -999 (and not -999XXX and not -999Z).
<b>Connection data - Routing</b>	
Call no. target system	This data defines a communication system where centralized connection data recording takes place. This can be either the PABX or a PABX satellite system.  Call number of the communication system that is set up as a central recording system (see also the note above for Call no. target system).

#### 27.3.10.4 Trunks/Routing > Assign MSN

Parameter Description of Tabs::

- **Display MSN**
- **Edit MSN**

Parameters	Description
MSN	Display or entry of the MSN (point-to-multipoint call number).
Trunk	Displays the assignment of the trunk on which the MSN is active.

#### 27.3.10.5 Trunks/Routing > ISDN Parameters

The reference clock (ISDN clock) synchronizes operations on CO trunks within a specific network or within the Central Office. Normally, the communication system automatically selects the trunk to be used as a reference clock for all of the communication systems within a given network or CO. However, if the reference clock line is missing or malfunctions, then you must configure one or more other trunks as the reference clock line.

The communication system chooses the trunk in the following order:

1. Allowed list
2. S<sub>2M</sub> CO trunk
3. S<sub>0</sub> CO trunk
4. S<sub>2M</sub> tie trunk (only slave configuration)
5. S<sub>0</sub> tie trunk

Parameter Description of Tabs:

- **ISDN Clock**



Parameters	Description
<b>Index</b>	The positions reflect the priorities 1-4 (for the Allowed list) and 1-16 (for the Denied list).
<b>Allowed Lists</b>	If the Allowed list contains entries, the automatic line selection of the communication system is overridden. The ISDN ports (max 4 possible) entered in the Allowed list are used first in the search for the reference clock line.
<b>Denied Lists</b>	The ISDN ports (max 16 possible) entered in the Denied list are skipped in the search for the reference clock line.

## 27.3.11 Classes of Service

The functions for the classes of service for CO trunks are grouped together under **Classes of Service**. They control subscriber access to external calls that may be subject to toll charges.

### 27.3.11.1 Classes of Service > Stations

Parameter Description of the Tab:

- **Show all stations**

Parameters	Description
<b>Call No., Call number</b>	Station number of the subscriber.
<b>Name</b>	Name of the subscriber.
<b>Day</b>	Selected COS group for the Day service.
<b>Night</b>	Selected COS group for the Night service.
<b>Class of Service Group Day</b>	Displays the COS group for the Day service. The selection you make refers to the <b>COS Day</b> table, where the COS group is linked to the actual classes of service.
<b>Class of Service Group Night</b>	Displays the COS group for the Night service. The selection you make refers to the <b>COS Night</b> table, where the COS group is linked to the actual classes of service.

### 27.3.11.2 Classes of Service > Day: Class of Service Groups

Parameter Description of Tabs::

- **Edit Names**
- **Edit COS Group**
- **Day: Display COS Members**

Parameters	Description
<b>Class of Service Group</b>	Freely selected name for COS groups 1 to 15; assignment of CO call privileges per route (trunk) for day and night, respectively When configuring the stations, access to external call numbers can be restricted by assigning class of service groups.
<b>Class of Service</b>	Assignment of classes of service to the individual COS groups for day service. All restrictions are effective only for the lines for a route of the type CO.
<b>Class of Service Group: Internal</b>	The subscriber may only make internal calls. Default value: default in COS group 1
<b>Class of Service Group: Outward-restricted</b>	The subscriber may only answer (not make) external calls. Default value: default in COS group 2
<b>Class of Service Group: Allowed list</b>	The subscriber may only dial the external numbers defined in the Allowed list. Outward-restricted trunk access applies if no call number is entered. Default value: default in COS group 4
<b>Class of Service Group: Denied list</b>	The subscriber is not permitted to dial the external numbers defined in the Denied list. Unrestricted trunk access applies if no call number is entered. Default value: default in COS groups 3, 5, 6
<b>Class of Service Group: Unrestricted</b>	Subscribers can answer and set up incoming and outgoing external calls without restriction. Default value: default in COS groups 7 through 15
<b>Display COS Members</b>	Displays call numbers and names of the members of the selected COS group.

### 27.3.11.3 Classes of Service > Night: Class of Service Groups

Parameter Description of Tabs::

- **Edit Names**
- **Edit COS Group**
- **Night: Display COS Members**

Parameters	Description
<b>Class of Service Group</b>	Freely selected name for COS groups 1 to 15; assignment of CO call privileges per route (trunk) for day and night, respectively When configuring the stations, access to external call numbers can be restricted by assigning class of service groups.
<b>Class of Service</b>	Assignment of classes of service to the individual COS groups for night service. All restrictions are effective only for the lines for a route of the type CO.
<b>Class of Service Group: Internal</b>	The subscriber may only make internal calls. Default value: default in COS group 1
<b>Class of Service Group: Outward-restricted</b>	The subscriber may only answer (not make) external calls. Default value: default in COS group 2

Parameters	Description
<b>Class of Service Group: Allowed list</b>	The subscriber may only dial the external numbers defined in the Allowed list. Outward-restricted trunk access applies if no call number is entered. Default value: default in COS group 4
<b>Class of Service Group: Denied list</b>	The subscriber is not permitted to dial the external numbers defined in the Denied list. Unrestricted trunk access applies if no call number is entered. Default value: default in COS groups 3, 5, 6
<b>Class of Service Group: Unrestricted</b>	Subscribers can answer and set up incoming and outgoing external calls without restriction. Default value: default in COS groups 7 through 15
<b>Display COS Members</b>	Displays call numbers and names of the members of the selected COS group.

#### 27.3.11.4 Classes of Service > Allowed Lists

Parameter Description of Tabs::

- **Display Speed Dials**
- **Add Call Number**

Parameters	Description
<b>List 1-6</b>	Display/Add/Edit/Delete an allowed number. The Allowed list contains the phone numbers that may be called by the subscriber. Up to 6 Allowed lists can be created. Your first Allowed list can have up to one hundred entries, and the remaining five lists can have a maximum of ten entries.
<b>Phone number</b>	Call numbers can contain up to 27 digits, which can include the numbers 0 through 9 and the symbols * and #. The complete telephone number does not need to be listed. To permit users to dial (toll free) 0800xxx numbers, for example, only 0800 needs to be entered here. Since these lists are only for outgoing external calls, it is not necessary to include the trunk seizure code with the numbers you enter.

#### 27.3.11.5 Classes of Service > Denied Lists

Parameter Description of Tabs::

- **Display Speed Dials**
- **Add Call Number**
- **Edit Analysis Filter**

Parameters	Description
<b>List 1-6</b>	Display/Add/Edit/Delete a denied number. The Denied list contains the phone numbers that cannot be called by the subscriber. Up to six Denied lists can be created. The first Denied list can have up to fifty entries, while the remaining five lists can have a maximum of ten entries each.
<b>Phone number</b>	Call numbers can contain up to 27 digits, which can include the numbers 0 through 9 and the symbols * and #. The complete telephone number does not need to be listed. For example, to prohibit users from dialing (toll-based) 0900xxx numbers, you would only need to enter "0900" here. Entering a # sign at the start of a denied number prevents the toll restriction from being bypassed for system telephones when an analog CO line is to be seized using DTMF signaling or when switching to DTMF during the dialing. Since these lists are only for outgoing external calls, it is not necessary to include the CO access code with the numbers you enter.
<b>Edit Analysis Filter</b>	
You can use exception filters for any Denied list to define which digits should not be compared with the corresponding Denied list. The communication system excludes the set range of digits before the digit analysis.	
<b>From digit ... To digit</b>	The analysis filter is active in this numeric range (1-25) within the phone number.
<b>Character</b>	By prohibiting the characters * and #, subscribers are prevented from entering these characters to bypass the toll restriction.

### 27.3.11.6 Classes of Service > Night Service

Parameter Description of the Tab:

- **Edit night service**

Parameters	Description
<b>Authorized station for night service</b>	If you want particular stations to have the ability to switch the communication system to night mode, you must enter these stations to the list of stations in the Authorized Station for Night Service list. A maximum of 5 stations can be entered.  Default value: 100
<b>Station</b>	List of all stations present in the communication system.
<b>Authorized station</b>	List of authorized stations that can enable night mode.
<b>Add &gt;&gt;</b>	Adds the selected station to the authorized stations list

### 27.3.11.7 Classes of Service > CON Group Assignment

Parameter Description of Tabs::

- **Edit Group Assignment**
- **Trunk to Group**
- **Group Speed Dial Range**

Parameters	Description
<b>CON Group Assignment</b>	Assignment of a CON group (1-64) to a subscriber. You can assign a CON group to individual stations in the communication system via the CON Group Assignment. When coding the connection matrix, you can then access these stations and define which stations can reach which other stations. All stations are assigned to CON group 1 by default. This provides all stations with unrestricted access to all other stations.  Value range: 1 - 64
<b>Trunk to Group</b>	Assignment of a trunk to the CON group. You can assign a CON group to individual lines in the communication system via the CON Group Assignment. When coding the connection matrix, you can then access these groups and define which subscribers can access which lines. All CO trunks are assigned to CON group 1 by default. All stations thus have unrestricted access to all trunks (both inbound and outbound).  Value range: 1 - 64
<b>Group Speed Dial Range</b>	Every CON group is assigned a range of speed dials (SSD). If a user selects a speed dialing system number, the system determines whether or not this user is authorized to select that speed dialing system number by determining the associated ITR group. The number is dialed if this speed dialing system number belongs to the range of speed dialing system numbers assigned to the relevant CON group. An error message is issued if the speed dialing system number does not belong to the assigned group. The speed-dial number ranges can overlap in the CON group. Individual speed dialing system numbers may not be entered in the ITR groups and multiple speed dialing system number groups may not be entered in an ITR group. For example, the following are allowed: CON 1: 0-99; CON 2: 50-150; CON 3: 200-500. And the following are not allowed: CON 1: 0, 5, 10; CON 2: 50-100, 300-500.  Value range: 0-7999

### 27.3.11.8 Classes of Service > CON Matrix

Parameter Description of Tabs::

- **Edit the CON Matrix**

Parameters	Description
<b>CON matrix</b>	If you want to selectively edit one connection method between two CON groups, click in the field at the intersection point of these CON groups in the CON matrix. Click repeatedly in the field to release or block the connection methods in one direction, the other direction, or both directions. To use the connection matrix, you must first assign each station to a group via Group assignment. By default all stations and all trunks are in Group 1. Since Group 1 is coded with unlimited access, by default, every station has access to every other station and to all trunks.
<b>Grid</b>	Note that the matrix shows one list of groups vertically across the top and another list of groups horizontally down the left-hand side. At each conjunction there is a box. The type of arrow in this box indicates the relationship of the two groups to one another. An empty field means that no connection is possible. A connection matrix with no arrows results in a totally disabled communication system.

Parameters	Description
<b>Block all</b>	The CON matrix suppresses traffic between stations and trunks within the same group (subsystem) and between groups.
<b>Release all</b>	The CON matrix allows traffic between stations and trunks within the same group (subsystem) and between groups.
<b>Group-internal only</b>	The CON matrix allows traffic only between stations and trunks within the same group (subsystem).

### 27.3.11.9 Classes of Service > Autom. night service

Parameter Description of Tabs::

- **Display all days**
- **Edit day**

Parameters	Description
<b>Monday, Tuesday, Wednesday, Thursday, Friday, Saturday, Sunday, Special Day</b>	which is configured via the schedule. The schedule covers the entire week (Monday through Sunday) as well as special days. Special days are holidays or special days such as company holidays.
<b>Zone</b>	The schedule for a day can be split into up to 4 zones (time intervals). These zones can be defined sequentially and without gaps, i.e., the end time of the first interval may be identical to the start time of the second interval, for example. However, an interval cannot have the same start and end times. The minimum length of an interval is 15 minutes.  Value range: 1-4
<b>Start</b>	Start time for the zone. If the first interval for a day begins at 0.00 hours, then the start time must be entered as 00:00.
<b>End</b>	End time for the zone. If the last interval for a day ends at 24.00 hours (12 p.m.), the end time must be entered as 23:59 (11:59).
<b>Night call no.</b>	Night phone number for the zone. If no call number is entered for the night call number, night service per line is activated in the system. The destinations for this are set under Lines/networking > change line> Ringing assignment per line. The timers entered via the automatic night service apply for all trunks.
<b>OK</b>	The zone will be created.
<b>Delete</b>	The defined zone will be deleted.

### 27.3.11.10 Classes of Service > Special Days

Parameter Description of the Tab:

- **Edit Special Days**

Parameters	Description
<b>Day</b>	When you select a date in the calendar, this is automatically entered here.
<b>Name</b>	Name for this special day (e.g., Whit Monday)

## 27.3.12 Auxiliary Equipment

The functions for auxiliary equipment such as Music on Hold (MoH) or for connecting an entrance telephone/door opener at the system ports (trunks) are grouped together under **Auxiliary Equipment**.

### 27.3.12.1 Auxiliary Equipment > Announcements/Music On Hold > Announcements and Music on Hold

Parameter Description of Tabs:

- **Edit Announcements**

Parameters	Description
<b>Type of ann.</b>	Type of announcement parameter allows you to choose among three possible options. The music for this feature can be supplied internally or externally.
<b>Type of ann.: None</b>	Select this option for no playback.
<b>Type of ann.: Start / Stop</b>	Select this option for a single playback.
<b>Type of ann.: Continuous</b>	Select this option for continuous playback. This option is not supported in embedded systems.

Parameter Description of Tabs:

- **Edit Music on Hold**

Parameters	Description
<b>Type of MOH</b>	Type of MOH parameter allows you to choose among three possible options. The music for this feature can be supplied internally or externally.

Parameters	Description
<b>Type of MOH: No Music On Hold</b>	If this option is selected, the Music on Hold feature will be deactivated completely. This does not apply when an external call is transferred by a transfer before answer; the caller then hears the ring tone.
<b>Type of MOH: MOH without ringing tone</b>	If this option is selected, in the case of an unmasked transfer, the caller will hear Music on Hold while the transfer takes place, as well as while the call is being transferred by the transferring party and the external connection is ringing at the transferred destination.
<b>Type of MOH: MOH with ringing tone</b>	<p>If this option is selected, in the case of an unmasked transfer, the caller will hear Music on Hold while the transfer takes place. As soon as the call is transferred through by the transferring party and the external connection is ringing at the transferred destination, the caller will hear a ring tone.</p> <p>The MOH with ringing tone option should always be set in a network system in order to provide the customer with a uniform environment.</p> <p>If the caller is reaching the system through Internet Telephony Service Provider(ITSP), this option will not apply and the caller will hear Music On Hold during transfer.</p>

Access and Type activation via Manager E.

The input format for Music On Hold is a wave file with PCM and 16 bits. Supported sample rates are 8, 22.05, 24, 32, 40, 44.1 and 48 kHz in mono or stereo. The preferred format is PCM, 16 bits, 8kHz, mono. The recommendation is to use the preferred input format and limit the length of the wave files to about 2 min. NEW: One MOH per day and one per night! Reset required!

### 27.3.12.2 Auxiliary Equipment > Entrance Telephone (Door Opener)

Parameter Description of Tabs:

- **Edit Door Opener**

Parameters	Description
<b>Station</b>	Selection of the phone number / connection port of the entrance telephone. The Station port type must be P.O.T or No Port.
<b>Destination</b>	Selection of the phone number / connection port of the entrance telephone ring destination. A station number or a group number can be specified as the ring destination at which a special ring is signaled when the doorbell button is pressed. The call is signaled in accordance with the call forwarding algorithms defined in "Settings - Incoming calls".
<b>Door opener</b>	Activates the door opener function. By setting this flag, a door opener connected at the TFE-S can be activated for the stations.
<b>DTMF</b>	Setting this flag enables the door opener to be activated remotely with a DTMF transmitter.
<b>FWD</b>	Setting this flag enables external forwarding of the entrance telephone ring destination.



### 27.3.12.3 Auxiliary Equipment > SmartVM

Parameter Description of Tabs:

- **Edit SmartVM Mailboxes**

Parameters	Description
<b>Mailbox call no.</b>	Input of the mailbox call numbers. A mailbox is identified by means of the mailbox call number. If a mailbox is to be assigned to a station, the mailbox must have the same call number as the station.
<b>Name</b>	Displays the mailbox name. The name corresponds to the name of the subscriber (if available). In the case of a group, the group name is displayed.
<b>Greeting</b>	Selects the greeting. The usability of the items offered will depend on the selected phone menu (TUI). With the OSO TUI, only Greeting 1 is supported for standard mailboxes.
<b>Greeting: Greeting 1-4</b>	The selection of Greetings 1-4 depends on the type of the mailbox: Standard mailbox: Greeting 1 or 2 (only Greeting 1 with OSO TUI) Attendant mailbox: Greeting 1, 2, 3 or 4
<b>Greeting: Day/Night</b>	The greeting depends on the Day/Night mode: Day - Greeting 1 / Night - Greeting 2
<b>Greeting: Type of Call</b>	Only for standard mailbox: Greeting depends on the status of the subscriber: Call not accepted - Greeting 1 / Busy - Greeting 2
<b>Greeting: None</b>	No greeting is played. However, the mailbox remains active, e.g., to forward the call to the intercept position.
<b>Recording</b>	If this flag is enabled, the mailbox is a standard mailbox. It can then no longer be an Attendant mailbox. If the flag is disabled (default), the mailbox does not have the option of recording a message. The subscriber can activate the recording when checking his or her voicemail box for the first time. This ensures that no messages can be recorded before the mailbox has been activated by the user. Default: enabled
<b>AutoAttendant</b>	If this flag is enabled, the mailbox is an Attendant mailbox (AutoAttendant). It can then no longer be a standard mailbox. A maximum of 100 mailboxes can be configured as Attendant mailboxes. When a standard mailbox is converted to an Attendant mailbox, all existing messages of the mailbox are deleted. Default: disabled
<b>Password Reset</b>	If this flag is enabled, the password of the mailbox is reset to 123456. The subscriber must change the password at the next access to his or her mailbox. Default: disabled

Parameter Description of Tabs:

- **Edit SmartVM Parameters**

Parameters	Description
<b>General parameters</b>	
<b>Max. mailbox no. length</b>	Maximum length of voicemail box call number. Value range: 2 - 16 positions; default value: 3 positions
<b>Max. message length (min)</b>	Maximum length of the recording time for a message. Range of values: 1 or 2 minutes; default value: 2 minutes
<b>Call number length delimitation</b>	For outgoing connections that are initiated by the SmartVM (AutoAttendant suffix dialing and AutoAttendant speed dialing), only call numbers up to the specified length can be dialed. In cases where longer call numbers have been configured, no connection is established. By default, the call number length restriction corresponds to the (internal) call number length of the mailbox, so only internal dialing is allowed.  Value range: 2 to 30, default value: 3
<b>General fax intercept</b>	Entry of the fax intercept destination to which the SmartVM should normally send incoming faxes. If no fax intercept destination is specified, incoming faxes will be rejected.  Value range: max. 16 digits
<b>Standard lang.</b>	Selects the language of the user prompts. Applies to all mailboxes. If user prompts in the desired language are not available, the language is set to UK English (enuk).
<b>Telephone User Interface</b>	Selects the phone menu structure of the voicemail box (Telephone User Interface, TUI). The selection applies to all voicemail boxes.
<b>Telephone User Interface (TUI): SmartVM</b>	SmartVM TUI, similar to the Xpressions Compact / EVM TUI (default).
<b>Telephone User Interface (TUI): OSO</b>	OSO TUI, similar to the UC Suite TUI.
<b>Order of Date Announcement</b>	Only visible with SmartVM TUI:  Setting of the announcement sequence for message, recording date and number of the caller (if known).
<b>Order of Date Announcement: Date After Message</b>	Only visible with SmartVM TUI:  Message - Recording date - Number of the caller (if known).
<b>Order of Date Announcement: Date Before Message</b>	Only visible with SmartVM TUI:  Recording Date - Number of the Caller (if known) - Message.  The following applies to messages from internal subscribers:  Name of the internal subscriber (if available) -- Recording date -- Number of the caller (if known) -- Message.
<b>Amount of Messages per Mailbox</b>	Maximum number of messages for a mailbox. Value range: 0 to 100, default value: 30
<b>EVM Deactivation</b>	If this flag is enabled, the SmartVM is disabled.  Default: disabled

Parameters	Description
<b>Allow callback from VM to know number only</b>	<p>When external UserA calls UserB, UserB has call forward to his voice mail, external UserA leaves a voice message, UserB call the SmartVM, enter his password and while listens to the message dials the digit '8'. By dialing this number there is a callback to UserB.</p> <p>If this flag is enabled callback occurs if the the number of userB belongs to the known numbers. Known numbers are the Mobile phone number and the Home/external phone number of the profile details of User Management(Applications-UC Smart-User Management)</p> <p>Default: enabled</p>
<b>AA VP Behavior</b>	
Setting for whether the AutoAttendant should automatically play announcements for certain cases.	
<b>VP Before Transfer</b>	<p>If this flag is enabled, the following announcement is played for "VP Before Transfer":</p> <p>"Please wait, you are being connected..."</p> <p>Default: disabled</p>
<b>VP Transfer Result</b>	<p>If this flag is enabled, one of the following prompts is played for "VP Transfer Result":</p> <p>"The station number does not exist."</p> <p>"The station is busy."</p> <p>"The station is not responding."</p> <p>Default: enabled</p>
<b>VP Intercept</b>	<p>If this flag is enabled, one of the following announcements is played for "VP Intercept":</p> <p>"You are being connected with the operator. Please wait."</p> <p>"You are being connected with the mailbox of the subscriber."</p> <p>"Please wait, you are being connected..."</p> <p>Default: enabled</p>
<b>VP Before Release</b>	<p>If this flag is enabled, one of the following prompts is played for "VP Before Release":</p> <p>"Please call later."</p> <p>"Thank you. Goodbye."</p> <p>"The mailbox number is not valid."</p> <p>Default: enabled</p>

Parameter Description of Tabs:

- **Edit Automatic Attendant Parameters**

Parameters	Description
<b>Call number</b>	Call number of the AutoAttendant (default: 352).
<b>Intercept after announcem.</b>	If this flag is enabled, the call is intercepted to the intercept position (e.g., the attendant console) after the greeting. No speed-dialing destination can be dialed during the announcement of the greeting.  Default: disabled
<b>no suffix-dialing</b>	If this flag is activated, the caller can only be redirected to other destinations by the dialing of speed-dial destinations. The caller cannot dial any multi-digit call number.  Default: disabled

Parameter Description of Tabs:

- **Edit Speed Dial/Intercept Dest. Day**
- **Edit Speed Dial/Intercept Dest. Night**
- **Edit Speed Dial/Intercept Dest. 3**
- **Edit Speed Dial/Intercept Dest. 4**

Parameters	Description
<b>Select</b>	Selection of an internal subscriber (1st. half of the list) or a voicemail box (2nd. half of the list) as a speed dial destination or intercept position.
<b>Action</b>	Displays the 10 possible speed dial destinations and the intercept position.
<b>Call number</b>	Call number of the selected subscriber or the selected voicemail box.
<b>Name</b>	Name of the selected subscriber or the selected voicemail box.
<b>Type</b>	Selects the type of the call number.
<b>Type: Call number</b>	In this case, the selected subscriber is called with the assigned speed dial number.
<b>Type: Mailbox</b>	In this case, the selected voicemail box is called with the assigned speed dial number.

## 27.3.13 Payload

The functions for displaying and configuring port types and protocols are grouped together under **Payload**.

### 27.3.13.1 Payload > Devices

Parameter Description of Tabs::

- **Display Global Device Settings**
- **Reset Device Settings to Factory Settings**

Parameters	Description
<b>Global Gateway of Type G.711</b>	Devices is the collective name for stations, features, and functions that require channels. The information displayed includes the codec type of the global gateway, the maximum number of licensed B channels available, and the maximum number of LAN clients on a channel for music on hold (calls above this number are not put through).
<b>Max. No. of B Channels Supported by Hardware</b>	
<b>No. of LAN Clients per MoH Channel</b>	

Resetting the device settings requires a restart of the communication system.

### 27.3.13.2 Payload > Media Stream Control (MSC)

Parameter Description of Tabs::

- **Edit MSC Jitter Parameters**

Parameters	Description
	The Media Stream Control (MSC) monitors and administers the media streams that are routed via the communication system. It provides for the transfer of media data between networks via gateways(TDM/IP).
<b>Traffic Statistics (SNMP Only)</b>	Required for access to the data of the per-call statistics of the system via SNMP.
<b>RTCP Packet Generation Interval (sec)</b>	Report interval in seconds for RTCP packets (Real-time Transport Control Protocol). This interval is used for the negotiation and compliance of Quality of Service (QoS) parameters through the periodic exchange of control messages between senders and receivers.  Value range: 5 to 10, default value: 5

Parameter Description of Tabs::

- **Reset MSC Settings to Factory Defaults**

Parameters	Description
<b>Reset MSC Settings to Factory Defaults</b>	Restore all original settings of the MSC.

### 27.3.13.3 Payload > HW Modules

Manage the DSP modules of the communication system

Parameter Description of Tabs:

- **Display All HW Modules**
- **Edit DSP Settings**
- **Edit DSP Jitter Settings**

Parameters	Description
<b>HW Type</b>	Displays the DSPs (Digital Signal Processors) used in the communication system. Possible options are: <ul style="list-style-type: none"> <li>• <b>Onboard</b> = Integrated DSP of the mainboard</li> <li>• <b>OCCB X-1</b> = DSP of an OCCB subboard (OCCB1 or OCCB3)</li> </ul>
<b>Firmware version</b>	Current firmware version of each individual DSP
<b>API Version</b>	Current API (Application Programming Interface) version of each individual DSP
<b>General</b>	
<b>IP Address</b>	IP address of the DSP module (can be changed if the IP address is already used)
<b>Port</b>	Port number of the DSP module
<b>Status display</b>	Used to detect the availability of DSPs Default value: Status messages
<b>Echo Cancellor</b>	Enabling this flag suppresses the echo effect in voice transmissions. Default value: Enabled
<b>DTMF Outband Signaling</b>	When this flag is activated, DTMF signals are transmitted in a separate signaling channel (outband transmission). Default value: Disabled
<b>Fax Parameter</b>	
<b>Error Correction Mode</b>	When this flag is activated, error correction is performed during transmission (Error Correction Mode in the T.30 protocol). The fax devices used must support this mode also. Default value: Enabled
<b>Number of Redundancy Packets</b>	Defines the number of redundancy packets: the higher the value, the lower the risk of packet loss during fax transmission. Higher values, however, also require a higher bandwidth. Default value: 2
<b>Maximum Network Jitter (hex msec)</b>	Defines the maximum network jitter in milliseconds: the higher the value, the greater the possible round-trip delay of data packets in networks. Only hexadecimal values consisting of the digits 0 to 9 and A to F are allowed. Avoid making any changes to this parameter. Default value: 00C8
<b>Fax/Modem Tone Detection Timeout (s)</b>	Defines the time in seconds for the detection of fax tones during calls: this ensures that the T.38 fax protocol is used. After the preset time has elapsed, no more fax tones are detected. A value of 0 means that fax tone detection is enabled for the entire duration of the connection. Default value: 0
<b>DSP Jitter</b>	
<b>Jitter Buffer Type</b>	Definition of the Jitter buffer type Default value: Adaptive
<b>Jitter Buffer Type: Static</b>	The average delay of the jitter buffer always remains the same.

Parameters	Description
<b>Jitter Buffer Type: Adaptive</b>	The jitter buffer aligns with the average delay when receiving data. It attempts to keep the delay as low as possible while keeping data packet loss to a minimum.
<b>Average Delay for Voice (ms)</b>	<p>Defines the time in milliseconds during which an IP packet should be held in the jitter buffer in the case of IP-based voice transmission.</p> <p><b>INFO:</b> In the case of the <b>Jitter Buffer Type Adaptive</b>, the value defined here is only a start value.</p> <p>Default value: 40</p>
<b>Maximum Delay for Voice (ms)</b>	<p>Defines the maximum delay for voice in milliseconds</p> <p><b>Jitter Buffer Type Static:</b> Enter the maximum number of milliseconds permitted for a delay before the jitter buffer intervenes in the data stream when receiving IP packets as part of a voice transmission. The recommended value for the static jitter buffer is 80 for most environments.</p> <p><b>Jitter Buffer Type Adaptive:</b> Enter the maximum number of milliseconds for the average delay for voice. Outgoing packets are lost if the actual delay measured is greater. The recommended value for the adaptive jitter buffer is 120 for most environments.</p> <p><b>Note:</b> This value must always be greater than the value specified in the "Average Delay for Voice (ms)" field.</p> <p>Default value: 120</p>
<b>Minimum Delay for Voice (ms)</b>	<p>Defines the minimum delay for voice in milliseconds</p> <p><b>Jitter Buffer Type Adaptive:</b> Enter the minimum number of milliseconds permitted for the average delay for voice. The average delay is always greater than or equal to this value.</p> <p>Default value: 20</p>
<b>Packet Loss / Delay Preference</b>	<p>Defines the ratio between packet loss and propagation delays for data packets</p> <p><b>Jitter Buffer Type Adaptive:</b> Specify a value between 0 and 8 depending on what seems more acceptable in the event of large propagation delays - loss of packets or even greater delays. A value of 0 means minimal packet loss and greater propagation delays. A value of 8 means minimal propagation delays and a higher risk of packet loss. The recommended value for most environments is 4.</p> <p>Default value: 4</p>
<b>Average Delay for Data (msec)</b>	<p>Defines the average delay for data in milliseconds</p> <p>Enter the average number of milliseconds a data packet should be held in the jitter buffer for data transmissions. The recommended value for most environments is 60.</p> <p>Default value: 60</p>
<b>Maximum Delay for Data (msec)</b>	<p>Defines the maximum delay for data in milliseconds</p> <p>Enter the maximum number of milliseconds permitted for a delay before the jitter buffer intervenes when receiving IP packets as part of a data transmission. The recommended value for most environments is 200.</p> <p><b>INFO:</b> Higher values (from about 2000) have no effect. As soon as a packet has entered the buffer, it will leave the buffer again. Although values under 100 msec are possible, they are not recommended in practice.</p> <p>Default value: 200</p>

## 27.3.14 Statistics

The functions for displaying statistics are grouped together under **Statistics**.

### 27.3.14.1 Statistics > Gateway Statics > Mainboard > Device Statistics

Parameter Description of Tabs::

- **Display SCN Statistics**
- **Display LAN Statistics**

Parameters	Description
<b>Device Type</b>	Displays the existing LAN and SCN (Switched Circuit Network) components.
<b>No. of Currently Used Resources</b>	Displays the currently allocated resources of a component (configured and used channels).
<b>Total</b>	Displays the sum of the currently allocated resources.
<b>auto refresh</b>	The display is automatically updated every 60 seconds.
<b>Seconds until next automatic refresh</b>	Displays a countdown timer, starting at 60 seconds.

### 27.3.14.2 Statistics > Gateway Statistics > Mainboard > MSC Statistics

Parameter Description of Tabs::

- **Display Overall Statistics**  
MSC statistics are statistics of the media stream, which is implemented on digital signal processors between IP and TDM (Media Stream Control). The MSC overall statistics offer an overview of the statistical data for all registered calls. It provides information on the sent and unsent RTP/TCP packets, the packets received and not received, and the number of bytes sent and received.

Parameter Description of Tabs::

- **Display Per-Call Statistics**  
The MSC Per-Call Statistics show the connection data and parameters used for each connection involving conversions using digital signal processors in tabular form. It is used for error analysis by experts.

### 27.3.14.3 Statistics > SNMP Statistics

Parameter Description of Tabs:

- **Display Statistics Table**
- **Display Statistics**



Parameters	Description
<b>ifTable Statistics</b>	SNMP statistics for individual interfaces (if = interface) of the communication system (e.g., Ethernet interfaces).
<b>IP Statistics</b>	Details and errors associated with IP routing
<b>TCP Statistics</b>	Details and errors associated with the TCP protocol
<b>UDP Statistics</b>	Details and errors associated with the UDP protocol

#### 27.3.14.4 Statistics > Telephony Statistics > System Texts

Parameter Description of Tabs:

- **Display System Texts**

Parameters	Description
<b>Available languages</b>	Displays the telephone user interface languages available in the communication system

#### 27.3.14.5 Statistics > Telephony Statistics > UCD Agents

Parameter Description of Tabs:

- **Display UCD Agents**

Parameters	Description
<b>Count UCD agents</b>	
<b>Total</b>	Total number of UCD agents logged into the communication system
<b>Available</b>	Number of available UCD agents
<b>UCD agent state</b>	
<b>Phone number</b>	Call number of the UCD agent
<b>Name</b>	Name of the UCD agent
<b>ID</b>	ID of the UCD agent
<b>UCD group</b>	UCD group to which the UCD agent is assigned.
<b>Status</b>	Status of the UCD agent

#### 27.3.14.6 Statistics > Telephony Statistics > Trunk Status

Parameter Description of Tabs:

- **Display Trunk Status**

Parameters	Description
<b>Date</b>	Date of status query or date of last status change for trunk
<b>Time</b>	Time of status query or time of last status change for trunk
<b>Slot/Port</b>	Displays the board, the slot and the interface (port) or the LAN Interface
<b>Trunk Number</b>	Trunk code
<b>Comment</b>	Trunk status (the most recent status of the trunk is displayed.) Possible line statuses: <ul style="list-style-type: none"> <li>• <b>Idle</b> (line idle)</li> <li>• <b>Alerting</b> (call is pending)</li> <li>• <b>Connected to:</b> (connected to the displayed phone number)</li> <li>• <b>Line shutdown</b></li> <li>• <b>Line failure</b></li> </ul>

### 27.3.14.7 Statistics > Telephony Statistics > Forwarding

Parameter Description of Tabs:

- **Display Forwarding**

Parameters	Description
<b>Call forwarding</b>	
<b>Status</b>	Status of call forwarding: <ul style="list-style-type: none"> <li>• <b>Off</b> (no call forwarding rules active)</li> <li>• When call forwarding has been enabled, the call forwarding type and destination are displayed.</li> </ul>
<b>Forwarding destination from</b>	Indicates whether the called party is the forwarding destination of a call forwarded by another subscriber. The call number and name of the forwarding subscriber are displayed.
<b>Ringling group on</b>	
<b>Stations included</b>	The number and name of the stations included in the ringing group
<b>Connection of</b>	Indicates whether the station is the ringing group destination of another station. The call number and name of the primary station are displayed.

### 27.3.14.8 Statistics > Telephony Statistics > Stations

Parameter Description of Tabs:

- **Display Station Parameters**
- **Display Activated Features**

Parameters	Description
<b>Phone number</b>	Station number
<b>Name</b>	Name of the station
<b>Direct inward dialing</b>	DID number of the station
<b>Device type</b>	Type of phone (e.g., OpenStage 60)
<b>Clip/Lin</b>	Location Identification Number LIN  For U.S. and Canada only: the enhanced E911 emergency service transmits geographical information on the caller in addition to the phone number when an emergency call is dispatched. Every station number with a valid DID number must be assigned a LIN.
<b>Access</b>	For analog and U <sub>P0/E</sub> phones: the board, the slot and the port number are displayed. Additional information which is only displayed for U <sub>P0/E</sub> phones: master or slave.  For IP phones: the LAN interface, the type and the number are displayed
<b>Parameters</b>	
<b>Extension Type</b>	Station type, such as Standard or Fax  Default value: Standard
<b>Language</b>	Language setting of the telephone
<b>Call signaling internal</b>	Call type for the signaling of internal calls  Default value: Ring type 1
<b>Call signaling external</b>	Call type for the signaling of external calls  Default value: Ring type 1
<b>Class of Service (LCR)</b>	Class of Service for Least Cost Routing (LCR)  Default value: 15
<b>Licence Type</b>	License type of the station
<b>Features</b>	
<b>Do Not Disturb</b>	Status of the Do not Disturb feature  Default value: off
<b>Answer text</b>	Status of the Answer text feature  Default value: off
<b>Lock code</b>	Status of the Lock code feature  Default value: off
<b>Suppress calling ID</b>	Status of the Suppress calling ID feature  Default value: off
<b>Ringling group on</b>	Status of the Ringling group on feature  Default value: off
<b>Disable incoming ringing</b>	Status of the Ringer cutoff feature  Default value: off

Parameters	Description
<b>Out of Hunt group/Group ringing</b>	Status of the Group Call/Hunt Group feature Default value: off
<b>Call waiting tone</b>	Status of the Silent camp-on (call waiting tone) feature Default value: off
<b>Direct answering</b>	Status of the Direct answering feature Default value: off
<b>Call waiting terminating</b>	Status of the Call waiting terminating feature Default value: off
<b>Call forwarding after timeout</b>	Status of the Call forwarding after timeout feature Default value: off
<b>FWD</b>	Status of the Call Forwarding (CF) feature Default value: off

## 27.4 Applications

Functions for configuring the Application Server for Unified Communications and Web Services are grouped together under **Applications**.

### 27.4.1 Application Selection

The functions for selecting the Unified Communications solution are grouped under **Application Selection**.

#### 27.4.1.1 Application Selection

Parameter Description of Tabs:

- **Application Selection**

Parameters	Description
<b>Select application packages</b>	Choice of application packages with UC Smart or with UC Suite. For the application package with UC Suite on the OpenScape Business UC Booster Server, the IP address of the UC Booster Server (IP address of the Linux server) is also required.
<b>Application Selection</b>	Display of the supported components, depending on the selected application package, including the IP address of the server used.

## 27.4.2 UC Smart

The relevant functions for unified communications are grouped under **UC Smart**.

### 27.4.2.1 UC Smart > Basic Settings

Parameter Description of Tabs:

- **Basic Settings**

Parameters	Description
<b>Security</b>	
<b>Enable / Disable UC Smart</b>	
<b>Active</b>	UC Smart and UC Suite cannot be active simultaneously. (Additional parameters appear after activation)
<b>Access Rules</b>	
<b>HTTP</b>	UC Smart clients basically access the system with encryption using HTTPS (recommended) or without encryption using HTTP (not recommended). The selection is made in the application itself. The authorization for one or both of these protocols is granted here.
<b>HTTPS</b>	
<b>Password Policy</b>	
<b>Force user to choose secure password</b>	Password policy for UC Smart clients. The default password must be changed at the first login, and the new password must comply with policy selected here (see question mark button). The password is stored in the client; otherwise, it is requested whenever the client is started.
<b>Save login data for devices</b>	The login data is additionally stored in the phone.
<b>System-wide initial UC Smart password</b>	A system-wide initial password affects all configured UC Smart users who have never logged into UC Smart or who have not changed their initial password. Each affected user must then assign a custom password.  <b>INFO:</b> The initial assignment of a system-wide UC Smart password presents a security risk, especially if the individual users do not promptly assign a personal password. Alternatively, the assignment of individual initial passwords for each user is recommended.

### 27.4.2.2 UC Smart > User Management

Parameter Description of Tabs:

- **User Management**

Parameters	Description
<b>User</b>	List of all existing users; the selected user must obtain a UC Smart license
<b>Settings</b>	
<b>Users</b>	Displays the internal phone number of the user.

Parameters	Description
<b>Name</b>	Displays the name of the user.
<b>Password</b>	The password of the user of the UC Smart client can be set here.
<b>Language</b>	Language of UC Smart Assistant
<b>The user must assign a new password</b>	(display only)
<b>UC Smart Assistant access</b>	Authorization for access to UC Smart Assistant by the user
<b>Configured as Mobility stations</b>	(display only)
<b>Voicemail licence</b>	(display only)
<b>Associated Services</b>	(display only)
<b>Profile details</b>	
<b>Mobile phone number</b>	Mobile phone number of the subscriber in canonical format (e.g., + 49 173 1234567).
<b>Private/External phone number</b>	Additional phone number of the subscriber in canonical format (e.g., + 49 89 987654321).
<b>E-mail Address</b>	E-mail address of the subscriber.
<b>Voicemail to e-mail</b>	Enable/disable the e-mail notification when a new voice message is received.
<b>Presence visibility</b>	Setting that determines whether the presence status is visible to both internal and external subscribers or just to internal subscribers or not visible to any subscribers.
<b>Licence information</b>	Display of licenses available in the system for each application

### 27.4.2.3 UC Smart: > Status

Parameter Description of Tabs:

- **Status**

Parameters	Description
<b>Application Server</b>	Displays the status of the integrated UC Smart application server
<b>Active Sessions:</b>	Displays the number of active connections per UC Smart client.

### 27.4.3 OpenScape Business, UC Suite

Under **OpenScape Business UC Suite** you will find a group of unified communications functions such as conferencing, departments and groups, configuring the external directory, holiday and other schedules, the Contact Center and the server settings for the UC Suite.

### 27.4.3.1 OpenScope Business, UC Suite

Parameters	Description
<b>OpenScope Business UC Suite</b>	Configuration of the UC Suite, including the myPortal, myAgent, myAttendant and myReports clients, voice and fax messages and conferencing.

### 27.4.3.2 OpenScope Business, UC Suite > User Directory

Parameters	Description
<b>Symbol for presence status</b>	The administrator can change the presence status for every user. A grey figure is currently not logged into the UC Suite.
<b>Edit</b>	Edit settings of the selected UC Suite user
<b>Reset User</b>	Reset the settings of a user to default values. All the user's voicemail messages, personal greetings for the voicemail box, journal entries, scheduled conferences, e-mails and faxes are deleted in the process.
<b>Unlock User</b>	Users who have been locked (e.g., after multiple incorrect password entries) can be unlocked here; displayed through the lock symbol. The administrator can be notified about the lock by the system via e-mail.
<b>Personal details</b>	Personal data of the user
<b>Personal Details: My Personal Details</b>	Own Name, User Name, Password, E-mail Address, Department, Additional Phone No. (in canonical format, e.g., +49 89 700798765), XMPP ID. The password is valid for UC Suite clients.
<b>Personal Details: My Picture</b>	Is automatically scaled
<b>Personal Details: User Level</b>	Can be set only by the administrator for contact centers: if the agent is to be permanently available, select the <b>Permanently available agent</b> check box. The agent will then remain available for calls, faxes and e-mails even when he or she does not accept a call, fax or e-mail. When a user is configured as an agent, the rights of the agent are defined by selecting the appropriate class of service for that agent (i.e., the authorization level as an Agent, Supervisor or Administrator). An agent with the authorization level of a Supervisor or Administrator has elevated privileges.
<b>My Preferences</b>	User-specific settings of the client
<b>My Preferences: Presentation</b>	Skin colors of the user interface; language of the user interface
<b>My Preferences: Notifications</b>	Settings for screen pops
<b>My Preferences: Outlook Connectivity</b>	Generate Calendar Appointments: automatically transfer presence status into Outlook calendar; Calendar Integration: control of presence status through Outlook/iCal appointments (the first keyword in the subject line controls the presence)
<b>My Preferences: Hot Keys</b>	Define hotkeys for call functions
<b>My Preferences: Miscellaneous</b>	Auto-reset presence status to "Office" after end of appointment, enable recording of client logs, define method of transfer, retention period for journal entries (maximum value is 30 days), programming function keys of the phone
<b>Call Rules</b>	Rules for incoming calls

Parameters	Description
<b>Call Rules: Forwarding Destinations</b>	Define forwarding destinations for each presence status (status-based call forwarding)
<b>Call Rules: Rules Engine</b>	Define complex call rules, based on the presence status (rule-based call forwarding)
<b>Communications</b>	Handling of user-specific messages
<b>Communications: VoiceMail Settings</b>	Option of recording of voice messages in each presence status; setting the voicemail language  Default value: disabled
<b>Communications: VM Notification</b>	Notification service for new voicemail - see My Personal Details e-mail address. Prerequisite: the mail server and own e-mail address is configured under Service Center > E-mail Forwarding. "Outbound" generates a user outcall to the specified phone number (in canonical format). For the SMS phone number, see My Personal Details. For SMS templates, see the section in Templates.
<b>Communications: Fax Notification</b>	Notification service for new fax messages - see My Personal Details e-mail address. Prerequisite: the mail server and own e-mail address is configured under Service Center > E-mail Forwarding. "Outbound" generates a user outcall to the specified phone number (in canonical format). For the SMS phone number, see My Personal Details. For SMS templates, see the section in Templates.
<b>Profiles</b>	Profile for personal AutoAttendant
<b>Profiles: Busy, No answer, Meeting, Sick, Break, Out of Office, Vacation, Lunch, At Home</b>	A caller can be redirected to a forwarding destination by post-dialing digit from 0 through 9 (suffix dialing) or can leave a message. As a prerequisite, an announcement is required for each presence status.
<b>Profiles: Skip Dynamic Greeting</b>	The automatic announcement of the presence status is skipped; instead, a caller hears only the announcement of the name and then the Personal AutoAttendant
<b>Sensitivity</b>	Settings to preserve the confidentiality
<b>Sensitivity: Security and Access</b>	Release of voicemails for myAttendant; checking the voicemail box from the own phone without a password
<b>Sensitivity: Presence Visibility</b>	Set the visibility of the own presence status for internal users
<b>Sensitivity: VoiceMail Presence</b>	Announcement of your presence status to external callers. Input of internal phone numbers to be blocked, with the optional use of wildcards.
<b>myAttendant</b>	Display only for subscribers who are licensed for myAttendant
<b>myAttendant: LAN Messages</b>	Text modules for instant messages from myAttendant, free input, selection in the chat window of the client
<b>myAttendant: DIDs</b>	Input of DID numbers; if myAttendant is to be used for multiple companies, a "For" window can be displayed
<b>myAttendant: Communications</b>	Input of an internal number for call forwarding in an emergency or on non-acceptance by myAttendant (for the U.S.)

### 27.4.3.3 OpenScape Business, UC Suite > Departments

Parameter Description of Tabs:

- **Departments**



Parameters	Description
<b>Department Name</b>	Departments classify subscribers in the internal directory into groups based on their organizational affiliation. This enables the an automatic assignment of users to departments in myAttendant, for example.
<b>Group number</b>	(internal numbering with no further significance)

### 27.4.3.4 OpenScape Business, UC Suite > Groups

A voicemail group enables a specific group of subscribers to access voicemails. When a call is placed to the call number of a voicemail group, the call is sent directly to the voicemail (i.e., the voicemail box) of the group and not to the group members.

A fax group (fax box group) enables a specific group of subscribers to access fax messages. The fax box of the group is reached directly via the call number of the fax group.

Parameter Description of Tabs:

- **Voicemail groups**
- **Fax groups**

Parameters	Description
<b>Voicemail groups</b>	
<b>Voicemail group</b>	Name of the voicemail group
<b>Pilot</b>	Call number of the voicemail group
<b>Type</b>	Type of voicemail group
<b>Number of users</b>	Number of members in the voicemail group
<b>Number of messages</b>	Number of new voicemails for the voicemail group
<b>Users</b>	Members of the voicemail group
<b>Fax groups</b>	
<b>Fax Group</b>	Name of the Fax group
<b>Pilot</b>	Call number of the Fax group
<b>Number of users</b>	Number of members in the Fax group
<b>Number of faxes</b>	Number of new fax messages for the Fax group
<b>Users</b>	Members of the Fax group

### 27.4.3.5 OpenScape Business UC Suite > Templates

Parameter Description of Tabs:

- **SMS Templates**

Parameters	Description
<b>Edit</b>	Placeholders, which can be selected individually under "VSL Fields", can be inserted into the Recipient, Subject or Text fields, respectively.

### 27.4.3.6 OpenScape Business UC Suite > external directory

Parameter Description of Tabs:

- **External directory**

Parameters	Description
	Manual addition of individual contacts to the external directory. The characters must match the UTF-8 format (e.g., umlauts are not displayed)

Parameter Description of Tabs:

- **Import External Directory**

Parameters	Description
<b>XMPP ID</b>	Address of an external user, which is integrated via XMPP in the UC Suite; for instant messaging and transmitting the presence status (format: mueller@unify.com/home)

### 27.4.3.7 OpenScape Business UC Suite > External Providers Config

Parameter Description of Tabs:

- **Contact Provider > Exchange**

Parameters	Description
<b>Add/Edit</b>	Input of access data for the Exchange Server. In a Microsoft environment, the Active Directory Server (ADS) or the Exchange Server also serves as the LDAP server.
<b>Name</b>	Name of this external offline directory.
<b>Server address</b>	DNS name or IP address of the Exchange server.
<b>User Name / Password</b>	User name and password for accessing the remote Exchange server.

Parameter Description of Tabs:

- **Contact Provider > LDAP**

Parameters	Description
<b>Add/Edit</b>	Access data of the LDAP server.
<b>Name</b>	Name for this external offline directory
<b>Server address</b>	DNS name or IP address of the LDAP server.
<b>Port</b>	Port number of the external LDAP server

Parameters	Description
User Name / Password	User name and password for accessing the remote LDAP server.
LDAP Base Distinguished Name	LDAP base distinguished name, e.g., dc=example-for-a-domain, dc=net.
Title, First Name, Last Name, Business Ph. 1, Business Ph. 2, Private, Mobile/Cell, Company, Company Ph., Postal Address, State or Region, Country, Post Code, E-mail, Pager, Facsimile Phone Number, XMPP ID and City	During the configuration of an external offline directory, the administrator can adapt the mapping of fields to the names of the used LDAP server. Deleted fields are ignored when searching for names via phone numbers. The search always occurs with the last 4 positions of the phone number preceded by a wildcard. You can deactivate the search for names via phone numbers for incoming calls. Enter the corresponding field name of the LDAP server in each case.

Parameter Description of Tabs:

- **Contact Provider > MSSQL**

Parameters	Description
Add/Edit	Access data of the Microsoft SQL Server
Name	Name for this external offline directory
Server address	DNS name or IP address of the Microsoft SQL Server
User Name / Password	User name and password for accessing the Microsoft SQL server
DB Name	Name of the database.

Parameter Description of Tabs:

- **Calendar Provider > Exchange**

Parameters	Description
Exchange Calendar Integration	The calendar integration is used for the automatic creation of Outlook appointments under Windows when the user is absent. If the Outlook appointments are not to be stored in the local PST file of the user, but on the Exchange server instead, the requisite access data must be entered here.
Enable Exchange calendar integration	Enable the Exchange calendar integration
Server URL	Information on the usage of the various Microsoft Exchange servers can be found in the Unify Experts wiki at <a href="http://wiki.unify.com/wiki/OpenScope_Business#Microsoft_Exchange_Server">http://wiki.unify.com/wiki/OpenScope_Business#Microsoft_Exchange_Server</a> .

### 27.4.3.8 OpenScope Business UC Suite > Contact Center

Parameter Description of Tabs:

- **Schedule**
- **Queue**
- **Grade of Service**
- **VIP Caller Priorities**
- **VIP Call List**

- Preferred Agents
- Contact Center Breaks
- Simple Wrapup
- Multiple Wrapup
- Queue Bindings

### Schedule

A schedule is used to define how incoming calls are to be handled on certain days and at specific times. For each queue, a schedule can be defined with rules (Call Control Vectors or CCVs) to determine how incoming calls are to be handled on specific dates and at specific times. A schedule, in turn, must have at least one rule (called a Call Control Vector or CCV) assigned to it. The rules determine how incoming calls for a queue are to be handled during the time period to which the schedule applies. Rules apply only to calls and not to faxes and e-mails.

For detailed information on configuring schedules, see [Configuration Procedure](#)

Parameters	Description
<b>Schedule</b>	Schedule Name
<b>Queue</b>	Name of the queue to which the schedule is assigned.
<b>Group number</b>	Phone number of the UCD group, which was set up during the basic configuration of the Contact Center.
<b>Schedule</b>	
<b>Schedule Name</b>	Schedule Name
<b>Default CCV</b>	Displays the default rule for the schedule, which applies to a queue 24 hours a day and 365 days in the year when assigned.  If different rules are to applied at certain times (breaks, weekends, holidays, vacations, etc.), these can be assigned to the schedule as exception rules (Exception CCV).
<b>Queues</b>	
<b>Queue Name</b>	Name of the queue to which this schedule is assigned.
<b>Queue Active</b>	Indicates whether the queue is active or inactive.
<b>Exceptions</b>	
<b>CCV</b>	Name of the exception rule (exception CCV).  Exception rules define how incoming calls received during certain exceptional times (break, weekend, holiday, vacation, etc.) are to be handled. Holiday schedules have precedence over the other schedules and rules of a queue.
<b>Description</b>	Descriptive text for the exception rule
<b>Type</b>	Type of the exception rule
<b>Start Date</b>	Date for the beginning of the exception rule
<b>End Date</b>	Date for the end of the exception rule
<b>Start Time</b>	Time for the beginning of the exception control
<b>End Time</b>	Time for the end of the exception rule

## Queue

Queues are the basis of the Contact Center. Calls, faxes and e-mails for a queue can be handled, depending on the skill levels of agents, the priorities and waiting periods. Announcements can be played for waiting callers.

For detailed information on configuring queues, see [Configuration Procedure](#)

Parameters	Description
<b>Queue</b>	Queue Name
<b>Queue Active</b>	Indicates whether the queue is active or inactive.
<b>Pilot</b>	Phone number (pilot) for incoming faxes  Faxes to this phone number will then be added to the queue and treated as incoming calls.
<b>General Settings</b>	
<b>Queue Name</b>	Queue Name
<b>Queue Active</b>	Definition of the queue status
<b>Queue Active: Inactive</b>	The queue is not active.
<b>Queue Active: Active</b>	The queue is active.
<b>Group number</b>	Phone number of the UCD group, which was set up during the basic configuration of the Contact Center.
<b>Phone Switch</b>	Displays the CSP entry
<b>Schedule</b>	Displays the assigned schedule
<b>Queue Alarm Count</b>	Alarm threshold number  If the number of calls waiting in the queue exceeds the number specified here, the queue symbol for the agent changes from green to orange.  Default value: 3 calls
<b>Queue Alarm Time</b>	Alarm threshold time in seconds  If the waiting time for a queued call specified here is exceeds the time specified here, the corresponding item in the list of Contact Center calls for the agents changes to red.  Default value: 5 seconds
<b>Missed Call Timeout</b>	Missed call timeout in seconds  If a call is not answered after the time specified here, it is forwarded to the next free agent.  Default value: 5 seconds
<b>Abandoned Call Threshold</b>	Threshold value for abandoned calls in seconds  The time specified here determines whether or not an abandoned call is included in the statistics (i.e., in a report). Calls abandoned after the specified time has elapsed are included in the statistics.  The abandoned calls threshold filter is not available in the Summary Report per Queue.  Default value: 5 seconds

**Expert mode**  
Applications

<b>Parameters</b>	<b>Description</b>
<b>Screen Pop Enabled</b>	When this flag is activated, a screen pop to display and enter customer data appears in myAgent for incoming calls.  Screen pops are needed to accept and execute callbacks and to accept faxes and e-mails.  Default value: Disabled
<b>Wrapup Mode</b>	Definition of the wrapup mode
<b>Wrapup Mode: No Wrapup</b>	No wrapup reasons can be defined for the queue.
<b>Wrapup Mode: Simple Wrapup</b>	One or more wrapup reasons can be defined for the queue.
<b>Wrapup Mode: Multiple Wrapup</b>	One or more wrapup reasons can be defined for the queue and then classified into groups and subgroups.
<b>Screenpop Time Out</b>	Screenpop timeout in seconds .  If is set to 0 then myAgent will implicitly request 20s of screen pop time.  Default value: 20 seconds
<b>Priorities</b>	If an agent is assigned to multiple queues, the queue priority can be used to define whether calls for a queue with higher priority should be forwarded to this agent with precedence over calls for other queues.
<b>Queue depth mode</b>	Definition of the queue depth mode
<b>Queue depth mode: Static</b>	In case that the Queue Depth mode is set to Static, WLS and Queue Depth Size can be configured.
<b>Queue depth mode: None</b>	In case that Queue Depth is set to None the WLS Parameter can be configured and affects also the UCD configuration but parameter Queue Depth Size cannot be set
<b>WLS</b>	The number of voice calls which are waiting to be connected to an agent.
<b>Queue depth size</b>	The summary of the waiting loop size (WLS) and the calls on agent.
<b>Queue Pilots</b>	
<b>Inbound Fax Pilots</b>	Phone numbers (pilots) for incoming faxes  Faxes to these phone numbers will then be added to the queue and treated as incoming calls.
<b>Inbound E-mail Service</b>	E-mail addresses for incoming e-mails  E-mails sent to these addresses are placed in the queue and treated like incoming calls.
<b>Miscellaneous</b>	
<b>Return Email Address</b>	Sender E-mail address for sent emails  The e-mail address specified here is displayed to the recipient when an e-mail is sent by an agent.
<b>Intelligent Call Routing</b>	When this flag is activated, incoming calls are automatically forwarded to the agent with whom the caller was last connected, As a prerequisite, no preferred agent must have been defined for the caller.  Default value: Disabled

### Grade of Service

The Grade of Service can be used to assess the response rate of the queue. This is achieved by comparing the waiting time for callers in the queue with target values, which can be specified individually for each queue here.

For each call to an appropriate queue, the service level is determined after the call and committed to the database. The Grade of Service can be evaluated by agents with the authorization level of a Supervisor or Administrator by using the myAgent application.

For detailed information on defining target values for the Grade of Service, see [Configuration Procedure](#)

Parameters	Description
Queue	Queue Name
Queue Active	Indicates whether the queue is active or inactive.
Group number	Phone number of the UCD group, which was set up during the basic configuration of the Contact Center.
Grade of Service	The horizontal axis shows the waiting time in the queue in intervals of 10 seconds, and the vertical axis shows the target value for the Grade Of Service as percentage values. The red dots specify the target values for the quality of switching in the queue.  Quality assessments can then be made by comparing these target values with the actual waiting times for callers in the queue.

### VIP Caller Priorities

The VIP Caller Priority can be defined individually for each queue in order to specify whether callers included in the VIP Call List should be given preferential treatment.

The values for the VIP Caller Priority can be defined freely, depending on the waiting time for callers in a queue. This determines the level of preference for VIP callers as opposed to normal callers.

When a VIP caller activates an agent callback (by recording a voicemail with a callback request), the agent callback is retained in the queue instead of the VIP caller. The VIP caller priority is not applied here.

For detailed information on defining the VIP caller priority, see [Configuration Procedure](#)

Parameters	Description
Queue	Queue Name
Queue Active	Indicates whether the queue is active or inactive.
Group number	Phone number of the UCD group, which was set up during the basic configuration of the Contact Center.
VIP Caller Priority	The horizontal axis shows the waiting time in the queue in intervals of 30 seconds, and the vertical axis shows the priority of normal callers who are not registered in the VIP call list directory. The red dots define the priority of normal callers as opposed to VIP callers.

### VIP Call List

Callers who have already been registered in the communication system (external directory) can be added to the VIP call list. In addition, call number patterns can be entered. A call number pattern consists of a specific sequence of digits and a wildcard (placeholder). It can thus be used to transfer all employees of a company to the VIP call list, for example.

For detailed information on configuring the VIP call list, see [Configuration Procedure](#)

Parameters	Description
<b>Queue</b>	Queue Name
<b>Queue Active</b>	Indicates whether the queue is active or inactive.
<b>Group number</b>	Phone number of the UCD group, which was set up during the basic configuration of the Contact Center.
<b>VIP Call List</b>	Displays the callers and call number patterns included in the VIP call list.  The further right the scroll bar is for a caller or call number pattern, the higher the priority over the other callers or call number patterns contained in the VIP call list.

### Preferred Agents

Every caller can be assigned one or more preferred agents of a queue. In such cases, the communication system first tries to switch the caller and his callback requests through to a preferred agent. If multiple preferred agents have been specified, a priority (sequence) can be defined to determine the order in which these agents are connected.

If no preferred agent is available, the call is forwarded to any available agent.

For details on defining preferred agents, see [Configuration Procedure](#)

Parameters	Description
<b>Queue</b>	Queue Name
<b>Queue Active</b>	Indicates whether the queue is active or inactive.
<b>Group number</b>	Phone number of the UCD group, which was set up during the basic configuration of the Contact Center.
<b>Preferred Agents</b>	Displays the preferred agents for the callers indicated in the customer list  If multiple preferred agents were defined for a caller, the list position shows the priority over the other preferred agents. The higher an agent is positioned in the list, the higher the priority of that agent.
<b>Display only customers who have agent associations</b>	When this flag is activated, only the callers for whom at least one preferred agent was defined are displayed in the customer list  Default value: Disabled

### Contact Center Breaks

In order to allow every agent the chance to take a defined break, Contact Center breaks of different lengths can be defined. Contact Center breaks are available system-wide and can be selected by an agent via myAgent as required.



For details on defining Contact Center breaks, see [Configuration Procedure](#)

Parameters	Description
<b>Name</b>	Name of the Contact Center break
<b>Duration</b>	Duration of the Contact Center break in minutes
<b>Active</b>	Indicates whether the Contact Center break is active or inactive.

### Simple Wrapup

One or more wrapup reasons can be defined here for queues with the wrapup mode "Simple Wrapup".

Wrapup reasons can be used to assign incoming calls to specific categories (orders, complaints, service, etc.). The assignment is made by an agent after completing the call (during the wrap-up time) by entering the appropriate wrapup reason using myAgent.

For details on defining wrap-up reasons, see [Configuration Procedure](#)

Parameters	Description
<b>Queue</b>	Name of the queue for which simple wrapup was configured.
<b>Description</b>	Descriptive text for the wrapup reason.

### Multiple Wrapup

For queues with the wrapup mode "Multiple Wrapup", one or more wrapup reasons can be defined here and then classified into groups and subgroups.

Wrapup reasons can be used to assign incoming calls to specific categories (orders, complaints, service, etc.). The assignment is made by an agent after completing the call (during the wrap-up time) by entering the appropriate wrapup reason using myAgent.

For details on defining wrap-up reasons, see [Configuration Procedure](#)

Parameters	Description
<b>Queue</b>	Name of the queue that was configured for multiple wrapup. The groups and subgroups already defined for this queue are displayed.
<b>Description</b>	Descriptive text for the wrapup reason.

### Queue Bindings

Queues bindings are used to assign agents to one or more queues.

For details on assigning agents to queues, see [Configuration Procedure](#)

Parameters	Description
<b>Queue</b>	Queue Name
<b>Queue Active</b>	Indicates whether the queue is active or inactive.
<b>Group number</b>	Phone number of the UCD group, which was set up during the basic configuration of the Contact Center.
<b>Agent</b>	Agent assigned to the queue.
<b>Agent Assignment (Binding)</b>	
<b>Type</b>	Agent Type The following options are possible: <ul style="list-style-type: none"> <li>• Primary Agent: The agent receives calls regardless of the load on the queue.</li> <li>• Overflow Agent: The agent receives calls only when the queue overflows.</li> </ul>
<b>Overflow after seconds in queue</b>	Only for Overflow Agent: Overflow time in seconds When the overflow time has elapsed, a call is routed to an overflow agent.
<b>Overflow after calls in queue</b>	Only for Overflow Agent: Number of calls Calls that exceed this maximum number are routed to an overflow agent.
<b>Skill Level</b>	Displays the skill level in percent The skill level controls the distribution of calls to agents in a queue. Agents with higher skill levels are given preference during the call distribution. In cases where all agents have the same skill level, the longest idle agent receives the call.
<b>Enable agent callback</b>	When this flag is activated, the agent receives callback requests in the form of voice messages.
<b>Wrap up</b>	Automatic wrapup time in seconds

### 27.4.3.9 OpenScape Business UC Suite > Schedules

Parameter Description of Tabs:

- **Edit/Add**

Parameters	Description
<b>Auto Attendant</b>	Configure the AutoAttendant function for the UC Suite (Company AutoAttendant)
<b>Edit schedule</b>	This schedule and the rules contained in it (Call Control Vectors or CCVs) define how incoming calls are to be handled on specific dates and at specific times.
<b>Schedule Name</b>	The schedule can be saved under a user-defined name. It is recommended that you enter a meaningful name here.
<b>Default CCV</b>	The schedule, in turn, must have at least one rule (called a Call Control Vector or CCV) assigned to it. Rules determine how incoming calls are to be handled during a specific time period. Rules apply only to calls and not to faxes and e-mails. Rules are created with the graphical rule editor (CCV Editor) by combining predefined CCV objects. Several predefined, standardized templates are available; these can be changed as desired and adapted to specific needs.

Parameters	Description
<b>Edit/Add</b>	Edit the selected rule or add a new rule (via the rule editor)
<b>Queues</b>	It is recommended to activate only one queue per schedule (set only one check mark).
<b>Queue Name</b>	The queue can be saved under a user-defined name. It is recommended that you enter a meaningful name here.
<b>Queue Active</b>	The queue can be enabled or disabled.
<b>Schedule</b>	Select the associated schedule.
<b>Pilot</b>	Call number of the associated virtual port in the communication system.
<b>Exceptions</b>	A schedule with an assigned default rule applies to a queue 24 hours a day, 365 days a year. If different rules are to be applied at certain times (breaks, weekends, holidays, vacations, etc.), these can be assigned to the schedule as exception rules (Exception CCV). This means that you can define how incoming calls are to be handled during the holiday schedule, for example. Holiday schedules have precedence over the other schedules and rules.
<b>CCV</b>	Selection of the exception rule (exception CCV).
<b>Description</b>	Enter a description for the exception schedule
<b>Type</b>	Within the time range of one or more weekdays / Freely definable within the time date range / Holiday schedules for a specific date range
<b>Start Date</b>	Beginning of the exception (date)
<b>End Date</b>	End of the exception (date)
<b>Start Time</b>	Beginning of the exception (time)
<b>End Time</b>	End of the exception (time)
<b>(Weekday)</b>	The exception will apply to one or more weekdays

### 27.4.3.10 OpenScape Business UC Suite > File Upload

Parameter Description of Tabs:

- **Upload audio files**

Parameters	Description
<b>Upload Destination</b>	Application for which the new announcement is used
<b>Upload Destination: Auto Attendant</b>	Announcements for the Automatic Attendant
<b>Upload Destination: Profiles</b>	Announcements for some or all users of UC Suite
<b>Upload Destination: Voicemail Greeting</b>	Voicemail announcements for all or individual users of UC Suite
<b>Upload Destination: VM Group Greeting</b>	Greeting for a group voicemail box
<b>no key for: uploader</b>	The announcement is available for upload as a PCM file with the following properties: 8 kHz, 16 bit, mono. The maximum length for the audio file name is 30 characters.
<b>Recorder</b>	The announcement is recorded via the telephone of an extension

Parameters	Description
<b>Wave File</b>	
<b>Download</b>	Downloaded announcements.
<b>Delete</b>	Delete downloaded announcements.
<b>Rename</b>	Rename downloaded announcements.
Recorder	
<b>File name</b>	Specifies the file name of the announcement to be recorded.
<b>Extension</b>	Selects the phone with which the announcement is to be recorded.
<b>Call</b>	Calls to the phone with which the announcement is to be recorded.
<b>Play</b>	Plays back the recorded announcement.
<b>Record</b>	Starts recording the announcement.

Parameter Description of Tabs:

- **Central Fax Cover Page Upload**

Parameters	Description
<b>Central Fax Cover Page Upload</b>	
<b>Ocp file</b>	Fax cover page available as ocp file
<b>Name</b>	
<b>Description</b>	

### 27.4.3.11 OpenScape Business UC Suite > Conferencing

Parameter Description of Tabs:

- **Conferencing**

Parameters	Description
<b>Name</b>	Name of the conference (assigned by the user)
<b>Owner</b>	Name of the user of who initiated the conference
<b>Next Scheduled</b>	Next scheduled start time
<b>Active</b>	
<b># Members</b>	Number of conference participants, including conference controller
<b>Display</b>	Participants of the selected conference

### 27.4.3.12 OpenScape Business UC Suite > Site List

Parameter Description of Tabs:

- **Site List**

Parameters	Description
Site Name	Sites in the networked communication system (see Basic Settings > Gateway Properties)
Site Address	IP address of UC Card Booster, UC Booster Server or the communication system
Site Port	Server Port
Site IP Trunks	Site IP trunks, if available
Online Status	Connection status of the communication system at the site

### 27.4.3.13 OpenScape Business UC Suite > Server

Parameter Description of Tabs:

- **General Settings**
- **Live Record**
- **Logging**
- **Notifications**
- **Maintenance**
- **Voicemail**

Parameters	Description
<b>Office Hours</b>	
Start Time	Beginning of the daily office hours (business hours) Setting for the presence status of the UC clients Default value: 7.00 hours
End Time	End of the daily office hours (business hours) Setting for the presence status of the UC clients Default value: 19.00 hours
<b>Length of Password</b>	
Lengths	Length of the password for the UC clients. Minimum value is 6. <b>NOTE:</b> Changing the length of the password resets the passwords for all users. Default value: 6
<b>Call number of intercept position</b>	
Target Number	Call number of intercept position <b>INFO:</b> Enter the call number of the intercept position configured in the communication system.
<b>Instant message</b>	
Disable instant messaging	When this flag is activated, the sending of instant messages is impossible. Default value: Disabled

**Expert mode**  
Applications

Parameters	Description
<b>Analog Extensions</b>	
<b>Analog User Mode</b>	Defines how analog stations are displayed in the internal directory Default value: Show All
<b>Analog User Mode: Show All</b>	All analog stations are displayed in the internal directory
<b>Analog User Mode : Show named only</b>	Only analog stations with a name are displayed in the internal directory.
<b>Analog User Mode: Not shown</b>	No analog station is displayed in the internal directory.
<b>Extension</b>	
<b>Max. internal length</b>	Maximum number of digits for internal call numbers To prevent toll fraud, the dialing of long internal call numbers is prohibited. Default value: 4
<b>Min. external length</b>	Minimum number of digits for external call numbers Default value: 3
<b>Transfer</b>	
<b>Normal Auto Attendant SST</b>	When this flag is activated, the call will be transferred, regardless of whether the destination is free, busy or unavailable. Default value: Enabled
<b>Journal</b>	
<b>Allow deleting of journal entries</b>	This flag allows or prohibit the possibility for a user to delete a journal entry or not.
<b>Fax Format</b>	
<b>Use PDF as fax format</b>	If the flag is checked the received Fax is in PDF format, otherwise the received fax is in tiff format. PDF format, applies only when sent a fax to OLI plugin and not with myPortal.
<b>External Provider</b>	
<b>Slow External Provider</b>	This flag improves the response time of the right mouse click to an e-mail.
<b>Name Resolution</b>	
<b>Length of verification</b>	A digit from 4 to 8 must be entered to define the length of CLI numbers for the search in LDAP in myPortal for Desktop and myPortal for Outlook. The highest number (8) can be configured for more exact search and improved system performance Default value: 4
<b>Dial by name search local extension only</b>	
<b>Dial by name search local extension only</b>	When this flag is checked the "dial by name" function is limited to the acting node (local function). When this flag is unchecked the old function is still available which considers all user in the network but playing the announcement only after selection of a local user.
<b>TLS</b>	

Parameters	Description
<b>Using TLS for client connections</b>	Due to network reasons it might be necessary to switch off the secure client server connection.  This should be done in very specific cases only!
<b>Live Record</b>	
<b>Live Record</b>	When this flag is activated, the recording of calls and conferences is possible.  Default value: Enabled
<b>Play prompt before recording</b>	When this flag is activated, an announcement is played before a recording starts.  Default value: Disabled
<b>Play pip tone during recording</b>	For OpenScope Business S, when this flag is activated, a warning tone is played during the recording.  Default value: Enabled
<b>System Logging</b>	
<b>Log Trace Messages (Verbose)</b>	When this flag is activated, trace messages are recorded in a log file on a daily basis.  Default value: Disabled
<b>Client Logs</b>	
<b>Client log path</b>	Storage path for client log files (log files of the UC Suite)
<b>Enable log upload</b>	When this flag is activated, the client logs are stored on the hard disk of the UC Booster Card (OCAB), the UC Booster Server or the OpenScope Business S communication system.  Default value: Enabled
<b>Enable client logging</b>	Activating this flag enables the recording of client logs.  Default value: Enabled
<b>Email Notifications</b>	
<b>Enable email notifications of system errors</b>	When this flag is activated, E-mail notifications will be sent to the entered recipients to provide advance warnings about critical disk usage levels for the hard disk, for example, or about errors.  Default value: Enabled
<b>Disable myPortal invitation email</b>	When this flag is activated, conference participants will not be automatically informed about conferences by e-mail.  Default value: Disabled
<b>Recipients</b>	E-mail addresses of the individuals to whom e-mail notifications are to be sent.
<b>Conditions</b>	
<b>Send Critical Messages</b>	When this flag is activated, e-mail notifications are sent for critical messages (e.g., system errors)  Default value: Enabled
<b>Send Crash Notifications</b>	When this flag is activated, e-mail notifications are sent for system crashes.  Default value: Enabled

Parameters	Description
<b>On error reporting, send the last ... lines from the log file</b>	Defines the number of lines of a log file to be sent by e-mail. Default value: 100
<b>Maintenance</b>	
<b>Begin system maintenance at</b>	Defines at what time the following data is deleted on a daily basis when the individual retention periods have expired: <ul style="list-style-type: none"> <li>• Messages</li> <li>• Call information in the call journal (call history)</li> <li>• Calls recorded with myAgent (contact center)</li> <li>• Faxes and e-mails received and sent for the Contact Center</li> <li>• Log files</li> </ul> Default value: 2.00 hours
<b>Message</b>	
<b>Keep inbox messages for</b>	Retention period in days for voice messages in the Inbox Default value: 60
<b>Keep played / read messages for</b>	Retention period in days for played/read voice messages Default value: 30
<b>Keep saved messages for</b>	Retention period in days for saved voice messages Default value: 365
<b>Keep deleted messages for</b>	Retention period in days for deleted voicemails Default value: 30
<b>Fax Ph.</b>	
<b>Keep inbox faxes for</b>	Retention period in days for faxes in the Inbox Default value: 30
<b>Keep read faxes for</b>	Retention period in days for read faxes Default value: 30
<b>Keep deleted faxes for</b>	Retention period in days for deleted faxes Default value: 30
<b>Keep sent faxes for</b>	Retention period in days for sent faxes Default value: 30
<b>Calls Information Maintenance</b>	
<b>Keep call history for</b>	Retention period in days for calls in the journal Default value: 30
<b>Contact Center</b>	Retention period in days for calls recorded with myAgent and for the faxes and e-mails received and sent for the Contact Center Default value: 30
<b>Log File Maintenance</b>	



Parameters	Description
<b>Keep log information for</b>	Retention period in days for log files Default value: 10
<b>Reports</b>	
<b>Reset Password</b>	Resets reset the myReports administrator password to the default password
<b>Voicemail</b>	
<b>VoiceMail Language</b>	Default language of the voicemail box for the menu prompts and the internal system announcements
<b>VoiceMail Message Play Order</b>	Defines the sequence in which voicemail messages are played Default value: Newest First
<b>VoiceMail Message Play Order: Newest First</b>	The most recent voicemail message is presented first.
<b>VoiceMail Message Play Order: Oldest First</b>	The oldest voicemail message is presented first.
<b>VoiceMail Message Recording time</b>	Defines the maximum recording time for a voicemail message in seconds Default value: 900
<b>VoiceMail Mode</b>	Defines the functionality of the voicemail box Default value: Full
<b>VoiceMail Mode: Full</b>	Full functionality of the voicemail box
<b>VoiceMail Mode: Short Menu</b>	After the status-based or personal announcement is made, a connection to the operator is offered.
<b>VoiceMail Mode : No VoiceMail Menu</b>	After the greeting announcement is played, the caller is directly taken to the voice recording.
<b>Allow callback from VM to known number only</b>	When this flag is activated, any callers whose numbers are not stored in the UC client will be prevented from accessing the voicemail box. Default value: Enabled

### 27.4.3.14 OpenScape Business, UC Suite > Profiles

Parameter Description of Tabs:

- **Add / Edit**

Parameters	Description
<b>Profiles</b>	User profiles store the settings of the UC Suite users. One or more users (members) can be assigned to a user profile. All members of this profile have the same settings (at first). Multiple profiles can be created to define different settings for different user groups.
<b>Name</b>	Name of the profile (free input)

Parameter Description of Tabs:

- **Assign Users**

Parameters	Description
<b>Users</b>	Users to whom the profile applies
<b>Personal Details</b>	
<b>My Personal Details</b>	Selected personal data for the assigned users. The lock symbol determines whether users can change these settings themselves.
<b>My Preferences</b>	
<b>Presentation</b>	Skin and language of the UC client of the associated user. The lock symbol determines whether users can change these settings themselves.
<b>Notification</b>	Notifications for the assigned users. The lock symbol determines whether users can change these settings themselves.
<b>Outlook Connectivity</b>	Calendar integration for the assigned users. The lock symbol determines whether users can change these settings themselves.
<b>Miscellaneous</b>	Automatic return to the presence status "Office"; transfer method and retention period of the call journal for the assigned users. The lock symbol determines whether users can change these settings themselves.
<b>Call Rules</b>	
<b>Forwarding destinations</b>	Forwarding destinations for incoming calls for the assigned users, depending on the presence status. The lock symbol determines whether users can change these settings themselves.
<b>Communications</b>	
<b>Voicemail settings</b>	Recording of voice messages for the assigned users, depending on the presence status. The lock symbol determines whether users can change these settings themselves.
<b>VM Notification</b>	Notification of new voice messages for the assigned users. The lock symbol determines whether users can change these settings themselves.
<b>Fax Notification</b>	Notification of new fax messages for the assigned users. The lock symbol determines whether users can change these settings themselves.
<b>Profiles</b>	
<b>Profiles</b>	Personal AutoAttendant for the assigned users. The respective users must record an announcement for the selection. The lock symbol determines whether users can change these settings themselves.
<b>Sensitivity</b>	
<b>Security and Access</b>	Allow listening to voicemail with myAttendant and checking the voicemail box from the own phone without a password. The lock symbol determines whether users can change these settings themselves.
<b>Presence Visibility</b>	Internal subscribers who are allowed to see the presence status. The lock symbol determines whether users can change these settings themselves.
<b>VoiceMail Presence</b>	Internal or external callers who are to be informed about the presence status through automated announcements of the voicemail box. The lock symbol determines whether users can change these settings themselves.

### 27.4.3.15 OpenScape Business, UC Suite > Fax Headlines

Parameter Description of Tabs:

- **Edit**
- **Add**
- **Delete**

Parameters	Description
<b>ID</b>	ID that displays the header for selection in Fax Printer
<b>Name</b>	Name of the header (must be unique).
<b>Text</b>	Placeholders for the date/time, company name, user name, company phone number, page number and number of pages can be inserted.

### 27.4.3.16 OpenScape Business UC Suite > Skin Settings

Parameter Description of Tabs:

- **Skin Settings**

Parameters	Description
<b>Browse</b>	Navigation to the storage location of the file containing the skin settings to be loaded.
<b>Upload</b>	Loads the file with the skin settings.
<b>Delete</b>	Deletes the file with the skin settings.

## 27.4.4 Web Services

The functions for configuring of the web interfaces such as Web Collaboration, for example, are grouped under **Web Services**.

### 27.4.4.1 Web Services > XMPP

Parameter Description of Tabs::

- **Edit XMPP parameters**

Parameters	Description
<b>XMPP mode on</b>	Enable XMPP
<b>XMPP Standalone</b>	The system is a stand-alone system

Parameters	Description
<b>XMPP in the network</b>	The system is in a network
<b>XMPP Domain</b>	Specifies the web site under which the system is accessible on the Internet. In the form: oso.examplefor-a-domain.com.
<b>Secure connections (TLS) enabled</b>	Use of only secure connections to other servers

## 27.4.4.2 Web Services > Web Collaboration

For the integration of web collaboration via a public server (web collaboration server as a service on the Internet) or via a custom server (web collaboration server in the customer network or with a partner).

Parameter Description of Tabs:

- **Web Collaboration Server**

Parameters	Description
<b>Server Type</b>	Selection of the web collaboration server.
<b>Server Type: Public Server</b>	The web collaboration server is a public server and is located on the Internet. A secure https connection is used for this. In addition, a license number and a password are required. By default, TCP port 5100 is used for this purpose.
<b>Server Type: Public Server (Demo Mode/Evaluation Mode)</b>	The web collaboration can be tested for 5 minutes. No input of an IP address, license number and password are required for this.
<b>Server Type: Custom Server</b>	The web collaboration server is a custom server and is located in the customer network or with a partner. Either a secure https connection or an unsecured http connection can be used for this. When connecting via https, a license number and a password are additionally required. By default, TCP port 5004 is used for this purpose.
<b>Server Type: No Web Collaboration Server</b>	No web collaboration server is being used. The option to start a web collaboration session is disabled in the UC clients.
<b>URL / IP address</b>	Enter the URL or IP address of the appropriate web collaboration server. Public server via https and custom server via http or https.  Example:  <code>http://&lt;web collaboration server IP address&gt;:5004/OscInterface</code> <code>https://&lt;web collaboration server IP address&gt;:5100/XMLRPSecure</code>
<b>License number</b>	License number for the secure connection to the web collaboration server.
<b>Password</b>	Password for the secure connection to the web collaboration server.

## 27.4.5 Open Directory Service

The functions for configuring the Open Directory Service are grouped under **Open Directory Service**.

### 27.4.5.1 Open Directory Service > Basic Settings

Parameters	Description
<b>Enable/Disable Open Directory Service</b>	Default value: disabled
<b>LDAP server login credentials</b>	Login data of the external database server. Open Directory Service must be authorized to access the external database; if necessary, a separate user account must be added on the server for this purpose.

### 27.4.5.2 Open Directory Service > Data sources > OpenScape Business

Parameter Description of Tabs::

- **Overview of the configured data sources**

Parameters	Description
<b>OpenScape Office directories</b>	Internal directory of UC Suite. The directory is permanently assigned to the Open Directory Service and cannot be deleted or changed.
<b>Speed Dials</b>	Central speed-dial numbers. The directory is permanently assigned to the Open Directory Service and cannot be deleted or changed.
<b>Add</b>	External data sources for contact information from databases with read access via ODBC

Parameter Description of Tabs::

- **Edit data source**

Parameters	Description
<b>New data source</b>	The parameters of the added data sources can be changed here

### 27.4.5.3 Open Directory Service > Data sources > LXV3

Parameters	Description
<b>Speed Dials</b>	Central speed-dial numbers. The directory is permanently assigned to the Open Directory Service and cannot be deleted or changed.

## 27.4.5.4 Open Directory Service > Data sources > LXV3

Parameters	Description
<b>Overview of the configured data sources</b>	An LDAP data output mapping determines which of the fields in the data schema of the Open Directory Service are to be output via LDAP, e.g., for specific LDAP clients or for different groups of subscribers who do not want to see all the details, but only a defined subset. The LDAP data output mapping "web" is available by default and cannot be deleted or changed. All fields of the data schema in the Open Directory Service are permanently assigned to the LDAP output in it. You can also configure other LDAP data output mappings.
<b>Add</b>	Add more data output mappings. LDAP clients can access a specific LDAP data output mapping via the dc parameter in the LDAP login, for example: dc=web.

## 27.4.5.5 Open Directory Service > Maintenance

Parameter Description of Tabs::

- **Maintenance**

Parameters	Description
<b>Check/Restart Open Directory Service</b>	Status indicator of the Open Directory Service (grey = disabled, red = incorrect configuration or data source not available, green = enabled)
<b>Restart</b>	Restart the Open Directory Service

## 27.4.5.6 OpenStage Gate View

OpenStage Gate View can be enabled or disabled under **OpenStage Gate View**, and the OpenStage Gate View server software can also be started from there.

## 27.4.6 OpenStage Gate View

Parameters	Description
<b>Activate</b>	Activate OpenStage Gate View
<b>Deactivate</b>	Deactivate OpenStage Gate View
<b>Login</b>	Invoke the OpenStage Gate View server software.

## 27.4.7 Application Launcher

The functions for configuring Application Launcher are grouped under **Application Launcher**.

### 27.4.7.1 Application Launcher

Parameters	Description
<b>Upload Configuration File</b>	Profile with configuration data for Application Launcher to enable the easy and fast configuration of Application Launcher on all client PCs. As soon as Application Launcher has been fully configured for an initial user, as an administrator, you can make that profile with the Application Launcher configuration data available in the communication system. All other users can then perform the configuration of Application Launcher by importing this profile.
<b>Profile</b>	Allowed file type .xml

### 27.4.8 IVM

Under **IVM**, the IP address of the IVM (Xpressions Compact), and thus the web-based configuration menu of the IVM, is called. The menu item appears only if an IVM is installed in the system.

## 27.5 Middleware

The functions for configuring the middleware are grouped under **Middleware**.

### 27.5.1 Announcement Player

Parameter Description of Tabs:

- **Announcement player settings**
- **Announcement Player Statistics**

Parameters	Description
<b>Activation</b>	
<b>Service will be started automatically</b>	Activation or deactivation of the playback device for announcements.
<b>Announcement Player Statistics</b>	The status of the announcement device is displayed here. The data is automatically updated every 5 minutes. However, the page can also be refreshed manually.

### 27.5.2 Csta Message Dispatcher (CMD)

Parameter Description of Tabs:

- **CSTA Message Dispatcher (CMD) settings**
- **CSTA Message Dispatcher (CMD) Statistics**

Parameters	Description
<b>Activation</b>	
<b>Service will be started automatically</b>	Activation or deactivation of the CSTA Message Dispatcher (CMD). The CMD sets up the connection between the OpenScape Business TAPI 120 clients and the communication system and is required for the functionality.
<b>Auto Registration</b>	
<b>Client auto registration enabled</b>	<p>Enable or disable the automatic registration of the clients.</p> <p>Automatic registration means that new entries are possible in the list of CTI firewall, and the CTI firewall is thus configured automatically. When all authorized clients have registered, the check mark can be removed, and new entries in the CTI firewall can be prevented.</p> <p>A PC can be authorized to control a specific extension. The TAPI/CTI licenses must be additionally assigned.</p>
<b>CTI firewall</b>	
<b>Delete</b>	Entries with a check mark in the Delete column are removed from the list of authorized clients on clicking the <b>Apply</b> button. An login will then be rejected, unless the automatic registration is enabled.
<b>Application ID</b>	Name of the PC from which an extension can be controlled. By using the PC name, DHCP can also be used for the OpenScape Business TAPI 120 PCs.
<b>Call number</b>	Internal call number of the extension to be controlled.
<b>CSTA Message Dispatcher (CMD) Statistics</b>	The status of the CMD is shown here. During the current operation, it is possible to verify for which of the OpenScape Business TAPI 120 connected to the CMD licenses may need to be assigned. The data is automatically updated every 5 minutes. However, the page can also be refreshed manually.

### 27.5.3 Csta Service Provider (CSP)

Parameter Description of Tabs:

- **Csta Service Provider (CSP) settings**
- **CSTA Service Provider (CSP) Statistics**

Parameters	Description
<b>Activation</b>	
<b>Service will be started automatically</b>	Activation or deactivation of the CSTA Service Provider (CSP). The CSP is required for the UC Suite, the DSS server (Presence Manager, only in networking), the OpenScape Business TAPI 170 and external CSTA applications.



Parameters	Description
<b>CSTA Access</b>	
<b>CSTA user ID / CSTA user password</b>	OpenScape Business TAPI 170 and external CSTA applications can only log in at the CSP with the user account configured here. If no CSTA user is configured, it is not possible to use OpenScape Business TAPI 170 or external CSTA applications at the CSP.
<b>CSTA Service Provider (CSP) Statistics</b>	The status of the CSP is shown here. You can see how many and which applications are connected with the CSP. Unknown applications are represented with 'Default'. The connection status to the individual nodes of the network or the local node can be displayed. The data is automatically updated every 5 minutes. However, the page can also be refreshed manually.

## 27.5.4 DSS Server

Parameter Description of Tabs:

- **DSS Server settings**
- **DSS Server Statistics**

Parameters	Description
<b>Activation</b>	
<b>Service will be started automatically</b>	Enable or disable the DSS server.
<b>DSS Server Statistics</b>	The status of the DSS server is displayed here. The data is automatically updated every 5 minutes. However, the page can also be refreshed manually.

## 27.5.5 Media Extension Bridge (MEB)

Parameter Description of Tabs:

- **Media Extension Bridge (MEB) settings**
- **Media Extension Bridge (MEB) Statistics**

Parameters	Description
<b>Activation</b>	
<b>Service will be started automatically</b>	Enable or disable the Media Extension Bridge.
<b>Media Extension Bridge (MEB) Statistics</b>	The status of the MEB is displayed here. The data is automatically updated every 5 minutes. However, the page can also be refreshed manually.

## 28 Appendix

This appendix contains reference information such as the supported languages, standards, configuration limits and capacities, Euro-ISDN features, codes for enabling and disabling features, feature codes using DTMF and the IP protocols and port numbers used.

### 28.1 Supported Standards

This section contains information on the supported standards.

#### Ethernet

- RFC 894 Ethernet II Encapsulation
- IEEE 802.1Q Virtual LANs
- IEEE 802.2 Logical Link Control
- IEEE 802.3u 100BASE-T
- IEEE 802.3ab Gigabit Ethernet
- IEEE 802.3X Full Duplex Operation

#### IP Routing

- RFC 768 UDP
- RFC 791 IP
- RFC 792 ICMP
- RFC 793 TCP
- RFC 2822 Internet Message Format
- RFC 826 ARP
- RFC 2131 DHCP
- RFC 1918 IP Addressing
- RFC 1332 The PPP Internet Protocol Control Protocol (IPCP)
- RFC 1334 PPP Authentication Protocols
- RFC 1618 PPP over ISDN
- RFC 1661 The Point-to-Point Protocol (PPP)
- RFC 1877 PPP Internet Protocol Control Protocol
- RFC 1990 The PPP Multilink Protocol (MP)
- RFC 1994 PPP Challenge Handshake Authentication Protocol (CHAP)
- RFC 2516 A Method for Transmitting PPP Over Ethernet (PPPoE)
- RFC 3544 IP Header Compression over PPP

#### NAT

- RFC 2663 NAT

### **IPSec**

- RFC 2401 Security Architecture for IP
- RFC 2402 AH - IP Authentication Header
- RFC 2403 IPsec Authentication - MD5
- RFC 2404 IPsec Authentication - SHA-1
- RFC 2405 IPsec Encryption - DES
- RFC 2406 ESP - IPsec encryption
- RFC 2407 IPsec DOI
- RFC 2408 ISAKMP
- RFC 2409 IKE
- RFC 2410 IPsec encryption - NULL
- RFC 2411 IP Security Document Roadmap
- RFC 2412 OAKLEY

### **SNMP**

- RFC 1213 MIB-II

### **QoS**

- IEEE 802.1p Priority Tagging
- RFC 1349 Type of Service in the IP Suite
- RFC 2475 An Architecture for Differentiated Services
- RFC 2597 Assured Forwarding PHB Group
- RFC 3246 An Expedited Forwarding PHB (Per-Hop Behavior)

### **Services**

- RFC 2597 Assured Forwarding PHB Group
- RFC 3246 An Expedited Forwarding PHB (Per-Hop Behavior)

### **Codecs**

- G.711
- G.729

### **VoIP over SIP**

- RFC 2198 RTP Payload for Redundant Audio Data
- RFC 2327 SDP Session Description Protocol
- RFC 2617 HTTP Authentication: Basic and Digest Access Authentication
- RFC 2782 DNS RR for specifying the location of services (DNS SRV)
- RFC 2833 RTP Payload for DTMF Digits, Telephony Tones and Telephony Signals
- RFC 3261 SIP Session Initiation Protocol
- RFC 3262 Provisional Response Acknowledgement (PRACK) Early Media
- RFC 3263 SIP Locating Servers

- RFC 3264 An Offer/Answer Model with the Session Description Protocol
- RFC 3310 HTTP Digest Authentication
- RFC 3311 Session Initiation Protocol (SIP) UPDATE Method
- RFC 3323 A Privacy Mechanism for the Session Initiation Protocol (SIP)
- RFC 3325 Private Extensions to the Session Initiation Protocol (SIP) for Asserted Identity within Trusted Networks
- RFC 3326 The Reason Header Field for the Session Initiation Protocol (SIP)
- RFC 3489 STUN - Simple Traversal of User Datagram Protocol (UDP) Through Network Address Translators (NATs)
- RFC 3515 The Session Initiation Protocol (SIP) Refer Method
- RFC 3550 RTP: Transport Protocol for Real-Time Applications
- RFC 3551 RTP Profile for Audio and Video Conferences with Minimal Control
- RFC 3581 An Extension to the Session Initiation Protocol (SIP) for Symmetric Response Routing
- RFC 3891 The Session Initiation Protocol (SIP) Replaces Header

#### **XMPP**

- RFC 3920 Extensible Messaging and Presence Protocol (XMPP): Core
- RFC 3921 Extensible Messaging and Presence Protocol (XMPP): Instant Messaging and Presence

#### **Other**

- RFC 959 FTP
- RFC 1305 NTPv3
- RFC 1951 DEFLATE

## **28.2 Euro-ISDN Features**

The Euro-ISDN features can be used at every Euro-ISDN port if the available hardware (phone or ISDN card, for instance) is appropriately configured. The features are either available permanently in the Central Office or activated/deactivated with codes.

The availability of features depends on the network provider. Some of the named features are subject to charges.

Topic	Explanation
Multiple Subscriber Number (MSN)	Every point-to-multipoint connection can be assigned several phone numbers. The user can assign these phone numbers to the individual terminals directly at the terminals.
Calling Line Identification Presentation (CLIP)	The actual phone number is transmitted to the called station and appears, for example, on the phone's display or in the caller list if the call is not answered. Incorrect phone numbers cannot be transmitted. Direct inward dialing from TC systems cannot be checked, however. Phone number transmission can be suppressed on a case-by-case basis or for all calls.
Calling Line Identification Restriction (CLIR)	Phone number transmission can also be deactivated either permanently or on a case-by-case basis. If deactivated, phone numbers are only displayed at specially defined B stations (emergency help lines, police, fire department).
Malicious Call Identification (MCID)	The called party can have an anonymous caller traced by the attendant console, even if phone number transmission is deactivated. A charge is applied for this feature.
Terminal Portability (TP)	This feature lets you move the ISDN phone you are using and plug it into a different ISDN jack without interrupting an ongoing call. You must park the ongoing call before you move the ISDN phone.
Subaddressing (SUB)	This function is subject to an additional charge and can be used in addition to the normal phone number. Subaddressing lets you operate a dialable phone (for example, a program on the PC) depending on the caller.
User to User Signaling (UUS)	Information can be exchanged over the D channel during connection setup and clear-down. Transmission is possible in both directions.
Closed User Group (CUG)	If you activate this feature, no calls are possible outside the user group (apart from the emergency numbers 110 and 112). External callers can also be blocked.
Call Forwarding Busy (CFB)	This call forwarding variant routes calls on busy to an arbitrary available phone. Call forwarding is performed in the attendant console. This leaves both B channels free.
Call Forwarding Unconditional (CFU)	This call forwarding variant routes calls immediately to an arbitrary available phone. Call forwarding is performed in the attendant console. This leaves both B channels free.
Call Forwarding No Reply (CFNR)	This call forwarding variant routes calls after 20 seconds (if the destination cannot be reached) to an arbitrary available telephone. Call forwarding is performed in the attendant console. This leaves both B channels free.
Call waiting (CW)	A second caller is signaled during an ongoing connection. The caller meanwhile hears the ringback tone. The camp-on connection can be accepted, declined or simply ignored.

Topic	Explanation
Toggle (Hold = Call Hold)	The Consultation feature lets you set up a second connection while another connection is already ongoing. Switching back and forth between two connections is known as toggling. The party on hold cannot overhear the other active call.
Three Party Service (3-PTY)	Two existing connections can be joined together. A three-party conference can be conducted by three subscribers.
Completion of Calls to Busy Subscriber (CCBS; automatic callback on busy)	You can activate this feature if a station called is busy. You hear a signal as soon as this station's port is free. The connection is cleared down by replacing the handset.
Advice of Charge (End) (AOCE)	You can program the application to display call charges at the end of a call. This does not take account of any discounts or tariffs.
Advice of Charge (During) (AOCD)	You can program the application to display call charges during a call. This does not take account of any discounts or tariffs.

## 28.3 Used Ports

The OpenScope Business system components use different ports, which may need to be opened in the firewall as required. For the ports of the web-based clients (e.g., myPortal to go), port forwarding must be configured in the router.

---

**INFO:** The ports identified with "O" in the list below are optional, i.e., are not permanently open in the firewall (e.g., the TFTP port is open only when Gate View is activated).

---

Description	TCP	UDP	Port number	OpenScope Business X	UC Booster Card	OpenScope Business S	UC Booster Server
<b>System components</b>							
Admin Portal (https)	X		443	X	X	X	X
CAR Update Registration	X		12061	X		X	
CAR Update Server	X		12063	X		X	
CLA	X		61740	O		O	O
CLA Auto Discovery		X	23232	X		X	X
Csta Message Dispatcher (CMD)	X		8900		X	X	X
CSTA Protocol Handler (CPH)	X		7004	X		X	
Csta Service Provider (CSP)	X		8800		X	X	X

Description	TCP	UDP	Port number	OpenScape Business X	UC Booster Card	OpenScape Business S	UC Booster Server
DHCP		X	67	X			
DLI	X		18443	X		X	X
DLSC	X		8084	X		X	X
DNS	X	X	53	X			
FTP	X		21	O		O	
FTP Passive	X		40000:40040	O		O	
Gate View	X		8000:8010		O	O	O
HFA	X		4060	X		X	
HFA Secure	X		4061	X		X	
JSFT	X		8771		X	X	X
JSFT	X		8772		X	X	X
LAS Cloud Service	X		8602	X			
LDAP server	X		389		X	X	X
Manager E	X		7000	X			
MEB SIP	X		15060		X		X
NAT traversal (NAT-T)		X	4500	X			
NTP		X	123	X			
Openfire Admin (https)	X		9091		X	X	X
OpenScape Business Multisite	X		8778		X	X	X
OpenScape Business myReports (http)	X		8101		X	X	X
OpenScape Business status server	X		8808	X		X	X
OpenScape Business user portal	X	X	8779		X	X	X
Postgres	X		5432	X	X	X	X
RTP (embedded)		X	29100:30530	X	X	X	X
RTP (server)		X	29100:30888	X	X	X	X
SIP (server)	X	X	5060	X		X	
SIP TLS SIPQ (server)	X		5061	X		X	
SIP TLS Subscriber (server)	X		5062	X		X	
SNMP (Get/Set)		X	161	X		X	
SNMP (traps)		X	162	X		X	
TFTP		X	69		O	O	O

## Appendix

### Project Planning of DSP Channels for the OpenScape Business X3/X5/X8 Communication Systems

Description	TCP	UDP	Port number	OpenScape Business X	UC Booster Card	OpenScape Business S	UC Booster Server
VSL	X		8770		X	X	X
Webadmin for Clients	X		8803	X	X	X	X
XMPP Connection Manager	X		5262		X	X	X
XMPP server	X		5269		X	X	X
<b>Web-based clients</b>							
Web-based clients (http)	X		8801	X	X	X	X
Web-based clients (https)	X		8802	X	X	X	X

---

**INFO:** For security reasons, we recommend that only https be used for the web-based clients and that port forwarding be set up from external TCP/443 to internal TCP/8802.

---

## 28.4 Project Planning of DSP Channels for the OpenScape Business X3/X5/X8 Communication Systems

Connections between IP and TDM phones/trunks are "gateway connections"; each gateway connection requires one DSP (Digital Signal Processor) channel. In addition, DSP channels are required on activating the Signaling And Payload Encryption (SPE) feature.

No DSP channels are required for pure TDM connections and IP-only connections.



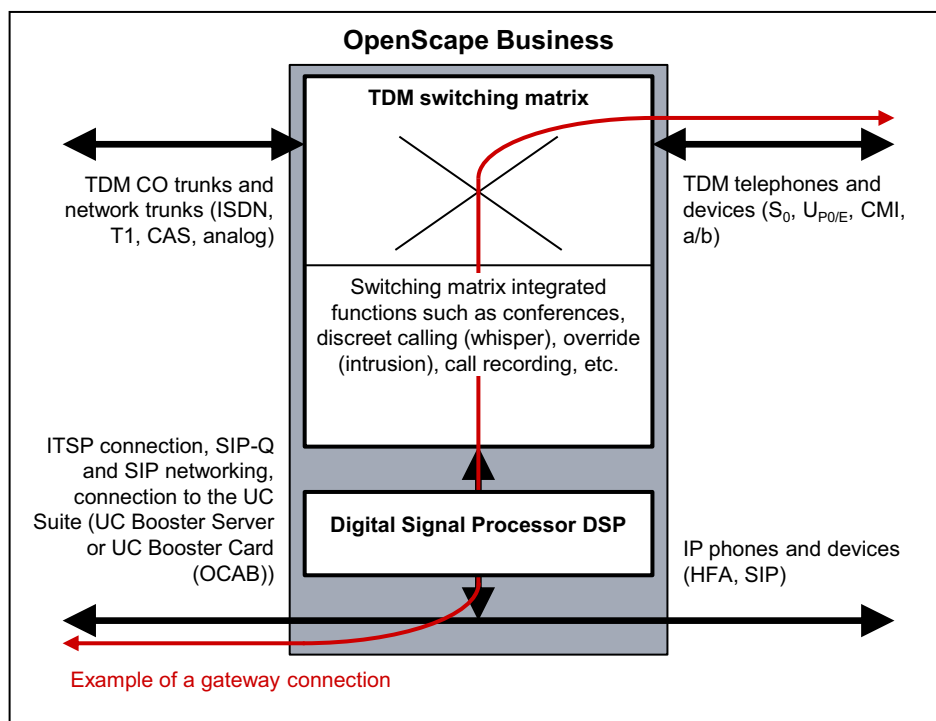

The mainboards of the OpenScape Business X3/X5/X8 communication systems provide a maximum eight DSP channels.

If the DSP channels of a mainboard are not sufficient, additional channels can be provided by plugging in a Voice Channel Booster Card (OCCB1 or OCCB3 subboard):

- OCCB1 provides up to 40 additional DSP channels.
- OCCB3 provides a maximum of 120 additional DSP channels.

The number of DSP channels available for gateway connections is reduced by the use of the G.729 codec and when using Signaling and Payload Encryption (SPE).

Ultimately, the number of simultaneous gateway connections (simultaneous voice connections with IP-TDM transition) determines whether and which OCCB subboard should be used.

In the case of UC-Suite conferencing and IP Phones, an OpenScape Business X3/X5/X8 communications system can include up to eight DSP channels; one DSP channel is reserved for the Music on Hold channel, while seven DSP channels can be allocated for the IP phones (one DSP channel per IP phone). In addition, one DSP channel is reserved for the configuration of the Signaling and Payload Encryption (SPE). When the available DSP channels are exhausted, the number of DSP channels can be increased with the use of the corresponding OCCB cards (OCCB1 or OCCB3 as stated previously).

**Appendix**

Project Planning of DSP Channels for the OpenScope Business X3/X5/X8 Communication Systems

---

**INFO:** For more details on the maximum DSP channels available on the mainboard and the OCCB subboards, see [System-Specific Capacity Limits](#).

---

The undersizing of DSP channels can result in DSP bottlenecks that typically manifest themselves through busy states when setting up connections (busy tone during call setup, display showing `Not currently possible`).

When a DSP bottleneck occurs, an entry is made in the event log file of the communication system.

The following measures should be taken if DSP bottlenecks frequently occur:

If	Then
The DSP channels on the mainboard are being used.	Insert the OCCB1 or OCCB3 subboard into the mainboard.
The DSP channels on the mainboard and the OCCB1 subboard are being used.	Insert the OCCB3 subboard into the mainboard.
The DSP channels on the mainboard and the OCCB3 subboard are being used.	Check whether the communication system can be operated only with the G.711 codec. This increases the number of DSP channels to the maximum.  <b>INFO:</b> The <b>Use G.711 only</b> option can be activated by an administrator with the <b>Expert</b> profile in <b>Expert Mode (Telephony &gt; Voice Gateway &gt; Codec Parameters)</b> .

The following table provides orientation values for which OCCB subboard, if any, should be used.

Sum of the TDM channels: CO trunks and network trunks (ISDN, T1, CAS, analog)	Sum of IP channels: ITSP connection, SIP-Q and SIP networking, connection to the UC Suite (UC Booster Server or UC Booster Card (OCAB))	Sum of TDM telephones and TDM devices (S <sub>0</sub> , U <sub>P0/E</sub> , CMI, a/b)	Sum of IP phones and devices (HFA, SIP)	Which OCCB subboard?	Notes
Any number	Announcements (up to 16) 0	Any number	0	No OCCB subboard	Smart VM and system conferences are processed through the switching matrix.
			up to 8	No OCCB subboard	Independent of the TDM channels  Smart VM and system conferences in combination with IP phones and IP devices require DSP resources.
			9 to 100	OCCB1	Ditto, up to 40 simultaneously
			> 100	OCCB3	Ditto, up to 120 simultaneously
	> 0	up to 8		No OCCB subboard	
	> 0	9 to 100		OCCB1	Up to 40 simultaneously
	> 0	> 100		OCCB3	Up to 120 simultaneously
> 0	up to 8			No OCCB subboard	The combination is essentially relevant for SIP-Q and UC Suite.
> 0	up to 9			OCCB1	Ditto
> 0	> 40			OCCB3	Ditto

The following examples provide orientation values for which OCCB subboard, if any, should be used.

**Example 1: OpenScope Business with TDM Trunks and IP Phones and Devices**

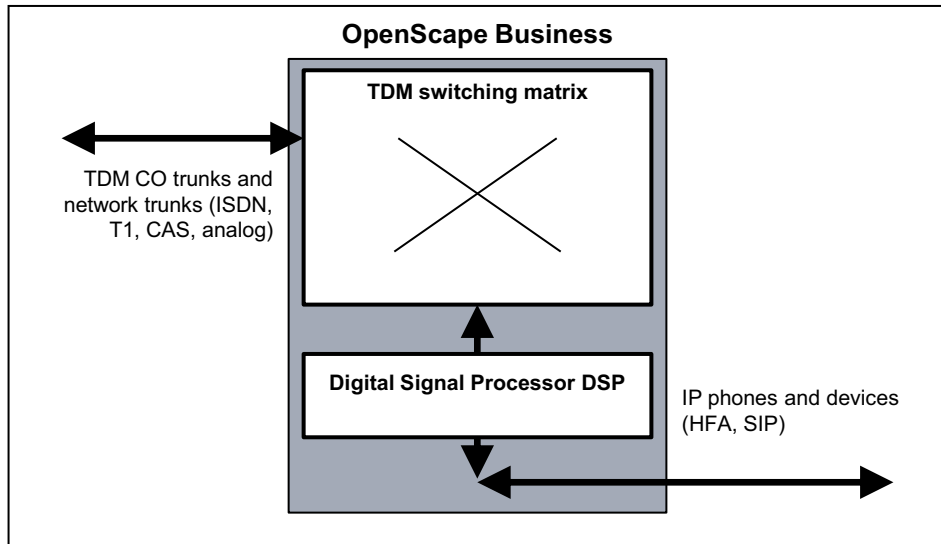

If	Then
OpenScope Business with: <ul style="list-style-type: none"> <li>• 1 x TDM-CO (ISDN)</li> <li>• 20 x IP telephones (HFA, SIP)</li> </ul>	The DSP channels on the mainboard are sufficient. No OCCB subboard is required.
OpenScope Business with: <ul style="list-style-type: none"> <li>• 1 x TDM-CO (ISDN)</li> <li>• 100 x IP telephones (HFA, SIP)</li> </ul>	Subboard OCCB1 is required. Alternatively, the OCCB3 subboard can be used.
OpenScope Business with: <ul style="list-style-type: none"> <li>• 2 x TDM-CO (ISDN)</li> <li>• 100 x IP telephones (HFA, SIP)</li> </ul>	Subboard OCCB3 is required.
OpenScope Business with: <ul style="list-style-type: none"> <li>• 4 x TDM-CO (ISDN)</li> <li>• 500 x IP telephones (HFA, SIP)</li> </ul>	Subboard OCCB3 is required. <b>NOTE:</b> In order to achieve the maximum number of DSP channels, only the G.711 codec may be used in this system configuration.

If the communication system is to be equipped with TDM phones and devices as well ( $S_0$ ,  $U_{P0/E}$ , CMI, a/b), additional DSP channels for this must be taken into account.

**Example 2: OpenScope Business with ITSP Connections and TDM Phones and Devices**

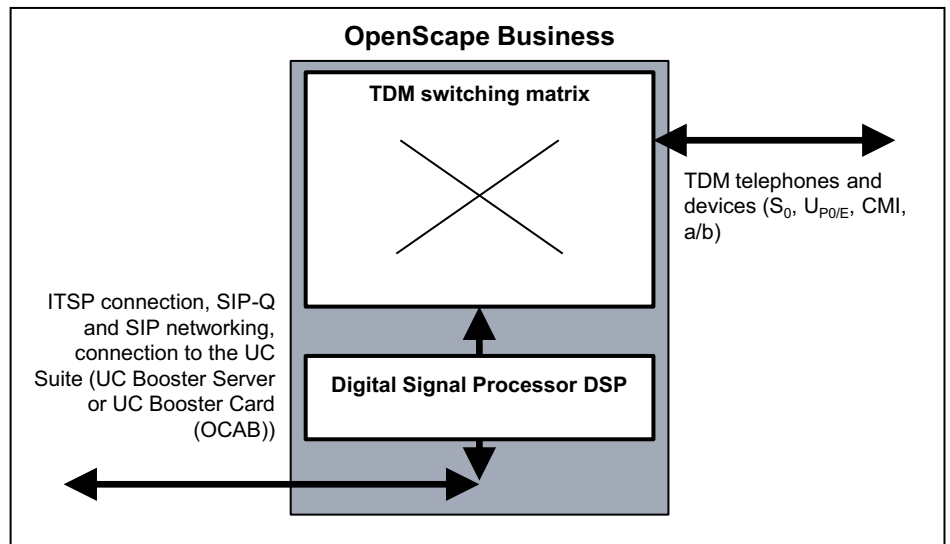

If	Then
OpenScope Business with: <ul style="list-style-type: none"> <li>• 6 x ITSP connections (6 B channels)</li> <li>• 20 x TDM telephones (S<sub>0</sub>, U<sub>P0/E</sub>, CMI, a/b)</li> </ul>	The DSP channels on the mainboard are sufficient. No OCCB subboard is required.
OpenScope Business with: <ul style="list-style-type: none"> <li>• 30 x ITSP connections (30 B channels)</li> <li>• 100 x TDM telephones (S<sub>0</sub>, U<sub>P0/E</sub>, CMI, a/b)</li> </ul>	Subboard OCCB1 is required. Alternatively, the OCCB3 subboard can be used.

If the communication system is to be equipped with IP phones and devices as well (HFA, SIP), additional DSP channels for this must be taken into account.

**Example 3: OpenScape Business with TDM Phones and Devices and IP Phones and Devices**

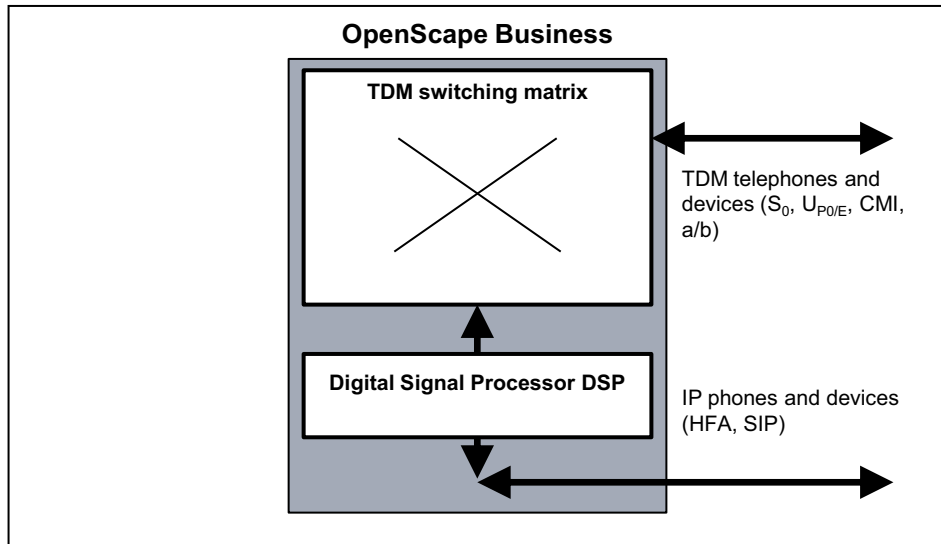

If	Then
OpenScape Business with: <ul style="list-style-type: none"> <li>• 6 x TDM telephones (S<sub>0</sub>, U<sub>P0/E</sub>, CMI, a/b)</li> <li>• 6 x IP telephones (HFA, SIP)</li> </ul>	The DSP channels on the mainboard are sufficient. No OCCB subboard is required.
OpenScape Business with: <ul style="list-style-type: none"> <li>• 100 x TDM telephones (S<sub>0</sub>, U<sub>P0/E</sub>, CMI, a/b)</li> <li>• 100 x IP telephones (HFA, SIP)</li> </ul>	Subboard OCCB3 is required.

If the communication system is to be equipped with TDM trunks or IP trunks as well, additional DSP channels for this must be taken into account.

**Example 4: SIP-Q Networking with OpenScape Business**

The OpenScape Business 1 communication system acts as a gateway for TDM Central Office.

IP phones (HFA, SIP) are connected only to the OpenScape Business 2 communication system.

Depending on the number of IP phones at the OpenScape Business 2 communication system, the DSP channels for the OpenScape Business 1 communication system must be planned. DSP channels are required exclusively in the TDM gateway.

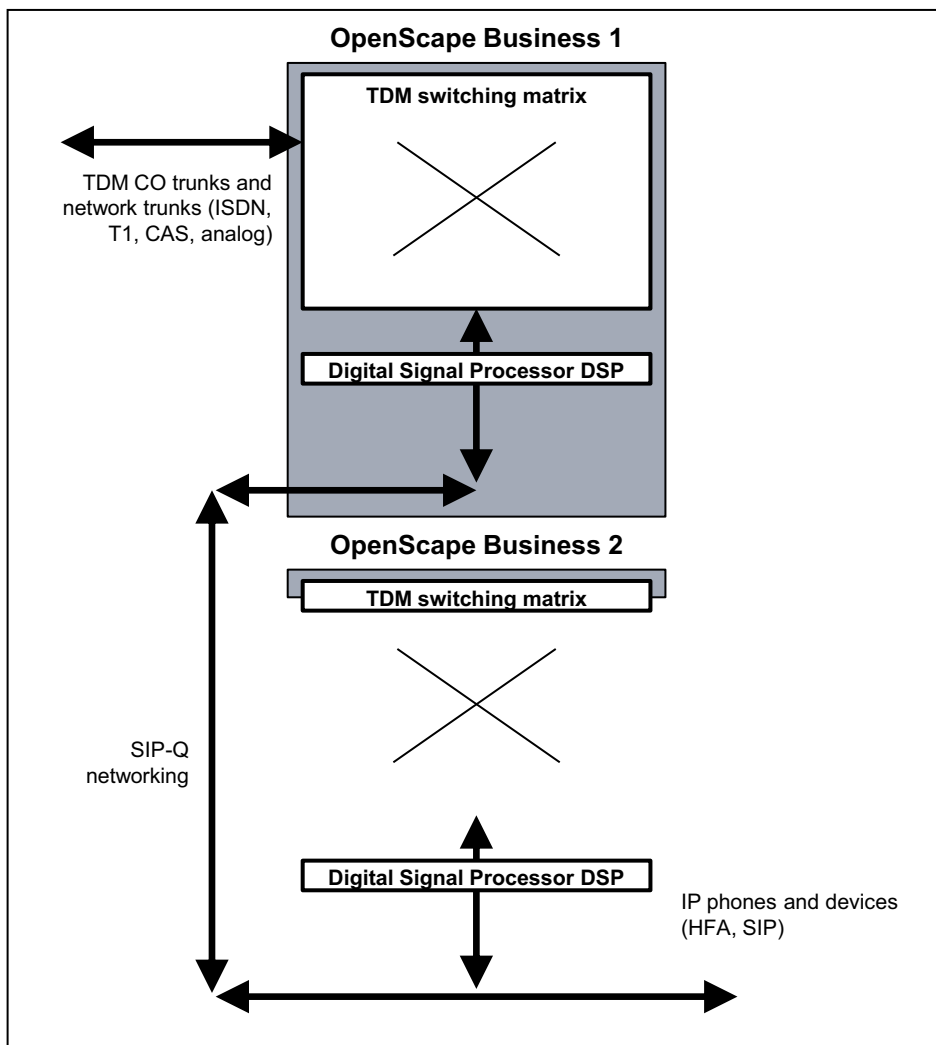

**Appendix**

Project Planning of DSP Channels for the OpenScape Business X3/X5/X8 Communication Systems

If	Then
OpenScape Business 1 with: <ul style="list-style-type: none"> <li>• 1 x TDM-CO (ISDN)</li> </ul> OpenScape Business 2 with: <ul style="list-style-type: none"> <li>• 100 x IP telephones (HFA, SIP)</li> </ul>	Subboard OCCB1 is required in OpenScape Business 1.  Alternatively, the OCCB3 subboard can be used.  No OCCB subboard is required in OpenScape Business 2.
OpenScape Business 1 with: <ul style="list-style-type: none"> <li>• 2 x TDM-CO (ISDN)</li> </ul> OpenScape Business 2 with: <ul style="list-style-type: none"> <li>• 100 x IP telephones (HFA, SIP)</li> </ul>	Subboard OCCB3 is required in OpenScape Business 1.  No OCCB subboard is required in OpenScape Business 2.
OpenScape Business 1 with: <ul style="list-style-type: none"> <li>• 4 x TDM-CO (ISDN)</li> </ul> OpenScape Business 2 with: <ul style="list-style-type: none"> <li>• 500 x IP telephones (HFA, SIP)</li> </ul>	Subboard OCCB3 is required in OpenScape Business 1.  <b>NOTE:</b> In order to achieve the maximum number of DSP channels, only the G.711 codec may be used in this system configuration.  No OCCB subboard is required in OpenScape Business 2.

If the OpenScape Business 2 communication system is to be equipped with TDM trunks or TDM phones and devices (S<sub>0</sub>, U<sub>P0/E</sub>, CMI, a/b) as well, additional DSP channels must be taken into account for this.

**Example 5: SIP-Q Networking with OpenScape Business**

The OpenScape Business 1 communication system acts as a gateway for TDM Central Office.

TDM phones (S<sub>0</sub>, U<sub>P0/E</sub>, CMI, a / b) are connected only at the OpenScape Business 2 communication system.

Since gateway connections are required in both communication systems (OpenScape Business 1: TDM CO <-> SIP-Q Networking, OpenScape Business 2: SIP-Q Networking <-> TDM phone), DSP channels are needed in both systems.



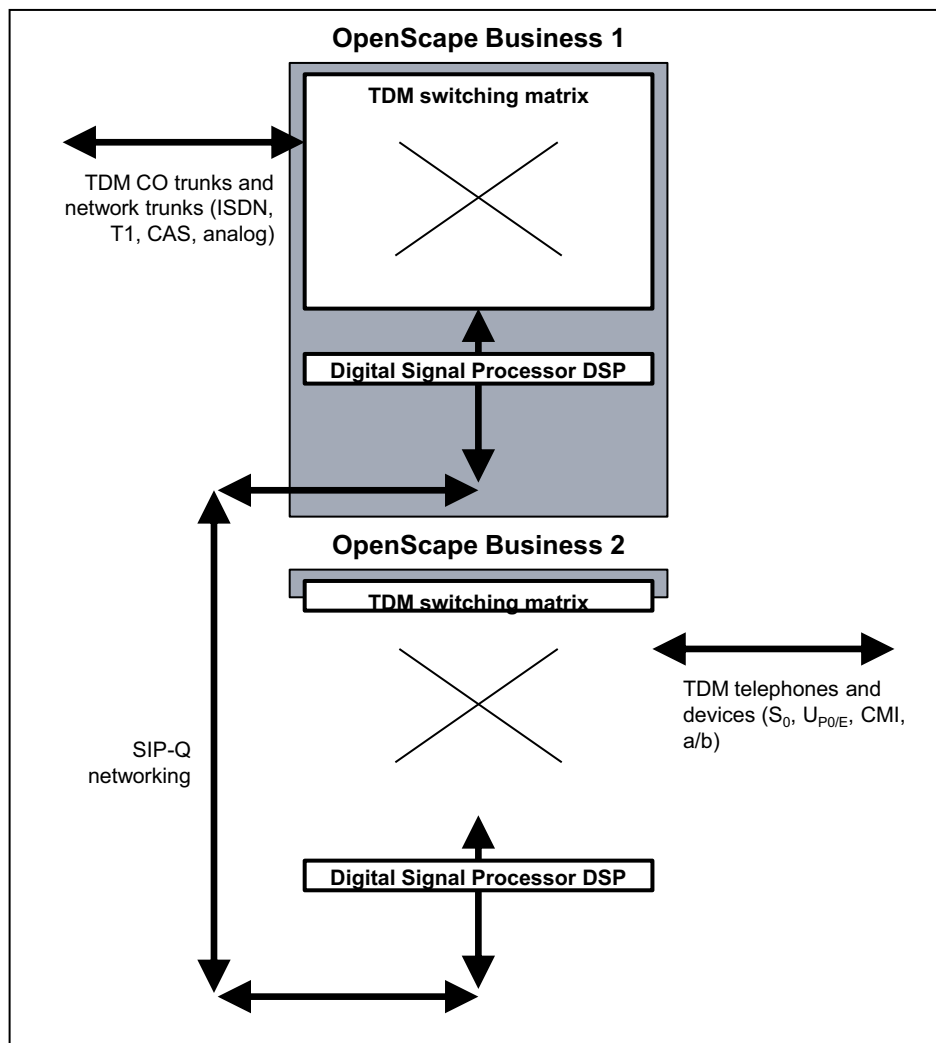

If	Then
OpenScape Business 1 with: <ul style="list-style-type: none"> <li>• 1 x TDM-CO (ISDN)</li> </ul> OpenScape Business 2 with: <ul style="list-style-type: none"> <li>• 100 x TDM telephones (S<sub>0</sub>, U<sub>P0/E</sub>, CMI, a/b)</li> </ul>	Subboard OCCB1 is required in OpenScape Business 1 and OpenScape Business 2.  Alternatively, the OCCB3 subboard can be used in both cases.
OpenScape Business 1 with: <ul style="list-style-type: none"> <li>• 2 x TDM-CO (ISDN)</li> </ul> OpenScape Business 2 with: <ul style="list-style-type: none"> <li>• 100 x TDM telephones (S<sub>0</sub>, U<sub>P0/E</sub>, CMI, a/b)</li> </ul>	Subboard OCCB3 is required in OpenScape Business 1 and OpenScape Business 2.

If the OpenScape Business 1 communication system is to be equipped with TDM phones and devices (S<sub>0</sub>, U<sub>P0/E</sub>, CMI, a/b) as well, additional DSP channels must be taken into account for this.

**Appendix**

## Project Planning of DSP Channels for the OpenScape Business X3/X5/X8 Communication Systems

**Example 6 OpenScape Business with IP Phones and Devices**

<b>If</b>	<b>Then</b>
OpenScape Business X3/X5/X8 with: <ul style="list-style-type: none"><li>• 7 x IP telephones (HFA, SIP)</li></ul>	The DSP channels on the mainboard are s subboard is required.
OpenScape Business: <ul style="list-style-type: none"><li>• 30 x IP telephones (HFA, SIP)</li></ul>	Subboard OCCB1 is required. Alternatively subboard can be used.
OpenScape Business with: <ul style="list-style-type: none"><li>• 100 x IP telephones (HFA, SIP)</li></ul>	Subboard OCCB3 is required.

## 29 Glossary

The glossary provides short explanations of the terms used (for instance, protocols and standards).

### 29.1 Glossary

#### **10BaseT, 100BaseT, 1000BaseT**

This refers to a specification (IEEE. 802.3i) for networks with 10 Mbps base band transmission over a symmetrical 100-Ohm four-wire cable. 100BaseT, on the other hand, is used for bandwidths of up to 100 Mbps and 1000BaseT for bandwidths of up to 1000 Mbps.

#### **AES (Advanced Encryption Standard)**

AES is a symmetric encryption system that was ratified by the National Institute of Standards and Technology as the successor to the earlier DES and 3DES Standards. It is used for VPN, for example.

#### **ADSL with dynamic IP address**

ADSL stands for Asymmetric Digital Subscriber Line and means that the bandwidths from the Internet (download, downstream) and to the Internet (upload, upstream) are different. The classic Internet telephony connection is ADSL. A dynamic IP address is sufficient if the web and mail services are provided by the Internet Service Provider.

#### **ADSL with fixed IP address**

ADSL stands for Asymmetric Digital Subscriber Line and means that the bandwidths from the Internet (download, downstream) and to the Internet (upload, upstream) are different. The classic Internet telephony connection is ADSL. ADSL with a fixed IP address is required if you want to run your own web and mail server on your site.

#### **AF-EF (Expedited Forwarding - Assured Forwarding)**

The codepoints AF and EF define the various priorities of IP packets for QOS (Quality of Service).

AF: guarantees minimum bandwidth for the data

EF: guarantees constant bandwidth for this data.

#### **ARP (Address Resolution Protocol)**

The Address Resolution Protocol (ARP) is a network protocol that facilitates the assignment of network addresses to hardware addresses. Although it is not limited to Ethernet and IP protocols, it is almost exclusively used in conjunction with IP addressing in Ethernet networks.

### **Authentication**

Authentication is the verification of a person's or PC's identity. The check can be performed with a simple user name, for example, as well as with a fingerprint.

### **Authorization**

Authorization is a mechanism for granting rights, e.g., access rights in a data network.

### **B channel**

A B channel is the transmission path for the payload (voice, data) of an ISDN connection.

### **Busy Lamp Field (BLF)**

myPortal provides a so-called Busy Lamp Field (BLF) to display the call status of the specified subscribers.

### **Broadcast**

A broadcast is a message sent to everyone in a PC network. The message (i.e., a data packet) is transmitted from one point to all subscribers in the network. A broadcast is mainly used in a data network if the address of the message recipient is unknown.

### **CA (Certification Authority)**

The CA is an organization that issues certificates with digital signatures. Digital signatures are required for a VPN (Virtual Private Network), for example.

### **CAPI Interface (Common Application Programming Interface)**

CAPI is an ISDN-compliant standardized software interface. CAPI enables the development of ISDN software without requiring any knowledge about the manufacturer-specific ISDN hardware being used.

### **Centrex**

Centrex (Central Office Exchange) provides the functions of a telephone system via a PSTN or ITSP. This is also known as virtual telephone system, hosted PBX (Private Branch Exchange) or NetPBX.

### **CHAP (Challenge Handshake Authentication Protocol)**

CHAP is an authentication protocol used within the framework of the Point-to-Point protocol.

### **COS (Classes Of Service)**

QoS is a procedure that ensures the transmission quality for data in IP networks.

### **CLIP (Calling Line Identification Presentation)**

With station number transmission, the caller's phone number is displayed on the called party's station. The called party can therefore identify the caller before picking up the call.

### **CLIR (Calling Line Identification Restriction)**

The caller suppresses the display of his or her call number on the called station. As a result, the called party cannot identify the caller before picking up the call.

### **COLP (Connected Line Identification Presentation)**

With Connected Line Identification Presentation, the called party's number is displayed for the caller if the connection is successful.

### **COLR (Connected Line Identification Restriction)**

With Connected Line Identification Restriction, the called party's number is not displayed for the caller, even if the caller activated COLP.

### **Comfort User**

Comfort User is the standard user of the communication system.

### **Comfort Plus User**

The Comfort Plus User is the Advanced User of the communication system. In contrast to the Comfort User, the Comfort Plus User can use more features (such as Fax, Mobility and Conferencing).

### **CorNet**

CorNet is a proprietary protocol for networking the HiPath and OpenScape communications systems. In contrast to the generally supported QSIG, all manufacturer-specific features of the HiPath and OpenScape communication systems are integrated in CorNet.

### **CorNet-IP**

CorNet-IP is a protocol variant of CorNet that enables the cross-networking of systems or the connection of system telephones (such as optiPoint) over IP.

### **CorNet-NQ**

A proprietary QSIG-based signaling protocol for interconnecting communication systems to one or more QSIG PBX systems.

### **CSTA (Computer Supported Telecommunications Applications)**

CSTA is a protocol interface for applications that support the European Computer Manufacturers' Association (ECMA) standard. Telecommunication tasks are controlled and monitored using SIP via CSTA.

### **CSV (Character Separated Values)**

A CSV file is a text file for saving or exchanging simply structured data. CSV stands for Character Separated Values, Comma Separated Values or Colon Separated Values, since the individual values are delimited by a special separator character such as a comma or semicolon. CSV files must be available in ANSI/ASCII format.

### **CRL (Certificate Revocation List)**

A CRL or Certificate Revocation List is a list of all revoked certificates. CRLs always have to be generated by the certification authority where the certificates originate.

### **Delay**

A delay has two meanings in telecommunications:

- The delay by which an event is postponed.
- The time between the occurrence of an event and the appearance of a expected follow-on event.

### **Dedicated (Permanently Assigned) Gateway**

If a dedicated gateway is entered in the LCR for a route, then routing via this gateway is enforced. All contradictory rules are then invalid for the routing.

### **DHCP (Dynamic Host Configuration Protocol)**

DHCP is a procedure by which a PC is assigned a certain IP configuration (IP address, subnet mask, etc.) at startup.

### **DS (DiffServ, Differentiated Services)**

DS is a procedure for managing packets in data networks. The routing method for a specific data packet is specified as is a particular service level in regard to bandwidth, queuing theory, and packet discard decisions.

### **Diffie-Hellman algorithm**

The Diffie-Hellman algorithm is used for the exchange of keys in a VPN. The data produced by this algorithm is configured with a specific set of mathematical parameters. The key exchange only works properly if both subscribers use identical values for these parameters.

### **DLI (Deployment License Service Integrated)**

DLI enables the unattended installation and upgrading of IP system telephones.

### **DMZ (Demilitarized Zone)**

A demilitarized zone (DMZ) refers to a PC network that offers a number of security features for accessing connected network nodes (PCs, routers, etc.).

### **DNS (Domain Name Service)**

Name resolution on the Internet and in the LAN. DNS translates the names of PCs or web pages into the relevant IP addresses.

### **DSL (Digital Subscriber Line)**

DSL is a technological solution for providing high-bandwidth Internet access. Internet telephone bridges the gap between the provider's attendant and the customer's telephone jack.

### **DSS (Direct Station Selection)**

The function keys on a telephone or add-on device can be programmed as Direct Station Select (DSS) keys. These are programmed with the phone number of an internal subscriber or a group for this. Pressing a DSS key initiates an immediate call to the programmed destination.

### **DTMF (Dual Tone Multifrequency)**

See DTMF.

### **EIM (Enterprise Instant Messaging)**

EIM is an Instant Messaging Service that runs on private servers in a company on platforms such as the Live Communications Server or Office Communications Server 2007 from Microsoft.

### **Enterasys Switches**

Enterasys switches are produced by Enterasys Networks as secure network solutions. The stackable switches support QoS features and can classify and prioritize voice, video and data applications.

### **ESP (Encapsulating Security Payload)**

ESP is an IPsec protocol that guarantees packet encryption, packet integrity as well as packet authenticity. The integrity and authentication check does not extend to the IP header. It is only performed for the actual data (payload).

### **FoIP (Fax over IP)**

FoIP is a method for transmitting fax messages over an IP network.

### **FTP**

The File Transfer Protocol (FTP) is a network protocol specified in RFC 959 for the transmission of data via TCP/IP networks.

### **Functional Numbers**

Functional numbers (also called function codes) are MSN/DID numbers or pilot numbers, e.g., for parking, conferencing and the AutoAttendant. The functional numbers correspond to virtual stations. The functional numbers in an internetwork must be unique.

### **G.711**

G.711 is a standard for digitizing analog audio signals. It is used in classic fixed-network telephony (PCM technology). G.711 can also be used for voice encoding in VoIP.

### **G.729AB**

G.729 is a codec for voice compression in digital signals and is used in IP telephony. G.729 is very CPU-intensive. Though only marginally inferior in terms of quality, G.729AB is a somewhat simplified version and therefore less CPU-intensive.

### **Gateway / Gateway Modules**

A gateway is the entrance and exit to a communications network, usually connecting two disparate traffic flows.

### **GSM (Global System for Mobile Communications)**

GSM is a standard for digital mobile networks that is primarily used for telephony, but also for line- and packet-switched data transmissions as well as short messages (SMS).

### **Handover**

The term handover designates the process in a mobile cellular communication network in which the mobile phone switches from one cell to another during a call or a data connection. The term is also used when switching between GSM and UMTS with a dual-mode mobile phone.

### **Hash value**

Hash or dispersion range values are usually scalable values from a subset of natural numbers. A hash value is also referred to as a "fingerprint" because it is a virtually unique identification of a quantity in much the same way as a fingerprint is a virtually unique identification of a person.

### **H.323**

H.323 designates a group of standards that define a variety of media types for packet networks. The standards cover voice, data, fax and video, and define how signals are to be converted from analog to digital and what signaling is to be used.

### **OpenScape Business Assistant**

OpenScape Business Assistant is used to administer the communication system. It provides all wizards for the quick support of administration tasks.

### **Hosted Services**

Hosted Services are traditional IT services such as e-mail, instant messaging (IM) and unified communications (UC), which are provided to a company by an Internet Provider from a remote site, thus eliminating the company's need to run and manage these services on their own servers on-site.



### **ICMP (Internet Control Message Protocol)**

ICMP is used in data networks for the exchange of information and error messages using the Internet Protocol IP.

### **IDS (Intrusion Detection System)**

IDS is a security system that monitors all incoming and outgoing network activities to identify possible security violations. These include both intrusion (attacks from outside the organization) and abuse (attacks from within the organization).

### **IEEE Standards**

IEEE Standards are a set of specifications defined by the Institute of Electrical and Electronic Engineers (IEEE) (such as Token Ring, Ethernet) to establish common networking standards among vendors.

### **IEEE. 802.1p**

IEEE. 802.1p is an IEEE standard for regulating the transport of data packets with different priorities in computer networks. The data packets are classified into priority classes from 1 to 7. The Standard only stipulates ascending priorities from 1 through 7, but does not deal with how the individual data packets should be handled.

### **IKE Protocol**

The IKE protocol has two different tasks. Start by creating an SA (Security Association) exclusively used by the IKE protocol (IKE-SA). The existing IKE-SA is then used for secure negotiation of all further SAs (payload SA) for the transmission of payload data.

### **IM (Instant Messaging)**

IM is a procedure for the real-time exchange of text messages over the Internet using computers, Pocket PCs and mobile phones. Modern IM services enable VoIP and video conferencing, file transfers and desktop application sharing.

### **IP PBX**

IP PBX is a communication system that supports both VoIP and normal voice connections over traditional phone lines.

### **IPSec**

IPSec is a framework of open standards for ensuring private, secure communications over Internet Protocol (IP) networks through the use of various security services and protocols.

### **ISP (Internet Service Provider)**

An ISP is a business that supplies Internet connectivity services to individuals, businesses, and other organizations. Some ISPs are large national or multinational corporations that offer access in many locations, while others are limited to a single city or region.

**ITSP (Internet Telephony Service Provider)**

An ITSP is a business that supplies Internet connectivity services to individuals, businesses, and other organizations.

**DP (Dial Pulsing)**

DP is the oldest signaling method used for automatic telephone switching. Today, DP has generally been superseded by DTMF.

**Jitter**

Jitter refers to packet delay variations in voice transmissions. An excessive delay between the sending of packets and their arrival at the receiving end results in irregular voice communications in which words are difficult to understand.

**ISD (Individual Speed Dialing)**

Individual Speed Dialing (ISD) enables 10 external individual speed-dial numbers to be saved at every authorized phone in addition to the system speed dialing (SSD).

**SSD - System Speed Dialing**

Frequently required external phone numbers can be stored in the system memory of the communication system. Every number is represented by a speed-dial number, which can be used instead of the full phone number by all stations.

**Latency**

Latency is the time required to transport a data packet from one application to another, including the time for transmission over the network and for preparing and processing the data at the transmitting and receiving devices.

**LCR (Least Cost Routing)**

You can use the Least Cost Routing (LCR) function to specify the provider you want to use, e.g., for trunk calls, mobile phone calls or international calls. You use the communication system to define the least-cost provider and conduct all calls via this specific path.

**LIN (Location Identification Number)**

LIN is a unique, max. 16-digit number that corresponds to the 10-digit NANP (North American Numbering Plan).

**LWCA (Lightweight CA)**

LWCA is a restricted certification function.

**Media Stream Channel**

A media gateway can terminate circuit-switched ISDN B channels and use the voice data carried to generate media stream channels for an IP-based packet-switched network. Media stream channels feature a combination of audio, video, and T.120 media.

### **DTMF (Dual Tone Multifrequency)**

Dual Tone Multifrequency (DTMF) is the dialing method in analog telephony that is predominantly used in switching technology today for transmitting the phone number to the telephone network.

### **MIM (Mobile Instant Messaging)**

MIM is a Presence and Instant Messaging Service for mobile phones.

### **Mobility**

The term mobility designates the use of Pocket PCs and mobile phones and their integration in the communication system of a company.

### **MOH (Music on Hold)**

Music on Hold (MOH) can be played to callers who cannot be switched through immediately.

### **MSN (Multiple Subscriber Number)**

When connecting ISDN phones via an S0 bus (point-to-multipoint connections), every single ISDN phone (ISDN station) is assigned a unique Multiple Subscriber Number (MSN). The ISDN stations can be reached via their MSNs.

### **MULAP (Multiple Line Appearance)**

MULAPs are special groups in which multiple telephones are combined. A group member may be assigned multiple phones under a single call number (Basic MULAP) here. In addition, such a group can be used to implement special features required for communication between an Executive and Secretary, for example, or within teams (Executive MULAP, Team MULAP).

### **Multi-Gateway**

In the case of a multi-gateway network, calls are routed via several different gateways.

### **myAttendant**

myAttendant is the attendant console of the communication system.

### **myPortal**

myPortal is the Java-based user portal that enables subscribers to access the Unified Communications functions. Apart from information on the presence status, convenient dialing aid via favorites and directories, subscribers can also access voicemail messages and faxes.

### **myPortal for Outlook**

myPortal for Outlook is the user portal integrated in Microsoft Outlook that enables subscribers to access unified communications functions. It is analogous to myPortal. myPortal for Outlook also provides a convenient Desktop Dialer.

**NAC (Network Admission Control)**

NAC is a technology that supports defenses against viruses and worms from within the network. With NAC, terminal devices are checked for conformity with guidelines during the authentication. If the virus scanner is not up-to-date, for example, or if the client operating system does not have the latest security patch installed, the device involved is quarantined and provided with the current updates until it meets the applicable security guidelines.

**NAT (Network Address Translation)**

NAT is a procedure for replacing one IP address in a data packet with another. It is used to map private IP addresses to public IP addresses. Masking or PAT (Port Address Translation) is when the port numbers are also rewritten.

**NTBA (Network Termination for ISDN Basic Access )**

An NTBA (Network Termination for ISDN Basic Access), also known as NT (Network Termination), is the network termination device for the ISDN basic rate interface. It is the link between the network operator's digital network and the ISDN configurations on the subscriber side.

**NTPM (Network Termination for Primary Rate Multiplex Access)**

An NTPM (Network Termination for Primary Rate Multiplex Access) is the network termination device for the ISDN primary rate interface. It is the link between the network operator's digital network and the ISDN configurations on the subscriber side.

**OLSR - Optimized Link State Routing Protocol**

OLSR is special ad-hoc protocol that enables the missing routing capability on the OSI Layer 2 to be optimized on the OSI Layer 3.

**ONS (One Number Service)**

Call number directly assigned to a user One or more resources (telephones) may be assigned to a user. When a user is called via his or her ONS number, the call is forwarded to the phone that is currently being used by that user (e.g., a mobile phone).

**PAP (Password Authentication Protocol)**

PAP is an authentication procedure based on the point-to-point protocol. It is used for dialing into an ISP. PAP transmits the password for authentication as clear text together with a user ID.

**PBX (Public Branch Exchange)**

A PBX is a switching system that interconnects multiple terminals such as phones, fax and answering machines between themselves and also to the public phone network.

### **Peer**

A peer is the terminal device for communication in a peer-to-peer network. During communication, every peer makes its services available and uses the services of the other peer.

### **Peer-to-peer**

In a peer-to-peer network, all PCs have equal rights and may use and also provide services on the network.

### **Peer-entity authentication**

The corroboration that the peer entity in an association is the one claimed.

### **PKI (Public Key Infrastructure)**

In cryptology, a PKI (public key infrastructure) is a system for generating, distributing, and verifying digital certificates. The certificates issued within a PKI are used to protect computer-driven communication.

### **PPP (Point-to-Point Protocol)**

PPP is an IETF standard for transmitting IP packets over serial lines. PPP is mainly used for dialing into the Internet.

### **PPPoE (Point-to-Point Protocol over Ethernet)**

The PPPoE Protocol (PPP over Ethernet) enables the use of the Point-to-Point network protocol over an Ethernet connection.

### **Pre-shared Key**

The pre-shared key is a key that is defined for the tunnel configuration (for VPNs). In order for VPN peers communicating via the tunnel to authenticate themselves, the same password must be used for both of the tunnel endpoints.

### **PPTP (Point-to-Point Tunneling Protocol)**

PPTP is a technology used for configuring a virtual private network (VPN). Because the Internet is essentially an open network, PPTP is used to ensure that messages transmitted from one VPN node to another are secure. PPTP lets users dial into their corporate network via the Internet.

### **Presence**

The term Presence refers to the capability of a Unified Communications system to determine the location and status of a user at any time. This makes it easier to respond to the specific communication needs of a user by phone, e-mail, Instant Messaging or fax.

### **Proxy Server**

The proxy server is the connecting link between a client application and a Web server. It performs the task of filtering client application requests and thus relieves the load on the Web server.

**PSTN (Public Switched Telephone Network)**

As the name implies, PSTN refers to a public switched telephone network. Public networks may be owned by private or public entities.

**QoS (Quality of Service )**

You must guarantee a minimum bandwidth for Voice over IP for the entire transmission duration. If multiple applications with equal rights are operating via IP, then the available bandwidth for a transmission path is split. In this case, a voice connection may experience packet losses which can reduce voice quality. There are different ways to guarantee the highest possible quality for transmission; these methods are collectively referred to as Quality of Service (QoS).

**RAS (Remote Access Service)**

A RAS (Remote Access Service) user is an IP subscriber (e.g., a teleworker) who logs into the system remotely and behaves like an internal IP station. This subscriber can therefore use the complete functional scope of the communication system.

**RJ45 (Registered Jack 45)**

RJ45 is an eight-pin connector that is used for connecting a 10BaseT cable in network technology, for example.

**Roaming**

Roaming is the capability of a mobile network subscriber to automatically make calls or access other mobile network services in a foreign network, i.e., one that differs from the home network of the subscriber.

**RTCP (Real-Time Control Protocol)**

The real time control protocol (RTCP) is used for the negotiation and compliance of Quality of Service (QoS) parameters through the periodic exchange of control messages between senders and receivers.

**RTP (Real-Time Transport Protocol)**

RTP is an IETF Standard for streaming real-time multimedia data using the Internet Protocol. Typically, RTP runs on top of the UDP protocol, and uses dynamic UDP ports negotiated between the sender and receiver of specific media streams.

**RTT (Round Trip Time)**

RTT is the time interval required by a data packet to move from the source to the target and back.

**SA (Security Association)**

SA is a security association between two communicating units in computer networks. It describes how the two parties will use security services to communicate securely with each other.

### **SDSL (Symmetric Digital Subscriber Line)**

SDSL is particularly suited to Internet telephony, intranet applications in companies with local networks, for video conferencing and is, for example, designed for teleworkers who can use it to send and receive data with the same bandwidth. In contrast to ADSL, SDSL uses identical bandwidths from and to the Internet.

### **Secure CLI**

Secure CLI is a security feature that provides secure command line and data transfer interfaces with the help of the Secure File Transfer Protocol (SFTP).

### **SFTP (Secure File Transfer Protocol)**

SFTP is a security protocol for transporting connection data records.

### **ShrewSoft VPN Client**

The ShrewSoft VPN client is an open source and free VPN client with a graphical user interface. It includes, among other things, ISAKMP, Xauth and RSA support, and AES, Blowfish and 3DES encryption protocols.

### **Single Gateway**

In the case of a single-gateway network, calls are routed via a single gateway.

### **SIP (Session Initiation Protocol)**

SIP is a standard Internet protocol defined in RFC 3261 for setting up and managing voice connections and video conferences over an IP network.

### **SNMP (Simple Network Management Protocol)**

SNMP is a procedure for obtaining information on the status of network components and PCs.

### **SPE (Signaling and Payload Encryption)**

Signaling & Payload Encryption (SPE) serves to enhance security when transmitting voice data. The VoIP payload and signaling data streams from and to the gateway and between IP phones are encrypted.

### **SRTP (Secure Real-Time Transport Protocol)**

SRTP is an encrypted RTP protocol. It is particularly suitable for transmitting communication data over the Internet and is used in IP telephony.

### **SSH (Secure Shell)**

SSH is a protocol that provides support for secure remote login, secure file transfer, and secure TCP/IP forwarding. It can automatically encrypt, authenticate, and compress transmitted data.

### **SSL (Secure Socket Layer)**

SSL is a protocol for transporting documents over the Internet. With SSL, data is provided with a private key before it is transmitted. By convention, URLs that require an SSL connection start with https: instead of http:.

### **Status**

The status, together with the "Presence" concept, indicates whether a subscriber is available, busy, offline, etc., so that other subscribers in the communication system know if this subscriber can be reached.

### **STUN (Simple Traversal of UDP through NAT)**

STUN is a network protocol for detecting, identifying, and bypassing firewalls and NAT routers.

### **Survivability**

Survivability is the capability of an internetwork to maintain service continuity in the presence of faults within the network.

### **TAE (Telekommunikations-Anschluss-Einheit) - German standard for telephone plugs and sockets**

A TAE is a type of connector for analog phone connections with the a/b interface and for ISDN connections to plug the NTBA into the main line. It is used to connect analog telephones, fax machines and ISDN phone systems.

### **TCP (Transmission Control Protocol)**

TCP is a protocol that governs how data should be exchanged by PCs. All operating systems in modern PCs support TCP and use it for data exchange with other PCs.

### **TFTP (Trivial File Transfer Protocol)**

TFTP is a trivial file transfer protocol that supports only the reading and writing of files. Many of the functions supported by the superordinate protocol are unavailable, for example, functions allocating rights, displaying existing files or user authentication.

### **Telnet**

A protocol that links two PCs in order to provide a terminal connection to the remote PC. Instead of dialing into the PC, the user connects over the Internet via Telnet. The user initiates a Telnet session, connects to the Telnet host and logs in. The connection enables the user to work with the remote PC as though it were a terminal connected to it.

### **TOS (Type of Service)**

TOS is a field in the header of IP data packets. It is used for the prioritization of these packets and evaluated for Quality of Service, for example.



### **UCD (Uniform Call Distribution)**

UCD enables incoming calls in the communication system to be uniformly distributed to a group of stations (UCD-group).

### **UDP (User Datagram Protocol)**

UDP is a network protocol that belongs to the Transport layer of the Internet protocol family. UDP is responsible for routing data transmitted over the Internet to the correct application.

### **UMTS (Universal Mobile Telecommunications System)**

UMTS is a third-generation mobile network standard with which significantly higher data transmission rates (384 kbps to 7.2 Mbit/sec.) can be achieved as compared to the mobile network standards of the second generation or the GSM standard.

### **Unified Communications**

Unified Communications is the integration of various communication systems, media, devices and applications within an environment (e.g., IP telephony, site-based and mobile telephony, e-mail, instant messaging, desktop applications, voicemail, fax, conferencing and unified messaging).

### **Unified Messaging**

Unified Messaging is the integration of different communication data such as e-mail, SMS, fax, telephony, etc., in a uniform message store. This message store can be accessed by several different devices.

### **VAD (Voice Activity Detection)**

VAD (Voice Activity Detection) is an algorithm in speech processing to detect the presence or absence of speech in the digital transmission of audio data.

### **VCAPI Interface**

VCAPI is a virtual CAPI interface that emulates the presence of a local ISDN card. If an ISDN card has been installed on a PC in the internal network, then this ISDN card can be made available to all stations on the network via the VCAPI interface.

### **VDSL (Very High Speed Digital Subscriber Line)**

VDSL is used to transfer symmetrical or asymmetrical data streams at high speed over short distances. VDSL is an alternative to ADSL and SDSL that additionally offers higher transmission speeds.

### **VoIP (Voice over IP)**

VoIP is the transmission of voice data over IP-based networks.

### **VPN (Virtual Private Network)**

A VPN uses the public infrastructure of the Internet to connect sites and provide teleworkers with access to internal networks. External partners are provided with

secure access to the internal data network by using encryption and authentication mechanisms.

**WAN (Wide Area Network)**

WAN is the designation for wide area data networks such as the Internet, for example.

**WBM (Web-Based Management)**

WBM is a web-based user interface that is displayed in an Internet browser using HTML or JAVA pages (web pages) and a web protocol (HTTP or HTTPS).

**X.509 standard (VPN certificate)**

X.509 is an ITU-T standard for a public key infrastructure and currently the most important standard for digital certificates.

**XMPP (Extensible Messaging and Presence Protocol)**

Internet standard that is primarily used for Instant Messaging. XMPP supports the interaction with users of other networks such as AIM, ICQ or Windows Live Messenger (WLM), for example. Among other things, XMPP and its extensions support conferencing with multiple users (e.g., multi-user chats) and the display of the online status.

**Second Degree**

Second degree means that a station is calling and already has a second call waiting for that station.

# Index

## A

- accidents, reporting 54
- Actions
  - Automatic Actions, Expert mode 1423, 1424
  - Manual Actions, Expert mode 1421
- Actions, Expert mode 1421
- activate licenses 270, 280
- activation, software (see software activation)
- Active Certificates, Expert mode 1468
- Active Rules, Expert mode 1477
- Active Services, Expert mode 1471
- Active Tunnels, Expert mode 1472
- Address Resolution Protocol, Expert mode 1425
- ad-hoc conference 465, 539
- Admin log
  - change language 931, 932, 933
  - load 975
- admin log
  - change language 976
- Admin log (also called admin protocol) 975
- Admin Log Data, Expert mode 1421
- Admin Protocol
  - Admin Log Data, Expert mode 1421
  - Configuration, Expert mode 1421
- Admin Protocol, Expert mode 1421
- advisory messages 608
- AF/EF code points 394
- alarm signaling, Expert mode 1417
- All Leases, Expert mode 1494
- Allowed lists
  - display 697
- Allowed Lists, Expert mode 1579
- alternative workplace 505
- Analog Stations, Expert mode 1525
- analog telephone 405
- announcement player 1623
- announcement player, Expert mode 1458
- Announcements and Music on Hold, Expert mode 1583
- announcements for call distribution 687
- announcements for voicemail 549
- answering machine 405
- Application Diagnostics
  - Developer Settings, Expert mode 1425
  - Mainboard, Expert mode 1425
- Application Diagnostics, Expert mode 1424
- Application Firewall, Expert mode 1461

- Application Launcher 1132, 1623
  - profile for configuration data 1133
- Application Launcher, Expert mode 1622
- Application Selection 1596
- application-controlled conference 465, 534
- Applications, Expert mode 1596, 1623
- appointment 616
- Assign MSN, Expert mode 1576
- audio codec 390
  - assign parameters to a destination 391
  - configure parameters 390
- audio file 1165, 1168
- authentication
  - conference participant 465
- Auto DSP Trace, Expert mode 1414
- AutoAttendant 549
- Autom. night service, Expert mode 1582
- automatic action 1215
  - DLS notification 1217
  - edit DLS notification 1218
  - edit garbage collection 1215
  - garbage collection 1215
  - start DLS notification 1218, 1220
  - start garbage collection 1216
  - stop DLS notification 1219
  - stop garbage collection 1217
- automatic callback 604
- automatic recall 589
- automatic updates 492
- automatic wake-up system 616
- Auxiliary Equipment
  - Announcements/Music On Hold, Expert mode 1583
  - Entrance Telephone (Door Opener), Expert mode 1584
  - SmartVM, Expert mode 1585
- Auxiliary Equipment, Expert mode 1549, 1583

## B

- back up 1175
- backup
  - immediate 1180
  - scheduled 1182
- backup - immediate 1180
- backup directory 1176
- backup medium 1175, 1177
  - add 1178

## Index

- delete 1180
- edit 1179
- backup set 1175, 1176
  - display 1177
  - immediate backup 1180
  - restore 1183
  - scheduled backup 1182
- backup set for diagnostic purposes 1292, 1293
- bandwidths in the LAN 988
- Base stations, Expert mode 1400, 1527, 1553
- Basic MULAP 658
  - add 663
  - add a member 665
  - delete 664
  - delete a member 665
  - display 664
  - edit 664
  - edit a member 665
  - ring type 659
- Basic Settings
  - announcement player, Expert mode 1458
  - Call Charges, Expert mode 1455, 1456, 1457
  - Date and Time, Expert mode 1453
  - DynDNS, Expert mode 1450, 1451
  - Gateway, Expert mode 1449
  - Phone Parameter Deployment, Expert mode 1458
  - Port Management, Expert mode 1454
  - Quality of Service, Expert mode 1452
  - System, Expert mode 1427, 1434, 1439, 1442, 1443, 1445, 1446, 1447, 1448
- basic settings
  - power management, Expert mode 1459
- Basic Settings, Expert mode 1427, 1621
- board status, Expert mode 1402
- boards
  - not supported 1358
- branding, Expert mode 1395
- broadband connection 325
- C**
- cable port 325
- cabling for LAN and WAN connections 56
- call
  - missed 527
  - scheduled 527
- Call Charges - Account Codes, Expert mode 1457
- Call Charges - Factors, Expert mode 1456
- Call Charges - Output Format, Expert mode 1455
- call deflection after timeout 599
- call distribution 676, 677
  - accept UCD calls automatically 683
  - accept UCD calls automatically, activate 683
  - accept UCD calls automatically, deactivate 684
  - add a UCD agent 681
  - AICC (Automatic Incoming Call Connection) 683
  - announcements 687
  - change the overflow 686
  - configuration 677
  - configure 678
  - configure a UCD group 678
  - delete a UCD agent 681
  - edit a queue 685
  - edit announcements 688
  - edit Music On Hold (MOH) 688
  - edit the priority of external calls 683
  - edit the priority of internal calls 683
  - edit the wrapup time 682
  - night service 687
  - overflow 686
  - priority of external calls 682
  - priority of internal calls 682
  - queue 684
  - release UCD calls from analog lines 689
  - release UCD calls from analog lines, edit the release time 689
  - subscriber state 679
  - transfer to UCD group 689
  - transfer to UCD group, edit the recall time 689
  - UCD agent 679
  - UCD group 677
  - wrapup time 681
- call forwarding 597
  - rule-based 506
  - status-based 506
- call forwarding on busy 594
- Call Forwarding, Expert mode 1563
- call forwarding-no answer after timeout 594
- call monitoring, Expert Mode 1408
- call number format 464
- call pickup from voicemail 549
- call pickup group 618
  - activate warning tone 636
  - add member 627
  - call pickup for recalls 618
  - call pickup outside of a call pickup group 618
  - configure 626
  - deactivate warning tone 636
  - delete member 627
  - disable call pickup for recalls 636, 991
  - disable the display of a caller's name 635
  - disable the display of a caller's phone number 635
  - display of a caller's name 618
  - display of a caller's phone number 618
  - enable call pickup for recalls 636, 991

- enable the display of a caller's name 635
- enable the display of a caller's phone number 635
- SIP phones 618
- warning tone 618
- Call Pickup, Expert mode 1560
- call signaling 580
- call waiting tone/call waiting 605
- call waiting/call waiting tone 605
- callback 604
  - journal 527
- callback on busy 605
- Calling Line Identification Presentation - CLIP 581
- Calling Line Identification Restriction - CLIR 582
- CallMe 505
- CallMe service 505
- canonical call number format 464
- capacities 1371
- capacity limits 1371
- Carrier Select Override 709
- CDP (Certificate Distribution Point) 969
- CE Conformity 59
- CE mark 58
- Central License Server (see license server)
- Certificate Generation, Expert mode 1480
- Certificate Management, Expert mode 1467, 1481
- CLA
  - central connection 301
  - local connection 289, 301
- Classes of Service
  - Allowed Lists, Expert mode 1579
  - Autom. night service, Expert mode 1582
  - CON Group Assignment, Expert mode 1580
  - CON Matrix, Expert mode 1581
  - Day
    - Class of Service Groups, Expert mode 1577
  - Denied Lists, Expert mode 1579
  - Night
    - Class of Service Groups, Expert mode 1578
  - Night service, Expert mode 1580
  - Special Days, Expert mode 1582
  - Stations, Expert mode 1577
- Classes Of Service, Expert mode 1508
- Classes of Service, Expert mode 1577
- client (UC Smart) 448
- client (UC Suite) 482
- client logs 1299
  - download 1302
- clients, hardware and software prerequisites 486, 785, 811, 815
- CLIP - Calling Line Identification Presentation 581
- CLIP no screening 584
- clipboard dialer 529
- CLIR - Calling Line Identification Restriction 582
- CMD (CSTA Message Dispatcher) 1623
- Codec Parameters, Expert mode 1511
- collect call barring per trunk 707
- COLP - Connected Line Identification Presentation 583
- COLR - Connected Line Identification Restriction 584
- communication system
  - shut down 1202
- communication system, remote access 1317
- Communities, Expert mode 1419
- compliance
  - US and Canadian standards 60
- CON Group Assignment, Expert mode 1580
- CON groups 703
  - allocation of SSD numbers 704
  - assign codes 705
  - assign subscribers/stations 704
- CON matrix, edit 705
- CON Matrix, Expert mode 1581
- concept 43
- condition
  - rule-based call forwarding 506
- conference 465, 532
  - ad-hoc 539
  - application-controlled 532
  - authentication 532
  - automatic invitation by e-mail 532
  - automatic invitation via Outlook appointment 532
  - conference controller 532
  - conference participants 532
  - conference tone 532
  - dial-in number 532
  - extend 532
  - Mobility Entry stations 532, 539, 540, 542, 543
  - open 543
  - permanent 542
  - phone-controlled 532
  - record 532
  - scheduled 540
  - types 532
  - virtual conference room 532
- conference (UC Suite) 532
- conference management 465, 534
- conference tone, activate/deactivate 598, 599
- conference, phone-controlled 465, 534
- Conferencing, Expert mode 1612
- Configuration
  - Music on Hold (MoH), Expert mode 1390
  - Port Configuration, Expert mode 1391
- configuration
  - announcements, Expert mode 1391
  - branding, Expert mode 1395

## Index

- IP gateway address, Expert mode 1395
- SmartVM, Expert mode 1392, 1393
- configuration data 1175
- configuration data for diagnostics 1292
  - generate 1293
- Configuration, Expert mode 1390, 1421
- configure call forwarding 473, 595
- Configured Certificates, Expert mode 1469
- Configured Rules, Expert mode 1479
- Configured Services, Expert mode 1471
- Configured Tunnels, Expert mode 1474
- conformity
  - international standards 60
- Connected Line Identification Presentation - COLP 583
- Connected Line Identification Restriction - COLR 584
- connection to central CLA 301
- connection to local CLA 289, 301
- contact 527
- Contact Center
  - activate a queue 868
  - add a break 872
  - add a queue 862
  - add a schedule 857
  - agent 818
  - agent callback 833
  - assign agent to queue 877
  - break 820
  - CCV objects 772, 826
  - class of service (authorization level) of an agent 818
  - clients 809
  - conditions for operation 879
  - configuration 838
  - configure a UCD group 855
  - configure stations as agents 855
  - configuring a pilot for incoming Fax messages 868
  - deactivate a queue 868
  - define preferred agents 871
  - define target values for the Grade Of Service 869
  - define the VIP caller priority 870
  - delete a break 873
  - delete a schedule 861
  - delete preferred agents 872
  - display queue details 833
  - edit a break 873
  - edit a queue 866
  - edit a schedule 860
  - edit the VIP call list 870
  - example of a Contact Center configuration 838
  - fallback solution 835
  - Grade of Service 833
  - holiday schedule 772, 826
  - load announcement 857
  - multiple wrapup, add wrapup reason 875
  - multiple wrapup, delete wrapup reason 876
  - multiple wrapup, edit wrapup reason 876
  - myAgent 810
  - myReports 813
  - myReports user roles 813
  - predefined report templates 883
  - preferred agents 819
  - print rule 862
  - procedure for configuration 854
  - queue 823
  - record announcement 856
  - remove agent from queue 878
  - reports 882
  - restrictions on system features 880
  - Rule editor 772, 826
  - save rule as PDF file 862
  - schedule 771, 825
  - simple wrapup, add wrapup reason 874
  - simple wrapup, delete wrapup reason 875
  - simple wrapup, edit wrapup reasons 874
  - use of DECT phones 881
  - VIP call list 834
  - VIP caller priority 834
  - wallboard display 833
  - wrapup 832
  - wrapup reasons 832
- contact center 809
- Contact Center, Expert mode 1603
- Cordless
  - base stations, Expert mode 1553
  - Multi-SLC, Expert mode 1552
  - SLC, Expert mode 1551
- cordless
  - system-wide, Expert mode 1549
- Cordless phones 80
- cordless solution
  - system configuration 903
- corporate network 718
- cover page editor 559
- CRL (Certificate Revocation List) 946, 969
- CSP (CSTA Service Provider) 1624
- CSTA Message Dispatcher (CMD) 1623
- CSTA protocol 1104
- CSTA Service Provider (CSP) 1624
- CSV file 386
- customer trace log 1265
  - delete 1274
  - display 1273
  - download 1273
  - edit 1273

open 1273  
 Customer Trace Log, Expert mode 1406

## D

data backup (see backup)  
 Data Protection 883  
 data protection 58  
 data security 59  
 Date and Time, Expert mode 1453  
 Day  
   Class of Service Groups, Expert mode 1577  
 DECT phones 80  
 DECT Stations, Expert mode 1528  
 default router 317  
   configure 317  
 Default Router, Expert mode 1497, 1498  
 defer a call 603  
 Denied list, display 696  
 Denied Lists, Expert mode 1579  
 departments 525  
 Departments, Expert mode 1600  
 Deployment and Licensing Client (DLSC), Expert mode 1461  
 Desk Sharing 899  
 desktop dialer 484, 529  
 Destination Codec Parameters, Expert mode 1513  
 Device Statistics, Expert mode 1592  
 Devices, Expert mode 1588  
 DHCP Mode, Expert mode 1490  
 DHCP relay agent  
   configure 309  
 diagnosis log 1287  
   delete 1292  
   download 1291  
   open 1291  
 diagnosis logs 1260  
   download 1262  
 Diagnosis Logs, Expert mode 1416, 1421  
 diagnosis protocol 1260  
   download 1262  
 dial pause 576  
 dial plan 107, 187, 384, 711  
   delete 387  
   edit 387  
   import 388  
 Dial Plan, Expert mode 1505  
 Dial Rule, Expert mode 1507  
 dialable call number format 464  
 Dial-In Control Server 718  
 dial-in number  
   conference 465  
 dial-up network status 1206

check 1208  
 DID Extensions, Expert mode 1544  
 digit dialing 569  
 digit transmission 709  
   select 710  
 digital loopback 1264  
 Digital Loopback, Expert mode 1405  
 digital signature 945  
 direct answering 577  
 Direct Station Select (DSS) key 577  
 Directories (UC Suite) 507  
 directories (UC Smart) 454  
 directory  
   instant message 469  
 DISA, Expert mode 1442  
 discreet call (whisper) 591  
 Display Conventions 44  
 Display, Expert mode 1439  
 disposal 55  
 DLI Maintenance, Expert mode 1423  
 DLS Notification, Expert mode 1424  
 DLSC CA Certificate, Expert mode 1463  
 DLSC Client Certificate, Expert mode 1462  
 DNS (Domain Name Service)  
   define server 316  
 DNS name 338  
 DNS server 316  
 DNS Server, Expert mode 1497  
 Do Not Disturb 603  
 download (see update)  
 DSL (Digital Subscriber Line) 325  
 DSP channels, planning 1632  
 DSS key 577  
 DSS server 1625  
 dual-mode telephony 893  
 DynDNS 315  
 DynDNS (Dynamic Domain Name Service) 338  
 DynDNS service 338  
   configure 339, 362, 363, 364, 919  
 DynDNS Service, Expert mode 1450

## E

E.164 numbering 990  
 E112 emergency call service 760  
 E911 emergency call service 756  
 edit a phone number 570  
 electrical environment  
   OpenScape Business S 56  
   OpenScape Business UC Booster Server 56  
 electromagnetic interference 58  
 e-mail  
   notification 479, 562

## Index

- email
    - invitation to conference 465
  - e-mail to SMS 565
  - E-mail, Expert mode 1415
  - e-mail, send 563
  - emergency calls
    - prerequisites 753
  - emergency, what to do 53
  - en-bloc dialing 569
  - Entrance Telephone (Door Opener), Expert mode 1584
  - entrance telephone/door opener 1080
  - ESP header 935
  - Euro-ISDN features 1628
  - event 1285
    - change e-mail settings 1289
    - clear log 1288
    - display reaction table 1289
    - download log 1288
    - edit event logging via a LAN 1288
    - edit reaction settings for an event 1289
    - edit reaction settings for multiple events 1290
    - e-mail settings 1287
    - log entries 1286
    - log file 1286
    - reaction table 1287
  - Event Configuration, Expert mode 1414
  - Event Log, Expert mode 1415
  - event viewer 1264
    - clear the event log 1274
    - display the event log 1273
    - download the event log 1273
    - edit the event log 1273
    - open the event log 1273
  - Events
    - Diagnosis Logs, Expert mode 1416
    - E-mail, Expert mode 1415
    - Event Configuration, Expert mode 1414
    - Event Log, Expert mode 1415
    - Reaction Table, Expert mode 1416
  - events
    - alarm signaling, Expert mode 1417
  - Events, Expert mode 1414
  - EVM, Expert mode 1530
  - exception
    - rule-based call forwarding 506
  - Executive function (see Executive/Secretary configuration)
  - Executive MULAP 660
    - add 666
    - add a member 668
    - delete 667
    - delete a member 668
    - display 667
    - edit 667
    - edit a member 668
    - ring type 662
    - SIP phones 662
  - Executive/Secretary (see Executive/Secretary configuration)
  - Executive/Secretary configuration 643
    - add 650
    - add a fax box 657
    - add a member 656
    - delete 652
    - delete a member 656
    - edit 651
    - edit a member 656
    - edit the properties of a member 657
    - fax box 646
    - ring type 646
    - SIP phones 646
  - Expert mode, Expert mode 1389
  - external call forwarding - no answer 600
  - external directory 512
  - external directory (LDAP) 515
  - External Directory, Expert mode 1602
  - External Providers Config, Expert mode 1602
- ## F
- FastViewer 467, 544
  - favorites list 527
    - instant message 469
  - favorites list (UC Smart) 457
  - fax 549
    - T.38 567
  - fax box 557
  - fax box group 670
    - add a member 674
    - configure 673, 674
    - delete a member 675
    - display 674
    - edit 674
  - fax group (see fax box group)
  - Fax Group 3 405
  - Fax Group 4 402
  - fax headlines, Expert mode 1619
  - fax messages 549, 801
  - Fax Printer 484, 559
  - features
    - voice, network-wide 986
  - File Upload, Expert mode 1611
  - fire safety requirements 57
  - firewall 920, 1133



- fixed call forwarding 594
- Flex Call 613
- Flexible Menus, Expert mode 1447
- Forwarding, Expert mode 1594
- FTP Server, Expert mode 1489
- function keys 407
  - program 408, 445, 446, 448, 452, 453, 479
- functions
  - myPortal 482
  - myPortal for OpenStage 449, 485
  - myPortal for Outlook 484
  - myPortal Smart 449

## G

- Garbage Collection, Expert mode 1423
- Gate View 1622
- Gateway, Expert mode 1449
- Gigaset phones 80
- Global Parameter, Expert mode 1490
- group call 619
  - disable DND for group members 639
  - DND for group member 620
  - enable DND for group members 639
  - of type call waiting, add 637
  - of type call waiting, add a member 638
  - of type call waiting, delete 638
  - of type call waiting, delete a member 638
  - of type call waiting, display 637
  - of type call waiting, edit 638
  - of type group, add 628
  - of type group, add a member 630
  - of type group, delete 630
  - of type group, delete a member 631
  - of type group, edit 629
  - of type RNA (ring no answer), add 637
  - of type RNA (ring no answer), add a member 638
  - of type RNA (ring no answer), delete 638
  - of type RNA (ring no answer), delete a member 639
  - of type RNA (ring no answer), display 638
  - of type RNA (ring no answer), edit 638
  - ring type 622
  - SIP phones 622
  - voicemail box 620
- Group Members, Expert mode 1556
- groups 617
- Groups, Expert mode 1601
- Groups/Hunt groups, Expert mode 1553

## H

- H.323 Stack Trace 1266
- H.323 stack trace
  - clear log 1278

- display the configuration 1277
- download log 1278
- edit modules 1278
- edit the configuration 1277
- open log 1278
- H.323 Stack Trace, Expert mode 1410
- hardware configuration of OpenScape Office MX
  - display 442
- hardware, replace 298
- hold 586
- Host Name, Expert mode 1484, 1494
- Hot Desking 899
- hoteling 613
- hotline 754
- hotline after timeout 754
- hunt group 623
  - add 631
  - add a member 634
  - delete 634
  - delete a member 634
  - edit 632
  - ring type 625
  - SIP phones 625
  - voicemail 623
- HW Modules, Expert mode 1589

## I

- ICMP (Internet Control Message Protocol) 1225
- IKE SA 944
- IM (instant message) 469
- image file 1185
- Incoming Calls
  - Call Forwarding, Expert mode 1563
  - Call Pickup, Expert mode 1560
  - Group Members, Expert mode 1556
  - Groups/Hunt groups, Expert mode 1553
  - Team/top, Expert mode 1557
  - UCD, Expert mode 1560
- Incoming Calls, Expert mode 1553
- Individual Speed Dialing (ISD) 576
- initiating a restart of OpenScape Business 1199
- installation 104, 183, 233
- instant message 469, 547
- instant messages 801
- instant messaging 547, 801
- Intercept/Attendant/Hotline, Expert mode 1443
- internal directory (UC Smart) 456
- internal directory (UC Suite) 510
- internal Music On Hold 1165, 1168
- internal paging 675
  - transfer call 676
- Internet access 325

## Index

- configuration 326
- configure via a preconfigured ISP 331
- configure via the standard ISP PPPoE 334
- configure via the standard ISP PPTP 336
  - via an external Internet modem 330
  - via an external Internet router 327
- Internet modem 330
- Internet router 327
- Internet telephony 343
- Internet Telephony Service Provider (ITSP) 148, 206, 343, 344
- Internet Telephony Service Provider, Expert mode 1514
- inventory management 1206
- inventory of OpenScape Office LX/HX
  - check 303
- inventory, OpenScape Business S 1212
  - check 1214
- inventory, OpenScape Business X 1211
- inventory, OpenScape Business X3/X5/X8
  - check 1212
- invitation
  - conference 465
- IP Address Pools, Expert mode 1491
- IP address scheme 108, 187
- IP addresses 1207
  - display an overview 1210
- IP client (see IP stations)
- IP Clients, Expert mode 1523, 1547
- IP Diagnostics
  - Mainboard, Expert mode 1425, 1426
- IP Diagnostics, Expert mode 1425
- IP gateway address, Expert mode 1395
- IP Mobility 899
- IP stations 397
- IPSec tunnel 943
- ISDN card 402
- ISDN modem 402
- ISDN outside line
  - configure 366
- ISDN parameters, Expert mode 1576
- ISDN phone 402
- ISDN stations 402
- ISDN Stations, Expert mode 1526
- ISDN trunk
  - selective seizure 719
- ITSP (Internet Telephony Service Provider) 343
- ITSP status 1206
  - check 1209
- IVM 1623
- IVM, Expert mode 1529

## J

- Java 1133
- Java Runtime Environment (JRE) 105, 184
- journal
  - retention period 527
- journal (UC Smart) 464
- journal (UC Suite) 527

## K

- key combination for the Desktop Dialer 529
- key programming 407
- Key Programming, Expert mode 1548
- keypad dial 569

## L

- LAN 1 (WAN), Expert mode 1484
- LAN 1, Expert mode 1495
- LAN 2, Expert mode 1488, 1495
- LAN 3 (Admin), Expert mode 1489
- LAN requirements 988
- languages 81
- Last active Leases, Expert mode 1493
- LCR
  - Classes Of Service, Expert mode 1504
  - Dial Rule, Expert mode 1507
  - LCR flags, Expert mode 1504
  - Multisite, Expert mode 1508
  - Plan, Expert mode 1505
  - Routing Table, Expert mode 1505
- LCR (Least Cost Routing) 707
  - assign/change Class of Service 715
  - class of service 715
  - dial plan 711
  - edit the dial plan 712
  - edit the outdial rules 717
  - edit the routing table 713
  - functionality 708
  - outdial rules 715
  - routing table 713
- LCR flags, Expert mode 1504
- LDAP connection 1133
- LDAP, Expert mode 1445
- license 258
  - activate via a license file 272
  - activate via license authorization code 272, 1339
  - display information 290, 291, 292, 293, 303
  - update 299
- License Authorization Code (LAC) 270, 280
- license component trace 1267
  - edit 1279
- License Component trace, Expert mode 1411
- license file 270, 280

- license server (CLS) 299
  - edit the IP address 174, 222, 276, 278, 286, 288, 294, 295, 296, 297, 300
- licensing procedure 279
- lightning protection requirements 57
- Lightweight CA 946
- Lightweight CA, Expert mode 1466
- live call recording (voice recording) 592
- Load to Gateway, Expert mode 1390
- load to gateway, Expert mode 1391
- locking the phone 706
- loudspeaker 405
- LXV3, Expert mode 1622

## M

- M5T trace component 1265
  - display 1274
  - edit 1275
  - start 1275
  - stop 1275
- M5T Trace Components, Expert mode 1406
- Mail Exchange entry 338
- Mail Exchanger 338, 339
  - define 342
- Mainboard, Expert mode 1425
- Maintenance, Expert mode 1390, 1622
- Manager E 101
- manual action 1260
- mapping (presence status, UC Suite) 502
- MCL Single Stage 718
- MCL Two-Stage 718
- MEB (Media Extension Bridge) 1625
- Media Extension Bridge (MEB) 1625
- Media Stream Control (MSC), Expert mode 1589
- Mediatix 4102S 80
- medium, backup (see backup medium)
- message overview 801
- message texts 609
- messages
  - manage 800
- min network supplier 718
- mobile logon 899
- mobile PIN 613
- mobile user logon 899
- mobility
  - configure mobile phones for GSM 895
  - delete a station 899
- Mobility Clients, Expert mode 1544
- Mobility Entry 888
  - feature codes 889
- Mobility Entry stations
  - conferencing 465, 532, 539, 540, 542, 543

- modem 405
- MoH 1165, 1168
- MSC Statistics, Expert mode 1592
- multilingual text output 1164
- multi-location 982
- Multi-SLC, Expert mode 1552
- multi-user chat 1131
- music on hold 1165, 1168
- Music On Hold (MOH) 687
- Music On Hold (MOH) for call distribution 687
- MX record 338
- myAgent
  - prerequisites 811
- myPortal
  - functions 482
  - presence status 482
- myPortal for OpenStage
  - functions 449, 485
  - presence status 449, 485
- myPortal for Outlook
  - functions 484
- myPortal to go
  - prerequisites 887
- myPortal Smart
  - functions 449
- myReports
  - reset administrator password 815
  - user roles 813

## N

- NAT (Network Address Translation) 923
- NAT rule
  - configure 924
  - configure with NAT table editor 925
  - delete 926
- NAT rules 923
- NAT table editor 925
- NAT, Expert mode 1499
- Native SIP Server Trunk, Expert mode 1520
- NCP client
  - activate, deactivate 954
  - provisioning 954
- network
  - heterogeneous, hybrid 981
  - homogeneous, native 981
  - license 987
- network carriers 718
- network connection check
  - ping 1225
  - using traceroute 1226
- network connection, check 1225
- Network Interfaces

## Index

- Application Board, Expert mode 1494, 1495
  - Expert mode 1483
  - Mainboard, Expert mode 1484, 1488, 1489, 1490, 1491, 1492, 1493, 1494
- network parameters (LAN, WAN) 987
- network plan 981
- networking
  - remove nodes from internetwork 1073
- Night
  - Class of Service Groups, Expert mode 1578
- Night Service, Expert mode 1580
- Nodes, Expert mode 1518
- notes on using myAgent and UC Suite clients
  - simultaneously 817
- notification
  - fax message 562
  - voicemail 479, 562
- notification service 479, 562
- numbering
  - closed 989
  - open 990

## O

- Online User 1323
  - starting 1224, 1324
- Online User, Expert mode 1427
- Online Users 1427
- open conference 543
- Open Directory Service 1120, 1133
  - Basic Settings, Expert mode 1621
  - Data sources, Expert mode 1621, 1622
  - Maintenance, Expert mode 1622
- Open Directory Service, Expert mode 1620, 1622
- OpenScape Business Assistant 84, 86
- OpenScape Business Cordless (see Cordless Solution)
- OpenScape Business X3R
  - protective grounding 1333, 1335, 1336
- OpenScape Business X5R
  - protective grounding 1333, 1335, 1336
- OpenScape Office MX inventory
  - check 302
- OpenScape Office, Expert mode 1621
- OpenScape Personal Edition 80
- OpenStage 80
- OpenStage Attendant 782
- OpenStage Gate View 1087
- operating conditions (environmental, mechanical)
  - OpenScape Business S 61
  - OpenScape Business UC Booster Server 61
  - OpenScape Business X3, X5, X8 61
- operating instructions 43

- optiPoint 80
- Out of Service, Expert mode 1402
- outdial rules 715
- outside line
  - configure ISDN outside line 366
- override 607

## P

- padding 935
- parking 586
- path optimization 991
- path replacement 991
- Payload
  - Devices, Expert mode 1588
  - HW Modules, Expert mode 1589
  - Media Stream Control (MSC), Expert mode 1589
- payload SA 944
- Payload, Expert mode 1588
- PC clients 80
- PDF file
  - fax message 557
  - notification 562
- Peer Certificates, Expert mode 1469
- permanent conference 465, 542
- phone image
  - deploy to device, Expert mode 1398
  - Load, Expert mode 1397
- phone images
  - Deploy, Expert mode 1398
- phone lock, individual 706
- phone logo
  - Load, Expert mode 1399
- phone numbers
  - import 388
- Phone Parameter Deployment, Expert mode 1458
- PIN for activating a shutdown 1203
- Ping, Expert mode 1426
- PKI server
  - add 968
  - display 967
- Platform Diagnostics, Expert mode 1424
- port 1133
- Port Configuration, Expert mode 1391
- Port Management, Expert mode 1454
- port/board status, Expert mode 1402
- ports 921
  - configure port opening 922, 1070
  - port administration 922
- power management, Expert mode 1459
- power supply circuit and connection
  - OpenScape Business S 56
  - OpenScape Business UC Booster Server 56

- PPP Log, Expert mode 1500
- prerequisites for Application Launcher 1133
- prerequisites for myAgent 811
- prerequisites for myPortal for OpenStage 451, 489
- prerequisites for myPortal to go 887
- prerequisites for myReports 815
- presence (UC Smart) 454
- presence (UC Suite) 502
- presence (UC Smart) 454
- presence status 449, 482, 485
  - call forwarding 506
- Presence Status (UC Smart) 454
- presence status (UC Suite) 502
- pre-shared keys 944
- prevention of speaker calls for stations
  - disabling 578
  - enabling 578
- prevention of voice calling for stations 577
- Primary Rate Interface 718
- prioritization of outside lines (trunks) 382
- priority classes 394
- private trunk 580
- profile with configuration data for Application Launcher 1133
- profiles
  - add members 433
  - create new profile 432
  - delete members 434
  - display 433
  - display members 433
  - editing 436
  - export all profiles 437, 918
  - export single profile 435
  - import all profiles 437, 918
  - import single profile 435
  - subscribers 431
- Profiles, Expert mode 1617
- Profiles/Templates, Expert mode 1542
- proper use of communication systems and servers 54
- PSTN Peers, Expert mode 1500
- PSTN, Expert mode 1500
- Public Instant Messaging 1131
- Public Key Infrastructure (PKI), Expert mode 1480
- public phone numbers in the network 990

## Q

- QSIG Features, Expert mode 1575
- Quality of Service (QoS) 394
  - configuring 396
- Quality of Service, Expert Mode 1452
- Quality of Service, Expert mode 1504

## R

- radio frequency interference 58
- RAS user 397
- Reaction Table, Expert mode 1416
- Read Communities, Expert mode 1419
- record 530
- recycling 55
- redialing 571
- rejecting calls 602
- reload of the UC Booster Card 1204
- reloading OpenScape Business 1200
- relocate 613
- remote access 1317
  - configure PC with Windows 7 1320
  - disable 1323
  - enable via Internet access with a fixed IP address 173, 175, 176, 177, 221, 223, 224, 225, 1321
  - enable via Internet access without a fixed IP address 1322
  - enable via ISDN 1318
  - PC configuration 1318
- remote services 1310
- Restart / Reload
  - Restart / Reload, Expert mode 1418
- Restart / Reload, Expert mode 1417, 1418
- restarting OpenScape Business 1199
- restore 1175, 1183
- restore (see restore)
- ringing assignment 600
- ringing group on 601
- Route, Expert mode 1568
- routes 365, 371
  - add direction prefix incoming 373, 378
  - assign codes 375
  - assign Names 374
  - configure number and type, outgoing 377
  - configure the call number type 377
  - enter a second CO code 378
  - enter an overflow route 375
  - enter PABX number 376
- Routing
  - IP Routing, Expert mode 1496, 1497, 1498
  - NAT, Expert mode 1499
  - PSTN, Expert mode 1500
- routing 317
- routing table 713
- Routing Table, Expert mode 1505
- Routing, Expert mode 1496, 1518
- RPCAP daemon 1284
  - disable 1285

## Index

- enable 1284
- rpcap Daemon, Expert mode 1413
- rule 506

## S

- safety information 44
- safety information for Australia 49
- safety information for Brazil 50
- safety information for Canada 52
- safety information for the U.S. 50
- scheduled conference 465, 540
- Schedules, Expert mode 1610
- scope of the voicemail box 549
- Secretary function (see Executive/Secretary configuration)
- Secure Trace 1265
- secure trace
  - change passphrase 1276
  - change password 1276
  - import certificate from X.509 file 1277
  - import X.509 file 1277
  - start 1275
  - stop 1275, 1276
- Secure Trace Certificate, Expert mode 1407
- Secure Trace Settings, Expert mode 1407
- secure trace state
  - query status 1276
- Secure Trace, Expert mode 1406
- Security
  - Application Firewall, Expert mode 1461
  - Deployment and Licensing Client (DLSC), Expert mode 1461
  - Deployment- und Licensing Client (DLSC), Expert mode 1462, 1463
  - Signaling and Payload Encryption (SPE), Expert mode 1464, 1465
  - SQL Security, Expert mode 1483
  - SSL, Expert mode 1480, 1481, 1482
  - VPN, Expert mode 1466, 1467, 1468, 1469, 1471, 1472, 1474, 1477, 1479, 1480
  - Web Security, Expert mode 1483
- Security Associations SA 944
- security checklist 920
- Security, Expert mode 1461
- Server Certificates, Expert mode 1482
- Server, Expert mode 1613
- service codes, Expert mode 1448
- services, block (only LX) 928
- shutdown
  - PIN for activation 1203
- shutdown of OpenScape Business X 1202
- Signaling and Payload Encryption
  - activate SPE support 931
  - deactivate SPE support 931
- Signaling and Payload Encryption (SPE) 929
- Signaling and Payload Encryption (SPE), Expert mode 1464
- single location 982
- SIP client 397
- SIP Interconnection, Expert mode 1518
- SIP Parameters, Expert mode 1509
- SIP Phones 80
- Site List, Expert mode 1612
- Site of Operations, Expert mode 1596
- skin settings, Expert mode 1619
- SLC, Expert mode 1551
- SmartVM, Expert mode 1392, 1393, 1585
- SMS
  - notification 562
- SMS notification 565
- SMS template 565
- SNMP
  - Communities, Expert mode 1419, 1420
  - Traps, Expert mode 1420
- SNMP (Simple Network Management Protocol) 1226
  - add a community 1257
  - communities 1227
  - delete a community 1258
  - display communities 1257
  - display trap details 1260
  - display traps 1259
  - edit a community 1258
  - Management Information Database (MIB) 1226
  - traps 1227
- SNMP Statistics, Expert mode 1592
- SNMP, Expert mode 1419
- SNTP Settings, Expert mode 1453
- software activation 1184
- Software Image
  - System Software, Expert mode 1395, 1396, 1397
- Software Image, Expert mode 1395, 1400
- software transfer 1184
- software update (see update)
- software updates 1184
- SPE CA Certificates, Expert mode 1465
- SPE Certificate, Expert mode 1465
- speaker call 577
- speaker call for groups 675
- Special Days, Expert mode 1582
- Speed Dials, Expert mode 1447
- Speed dials, Expert mode 1621
- SQL Security, Expert mode 1483
- SSDP (Smart Services Delivery Platform) 1311

- configure PIN for activating/deactivating the service plugin 1316
  - configure Service Plugin for customer network with proxy 1313
  - deactivate Service Plugin 1315
  - reset Service Plugin 1315
  - SSL (Secure Socket Layer) 968
    - activating a certificate 973
    - display certificates 927, 928, 971
    - exporting a certificate 972
    - generating a CA certificate 969
    - generating a certificate request 970
    - generating a self-signed certificate 970
    - importing a server certificate 971
    - importing an updated certificate 972
    - removing a certificate 972
  - standards 1626
  - Static IP Addresses, Expert mode 1492
  - static routes 317
    - add 318, 321, 322, 323
    - delete 319
  - Static Routes, Expert mode 1496, 1498
  - Station
    - Key Programming, Expert mode 1548
    - Stations, Expert mode 1521, 1523, 1525, 1526, 1527, 1528, 1529, 1530, 1531, 1542, 1544
  - station data
    - import 388
  - station flag
    - call waiting rejection on 639
    - prevention of voice calling off 578
  - Station Parameters, Expert mode 1532
  - station status 1206
  - Stations
    - Overview, Expert mode 1547
    - Station, Expert mode 1532
  - stations 384
    - analog 405
    - configure with wizards 410
    - IP 397
    - ISDN 402
    - Station, Expert mode 1541
  - Stations, Expert mode 1521, 1577, 1594
  - Statistics
    - Gateway Statics, Expert mode 1592
    - Gateway Statistics, Expert mode 1592
    - SNMP Statistics, Expert mode 1592
    - Telephony Statistics, Expert mode 1593, 1594
  - Statistics, Expert mode 1592
  - status of stations
    - check 1207
  - status of the communication system 1206
  - status-based voicemail announcements 549
  - STUN (Simple Traversal of UDP through NAT) 363
  - suffix dialing 572
  - survivability 1071
  - system client 397
  - system connection 1133
  - system directory 457
  - system directory (UC Suite) 517
  - system flag
    - call pickup after automatic recall 636, 991
    - calling number in pick-up groups / ringing groups / CFN / RNA 635
    - SPE support 931
    - warning signal for call pickup groups 636
  - System Flags, Expert mode 1427
  - system language for voicemail 549
  - System Speed Dialing (SSD) 572
  - System Texts, Expert mode 1593
  - System-wide, Expert mode 1549
- ## T
- T.38 Fax 567
  - Take Over Write Token, Expert mode 1425
  - TCP dump 1283
    - delete 1284
    - start 1283
    - stop 1283
  - TCP Dump, Expert mode 1413
  - team (see team configuration)
  - team configuration 640
    - add 647
    - add a fax box 655
    - add a member 653
    - change programmed feature keys 655
    - delete 649
    - delete a member 653
    - edit 649
    - edit members 654
    - edit the properties of a member 654
    - fax box 642
    - ring type 642
    - SIP phones 642
  - team function (see team configuration)
  - team group 640
    - add 648
    - add a fax box 655
    - add a member 653
    - change programmed feature keys 655
    - delete 650
    - delete a member 653
    - edit 649
    - edit members 654

## Index

- edit the properties of a member 654
- fax box 642
- ring type 642
- SIP phones 642
- Team/top, Expert mode 1557
- Telefon-Logo
  - Verteilen, Experten-Modus 1399
- Telephones 80
- Telephony, Expert mode 1427
- teleworking 505, 912
- Templates, Expert mode 1601
- Terminal server and Citrix server environments 482
- Texts, Expert mode 1446
- The 569
- TIFF file
  - fax message 557
  - notification 562
- time parameters
  - monitor a UCD call on an analog line 690
  - monitor an unscreened transfer to a UCD group 689
- Time Parameters, Expert mode 1434
- timed reminder 616
- toggle/connect 588
- toll restriction 691
  - add phone number to allowed list 695
  - add phone number to Denied list 696
  - configure 694, 695, 699
  - display Allowed list 697
  - display Denied list 696
  - edit filter for Denied List 697
- top group 643
  - add 650
  - add a fax box 657
  - add a member 656
  - delete 652
  - delete a member 656
  - edit 651
  - edit members 656
  - edit the properties of a member 657
  - fax box 646
  - ring type 646
  - SIP phones 646
- topics, types 43
- trace 1263
  - clear log 1270
  - display output interfaces 1272
  - display the format configuration 1272
  - download log 1269
  - edit output interfaces 1272
  - edit the format configuration 1272
  - format configuration 1263
  - log 1264
  - output interfaces 1264
- trace component 1269
  - display 1281
  - display details 1281
  - edit 1282
  - start 1281
  - stop 1281
  - stop all components 1282
- Trace Components, Expert mode 1412
- Trace Console Output, Expert mode 1425
- Trace Format Configuration, Expert mode 1403
- Trace Log, Expert mode 1405
- Trace Output Interfaces, Expert mode 1404
- trace profile 1267
  - add 1280
  - display 1270
  - display details 1279
  - start 1271
  - stop 1271
  - stop all profiles 1280
- Trace Profiles, Expert mode 1412
- Traceroute, Expert mode 1426
- Traces
  - Auto DSP Trace, Expert mode 1414
  - Customer Trace Log, Expert mode 1406
  - Digital Loopback, Expert mode 1405
  - H.323 Stack Trace, Expert mode 1410
  - License Component, Expert mode 1411
  - M5T Trace Components, Expert mode 1406
  - rpcap Daemon, Expert mode 1413
  - Secure Trace, Expert mode 1406, 1407
  - TCP Dump, Expert mode 1413
  - Trace Components, Expert mode 1412
  - Trace Format Configuration, Expert mode 1403
  - Trace Log, Expert mode 1405
  - Trace Output Interfaces, Expert mode 1404
  - Trace Profiles, Expert mode 1412
- traces
  - call monitoring, Expert mode 1408
- Traces, Expert mode 1403
- transfer calls 588
- transfer to group from announcement 676
- transfer, software (see software transfer)
- translation of station numbers to names 585
- transmission of customer-specific call number information 584
- Trap Communities, Expert mode 1420
- Traps, Expert mode 1420
- trunk queuing 579
- trunk release for emergency call 755
- Trunk Status, Expert mode 1593



- trunks 365
  - assign MSNs 369
  - change the protocol 370, 371
  - configure the type of seizure 376, 380, 382
  - edit codes 368, 369
  - edit routes 374
  - type of seizure 372
- Trunks, Expert mode 1566
- Trunks/Routing
  - Assign MSN, Expert mode 1576
  - ISDN parameters, Expert mode 1576
  - QSIG Features, Expert mode 1575
  - Route, Expert mode 1568
  - Trunks, Expert mode 1566
- Trunks/Routing, Expert mode 1565
- U**
- UC Application
  - restart 1205
- UC Applications, Expert mode 1541
- UC Booster Card
  - restart 1203
- UC Smart
  - Basic Settings 1597
  - query status 1309
  - Status 1598
  - status 1309
  - User Management 1597
- UC Smart Client 448
- UC Smart, Expert mode 1597
- UC Suite 1599
  - client logs 1299
  - Conferencing, Expert mode 1612
  - configure e-mail notifications for system errors 1305
  - configure retention period for contact center data 1309
  - configure retention period for log files 1308
  - configure storage path for client log files 1301
  - configure time for maintenance 1308
  - Contact Center, Expert mode 1603
  - Departments, Expert mode 1600
  - disable recording of system logs 1300
  - disable saving of client logs on system hard disk 1302
  - download client logs 1303
  - e-mail notification 1303
  - enable recording of system logs 1299
  - enable saving of client logs on system hard disk 1302
  - External Directory, Expert mode 1602
  - External Providers Config, Expert mode 1602
  - Fax Headlines, Expert mode 1619
  - File Upload, Expert mode 1611
  - Groups, Expert mode 1601
  - performing system maintenance immediately 1308
  - Profiles, Expert mode 1617
  - Schedules, Expert mode 1610
  - Server, Expert mode 1613
  - Site List, Expert mode 1612
  - skin settings, Expert Mode 1619
  - Templates, Expert mode 1601
  - User Directory, Expert mode 1599
- UC Suite Clients 482
- UC Suite, Expert mode 1598
- UC Suite
  - disable recording of client logs on station-specific basis 1300
  - disable recording of client logs on system-wide basis 1300
  - enable recording of client logs on station-specific basis 1301
  - enable recording of client logs on system-wide basis 1300
  - maintenance 1298, 1306
  - monitoring 1298
  - notification 1304
  - system logs 1298
- UCD (Uniform Call Distribution) (see call distribution)
- UCD Agents, Expert mode 1593
- UCD, Expert mode 1560
- UP0 Stations, Expert mode 1521
- update 1184
  - custom 1193
- update licenses 298
- Update Timer DNS Names, Expert mode 1451
- Update via File Upload, Expert mode 1396
- Update via Internet, Expert mode 1395
- Update via USB Stick, Expert mode 1397
- update, full
  - start in the background 1191
  - start with progress indicator 1188, 1198
- update, software (see software updates)
- upgrade 1184
- user (station) profiles 431
- user buttons 800
  - layout 800
- User Directory, Expert mode 1599
- user profiles for the UC Suite 498
- users of UC Smart
  - edit data 452, 453, 479
- users of UC Suite
  - change length of password 498
  - change password 497

## Index

- change presence status 497
- configure as agents 496
- edit data 495
- users of UC Suite 493
  - reset 496

## V

- virtual conference room 465
- Virtual Stations, Expert mode 1531
- Voice Gateway
  - Codec Parameters, Expert mode 1511
  - Destination Codec Parameters, Expert mode 1513
  - Internet Telephony Service Provider, Expert mode 1514
  - Networking, Expert mode 1518
  - SIP Interconnection, Expert mode 1518, 1520
  - SIP Parameters, Expert mode 1509
- Voice Gateway, Expert mode 1509
- voicemail 549
  - call pickup 549
  - save 549
  - status-based announcements 549
- voicemail box 549
- voicemail box (UC Smart) 471
- voicemail box, see voicemail 549
- voicemail group 669
  - add 670
  - add a member 672
  - delete 671
  - delete a member 672
  - display 671
  - edit 671
  - edit members 672
- voicemail messages 549, 801
- voicemails (UC Smart) 471
- VPN
  - authentication 944
  - bandwidths 934
  - clients 951
  - security mechanisms 943
- VPN (Virtual Private Network) 933
  - end-to-site 934
  - site-to-site 933
- VPN active services
  - display a special service 957
  - display all services 957
- VPN active tunnels
  - display 959
  - display rules 960
- VPN certificates 945
  - display 948
  - generating a certificate request 949

- generating a Lightweight CA certificate 947
- import 950
- importing a trusted CA certificate 948
- VPN configured services
  - change 958
  - delete 959
  - display all services 958
  - rename 959
- VPN configured tunnels
  - add 962
  - display 961
  - display rules 961
- VPN rules
  - add a configured rule 965
  - add for opposite direction 966
  - delete 967
  - display a special active rule 964
  - display all active rules 964
  - display all configured rules 964
  - edit 966
- VPN status 1207
  - check 1209
- VPN, Expert mode 1466

## W

- WAN 338
- warnings 44
  - caution 47
  - danger 46
  - note 48
  - warning 46
- WAV file
  - notification 479, 562
- Wave file 1165, 1168
- Wave-Datei 1165, 1168
- WBM 84
  - home page 84
- Web Collaboration 544
- web collaboration 467
- Web Collaboration, Expert mode 1620
- Web Security, Expert mode 1483
- Web Services 1133
  - Web Collaboration, Expert mode 1620
  - XMPP, Expert mode 1619
- Web Services Interface 1119
- Web Services, Expert mode 1619
- Web-Based Management 84
- wizards 94
- WLAN phones 80
- Write Communities, Expert mode 1419

**X**

XMPP 1131

XMPP, Expert mode 1619